

3.3V, Low Power, High Speed or Slew Rate Limited, RS-485/RS-422 Transceivers

These Intersil RS-485/RS-422 devices are BiCMOS 3.3V powered, single transceivers that meet both the RS-485 and RS-422 standards for balanced communication. Unlike competitive devices, this Intersil family is specified for 10% tolerance supplies (3V to 3.6V).

The ISL83483 and ISL83488 utilize slew rate limited drivers which reduce EMI, and minimize reflections from improperly terminated transmission lines, or unterminated stubs in multidrop and multipoint applications.

Data rates up to 10Mbps are achievable by using the ISL83485, ISL83490, or ISL83491, which feature higher slew rates.

Logic inputs (e.g., DI and DE) accept signals in excess of 5.5V, making them compatible with 5V logic families.

Receiver (Rx) inputs feature a “fail-safe if open” design, which ensures a logic high output if Rx inputs are floating. All devices present a “single unit load” to the RS-485 bus, which allows up to 32 transceivers on the network.

Driver (Tx) outputs are short circuit protected, even for voltages exceeding the power supply voltage. Additionally, on-chip thermal shutdown circuitry disables the Tx outputs to prevent damage if power dissipation becomes excessive.

The ISL83488, ISL83490, ISL83491 are configured for full duplex (separate Rx input and Tx output pins) applications. The ISL83488 and ISL83490 are offered in space saving 8 lead packages for applications not requiring Rx and Tx output disable functions (e.g., point-to-point and RS-422). Half duplex configurations (ISL83483, ISL83485) multiplex the Rx inputs and Tx outputs to provide transceivers with Rx and Tx disable functions in 8 lead packages.

Features

- Operate from a Single +3.3V Supply (10% Tolerance)
- Interoperable with 5V Logic
- High Data Rates up to 10Mbps
- Single Unit Load Allows up to 32 Devices on the Bus
- Slew Rate Limited Versions for Error Free Data Transmission (ISL83483, ISL83488) up to 250kbps
- Low Current Shutdown Mode (ISL83483, ISL83485, ISL83491). 15nA
- -7V to +12V Common Mode Input Voltage Range
- Three State Rx and Tx Outputs (Except ISL83488, ISL83490)
- 10ns Propagation Delay, 1ns Skew (ISL83485, ISL83490, ISL83491)
- Full Duplex and Half Duplex Pinouts
- Current Limiting and Thermal Shutdown for driver Overload Protection
- Pb-free available

Applications

- Factory Automation
- Security Networks
- Building Environmental Control Systems
- Industrial/Process Control Networks
- Level Translators (e.g., RS-232 to RS-422)
- RS-232 “Extension Cords”

TABLE 1. SUMMARY OF FEATURES

PART NUMBER	HALF/FULL DUPLEX	DATA RATE (Mbps)	SLEW-RATE LIMITED?	RECEIVER/DRIVER ENABLE?	QUIESCENT I_{CC} (mA)	LOW POWER SHUTDOWN?	PIN COUNT
ISL83483	Half	0.25	Yes	Yes	0.65	Yes	8
ISL83485	Half	10	No	Yes	0.65	Yes	8
ISL83488	Full	0.25	Yes	No	0.65	No	8
ISL83490	Full	10	No	No	0.65	No	8
ISL83491	Full	10	No	Yes	0.65	Yes	14

Pinouts

ISL83483, ISL83485 (PDIP, SOIC)
TOP VIEW

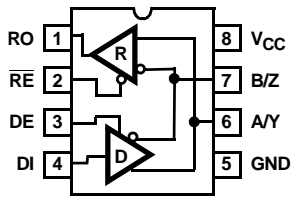

ISL83488, ISL83490 (PDIP, SOIC)
TOP VIEW

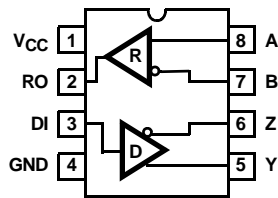

ISL83491 (PDIP, SOIC)
TOP VIEW

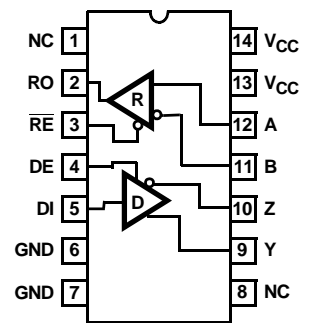

Ordering Information

PART NO. (BRAND)	TEMP. RANGE (°C)	PACKAGE	PKG. DWG. #
ISL83483IB* (83483IB)	-40 to 85	8 Ld SOIC	M8.15
ISL83483IBZ* (83483IB) (Note)	-40 to 85	8 Ld SOIC (Pb-free)	M8.15
ISL83483IP	-40 to 85	8 Ld PDIP	E8.3
ISL83485IB* (83485IB)	-40 to 85	8 Ld SOIC	M8.15
ISL83485IBZ* (83485IB) (Note)	-40 to 85	8 Ld SOIC (Pb-free)	M8.15
ISL83485IP	-40 to 85	8 Ld PDIP	E8.3
ISL83488IB* (83488IB)	-40 to 85	8 Ld SOIC	M8.15
ISL83488IBZ* (83488IB) (Note)	-40 to 85	8 Ld SOIC (Pb-free)	M8.15
ISL83488IP	-40 to 85	8 Ld PDIP	E8.3
ISL83490IB* (83490IB)	-40 to 85	8 Ld SOIC	M8.15
ISL83490IBZ* (83490IB) (Note)	-40 to 85	8 Ld SOIC (Pb-free)	M8.15
ISL83490IP	-40 to 85	8 Ld PDIP	E8.3
ISL83491IB* (83491IB)	-40 to 85	14 Ld SOIC	M14.15
ISL83491IBZ* (83491IB) (Note)	-40 to 85	14 Ld SOIC (Pb-free)	M14.15
ISL83491IP	-40 to 85	14 Ld PDIP	E14.3

*Add "-T" suffix to part number for tape and reel packaging.

NOTE: Intersil Pb-free products employ special Pb-free material sets; molding compounds/die attach materials and 100% matte tin plate termination finish, which is compatible with both SnPb and Pb-free soldering operations. Intersil Pb-free products are MSL classified at Pb-free peak reflow temperatures that meet or exceed the Pb-free requirements of IPC/JEDEC J Std-020B.

Truth Tables

TRANSMITTING				
INPUTS			OUTPUTS	
RE	DE	DI	Z	Y
X	1	1	0	1
X	1	0	1	0
0	0	X	High-Z	High-Z
1	0	X	High-Z *	High-Z *

NOTE: *Shutdown Mode for ISL83483, ISL83485, ISL83491

RECEIVING				
INPUTS				OUTPUT
RE	DE Half Duplex	DE Full Duplex	A-B	RO
0	0	X	≥ +0.2V	1
0	0	X	≤ -0.2V	0
0	0	X	Inputs Open	1
1	0	0	X	High-Z *
1	1	1	X	High-Z

NOTE: *Shutdown Mode for ISL83483, ISL83485, ISL83491

Pin Descriptions

PIN	FUNCTION
RO	Receiver output: If $A > B$ by at least 0.2V, RO is high; If $A < B$ by 0.2V or more, RO is low; RO = High if A and B are unconnected (floating).
\overline{RE}	Receiver output enable. RO is enabled when \overline{RE} is low; RO is high impedance when \overline{RE} is high.
DE	Driver output enable. The driver outputs, Y and Z, are enabled by bringing DE high. They are high impedance when DE is low.
DI	Driver input. A low on DI forces output Y low and output Z high. Similarly, a high on DI forces output Y high and output Z low.
GND	Ground connection.
A/Y	Noninverting receiver input and noninverting driver output. Pin is an input if DE = 0; pin is an output if DE = 1.
B/Z	Inverting receiver input and inverting driver output. Pin is an input if DE = 0; pin is an output if DE = 1.
A	Noninverting receiver input.
B	Inverting receiver input.
Y	Noninverting driver output.
Z	Inverting driver output.
V _{CC}	System power supply input (3V to 3.6V).
NC	No Connection.

Typical Operating Circuits

ISL83483, ISL83485

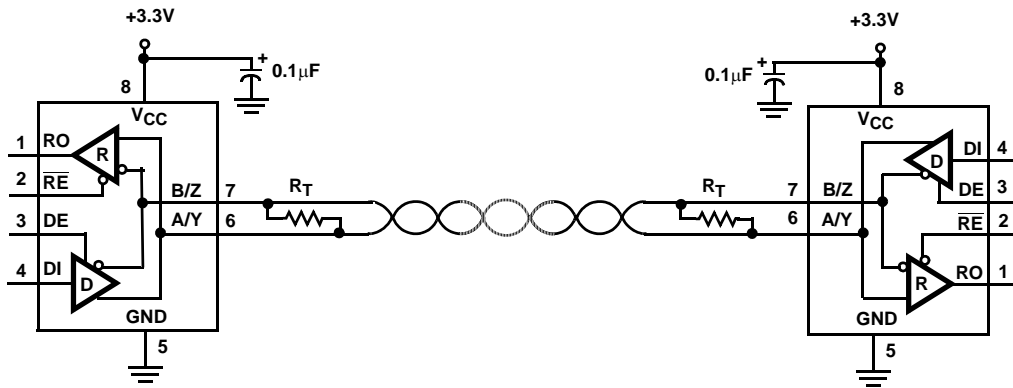

ISL83488, ISL83490

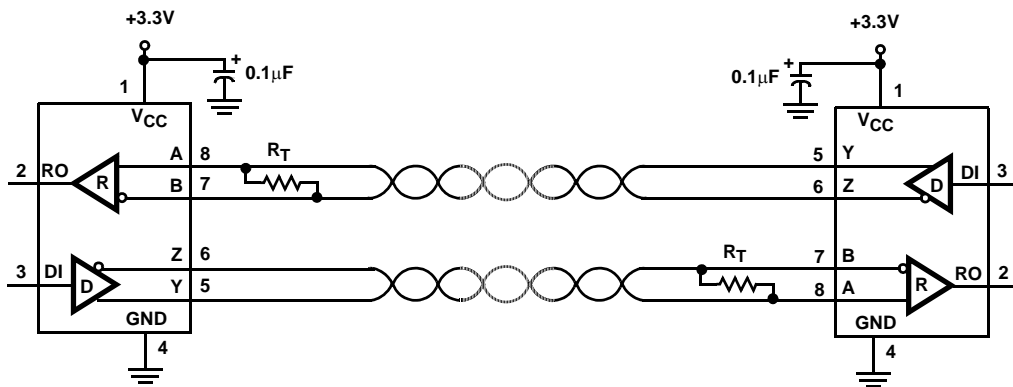

ISL83491

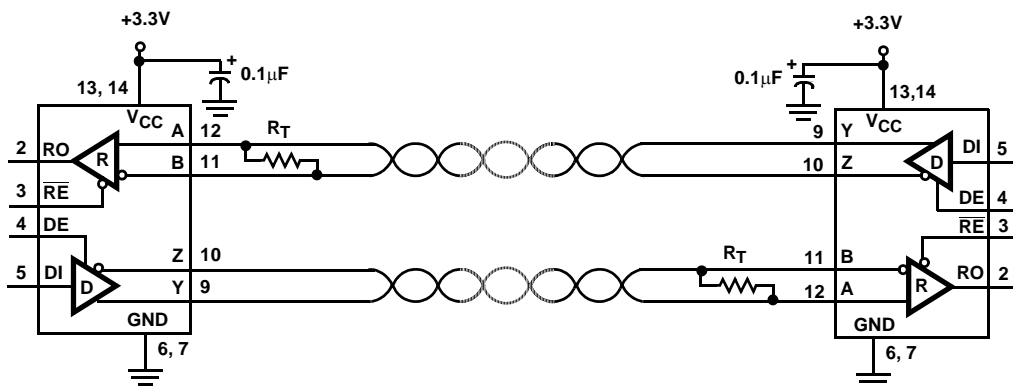

Absolute Maximum Ratings

V _{CC} to Ground	7V
Input Voltages	
DI, DE, RE	-0.5V to +7V
Input/Output Voltages	
A, B, Y, Z	-8V to +12.5V
RO	-0.5V to (V _{CC} + 0.5V)
Short Circuit Duration	
Y, Z	Continuous

Thermal Information

Thermal Resistance (Typical, Note 1)	θ _{JA} (°C/W)
8 Ld SOIC Package	170
8 Ld PDIP Package	140
14 Ld SOIC Package	130
14 Ld PDIP Package	105
Maximum Junction Temperature (Plastic Package)	150°C
Maximum Storage Temperature Range	-65°C to 150°C
Maximum Lead Temperature (Soldering 10s)	300°C (SOIC- Lead Tips Only)

Operating Conditions

Temperature Range	
ISL834XXIX	-40°C to 85°C

CAUTION: Stresses above those listed in "Absolute Maximum Ratings" may cause permanent damage to the device. This is a stress only rating and operation of the device at these or any other conditions above those indicated in the operational sections of this specification is not implied.

NOTE:

- θ_{JA} is measured with the component mounted on a low effective thermal conductivity test board in free air. See Tech Brief TB379 for details.

Electrical Specifications Test Conditions: V_{CC} = 3V to 3.6V; Unless Otherwise Specified. Typicals are at V_{CC} = 3.3V, T_A = 25°C, Note 2

PARAMETER	SYMBOL	TEST CONDITIONS	TEMP (°C)	MIN	TYP	MAX	UNITS	
DC CHARACTERISTICS								
Driver Differential V _{OUT} (no load)	V _{OD1}		Full	-	-	V _{CC}	V	
Driver Differential V _{OUT} (with load)	V _{OD2}	R _L = 100Ω (RS-422) (Figure 1A)	Full	2	2.7	-	V	
		R _L = 54Ω (RS-485) (Figure 1A)	Full	1.5	2.3	V _{CC}	V	
		R _L = 60Ω, -7V ≤ V _{CM} ≤ 12V (Figure 1B)	Full	1.5	2.6	-	V	
Change in Magnitude of Driver Differential V _{OUT} for Complementary Output States	ΔV _{OD}	R _L = 54Ω or 100Ω (Figure 1A)	Full	-	0.01	0.2	V	
Driver Common-Mode V _{OUT}	V _{OC}	R _L = 54Ω or 100Ω (Figure 1A)	Full	-	1.8	3	V	
Change in Magnitude of Driver Common-Mode V _{OUT} for Complementary Output States	ΔV _{OC}	R _L = 54Ω or 100Ω (Figure 1A)	Full	-	0.01	0.2	V	
Logic Input High Voltage	V _{IH}	DE, DI, RE	Full	2	-	-	V	
Logic Input Low Voltage	V _{IL}	DE, DI, RE	Full	-	-	0.8	V	
Logic Input Current	I _{IN1}	DE, DI	Full	-2	-	2	μA	
		RE	Full	-25	-	25	μA	
Input Current (A, B)	I _{IN2}	DE = 0V, V _{CC} = 0V or 3.6V	V _{IN} = 12V	Full	-	0.6	1	mA
			V _{IN} = -7V	Full	-	-0.3	-0.8	mA
Output Leakage Current (Y, Z) (ISL83491)	I _{IN3}	RE = 0V, DE = 0V, V _{CC} = 0V or 3.6V	V _{IN} = 12V	Full	-	14	20	μA
			V _{IN} = -7V	Full	-20	-11	-	μA
Output Leakage Current (Y, Z) in Shutdown Mode (ISL83491)	I _{IN3}	RE = V _{CC} , DE = 0V, V _{CC} = 0V or 3.6V	V _{IN} = 12V	Full	-	0.03	1	μA
			V _{IN} = -7V	Full	-1	-0.01	-	μA
Receiver Differential Threshold Voltage	V _{TH}	-7V ≤ V _{CM} ≤ 12V	Full	-0.2	-	0.2	V	
Receiver Input Hysteresis	ΔV _{TH}	V _{CM} = 0V	25	-	50	-	mV	
Receiver Output High Voltage	V _{OH}	I _O = -4mA, V _{ID} = 200mV	Full	V _{CC} - 0.4	-	-	V	
Receiver Output Low Voltage	V _{OL}	I _O = -4mA, V _{ID} = 200mV	Full	-	-	0.4	V	

ISL83483, ISL83485, ISL83488, ISL83490, ISL83491

Electrical Specifications Test Conditions: $V_{CC} = 3V$ to $3.6V$; Unless Otherwise Specified. Typical values are at $V_{CC} = 3.3V$, $T_A = 25^{\circ}C$, Note 2 (Continued)

PARAMETER	SYMBOL	TEST CONDITIONS	TEMP (°C)	MIN	TYP	MAX	UNITS	
Three-State (high impedance) Receiver Output Current	I_{OZR}	$0.4V \leq V_O \leq 2.4V$	Full	-1	-	1	μA	
Receiver Input Resistance	R_{IN}	$-7V \leq V_{CM} \leq 12V$	Full	12	19	-	$k\Omega$	
No-Load Supply Current (Note 3)	I_{CC}	$DI = 0V$ or V_{CC}	$DE = V_{CC}$, $\overline{RE} = 0V$ or V_{CC}	Full	-	0.75	1.2	mA
			$DE = 0V$, $\overline{RE} = 0V$	Full	-	0.65	1	mA
Shutdown Supply Current (Except ISL83488 and ISL83490)	I_{SHDN}	$DE = 0V$, $\overline{RE} = V_{CC}$, $DI = 0V$ or V_{CC}	Full	-	15	100	nA	
Driver Short-Circuit Current, $V_O =$ High or Low	I_{OSD1}	$DE = V_{CC}$, $-7V \leq V_Y$ or $V_Z \leq 12V$ (Note 4)	Full	-	-	250	mA	
Receiver Short-Circuit Current	I_{OSR}	$0V \leq V_O \leq V_{CC}$	Full	8	-	60	mA	
DRIVER SWITCHING CHARACTERISTICS (ISL83485, ISL83490, ISL83491)								
Maximum Data Rate	f_{MAX}		Full	12	15	-	Mbps	
Driver Differential Output Delay	t_{DD}	$R_{DIFF} = 60\Omega$, $C_L = 15pF$ (Figure 2A)	Full	1	10	35	ns	
Driver Differential Rise or Fall Time	t_R , t_F	$R_{DIFF} = 60\Omega$, $C_L = 15pF$ (Figure 2A)	Full	3	5	20	ns	
Driver Input to Output Delay	t_{PLH} , t_{PHL}	$R_L = 27\Omega$, $C_L = 15pF$ (Figure 2C)	Full	6	10	35	ns	
Driver Output Skew	t_{SKEW}	$R_L = 27\Omega$, $C_L = 15pF$ (Figure 2C)	Full	-	1	8	ns	
Driver Enable to Output High (Except ISL83490)	t_{ZH}	$R_L = 110\Omega$, $C_L = 50pF$, $SW = GND$ (Figure 3), (Note 5)	Full	-	45	90	ns	
Driver Enable to Output Low (Except ISL83490)	t_{ZL}	$R_L = 110\Omega$, $C_L = 50pF$, $SW = V_{CC}$ (Figure 3), (Note 5)	Full	-	45	90	ns	
Driver Disable from Output High (Except ISL83490)	t_{HZ}	$R_L = 110\Omega$, $C_L = 50pF$, $SW = GND$ (Figure 3)	25	-	65	80	ns	
			Full	-	-	110	ns	
Driver Disable from Output Low (Except ISL83490)	t_{LZ}	$R_L = 110\Omega$, $C_L = 50pF$, $SW = V_{CC}$ (Figure 3)	25	-	65	80	ns	
			Full	-	-	110	ns	
Driver Enable from Shutdown to Output High (Except ISL83490)	$t_{ZH(SHDN)}$	$R_L = 110\Omega$, $C_L = 50pF$, $SW = GND$ (Figure 3), (Notes 7, 8)	Full	-	115	150	ns	
Driver Enable from Shutdown to Output Low (Except ISL83490)	$t_{ZL(SHDN)}$	$R_L = 110\Omega$, $C_L = 50pF$, $SW = V_{CC}$ (Figure 3), (Notes 7, 8)	Full	-	115	150	ns	
DRIVER SWITCHING CHARACTERISTICS (ISL83483, ISL83488)								
Maximum Data Rate	f_{MAX}		Full	250	-	-	kpbs	
Driver Differential Output Delay	t_{DD}	$R_{DIFF} = 60\Omega$, $C_L = 15pF$ (Figure 2A)	Full	600	930	1400	ns	
Driver Differential Rise or Fall Time	t_R , t_F	$R_{DIFF} = 60\Omega$, $C_L = 15pF$ (Figure 2A)	Full	400	900	1200	ns	
Driver Input to Output Delay	t_{PLH} , t_{PHL}	$R_L = 27\Omega$, $C_L = 15pF$ (Figure 2C)	25	600	930	1500	ns	
			Full	400	-	1500	ns	
Driver Output Skew	t_{SKEW}	$R_L = 27\Omega$, $C_L = 15pF$ (Figure 2C)	Full	-	140	-	ns	
Driver Enable to Output High (Except ISL83488)	t_{ZH}	$R_L = 110\Omega$, $C_L = 50pF$, $SW = GND$ (Figure 3), (Note 5)	Full	-	385	800	ns	
Driver Enable to Output Low (Except ISL83488)	t_{ZL}	$R_L = 110\Omega$, $C_L = 50pF$, $SW = V_{CC}$ (Figure 3), (Note 5)	Full	-	55	800	ns	
Driver Disable from Output High (Except ISL83488)	t_{HZ}	$R_L = 110\Omega$, $C_L = 50pF$, $SW = GND$ (Figure 3)	25	-	63	80	ns	
			Full	-	-	110	ns	

ISL83483, ISL83485, ISL83488, ISL83490, ISL83491

Electrical Specifications Test Conditions: $V_{CC} = 3V$ to $3.6V$; Unless Otherwise Specified. Typicals are at $V_{CC} = 3.3V$, $T_A = 25^{\circ}C$, Note 2 (Continued)

PARAMETER	SYMBOL	TEST CONDITIONS	TEMP (°C)	MIN	TYP	MAX	UNITS
Driver Disable from Output Low (Except ISL83488)	t_{LZ}	$R_L = 110\Omega$, $C_L = 50pF$, $SW = V_{CC}$ (Figure 3)	25	-	70	80	ns
			Full	-	-	110	ns
Driver Enable from Shutdown to Output High (Except ISL83488)	$t_{ZH}(SHDN)$	$R_L = 110\Omega$, $C_L = 50pF$, $SW = GND$ (Notes 7, 8)	Full	-	450	2000	ns
Driver Enable from Shutdown to Output Low (Except ISL83488)	$t_{ZL}(SHDN)$	$R_L = 110\Omega$, $C_L = 50pF$, $SW = V_{CC}$ (Figure 3), (Notes 7, 8)	Full	-	126	2000	ns
RECEIVER SWITCHING CHARACTERISTICS (All Versions)							
Receiver Input to Output Delay	t_{PLH} , t_{PHL}	(Figure 4)	Full	25	45	90	ns
Receiver Skew $t_{PLH} - t_{PHL}$	t_{SKD}	(Figure 4)	25	-	2	10	ns
			Full	-	2	12	ns
Receiver Enable to Output High (Except ISL83488 and ISL83490)	t_{ZH}	$R_L = 1k\Omega$, $C_L = 15pF$, $SW = GND$ (Figure 5), (Note 6)	Full	-	11	50	ns
Receiver Enable to Output Low (Except ISL83488 and ISL83490)	t_{ZL}	$R_L = 1k\Omega$, $C_L = 15pF$, $SW = V_{CC}$ (Figure 5), (Note 6)	Full	-	11	50	ns
Receiver Disable from Output High (Except ISL83488 and ISL83490)	t_{HZ}	$R_L = 1k\Omega$, $C_L = 15pF$, $SW = GND$ (Figure 5)	Full	-	7	45	ns
Receiver Disable from Output Low (Except ISL83488 and ISL83490)	t_{LZ}	$R_L = 1k\Omega$, $C_L = 15pF$, $SW = V_{CC}$ (Figure 5)	Full	-	7	45	ns
Time to Shutdown (Except ISL83488 and ISL83490)	t_{SHDN}	(Note 7)	Full	80	190	300	ns
Receiver Enable from Shutdown to Output High (Except ISL83488 and ISL83490)	$t_{ZH}(SHDN)$	$R_L = 1k\Omega$, $C_L = 15pF$, $SW = GND$ (Figure 5), (Notes 7, 9)	Full	-	240	600	ns
Receiver Enable from Shutdown to Output Low (Except ISL83488 and ISL83490)	$t_{ZL}(SHDN)$	$R_L = 1k\Omega$, $C_L = 15pF$, $SW = V_{CC}$ (Figure 5), (Notes 7, 9)	Full	-	240	600	ns

NOTES:

2. All currents into device pins are positive; all currents out of device pins are negative. All voltages are referenced to device ground unless otherwise specified.
3. Supply current specification is valid for loaded drivers when $DE = 0V$.
4. Applies to peak current. See "Typical Performance Curves" for more information.
5. When testing the ISL83483, ISL83485, ISL83491, keep $\overline{RE} = 0$ to prevent the device from entering SHDN.
6. When testing the ISL83483, ISL83485, ISL83491, the \overline{RE} signal high time must be short enough (typically <100ns) to prevent the device from entering SHDN.
7. The ISL83483, ISL83485, ISL83491 are put into shutdown by bringing \overline{RE} high and DE low. If the inputs are in this state for less than 80ns, the parts are guaranteed not to enter shutdown. If the inputs are in this state for at least 300ns, the parts are guaranteed to have entered shutdown. See "Low-Power Shutdown Mode" section.
8. Keep $\overline{RE} = V_{CC}$, and set the DE signal low time >300ns to ensure that the device enters SHDN.
9. Set the \overline{RE} signal high time >300ns to ensure that the device enters SHDN.

Test Circuits and Waveforms

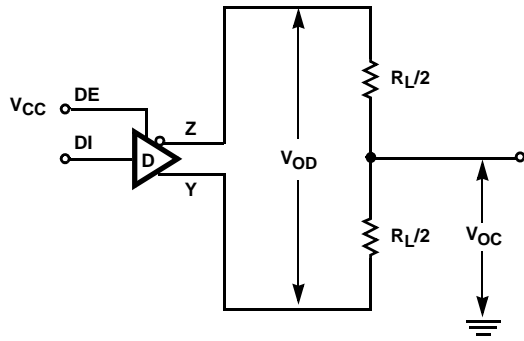

FIGURE 1A. V_{OD} AND V_{OC}

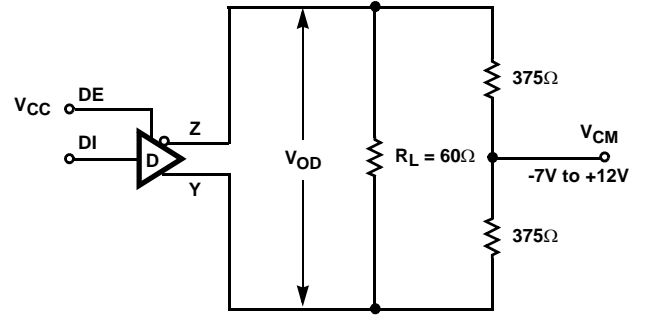

FIGURE 1B. V_{OD} WITH COMMON MODE LOAD

FIGURE 1. DC DRIVER TEST CIRCUITS

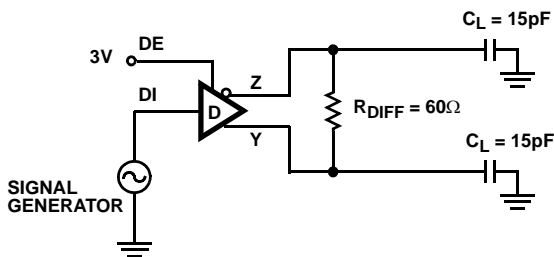

FIGURE 2A. DIFFERENTIAL TEST CIRCUIT

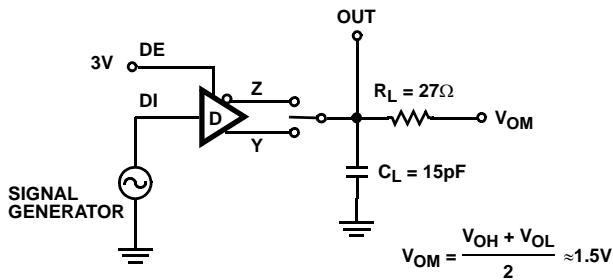

FIGURE 2C. SINGLE ENDED TEST CIRCUIT

$$V_{OM} = \frac{V_{OH} + V_{OL}}{2} \approx 1.5V$$

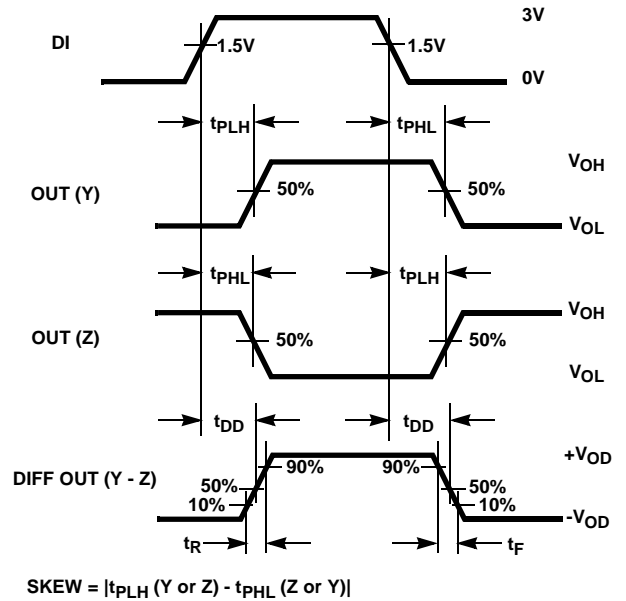
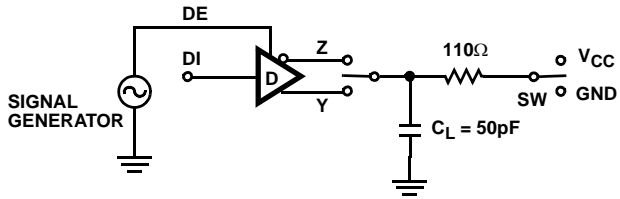

FIGURE 2B. MEASUREMENT POINTS

FIGURE 2. DRIVER PROPAGATION DELAY AND DIFFERENTIAL TRANSITION TIMES

Test Circuits and Waveforms (Continued)



PARAMETER	OUTPUT	\overline{RE}	DI	SW
t_{HZ}	Y/Z	X	1/0	GND
t_{LZ}	Y/Z	X	0/1	V_{CC}
t_{ZH}	Y/Z	0 (Note 5)	1/0	GND
t_{ZL}	Y/Z	0 (Note 5)	0/1	V_{CC}
$t_{ZH(SHDN)}$	Y/Z	1 (Note 8)	1/0	GND
$t_{ZL(SHDN)}$	Y/Z	1 (Note 8)	0/1	V_{CC}

FIGURE 3A. TEST CIRCUIT

FIGURE 3. DRIVER ENABLE AND DISABLE TIMES (EXCLUDING ISL83488, ISL83490)

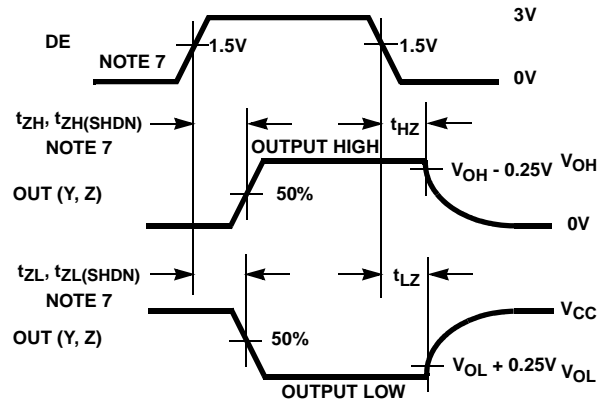

FIGURE 3B. MEASUREMENT POINTS

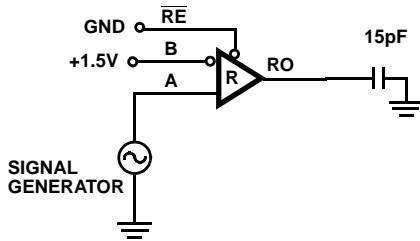

FIGURE 4A. TEST CIRCUIT

FIGURE 4. RECEIVER PROPAGATION DELAY

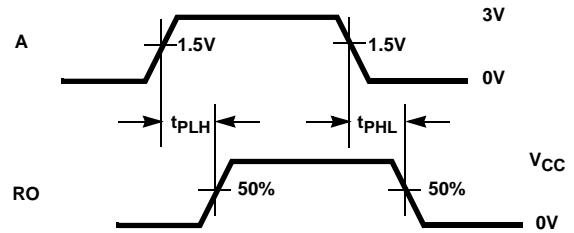
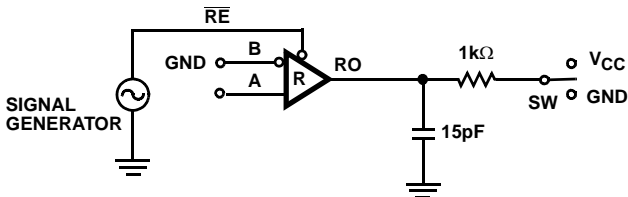

FIGURE 4B. MEASUREMENT POINTS



PARAMETER	DE	A	SW
t_{HZ}	0	+1.5V	GND
t_{LZ}	0	-1.5V	V_{CC}
t_{ZH} (Note 6)	0	+1.5V	GND
t_{ZL} (Note 6)	0	-1.5V	V_{CC}
$t_{ZH(SHDN)}$ (Note 9)	0	+1.5V	GND
$t_{ZL(SHDN)}$ (Note 9)	0	-1.5V	V_{CC}

FIGURE 5A. TEST CIRCUIT

FIGURE 5. RECEIVER ENABLE AND DISABLE TIMES (EXCLUDING ISL83488, ISL83490)

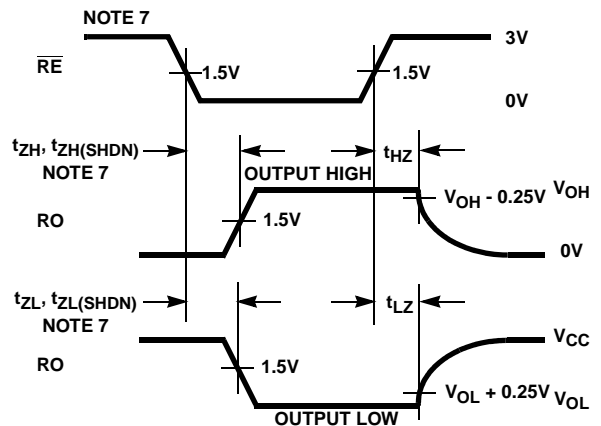

FIGURE 5B. MEASUREMENT POINTS

Application Information

RS-485 and RS-422 are differential (balanced) data transmission standards for use in long haul or noisy environments. RS-422 is a subset of RS-485, so RS-485 transceivers are also RS-422 compliant. RS-422 is a point-to-multipoint (multidrop) standard, which allows only one driver and up to 10 (assuming one unit load devices) receivers on each bus. RS-485 is a true multipoint standard, which allows up to 32 one unit load devices (any combination of drivers and receivers) on each bus. To allow for multipoint operation, the RS-485 spec requires that drivers must handle bus contention without sustaining any damage.

Another important advantage of RS-485 is the extended common mode range (CMR), which specifies that the driver outputs and receiver inputs withstand signals that range from +12V to -7V. RS-422 and RS-485 are intended for runs as long as 4000', so the wide CMR is necessary to handle ground potential differences, as well as voltages induced in the cable by external fields.

Receiver Features

These devices utilize a differential input receiver for maximum noise immunity and common mode rejection. Input sensitivity is $\pm 200\text{mV}$, as required by the RS422 and RS-485 specifications.

Receiver input impedance surpasses the RS-422 spec of $4\text{k}\Omega$, and meets the RS-485 "Unit Load" requirement of $12\text{k}\Omega$ minimum.

Receiver inputs function with common mode voltages as great as +9V/-7V outside the power supplies (i.e., +12V and -7V), making them ideal for long networks where induced voltages are a realistic concern.

All the receivers include a "fail-safe if open" function that guarantees a high level receiver output if the receiver inputs are unconnected (floating).

Receivers easily meet the data rates supported by the corresponding driver.

ISL83483, ISL83485, ISL83491 receiver outputs are tri-statable via the active low $\overline{\text{RE}}$ input.

Driver Features

The RS-485, RS-422 driver is a differential output device that delivers at least 1.5V across a 54Ω load (RS-485), and at least 2V across a 100Ω load (RS-422) even with $V_{\text{CC}} = 3\text{V}$. The drivers feature low propagation delay skew to maximize bit width, and to minimize EMI.

Drivers of the ISL83483, ISL83485, ISL83491 are tri-statable via the active high DE input.

ISL83483/88 driver outputs are slew rate limited to minimize EMI, and to minimize reflections in unterminated or improperly terminated networks. Data rate on these slew

rate limited versions is a maximum of 250kbps. Outputs of ISL83485, ISL83490, ISL83491 drivers are not limited, so faster output transition times allow data rates of at least 10Mbps.

Data Rate, Cables, and Terminations

RS-485, RS-422 are intended for network lengths up to 4000', but the maximum system data rate decreases as the transmission length increases. Devices operating at 10Mbps are limited to lengths of a few hundred feet, while the 250kbps versions can operate at full data rates with lengths in excess of 1000'.

Twisted pair is the cable of choice for RS-485, RS-422 networks. Twisted pair cables tend to pick up noise and other electromagnetically induced voltages as common mode signals, which are effectively rejected by the differential receivers in these ICs.

Proper termination is imperative, when using the 10Mbps devices, to minimize reflections. Short networks using the 250kbps versions need not be terminated, but, terminations are recommended unless power dissipation is an overriding concern.

In point-to-point, or point-to-multipoint (single driver on bus) networks, the main cable should be terminated in its characteristic impedance (typically 120Ω) at the end farthest from the driver. In multi-receiver applications, stubs connecting receivers to the main cable should be kept as short as possible. Multipoint (multi-driver) systems require that the main cable be terminated in its characteristic impedance at both ends. Stubs connecting a transceiver to the main cable should be kept as short as possible.

Built-In Driver Overload Protection

As stated previously, the RS-485 spec requires that drivers survive worst case bus contentions undamaged. The ISL834XX devices meet this requirement via driver output short circuit current limits, and on-chip thermal shutdown circuitry.

The driver output stages incorporate short circuit current limiting circuitry which ensures that the output current never exceeds the RS-485 spec, even at the common mode voltage range extremes. Additionally, these devices utilize a foldback circuit which reduces the short circuit current, and thus the power dissipation, whenever the contending voltage exceeds either supply.

In the event of a major short circuit condition, ISL834XX devices also include a thermal shutdown feature that disables the drivers whenever the die temperature becomes excessive. This eliminates the power dissipation, allowing the die to cool. The drivers automatically reenables after the die temperature drops about 15 degrees. If the contention persists, the thermal shutdown/reenable cycle repeats until the fault is cleared. Receivers stay operational during thermal shutdown.

Low Power Shutdown Mode (ISL83483, ISL83485, ISL83491 Only)

These CMOS transceivers all use a fraction of the power required by their bipolar counterparts, but the ISL83483, ISL83485, ISL83491 include a shutdown feature that reduces the already low quiescent I_{CC} to a 15nA trickle. They enter shutdown whenever the receiver and driver are **simultaneously** disabled ($\overline{RE} = V_{CC}$ and $DE = GND$) for a

period of at least 300ns. Disabling both the driver and the receiver for less than 80ns guarantees that shutdown is not entered.

Note that receiver and driver enable times increase when these devices enable from shutdown. Refer to Notes 5-9, at the end of the Electrical Specification table, for more information.

Typical Performance Curves $V_{CC} = 3.3V$, $T_A = 25^\circ C$, ISL83483 thru ISL83491; Unless Otherwise Specified

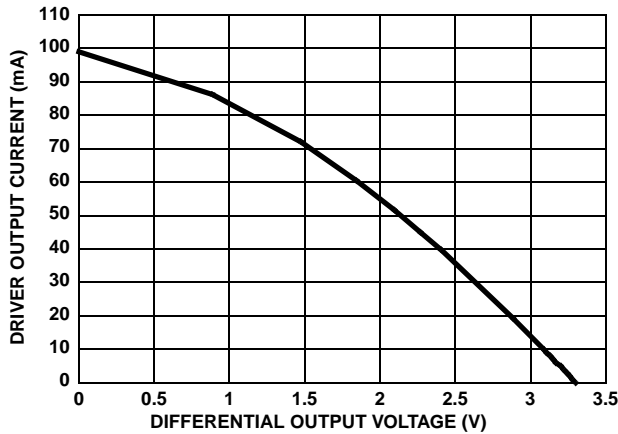

FIGURE 6. DRIVER OUTPUT CURRENT vs DIFFERENTIAL OUTPUT VOLTAGE

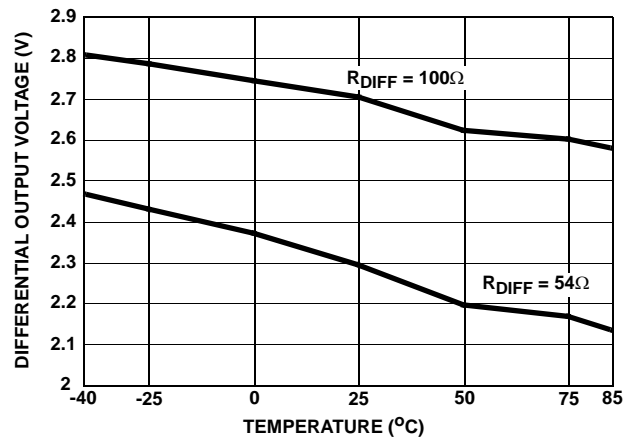

FIGURE 7. DRIVER DIFFERENTIAL OUTPUT VOLTAGE vs TEMPERATURE

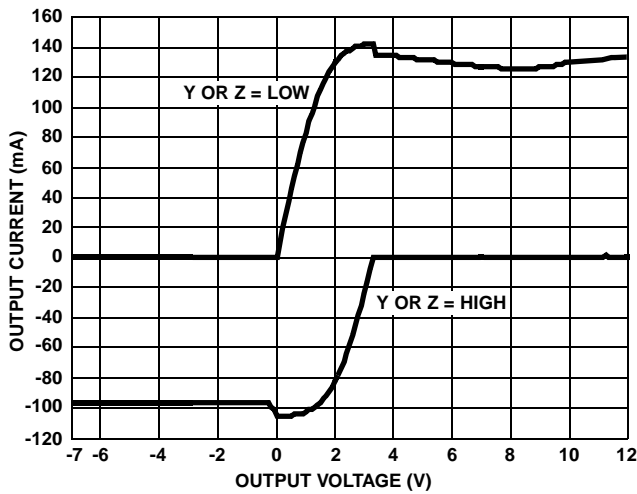

FIGURE 8. DRIVER OUTPUT CURRENT vs SHORT CIRCUIT VOLTAGE

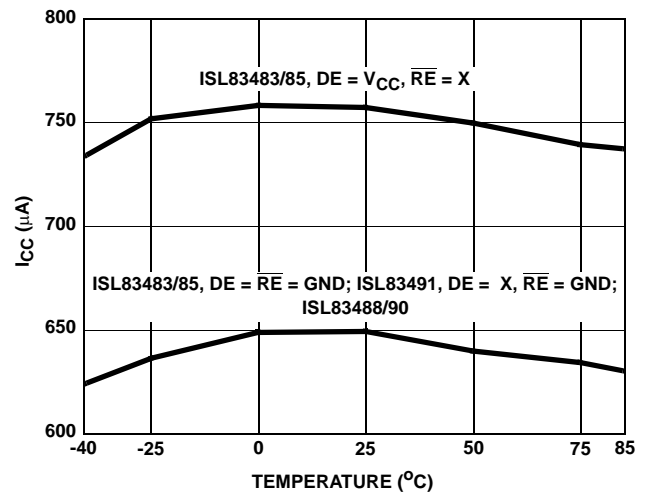

FIGURE 9. SUPPLY CURRENT vs TEMPERATURE

Typical Performance Curves $V_{CC} = 3.3V$, $T_A = 25^\circ C$, ISL83483 thru ISL83491; Unless Otherwise Specified (Continued)

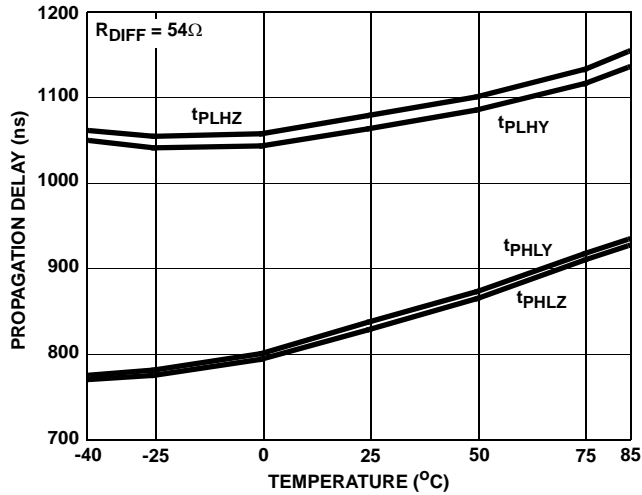

FIGURE 10. DRIVER PROPAGATION DELAY vs TEMPERATURE (ISL83483, ISL83488)

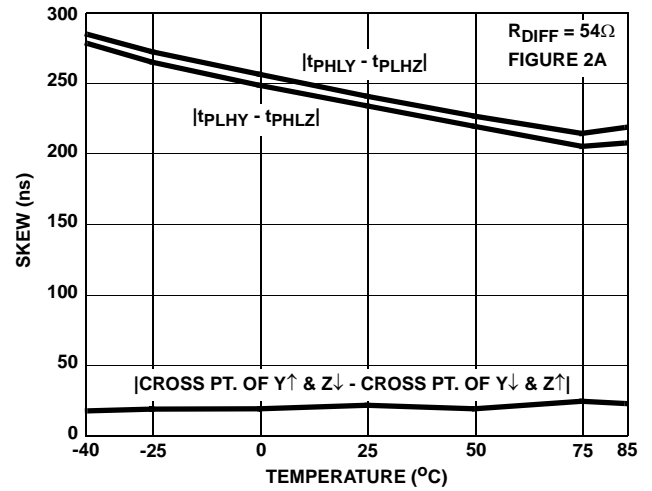

FIGURE 11. DRIVER SKEW vs TEMPERATURE (ISL83483, ISL83488)

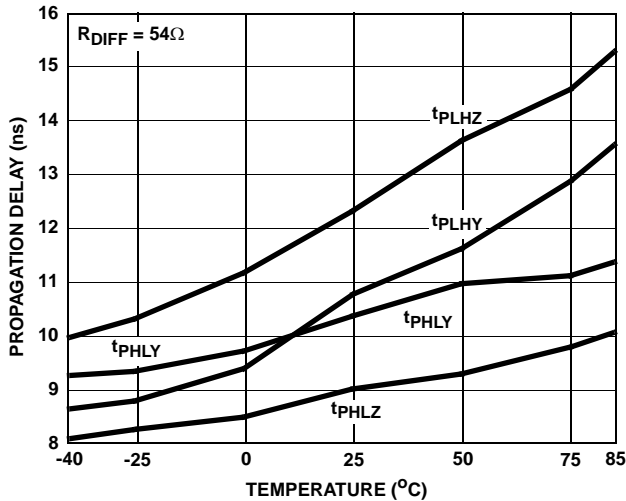

FIGURE 12. DRIVER PROPAGATION DELAY vs TEMPERATURE (ISL83485, ISL83490, ISL83491)

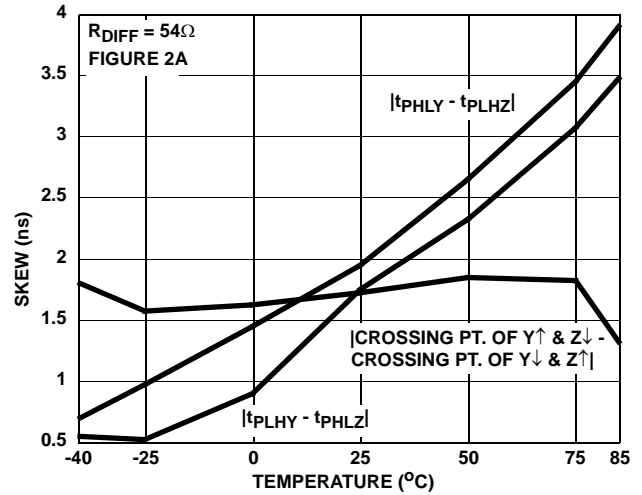

FIGURE 13. DRIVER SKEW vs TEMPERATURE (ISL83485, ISL83490, ISL83491)

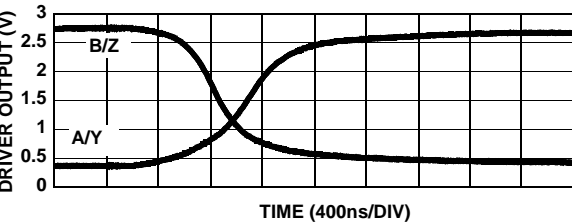
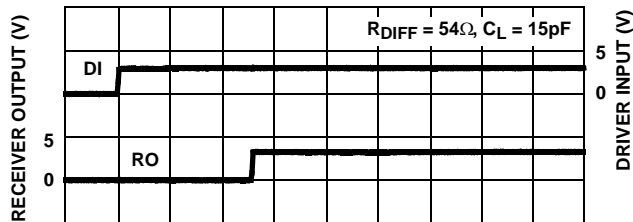

FIGURE 14. DRIVER AND RECEIVER WAVEFORMS, LOW TO HIGH (ISL83483, ISL83488)

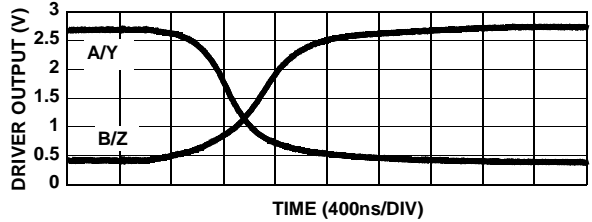
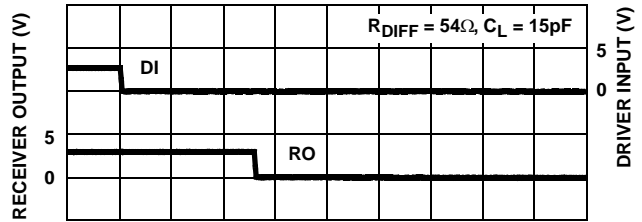

FIGURE 15. DRIVER AND RECEIVER WAVEFORMS, HIGH TO LOW (ISL83483, ISL83488)

Typical Performance Curves $V_{CC} = 3.3V$, $T_A = 25^\circ C$, ISL83483 thru ISL83491; Unless Otherwise Specified (Continued)

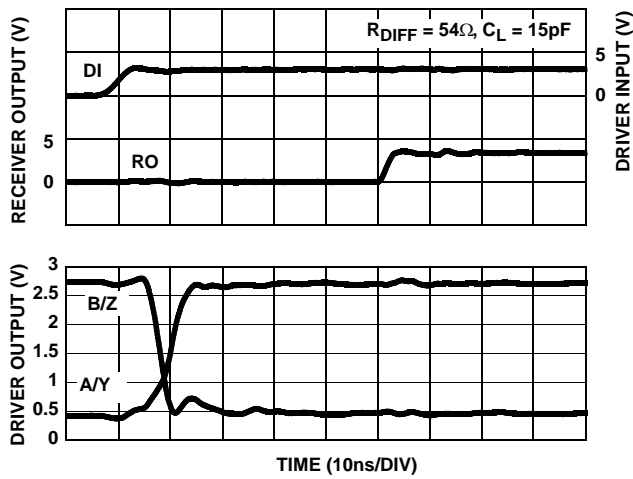

FIGURE 16. DRIVER AND RECEIVER WAVEFORMS, LOW TO HIGH (ISL83485, ISL83490, ISL83491)

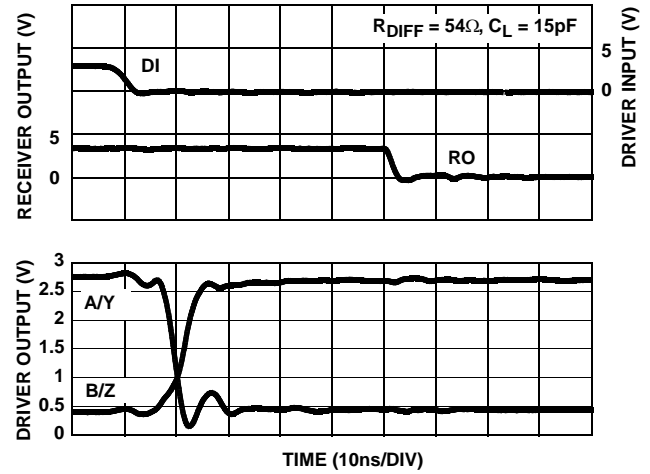

FIGURE 17. DRIVER AND RECEIVER WAVEFORMS, HIGH TO LOW (ISL83485, ISL83490, ISL83491)

Die Characteristics

SUBSTRATE POTENTIAL (POWERED UP):

GND

TRANSISTOR COUNT:

528

PROCESS:

Si Gate CMOS

Dual-In-Line Plastic Packages (PDIP)

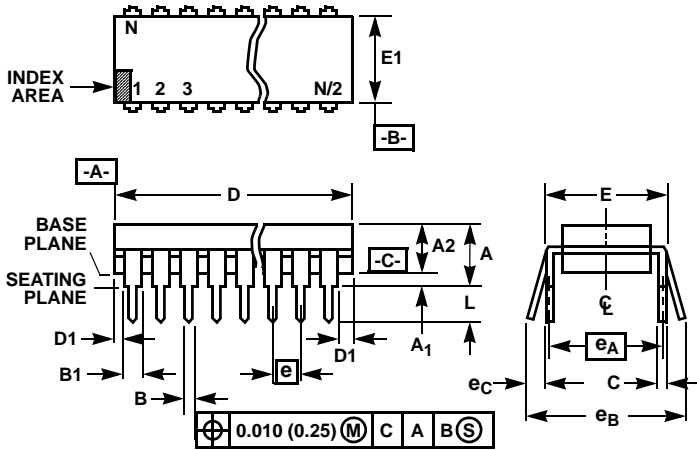

NOTES:

- Controlling Dimensions: INCH. In case of conflict between English and Metric dimensions, the inch dimensions control.
- Dimensioning and tolerancing per ANSI Y14.5M-1982.
- Symbols are defined in the "MO Series Symbol List" in Section 2.2 of Publication No. 95.
- Dimensions A, A1 and L are measured with the package seated in JEDEC seating plane gauge GS-3.
- D, D1, and E1 dimensions do not include mold flash or protrusions. Mold flash or protrusions shall not exceed 0.010 inch (0.25mm).
- E and e_A are measured with the leads constrained to be perpendicular to datum $-C-$.
- e_B and e_C are measured at the lead tips with the leads unconstrained. e_C must be zero or greater.
- B1 maximum dimensions do not include dambar protrusions. Dambar protrusions shall not exceed 0.010 inch (0.25mm).
- N is the maximum number of terminal positions.
- Corner leads (1, N, N/2 and N/2 + 1) for E8.3, E16.3, E18.3, E28.3, E42.6 will have a B1 dimension of 0.030 - 0.045 inch (0.76 - 1.14mm).

E8.3 (JEDEC MS-001-BA ISSUE D)
8 LEAD DUAL-IN-LINE PLASTIC PACKAGE

SYMBOL	INCHES		MILLIMETERS		NOTES
	MIN	MAX	MIN	MAX	
A	-	0.210	-	5.33	4
A1	0.015	-	0.39	-	4
A2	0.115	0.195	2.93	4.95	-
B	0.014	0.022	0.356	0.558	-
B1	0.045	0.070	1.15	1.77	8, 10
C	0.008	0.014	0.204	0.355	-
D	0.355	0.400	9.01	10.16	5
D1	0.005	-	0.13	-	5
E	0.300	0.325	7.62	8.25	6
E1	0.240	0.280	6.10	7.11	5
e	0.100 BSC		2.54 BSC		-
e_A	0.300 BSC		7.62 BSC		6
e_B	-	0.430	-	10.92	7
L	0.115	0.150	2.93	3.81	4
N	8		8		9

Rev. 0 12/93

Dual-In-Line Plastic Packages (PDIP)

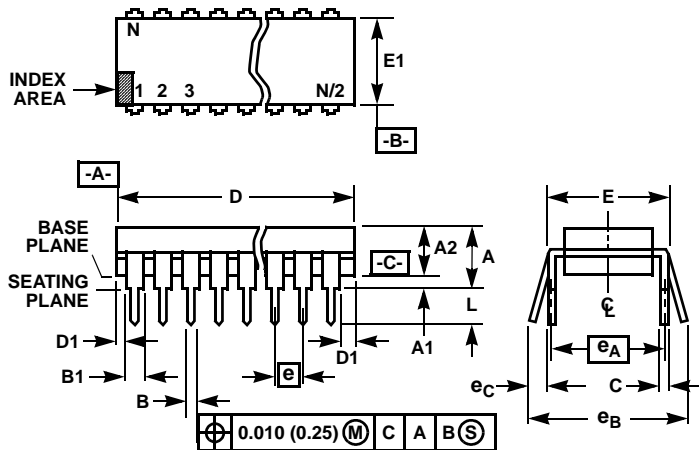

NOTES:

- Controlling Dimensions: INCH. In case of conflict between English and Metric dimensions, the inch dimensions control.
- Dimensioning and tolerancing per ANSI Y14.5M-1982.
- Symbols are defined in the "MO Series Symbol List" in Section 2.2 of Publication No. 95.
- Dimensions A, A1 and L are measured with the package seated in JEDEC seating plane gauge GS-3.
- D, D1, and E1 dimensions do not include mold flash or protrusions. Mold flash or protrusions shall not exceed 0.010 inch (0.25mm).
- E and e_A are measured with the leads constrained to be perpendicular to datum $-C-$.
- e_B and e_C are measured at the lead tips with the leads unconstrained. e_C must be zero or greater.
- B1 maximum dimensions do not include dambar protrusions. Dambar protrusions shall not exceed 0.010 inch (0.25mm).
- N is the maximum number of terminal positions.
- Corner leads (1, N, N/2 and N/2 + 1) for E8.3, E16.3, E18.3, E28.3, E42.6 will have a B1 dimension of 0.030 - 0.045 inch (0.76 - 1.14mm).

E14.3 (JEDEC MS-001-AA ISSUE D)
14 LEAD DUAL-IN-LINE PLASTIC PACKAGE

SYMBOL	INCHES		MILLIMETERS		NOTES
	MIN	MAX	MIN	MAX	
A	-	0.210	-	5.33	4
A1	0.015	-	0.39	-	4
A2	0.115	0.195	2.93	4.95	-
B	0.014	0.022	0.356	0.558	-
B1	0.045	0.070	1.15	1.77	8
C	0.008	0.014	0.204	0.355	-
D	0.735	0.775	18.66	19.68	5
D1	0.005	-	0.13	-	5
E	0.300	0.325	7.62	8.25	6
E1	0.240	0.280	6.10	7.11	5
e	0.100 BSC		2.54 BSC		-
e_A	0.300 BSC		7.62 BSC		6
e_B	-	0.430	-	10.92	7
L	0.115	0.150	2.93	3.81	4
N	14		14		9

Rev. 0 12/93

Small Outline Plastic Packages (SOIC)

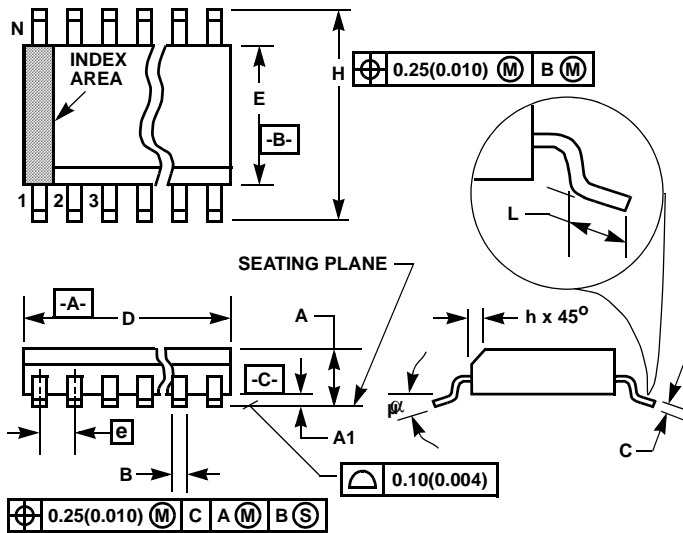

M8.15 (JEDEC MS-012-AA ISSUE C)
8 LEAD NARROW BODY SMALL OUTLINE PLASTIC PACKAGE

SYMBOL	INCHES		MILLIMETERS		NOTES
	MIN	MAX	MIN	MAX	
A	0.0532	0.0688	1.35	1.75	-
A1	0.0040	0.0098	0.10	0.25	-
B	0.013	0.020	0.33	0.51	9
C	0.0075	0.0098	0.19	0.25	-
D	0.1890	0.1968	4.80	5.00	3
E	0.1497	0.1574	3.80	4.00	4
e	0.050 BSC		1.27 BSC		-
H	0.2284	0.2440	5.80	6.20	-
h	0.0099	0.0196	0.25	0.50	5
L	0.016	0.050	0.40	1.27	6
N	8		8		7
α	0°	8°	0°	8°	-

NOTES:

1. Symbols are defined in the "MO Series Symbol List" in Section 2.2 of Publication Number 95.
2. Dimensioning and tolerancing per ANSI Y14.5M-1982.
3. Dimension "D" does not include mold flash, protrusions or gate burrs. Mold flash, protrusion and gate burrs shall not exceed 0.15mm (0.006 inch) per side.
4. Dimension "E" does not include interlead flash or protrusions. Interlead flash and protrusions shall not exceed 0.25mm (0.010 inch) per side.
5. The chamfer on the body is optional. If it is not present, a visual index feature must be located within the crosshatched area.
6. "L" is the length of terminal for soldering to a substrate.
7. "N" is the number of terminal positions.
8. Terminal numbers are shown for reference only.
9. The lead width "B", as measured 0.36mm (0.014 inch) or greater above the seating plane, shall not exceed a maximum value of 0.61mm (0.024 inch).
10. Controlling dimension: MILLIMETER. Converted inch dimensions are not necessarily exact.

Rev. 0 12/93

Small Outline Plastic Packages (SOIC)

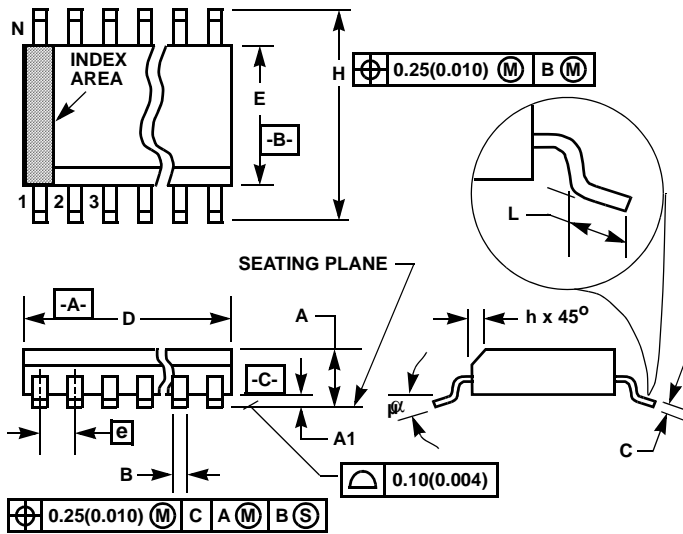

**M14.15 (JEDEC MS-012-AB ISSUE C)
14 LEAD NARROW BODY SMALL OUTLINE PLASTIC
PACKAGE**

SYMBOL	INCHES		MILLIMETERS		NOTES
	MIN	MAX	MIN	MAX	
A	0.0532	0.0688	1.35	1.75	-
A1	0.0040	0.0098	0.10	0.25	-
B	0.013	0.020	0.33	0.51	9
C	0.0075	0.0098	0.19	0.25	-
D	0.3367	0.3444	8.55	8.75	3
E	0.1497	0.1574	3.80	4.00	4
e	0.050 BSC		1.27 BSC		-
H	0.2284	0.2440	5.80	6.20	-
h	0.0099	0.0196	0.25	0.50	5
L	0.016	0.050	0.40	1.27	6
N	14		14		7
α	0°	8°	0°	8°	-

NOTES:

1. Symbols are defined in the "MO Series Symbol List" in Section 2.2 of Publication Number 95.
2. Dimensioning and tolerancing per ANSI Y14.5M-1982.
3. Dimension "D" does not include mold flash, protrusions or gate burrs. Mold flash, protrusion and gate burrs shall not exceed 0.15mm (0.006 inch) per side.
4. Dimension "E" does not include interlead flash or protrusions. Interlead flash and protrusions shall not exceed 0.25mm (0.010 inch) per side.
5. The chamfer on the body is optional. If it is not present, a visual index feature must be located within the crosshatched area.
6. "L" is the length of terminal for soldering to a substrate.
7. "N" is the number of terminal positions.
8. Terminal numbers are shown for reference only.
9. The lead width "B", as measured 0.36mm (0.014 inch) or greater above the seating plane, shall not exceed a maximum value of 0.61mm (0.024 inch).
10. Controlling dimension: MILLIMETER. Converted inch dimensions are not necessarily exact.

Rev. 0 12/93

All Intersil U.S. products are manufactured, assembled and tested utilizing ISO9000 quality systems. Intersil Corporation's quality certifications can be viewed at www.intersil.com/design/quality

Intersil products are sold by description only. Intersil Corporation reserves the right to make changes in circuit design, software and/or specifications at any time without notice. Accordingly, the reader is cautioned to verify that data sheets are current before placing orders. Information furnished by Intersil is believed to be accurate and reliable. However, no responsibility is assumed by Intersil or its subsidiaries for its use; nor for any infringements of patents or other rights of third parties which may result from its use. No license is granted by implication or otherwise under any patent or patent rights of Intersil or its subsidiaries.

For information regarding Intersil Corporation and its products, see www.intersil.com