

**Data sheet | Item number: 2200-1201**

2-conductor through terminal block; with push-button; 1 mm<sup>2</sup>; with test port; side and center marking; for DIN-rail 35 x 15 and 35 x 7.5; Push-in CAGE CLAMP®; 1,00 mm<sup>2</sup>; gray

[www.wago.com/2200-1201](http://www.wago.com/2200-1201)

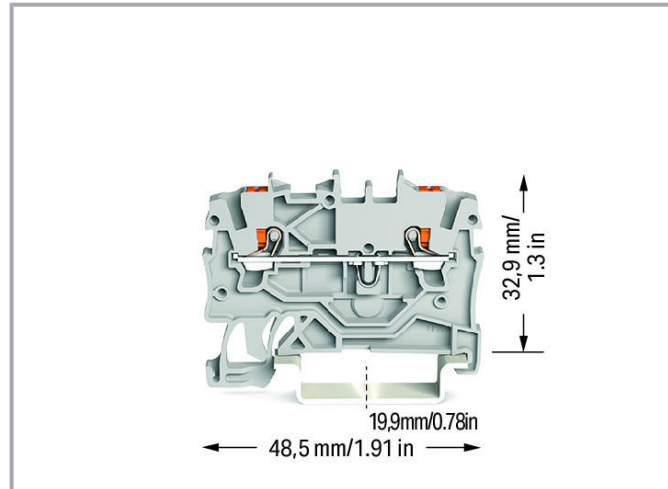
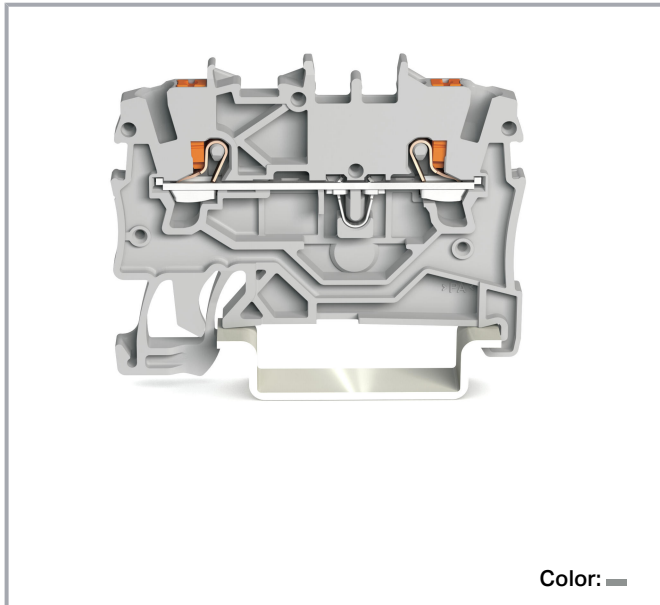

Subject to changes. Please also observe the further product documentation!

WAGO GmbH & Co. KG  
Hansastr. 27  
32423 Minden  
Phone: +49571 887-0 | Fax: +49571 887-169  
Email: [info.de@wago.com](mailto:info.de@wago.com) | Web: [www.wago.com](http://www.wago.com)

Do you have any questions about our products?  
We are always happy to take your call at +49 (571) 887-44222.



## Data

### Electrical data

#### Ratings per IEC/EN

Ratings per	IEC/EN 60947-7-1
Nominal voltage (III/3)	800 V
Rated surge voltage (III/3)	8 kV
Rated current	13.5 A
Rated current 2	17.5 A
Legend (ratings)	(III / 3) ≙ Overvoltage category III / Pollution degree 3

Subject to changes. Please also observe the further product documentation!

WAGO GmbH & Co. KG  
Hansastr. 27  
32423 Minden  
Phone: +49571 887-0 | Fax: +49571 887-169  
Email: [info.de@wago.com](mailto:info.de@wago.com) | Web: [www.wago.com](http://www.wago.com)

Do you have any questions about our products?  
We are always happy to take your call at +49 (571) 887-44222.



## Ratings per UL

Approvals per	UL 1059
Rated voltage UL (Use Group B)	600 V
Rated current UL (Use Group B)	10 A
Rated voltage UL (Use Group C)	600 V
Rated current UL (Use Group C)	10 A

## Ratings per CSA

Approvals per	C22.2 No 158
Rated voltage CSA (Use Group B)	600 V
Rated current CSA (Use Group B)	10 A
Rated voltage CSA (Use Group C)	600 V
Rated current CSA (Use Group C)	10 A

## Ex information

Ratings per	ATEX: PTB 18 ATEX 1004 U / IECEx: PTB 18.0010U (Ex eb IIC Gb)
Rated voltage EN (Ex e II)	550 V
Rated current (Ex e II)	13 A
Rated current (Ex e II) with jumper	12 A
Ratings (note)	See Downloads – Documentation – Additional Information: Technical explanations

## Connection data

Total number of connection points	2
Total number of potentials	1
Number of levels	1
Number of jumper slots	2

## Connection 1

Connection technology	Push-in CAGE CLAMP®
Actuation type	Push-in Push-button Operating tool
Connectable conductor materials	Copper
Nominal cross-section	1 mm <sup>2</sup>
Solid conductor	0.14 ... 1.5 mm <sup>2</sup> / 24 ... 16 AWG

Subject to changes. Please also observe the further product documentation!



Solid conductor; push-in termination	0.5 ... 1.5 mm <sup>2</sup> / 20 ... 16 AWG
Fine-stranded conductor	0.14 ... 1.5 mm <sup>2</sup> / 24 ... 16 AWG
Fine-stranded conductor; with insulated ferrule	0.14 ... 0.75 mm <sup>2</sup> / 24 ... 18 AWG
Fine-stranded conductor; with ferrule; push-in termination	0.5 ... 0.75 mm <sup>2</sup> / 20 ... 18 AWG
Note (conductor cross-section)	Depending on the conductor characteristic, a conductor with a smaller cross-section can also be inserted via push-in termination.
Strip length	9 ... 11 mm / 0.35 ... 0.43 inch
Wiring direction	Front-entry wiring

### Physical data

Width	3.5 mm / 0.138 inch
Height	48.5 mm / 1.909 inch
Depth from upper edge of DIN-rail	32.9 mm / 1.295 inch

### Mechanical data

Design	horizontal type
Mounting type	DIN-35 rail
Marking level	Center/side marking

### Material data

Note on material data	Information on material data can be found here
Color	gray
Insulation material	Polyamide (PA66)
Flammability class per UL94	V0
Fire load	0.075 MJ
Weight	3.5 g

### Commercial data

PU (SPU)	100 Stück
Packaging type	box
Country of origin	DE
GTIN	4055143691543
Customs tariff number	85369010000

### Approvals / Certificates

#### Ex-Approvals

Logo	Approval	Additional Approval Text	Certificate name
------	----------	--------------------------	------------------



Subject to changes. Please also observe the further product documentation!

WAGO GmbH & Co. KG  
 Hansastr. 27  
 32423 Minden  
 Phone: +49571 887-0 | Fax: +49571 887-169  
 Email: [info.de@wago.com](mailto:info.de@wago.com) | Web: [www.wago.com](http://www.wago.com)

Do you have any questions about our products?  
 We are always happy to take your call at +49 (571) 887-44222.

	AEx Underwriters Laboratories Inc.	UL 60079	E185892 (AEx eb IIC resp. Ex eb IIC)
	ATEX Physikalisch Technische Bundesanstalt	IEC 60079-0	PTB 18 ATEX 1003 U (II 2 G Ex eb II C Gb bzw. I M 2 Ex eb I Mb)
	CCCEX CQST/CNEx	CNCA-C23-01	202031231000166
	EAC Brjansker Zertifizierungsstelle	TP TC 012/2011	RU C-DE.AM02.B. 00127/19 (Ex e IIC Gb U)
	IECEX Physikalisch Technische Bundesanstalt	IEC 60079	IECEX PTB 18.0010 U (Ex eb IIC Gb and Ex eb I Mb)

## Country specific Approvals

Logo	Approval	Additional Approval Text	Certificate name
	CCA DEKRA Certification B.V.	EN 60947	NTR NL 7663
	CSA DEKRA Certification B.V.	C22.2	70173737
	KEMA/KEUR DEKRA Certification B.V.	IEC 60947	71- 102874

## Ship Approvals

Logo	Approval	Additional Approval Text	Certificate name
	ABS American Bureau of Shipping	-	19- HG1866350- PDA

Subject to changes. Please also observe the further product documentation!



**BV**  
Bureau Veritas S.A.

IEC 60947

58186/A0  
BV

**DNV GL**  
Det Norske Veritas, Germanischer Lloyd

-

TAE00003JT



**LR**  
Lloyds Register

-

19/20050

### UL-Approvals

Logo	Approval	Additional Approval Text	Certificate name
	<b>cURus</b> Underwriters Laboratories Inc.	UL 1059	E45172



### Required accessories

#### End plate

End plate		
Item no.: 2000-1291 End and intermediate plate; 0.7 mm thick; gray		<a href="http://www.wago.com/2000-1291">www.wago.com/2000-1291</a>
Item no.: 2000-1292 End and intermediate plate; 0.7 mm thick; orange		<a href="http://www.wago.com/2000-1292">www.wago.com/2000-1292</a>

### Optional accessories

#### Push-in type wire jumper

Jumper		
 Item no.: 2009-404 Push-in type wire jumper; 0.75 mm <sup>2</sup> ; insulated; 110 mm long; gray		<a href="http://www.wago.com/2009-404">www.wago.com/2009-404</a>
 Item no.: 2009-402 Push-in type wire jumper; 0.75 mm <sup>2</sup> ; insulated; 60 mm long; gray		<a href="http://www.wago.com/2009-402">www.wago.com/2009-402</a>
 Item no.: 2009-406 Push-in type wire jumper; 0.75 mm <sup>2</sup> ; insulated; 250 mm long; gray		<a href="http://www.wago.com/2009-406">www.wago.com/2009-406</a>

















### Testing and measuring

#### Testing accessories





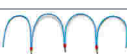





Subject to changes. Please also observe the further product documentation!

WAGO GmbH & Co. KG  
Hansastr. 27  
32423 Minden  
Phone: +49571 887-0 | Fax: +49571 887-169  
Email: [info.de@wago.com](mailto:info.de@wago.com) | Web: [www.wago.com](http://www.wago.com)

Do you have any questions about our products?  
We are always happy to take your call at +49 (571) 887-44222.

	<b>Item no.: 2009-174</b> Test plug adapter; for 4 mm Ø test plugs; for testing TOPJOB®S rail-mounted terminal blocks; gray	<a href="http://www.wago.com/2009-174">www.wago.com/2009-174</a>
	<b>Item no.: 2009-182</b> Testing tap; for max. 2.5 mm <sup>2</sup> ; tool-free connection for individual test wires 0.08 - 2.5 mm; gray	<a href="http://www.wago.com/2009-182">www.wago.com/2009-182</a>
	<b>Item no.: 2000-510</b> TOPJOB®S L-type test plug module; modular; for jumper contact slot; 1,00 mm <sup>2</sup> ; gray	<a href="http://www.wago.com/2000-510">www.wago.com/2000-510</a>
	<b>Item no.: 2000-511</b> TOPJOB®S L-type test plug module; modular; for jumper contact slot; 1-pole; 1,00 mm <sup>2</sup> ; gray	<a href="http://www.wago.com/2000-511">www.wago.com/2000-511</a>
	<b>Item no.: 2000-549</b> Spacer module; modular; e.g., for bridging commoned terminal blocks; gray	<a href="http://www.wago.com/2000-549">www.wago.com/2000-549</a>
	<b>Item no.: 2000-555</b> Modular TOPJOB®S connector; modular; for jumper contact slot; 5-pole; 1,00 mm <sup>2</sup> ; gray	<a href="http://www.wago.com/2000-555">www.wago.com/2000-555</a>
	<b>Item no.: 2000-553</b> Modular TOPJOB®S connector; modular; for jumper contact slot; 3-pole; 1,00 mm <sup>2</sup> ; gray	<a href="http://www.wago.com/2000-553">www.wago.com/2000-553</a>
	<b>Item no.: 2000-556</b> Modular TOPJOB®S connector; modular; for jumper contact slot; 6-pole; 1,00 mm <sup>2</sup> ; gray	<a href="http://www.wago.com/2000-556">www.wago.com/2000-556</a>
	<b>Item no.: 2000-558</b> Modular TOPJOB®S connector; modular; for jumper contact slot; 8-pole; 1,00 mm <sup>2</sup> ; gray	<a href="http://www.wago.com/2000-558">www.wago.com/2000-558</a>
	<b>Item no.: 2000-559</b> Modular TOPJOB®S connector; modular; for jumper contact slot; 9-pole; 1,00 mm <sup>2</sup> ; gray	<a href="http://www.wago.com/2000-559">www.wago.com/2000-559</a>
	<b>Item no.: 2000-552</b> Modular TOPJOB®S connector; modular; for jumper contact slot; 2-pole; 1,00 mm <sup>2</sup> ; gray	<a href="http://www.wago.com/2000-552">www.wago.com/2000-552</a>
	<b>Item no.: 2000-560</b> Modular TOPJOB®S connector; modular; for jumper contact slot; 10-pole; 1,00 mm <sup>2</sup> ; gray	<a href="http://www.wago.com/2000-560">www.wago.com/2000-560</a>
	<b>Item no.: 2000-554</b> Modular TOPJOB®S connector; modular; for jumper contact slot; 4-pole; 1,00 mm <sup>2</sup> ; gray	<a href="http://www.wago.com/2000-554">www.wago.com/2000-554</a>
	<b>Item no.: 2000-557</b> Modular TOPJOB®S connector; modular; for jumper contact slot; 7-pole; 1,00 mm <sup>2</sup> ; gray	<a href="http://www.wago.com/2000-557">www.wago.com/2000-557</a>
	<b>Item no.: 210-136</b> Test plug; 2 mm Ø; with 500 mm cable; red	<a href="http://www.wago.com/210-136">www.wago.com/210-136</a>
<b>Jumpers</b>		
Jumper		
	<b>Item no.: 210-123</b> Wire commoning chain; insulated; blue	<a href="http://www.wago.com/210-123">www.wago.com/210-123</a>
	<b>Item no.: 2000-408</b>	

Subject to changes. Please also observe the further product documentation!

	Jumper; 8-way; insulated; light gray	<a href="http://www.wago.com/2000-408">www.wago.com/2000-408</a>
	<b>Item no.: 2000-407</b> Jumper; 7-way; insulated; light gray	<a href="http://www.wago.com/2000-407">www.wago.com/2000-407</a>
	<b>Item no.: 2000-409</b> Jumper; 9-way; insulated; light gray	<a href="http://www.wago.com/2000-409">www.wago.com/2000-409</a>
	<b>Item no.: 2000-408/000-006</b> Jumper; 8-way; insulated; blue	<a href="http://www.wago.com/2000-408/000-006">www.wago.com/2000-408/000-006</a>
	<b>Item no.: 2000-408/000-005</b> Jumper; 8-way; insulated; red	<a href="http://www.wago.com/2000-408/000-005">www.wago.com/2000-408/000-005</a>
	<b>Item no.: 2000-409/000-005</b> Jumper; 9-way; insulated; red	<a href="http://www.wago.com/2000-409/000-005">www.wago.com/2000-409/000-005</a>
	<b>Item no.: 2000-407/000-006</b> Jumper; 7-way; insulated; blue	<a href="http://www.wago.com/2000-407/000-006">www.wago.com/2000-407/000-006</a>
	<b>Item no.: 2000-410</b> Jumper; 10-way; insulated; light gray	<a href="http://www.wago.com/2000-410">www.wago.com/2000-410</a>
	<b>Item no.: 2000-410/000-006</b> Jumper; 10-way; insulated; blue	<a href="http://www.wago.com/2000-410/000-006">www.wago.com/2000-410/000-006</a>
	<b>Item no.: 2000-433/000-005</b> Jumper; from 1 to 3; insulated; red	<a href="http://www.wago.com/2000-433/000-005">www.wago.com/2000-433/000-005</a>
	<b>Item no.: 2000-407/000-005</b> Jumper; 7-way; insulated; red	<a href="http://www.wago.com/2000-407/000-005">www.wago.com/2000-407/000-005</a>
	<b>Item no.: 2000-433/000-006</b> Jumper; from 1 to 3; insulated; blue	<a href="http://www.wago.com/2000-433/000-006">www.wago.com/2000-433/000-006</a>
	<b>Item no.: 2000-410/000-005</b> Jumper; 10-way; insulated; red	<a href="http://www.wago.com/2000-410/000-005">www.wago.com/2000-410/000-005</a>
	<b>Item no.: 2000-435</b> Jumper; from 1 to 5; insulated; light gray	<a href="http://www.wago.com/2000-435">www.wago.com/2000-435</a>

Subject to changes. Please also observe the further product documentation!





**Item no.: 2000-409/000-006**  
Jumper; 9-way; insulated; blue

[www.wago.com/2000-409/000-006](http://www.wago.com/2000-409/000-006)



**Item no.: 2000-436**  
Jumper; from 1 to 6; insulated; light gray

[www.wago.com/2000-436](http://www.wago.com/2000-436)



**Item no.: 2000-433**  
Jumper; from 1 to 3; insulated; light gray

[www.wago.com/2000-433](http://www.wago.com/2000-433)



**Item no.: 2000-434**  
Jumper; from 1 to 4; insulated; light gray

[www.wago.com/2000-434](http://www.wago.com/2000-434)



**Item no.: 2000-402**  
Jumper; 2-way; insulated; light gray

[www.wago.com/2000-402](http://www.wago.com/2000-402)



**Item no.: 2000-402/000-006**  
Jumper; 2-way; insulated; blue

[www.wago.com/2000-402/000-006](http://www.wago.com/2000-402/000-006)



**Item no.: 2000-403**  
Jumper; 3-way; insulated; light gray

[www.wago.com/2000-403](http://www.wago.com/2000-403)



**Item no.: 2000-402/000-005**  
Jumper; 2-way; insulated; red

[www.wago.com/2000-402/000-005](http://www.wago.com/2000-402/000-005)



**Item no.: 2000-402/000-018**  
Jumper; 2-way; insulated; yellow-green

[www.wago.com/2000-402/000-018](http://www.wago.com/2000-402/000-018)



**Item no.: 2000-404**  
Jumper; 4-way; insulated; light gray

[www.wago.com/2000-404](http://www.wago.com/2000-404)



**Item no.: 2000-403/000-005**  
Jumper; 3-way; insulated; red

[www.wago.com/2000-403/000-005](http://www.wago.com/2000-403/000-005)



**Item no.: 2000-404/000-006**  
Jumper; 4-way; insulated; blue

[www.wago.com/2000-404/000-006](http://www.wago.com/2000-404/000-006)



**Item no.: 2000-403/000-006**  
Jumper; 3-way; insulated; blue

[www.wago.com/2000-403/000-006](http://www.wago.com/2000-403/000-006)



**Item no.: 2000-404/000-005**  
Jumper; 4-way; insulated; red













[www.wago.com/2000-404/000-005](http://www.wago.com/2000-404/000-005)



**Item no.: 2000-405**  
Jumper; 5-way; insulated; light gray

[www.wago.com/2000-405](http://www.wago.com/2000-405)

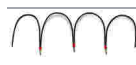
Subject to changes. Please also observe the further product documentation!

	<p><b>Item no.: 2000-405/011-000</b> Star point jumper; 3-way; insulated; light gray</p>	<a href="http://www.wago.com/2000-405/011-000">www.wago.com/2000-405/011-000</a>
	<p><b>Item no.: 2000-405/000-006</b> Jumper; 5-way; insulated; blue</p>	<a href="http://www.wago.com/2000-405/000-006">www.wago.com/2000-405/000-006</a>
	<p><b>Item no.: 2000-406/000-006</b> Jumper; 6-way; insulated; blue</p>	<a href="http://www.wago.com/2000-406/000-006">www.wago.com/2000-406/000-006</a>
	<p><b>Item no.: 2000-405/000-005</b> Jumper; 5-way; insulated; red</p>	<a href="http://www.wago.com/2000-405/000-005">www.wago.com/2000-405/000-005</a>
	<p><b>Item no.: 2000-406</b> Jumper; 6-way; insulated; light gray</p>	<a href="http://www.wago.com/2000-406">www.wago.com/2000-406</a>
	<p><b>Item no.: 2000-406/000-005</b> Jumper; 6-way; insulated; red</p>	<a href="http://www.wago.com/2000-406/000-005">www.wago.com/2000-406/000-005</a>
	<p><b>Item no.: 2000-406/020-000</b> Delta jumper; insulated; light gray</p>	<a href="http://www.wago.com/2000-406/020-000">www.wago.com/2000-406/020-000</a>
	<p><b>Item no.: 2000-437</b> Jumper; from 1 to 7; insulated; light gray</p>	<a href="http://www.wago.com/2000-437">www.wago.com/2000-437</a>
	<p><b>Item no.: 2000-438</b> Jumper; from 1 to 8; insulated; light gray</p>	<a href="http://www.wago.com/2000-438">www.wago.com/2000-438</a>
	<p><b>Item no.: 2000-439</b> Jumper; from 1 to 9; insulated; light gray</p>	<a href="http://www.wago.com/2000-439">www.wago.com/2000-439</a>
	<p><b>Item no.: 2000-440</b> Jumper; from 1 to 10; insulated; light gray</p>	<a href="http://www.wago.com/2000-440">www.wago.com/2000-440</a>
	<p><b>Item no.: 210-103</b> Wire commoning chain; insulated; black</p>	<a href="http://www.wago.com/210-103">www.wago.com/210-103</a>
<b>Tool</b>		
Operating tool		
	<p><b>Item no.: 210-648</b> Operating tool; Blade: 2.5 x 0.4 mm; with a partially insulated shaft; angled; short</p>	<a href="http://www.wago.com/210-648">www.wago.com/210-648</a>
	<p><b>Item no.: 210-647</b> Operating tool; Blade: 2.5 x 0.4 mm; with a partially insulated shaft; multicoloured</p>	<a href="http://www.wago.com/210-647">www.wago.com/210-647</a>
	<p><b>Item no.: 210-719</b> Operating tool; Blade: 2.5 x 0.4 mm; with a partially insulated shaft</p>	<a href="http://www.wago.com/210-719">www.wago.com/210-719</a>

Subject to changes. Please also observe the further product documentation!

## Mounting

### Mounting accessories

**Item no.: 709-156**

Cover; Type 3; suitable for cover carrier, type 3; 1 m long; transparent

[www.wago.com/709-156](http://www.wago.com/709-156)

**Item no.: 709-169**

Cover carrier; Type 3; gray

[www.wago.com/709-169](http://www.wago.com/709-169)

## Ferrule

### Ferrule

**Item no.: 216-241**

 Ferrule; Sleeve for 0.5 mm<sup>2</sup> / 20 AWG; insulated; electro-tin plated; electrolytic copper; gastight crimped; acc. to DIN 46228, Part 4/09.90; white

[www.wago.com/216-241](http://www.wago.com/216-241)

**Item no.: 216-242**

 Ferrule; Sleeve for 0.75 mm<sup>2</sup> / 18 AWG; insulated; electro-tin plated; electrolytic copper; gastight crimped; acc. to DIN 46228, Part 4/09.90; gray

[www.wago.com/216-242](http://www.wago.com/216-242)

**Item no.: 216-243**

 Ferrule; Sleeve for 1 mm<sup>2</sup> / AWG 18; insulated; electro-tin plated; electrolytic copper; gastight crimped; acc. to DIN 46228, Part 4/09.90; red

[www.wago.com/216-243](http://www.wago.com/216-243)

## Carrier rail

### Mounting accessories



**Item no.: 210-197**

Steel carrier rail; 35 x 15 mm; 1.5 mm thick; 2 m long; slotted; similar to EN 60715; silver-colored

[www.wago.com/210-197](http://www.wago.com/210-197)

**Item no.: 210-198**

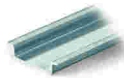
Copper carrier rail; 35 x 15 mm; 2.3 mm thick; 2 m long; unslotted; according to EN 60715; copper-colored

[www.wago.com/210-198](http://www.wago.com/210-198)

**Item no.: 210-113**

Steel carrier rail; 35 x 7.5 mm; 1 mm thick; 2 m long; unslotted; according to EN 60715; silver-colored

[www.wago.com/210-113](http://www.wago.com/210-113)

**Item no.: 210-118**

Steel carrier rail; 35 x 15 mm; 2.3 mm thick; 2 m long; unslotted; according to EN 60715; silver-colored

[www.wago.com/210-118](http://www.wago.com/210-118)

**Item no.: 210-112**

Steel carrier rail; 35 x 7.5 mm; 1 mm thick; 2 m long; slotted; according to EN 60715; "Hole width 25 mm; silver-colored

[www.wago.com/210-112](http://www.wago.com/210-112)

**Item no.: 210-114**

Steel carrier rail; 35 x 15 mm; 1.5 mm thick; 2 m long; unslotted; similar to EN 60715; silver-colored

[www.wago.com/210-114](http://www.wago.com/210-114)

**Item no.: 210-115**

Steel carrier rail; 35 x 7.5 mm; 1 mm thick; 2 m long; slotted; according to EN 60715; "Hole width 18 mm; silver-colored

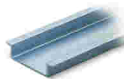
[www.wago.com/210-115](http://www.wago.com/210-115)

**Item no.: 210-196**

Aluminum carrier rail; 35 x 8.2 mm; 1.6 mm thick; 2 m long; unslotted; similar to EN 60715; silver-colored

[www.wago.com/210-196](http://www.wago.com/210-196)

Subject to changes. Please also observe the further product documentation!

WAGO GmbH &amp; Co. KG

Hansastr. 27

32423 Minden

Phone: +49571 887-0 | Fax: +49571 887-169

 Email: [info.de@wago.com](mailto:info.de@wago.com) | Web: [www.wago.com](http://www.wago.com)

Do you have any questions about our products?

We are always happy to take your call at +49 (571) 887-44222.

Marking accessories

Marking strip



**Item no.: 2009-110**

Marking strips; for Smart Printer; on reel; not stretchable; plain; snap-on type; white

[www.wago.com/2009-110](http://www.wago.com/2009-110)

Marker



**Item no.: 2009-113**

WMB-Inline; for Smart Printer; 2300 pieces on roll; plain; snap-on type; white

[www.wago.com/2009-113](http://www.wago.com/2009-113)



**Item no.: 2009-113/000-002**

WMB-Inline; for Smart Printer; 2300 pieces on roll; plain; snap-on type; yellow

[www.wago.com/2009-113/000-002](http://www.wago.com/2009-113/000-002)



**Item no.: 2009-113/000-012**

WMB-Inline; for Smart Printer; 2300 pieces on roll; plain; snap-on type; orange

[www.wago.com/2009-113/000-012](http://www.wago.com/2009-113/000-012)



**Item no.: 2009-113/000-007**

WMB-Inline; for Smart Printer; 2300 pieces on roll; plain; snap-on type; gray

[www.wago.com/2009-113/000-007](http://www.wago.com/2009-113/000-007)



**Item no.: 2009-113/000-005**

WMB-Inline; for Smart Printer; 2300 pieces on roll; plain; snap-on type; red

[www.wago.com/2009-113/000-005](http://www.wago.com/2009-113/000-005)



**Item no.: 2009-113/000-017**

WMB-Inline; for Smart Printer; 2300 pieces on roll; plain; snap-on type; light green

[www.wago.com/2009-113/000-017](http://www.wago.com/2009-113/000-017)



**Item no.: 2009-113/000-006**

WMB-Inline; for Smart Printer; 2300 pieces on roll; plain; snap-on type; blue

[www.wago.com/2009-113/000-006](http://www.wago.com/2009-113/000-006)



**Item no.: 2009-113/000-024**

WMB-Inline; for Smart Printer; 2300 pieces on roll; plain; snap-on type; violet

[www.wago.com/2009-113/000-024](http://www.wago.com/2009-113/000-024)



**Item no.: 2009-113/000-023**

WMB-Inline; for Smart Printer; 2300 pieces on roll; plain; snap-on type; green

[www.wago.com/2009-113/000-023](http://www.wago.com/2009-113/000-023)

**Item no.: 793-3501**

WMB marking card; as card; plain; snap-on type; white

[www.wago.com/793-3501](http://www.wago.com/793-3501)

End plate

End plate



**Item no.: 209-191**

Separator for Ex e/Ex i applications; 3 mm thick; 120 mm wide; orange

[www.wago.com/209-191](http://www.wago.com/209-191)

Subject to changes. Please also observe the further product documentation!

WAGO GmbH & Co. KG

Hansastr. 27

32423 Minden

Phone: +49571 887-0 | Fax: +49571 887-169

Email: [info.de@wago.com](mailto:info.de@wago.com) | Web: [www.wago.com](http://www.wago.com)

Do you have any questions about our products?

We are always happy to take your call at +49 (571) 887-44222.



Item no.: 209-190

Separator for Ex e/Ex i applications; 3 mm thick; 90 mm wide; orange

## Downloads

### Documentation

#### Bid Text

2200-1201 X81 - Datei	19-Feb-2019	xml 3.8 kB	Download
--------------------------	-------------	---------------	----------

2200-1201 docx - Datei	08-Aug-2018	docx 14.9 kB	Download
---------------------------	-------------	-----------------	----------

#### Additional Information

Technical explanations		pdf 2.2 MB	Download
------------------------	--	---------------	----------

## CAD/CAE-Data

### CAD data

2D/3D Models 2200-1201		URL	Download
------------------------	--	-----	----------

### CAE data

EPLAN Data Portal 2200-1201		URL	Download
-----------------------------	--	-----	----------

ZUKEN Portal 2200-1201		URL	Download
------------------------	--	-----	----------

## Environmental Product Compliance

### Compliance Search

Environmental Product Compliance 2200-1201		URL	Download
--	--	-----	----------

2-conductor through terminal block; with push-button; 1 mm<sup>2</sup>; with test port; side and center marking; for DIN-rail 35 x 15 and 35 x 7.5; Push-in CAGE CLAMP®; 1,00 mm<sup>2</sup>; gray

## Installation Notes

### Conductor termination

Subject to changes. Please also observe the further product documentation!

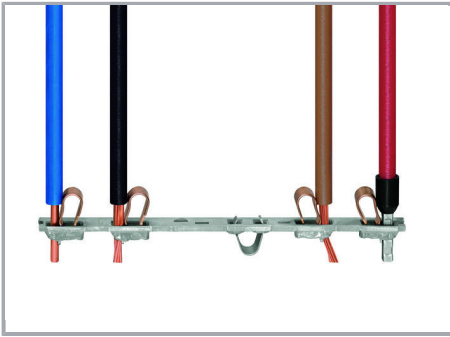

All conductor types at a glance



Push-in termination of solid and ferruled conductors



Insert fine-stranded conductors via operating tool.



Removing all conductors via operating tool.

### Commoning

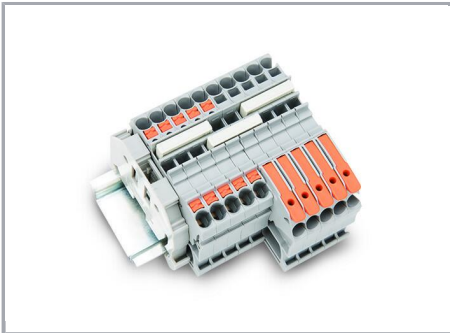

Insert a push-in type jumper bar and push down until it hits the backstop.



Commoning with step-down jumpers.

### Testing

Subject to changes. Please also observe the further product documentation!



Testing with a 2 mm Ø test plug (max. 42 V).

### Marking

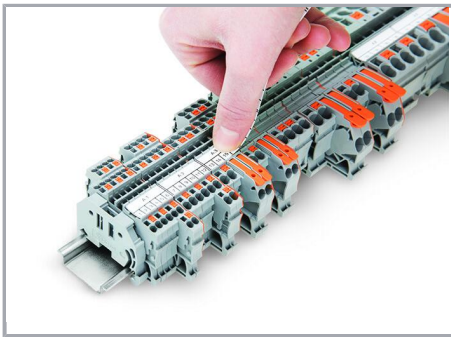

Snapping a marking strip into a marker slot.

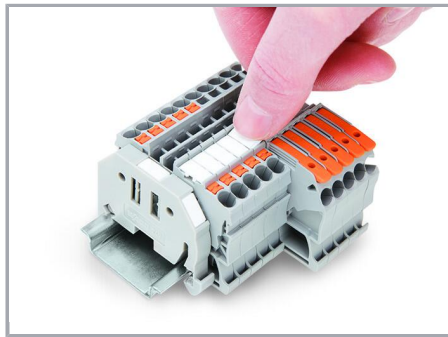

Snapping a marking strip into the marker slot.

### Product family

#### TOPJOB® S

TOPJOB® S: In various industrial applications and modern building installations, WAGO's wide and versatile range of rail-mount terminal blocks provides more than just reliable electrical connections.

[Show all products from the family](#)

Subject to changes. Please also observe the further product documentation!