

HSMQ-C1xx and HSMR-C1xx

High Performance Chip LED



Data Sheet

HSMQ-C110, HSMQ-C120, HSMQ-C150, HSMQ-C170, HSMQ-C177, HSMQ-C190, HSMQ-C191, HSMQ-C197, HSMQ-C265, HSMR-C110, HSMR-C120, HSMR-C130, HSMR-C150, HSMR-C170, HSMR-C177, HSMR-C190, HSMR-C191, HSMR-C197, HSMR-C265



Description

These small chip-type LEDs utilize high efficient and high brightness InGaN material to deliver competitively priced high performance blue and green. These 520 nm green and 470 nm blue are unique hues which provide color differentiation to a product.

These ChipLEDs come in either top emitting packages (HSMx-C130, C150, C170, C177, C190, C191, C197), in side emitting packages (HSMx-C110, C120) or in a reverse mount package (C265). The side emitting package is especially suitable for LCD backlighting application. The top emitting packages, with their wide viewing angle, are suitable for direct backlighting application or being used with light pipes. In order to facilitate pick and place operation, these ChipLEDs are shipped in tape and reel with 4000 units per reel for HSMx-C120, C130, C170, C177, C190, C191 and C197 packages, and 3000 units per reel for HSMx-C110, C150 and C265 packages. All packages are compatible with IR soldering and binned by both color and intensity.

Features

- High brightness
- Small size
- Industrial standard footprint
- Diffused optics
- Top emitting or right angle emitting
- Compatible with IR soldering
- Compatible for use with light piping
- Available in 8 mm tape on 7" diameter reel
- Reel sealed in zip locked moisture barrier bags

Applications

- LCD backlighting
- Push button backlighting
- Front panel indicator
- Symbol indicator
- Microdisplays
- Small message panel signage

CAUTION: HSMQ-Cxxx and HSMR-Cxxx LEDs are Class 1A ESD sensitive per JESD22-A114C.01. Please observe appropriate precautions during handling and processing. Refer to Avago Technologies Application Note AN-1142 for additional details.

Package Dimensions

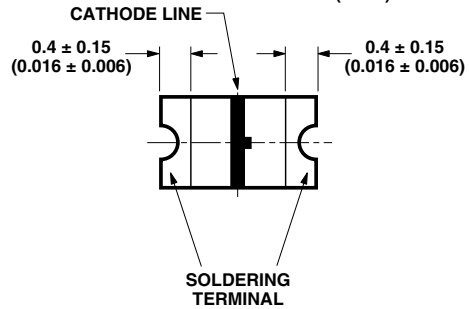
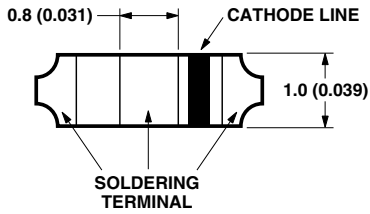
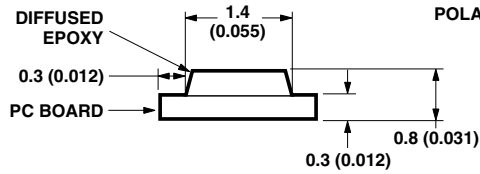
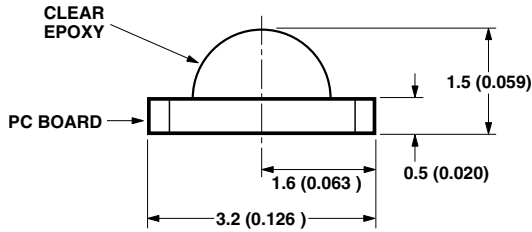
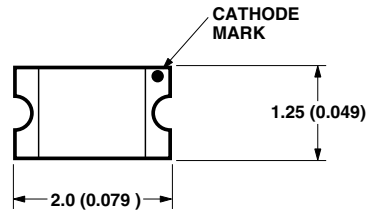
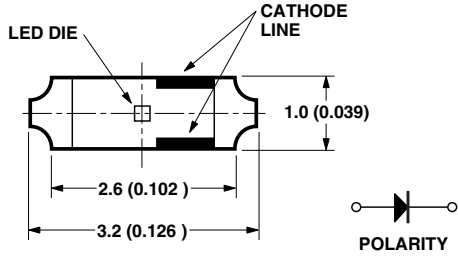

HSMx-C110

HSMx-C170

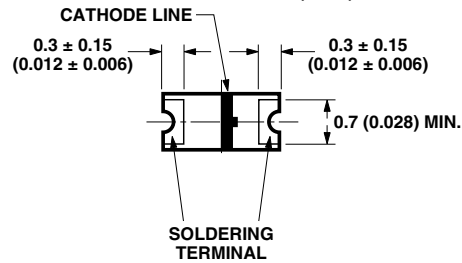
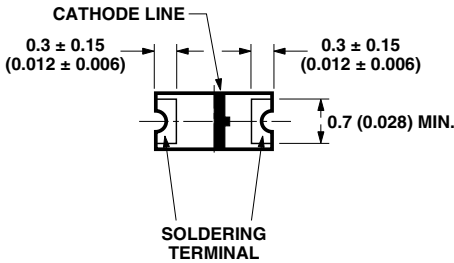
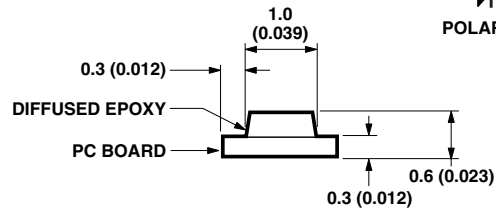
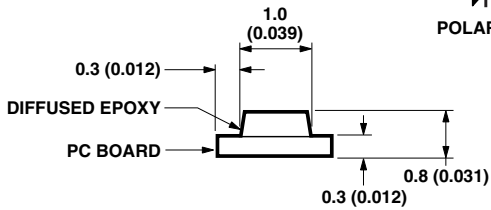
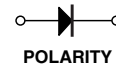
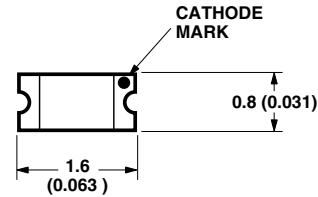
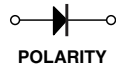
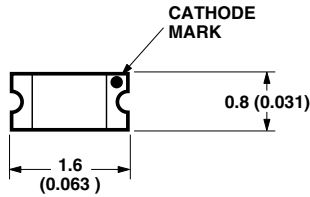

HSMx-C190

HSMx-C191

- NOTES:
1. ALL DIMENSIONS IN MILLIMETERS (INCHES).
2. TOLERANCE IS ± 0.1 mm (± 0.004 IN.) UNLESS OTHERWISE SPECIFIED.

Package Dimensions, continued

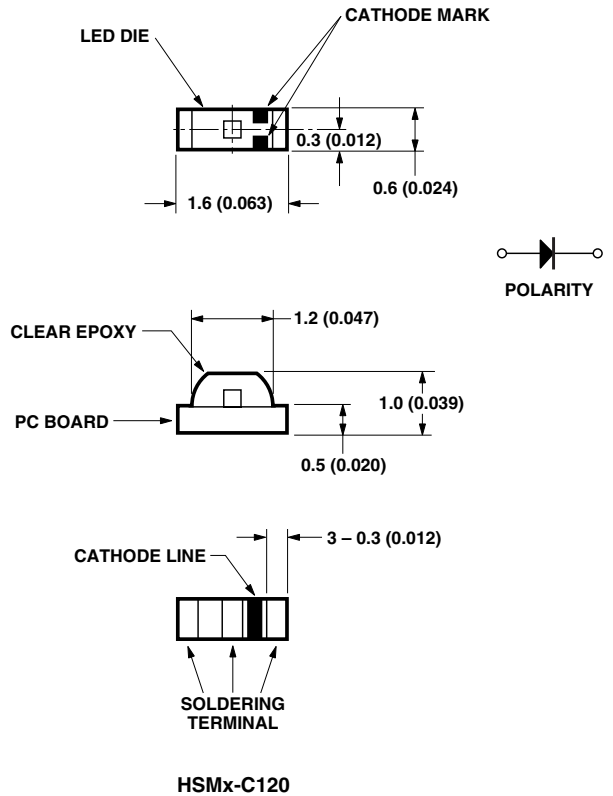
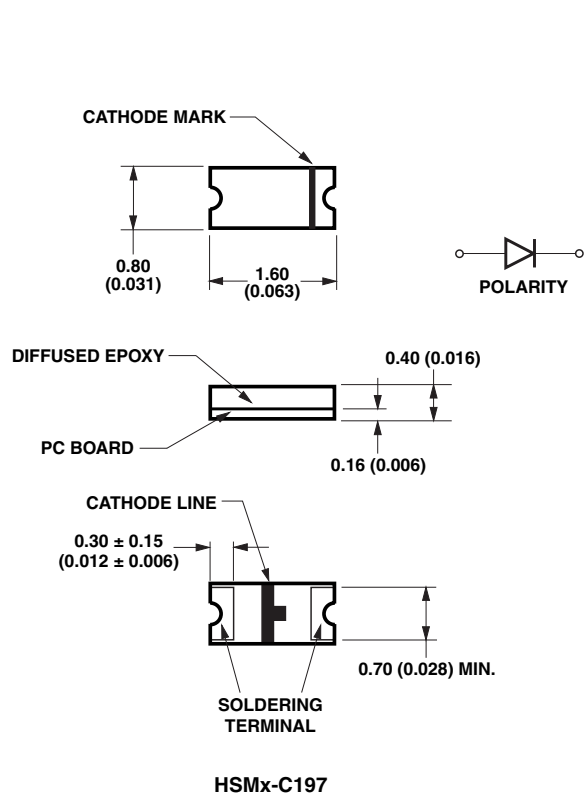
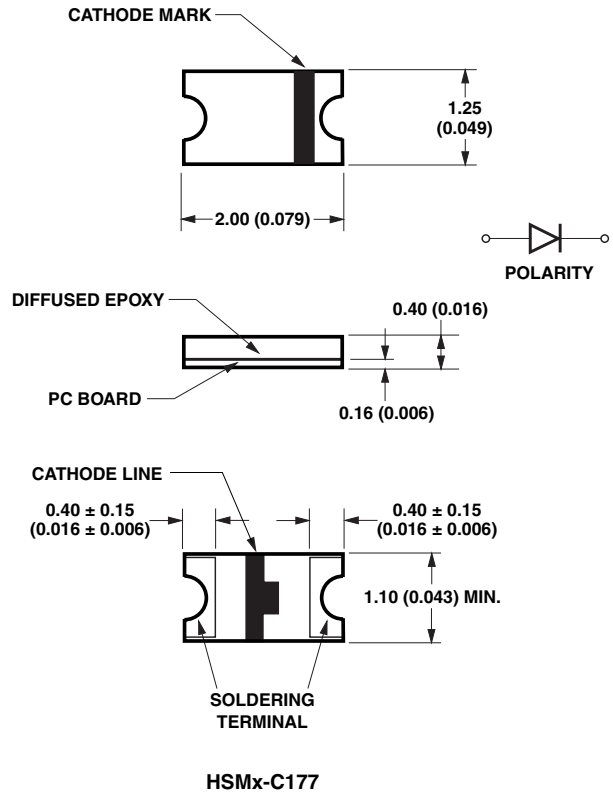
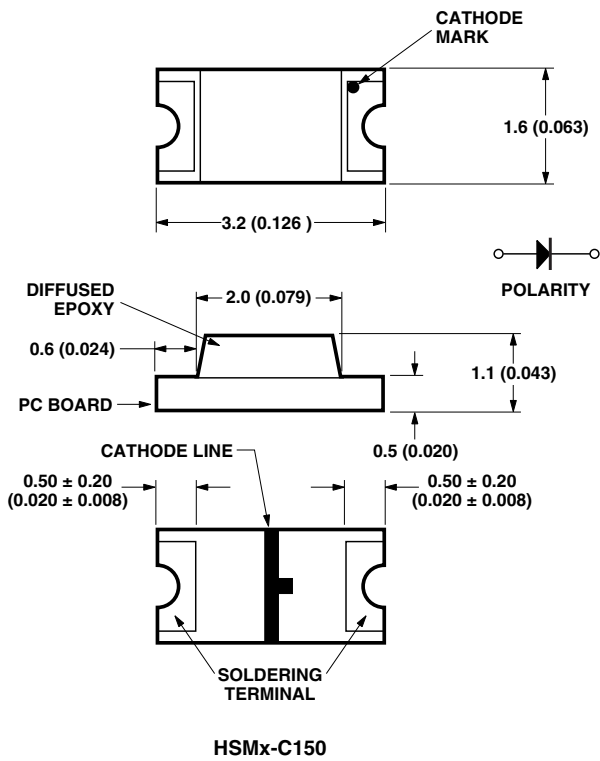

- NOTES:**
1. ALL DIMENSIONS IN MILLIMETERS (INCHES).
 2. TOLERANCE IS ± 0.1 mm (± 0.004 IN.) UNLESS OTHERWISE SPECIFIED.

Package Dimensions, continued

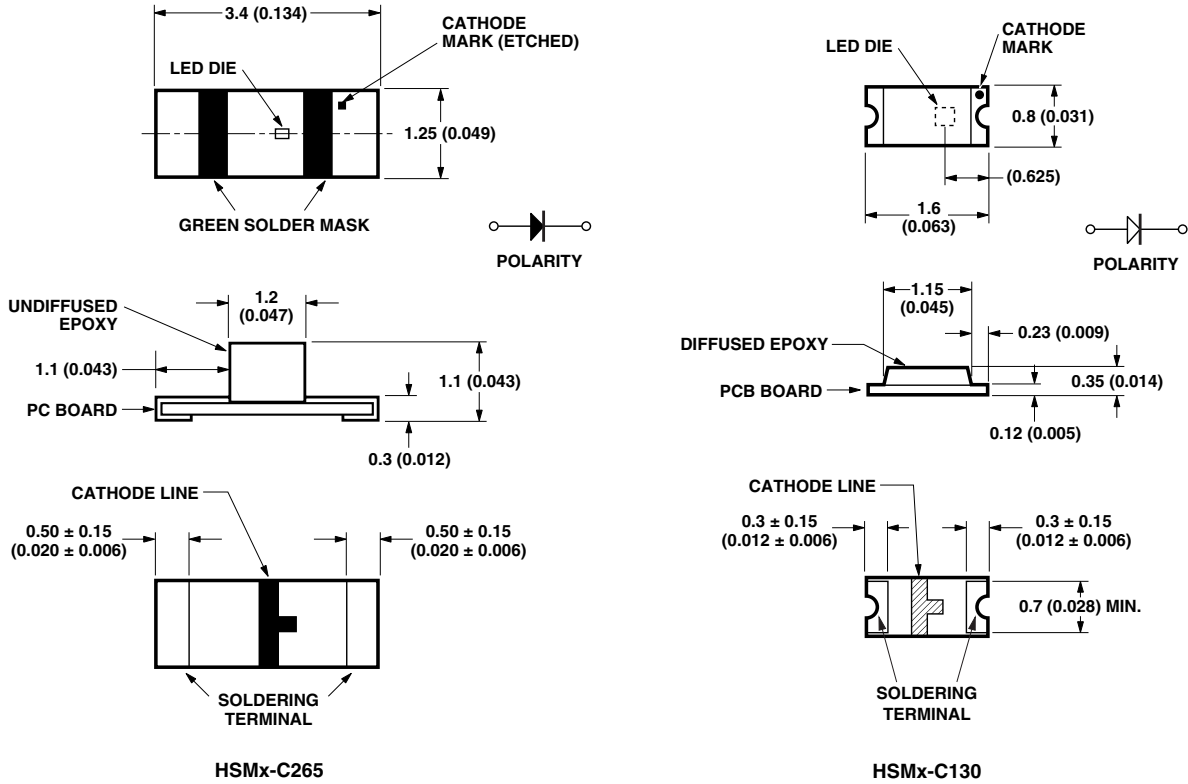

NOTES:

1. ALL DIMENSIONS IN MILLIMETERS (INCHES).
2. TOLERANCE IS ± 0.1 mm (± 0.004 IN.) UNLESS OTHERWISE SPECIFIED.

Device Selection Guide

| Package Dimension (mm) ^{[1], [2]} | InGaN Green | InGaN Blue | Package Description |
|--|-------------|------------|------------------------|
| 3.2(L) x 1.5(W) x 1.0(H) | HSMQ-C110 | HSMR-C110 | Untinted, Non-diffused |
| 1.6(L) x 1.0(W) x 0.6(H) | HSMQ-C120 | HSMR-C120 | Untinted, Non-diffused |
| 1.6(L) x 0.8(W) x 0.35(H) | – | HSMR-C130 | Untinted, Diffused |
| 3.2(L) x 1.6(W) x 1.1(H) | HSMQ-C150 | HSMR-C150 | Untinted, Diffused |
| 2.0(L) x 1.25(W) x 0.8(H) | HSMQ-C170 | HSMR-C170 | Untinted, Diffused |
| 2.0(L) x 1.25(W) x 0.4(H) | HSMQ-C177 | HSMR-C177 | Untinted, Diffused |
| 1.6(L) x 0.8(W) x 0.8(H) | HSMQ-C190 | HSMR-C190 | Untinted, Diffused |
| 1.6(L) x 0.8(W) x 0.6(H) | HSMQ-C191 | HSMR-C191 | Untinted, Diffused |
| 1.6(L) x 0.8(W) x 0.4(H) | HSMQ-C197 | HSMR-C197 | Untinted, Diffused |
| 3.4(L) x 1.25(W) x 1.1(H) | HSMQ-C265 | HSMR-C265 | Untinted, Non-diffused |

Notes: 1. Dimensions in mm. 2. Tolerance ± 0.1 mm unless otherwise noted.

Absolute Maximum Ratings at $T_A = 25^\circ\text{C}$

| Parameter | HSMQ-Cxxx HSMR-Cxxx | Units |
|---|--|------------------|
| DC Forward Current ^[1] | 20 | mA |
| Power Dissipation | 78 | mW |
| Reverse Voltage ($I_R = 100 \mu\text{A}$) | 5 | V |
| LED Junction Temperature | 95 | $^\circ\text{C}$ |
| Operating Temperature Range | -40 to +85 | $^\circ\text{C}$ |
| Storage Temperature Range | -40 to +85 | $^\circ\text{C}$ |
| Soldering Temperature | See reflow soldering profile (Figures 11 & 12) | |

Note: 1. Derate linearly as shown in Figure 4.

Electrical Characteristics at $T_A = 25^\circ\text{C}$

| Part Number | Forward Voltage V_F (Volts) @ $I_F = 20\text{ mA}$ @ $I_R = 100\ \mu\text{A}$ | | Reverse Breakdown V_R (Volts) $f = 1\text{ MHz}$ | Capacitance C (pF), $V_F = 0$, $R\theta_{J-PIN}$ ($^\circ\text{C/W}$) | Thermal Resistance |
|---------------------|---|------|--|--|-----------------------|
| | Typ. | Max. | Min. | Typ. | Typ. |
| HSMQ-C110/C150 | 3.4 | 3.9 | 5 | 140 | 450 |
| HSMR-C110/C150 | 3.4 | 3.9 | 5 | 140 | 450 |
| HSMQ-C120 | 3.4 | 3.9 | 5 | 100 | 450 |
| HSMR-C120/C130 | 3.4 | 3.9 | 5 | 100 | 450 |
| HSMQ-C170/C190/C191 | 3.4 | 3.9 | 5 | 110 | 300 |
| HSMR-C170/C190/C191 | 3.4 | 3.9 | 5 | 110 | 300 |
| HSMQ-C177/C197 | 3.4 | 3.9 | 5 | 110 | 350 |
| HSMR-C177/C197 | 3.4 | 3.9 | 5 | 110 | 350 |
| HSMQ-C265 | 3.4 | 3.9 | 5 | 65 | 300 |
| HSMR-C265 | 3.4 | 3.9 | 5 | 65 | 300 |

V_F Tolerance: $\pm 0.1\text{ V}$

Optical Characteristics at $T_A = 25^\circ\text{C}$

| Part Number | Color | Luminous Intensity I_V (mcd) @ 20 mA ^[1] | | Color, Peak Wavelength λ_{peak} (nm) | Viewing Dominant Wavelength λ_d ^[2] (nm) | Luminous Angle $2\ \theta_{1/2}$ Degrees ^[3] | Efficacy η_V (lm/w) |
|-----------------------|-------|--|------|--|--|--|--------------------------------|
| | | Min. | Typ. | Typ. | Typ. | Typ. | Typ. |
| HSMQ-C110 | Green | 45 | 150 | 520 | 527 | 130 | 500 |
| HSMQ-C120 | Green | 45 | 145 | 520 | 527 | 155 | 500 |
| HSMQ-C150/170/190/191 | Green | 45 | 145 | 520 | 527 | 140 | 500 |
| HSMQ-C177/197 | Green | 45 | 145 | 520 | 527 | 130 | 500 |
| HSMQ-C265 | Green | 45 | 140 | 520 | 527 | 150 | 500 |
| HSMR-C110 | Blue | 18 | 60 | 469 | 473 | 130 | 88 |
| HSMR-C120 | Blue | 18 | 55 | 469 | 473 | 155 | 88 |
| HSMR-C130 | Blue | 18 | 55 | 469 | 473 | 145 | 88 |
| HSMR-C150/170/190/191 | Blue | 18 | 55 | 469 | 473 | 140 | 88 |
| HSMR-C177/197 | Blue | 18 | 55 | 469 | 473 | 130 | 88 |
| HSMR-C265 | Blue | 18 | 45 | 469 | 473 | 150 | 88 |

Notes:

1. The luminous intensity, I_V , is measured at the peak of the spatial radiation pattern which may not be aligned with the mechanical axis of the lamp package.
2. The dominant wavelength, λ_d , is derived from the CIE Chromaticity Diagram and represents the perceived color of the device.
3. $\theta_{1/2}$ is the off-axis angle where the luminous intensity is 1/2 the peak intensity.

Color Bin Limits^[1]

Blue Color Bins^[1]

| Bin ID | Dom. Wavelength (nm) | |
|--------|----------------------|-------|
| | Min. | Max. |
| A | 460.0 | 465.0 |
| B | 465.0 | 470.0 |
| C | 470.0 | 475.0 |
| D | 475.0 | 480.0 |

Tolerance: $\pm 1\text{ nm}$

Note:

1. Bin categories are established for classification of products. Products may not be available in all categories. Please contact your Avago representative for information on currently available bins.

InGaN Green Color Bins^[1]

| Bin ID | Dom. Wavelength (nm) | |
|--------|----------------------|-------|
| | Min. | Max. |
| A | 515.0 | 520.0 |
| B | 520.0 | 525.0 |
| C | 525.0 | 530.0 |
| D | 530.0 | 535.0 |

Tolerance: $\pm 1\text{ nm}$

Light Intensity (Iv) Bin Limits^[1]

| Bin ID | Intensity (mcd) | | Bin ID | Intensity (mcd) | |
|--------|-----------------|-------|--------|-----------------|---------|
| | Min. | Max. | | Min. | Max. |
| A | 0.11 | 0.18 | N | 28.50 | 45.00 |
| B | 0.18 | 0.29 | P | 45.00 | 71.50 |
| C | 0.29 | 0.45 | Q | 71.50 | 112.50 |
| D | 0.45 | 0.72 | R | 112.50 | 180.00 |
| E | 0.72 | 1.10 | S | 180.00 | 285.00 |
| F | 1.10 | 1.80 | T | 285.00 | 450.00 |
| G | 1.80 | 2.80 | U | 450.00 | 715.00 |
| H | 2.80 | 4.50 | V | 715.00 | 1125.00 |
| J | 4.50 | 7.20 | W | 1125.00 | 1800.00 |
| K | 7.20 | 11.20 | X | 1800.00 | 2850.00 |
| L | 11.20 | 18.00 | Y | 2850.00 | 4500.00 |
| M | 18.00 | 28.50 | | | |

Tolerance: $\pm 15\%$

Notes:

- Bin categories are established for classification of products. Products may not be available in all categories. Please contact your Avago representative for information on currently available bins.
- The Iv binning specification set-up is for lowest allowable Iv binning only. There are no upper Iv bin limits.

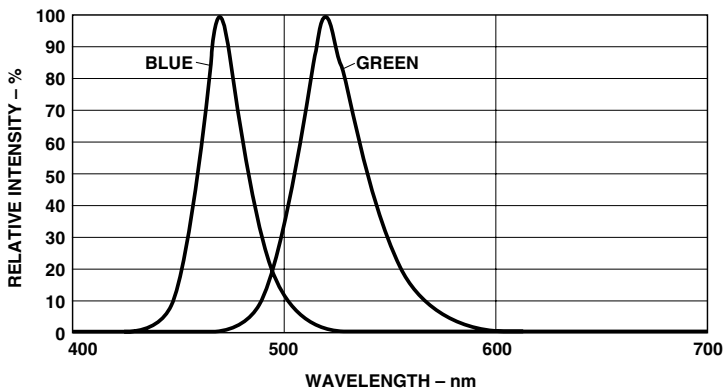

Figure 1. Relative intensity vs. wavelength.

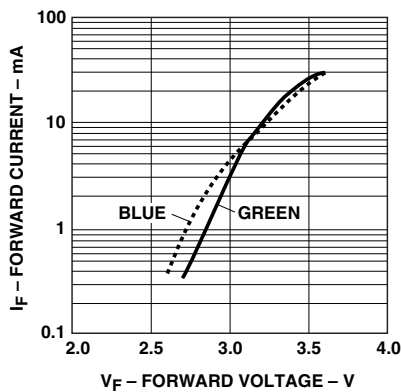

Figure 2. Forward current vs. forward voltage.

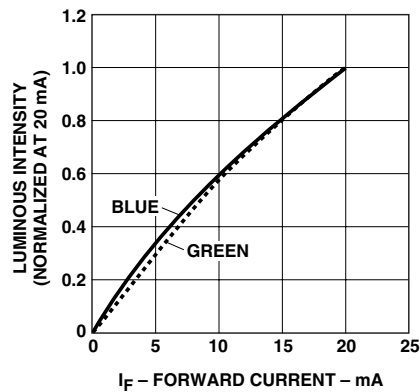

Figure 3. Luminous intensity vs. forward current.

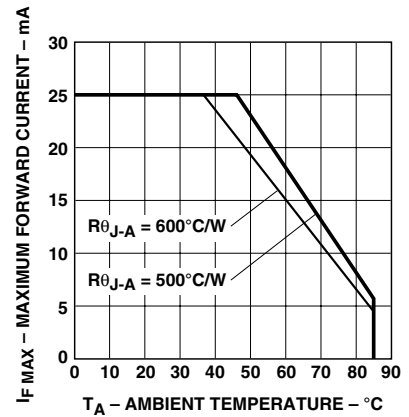

Figure 4. Maximum forward current vs. ambient temperature.

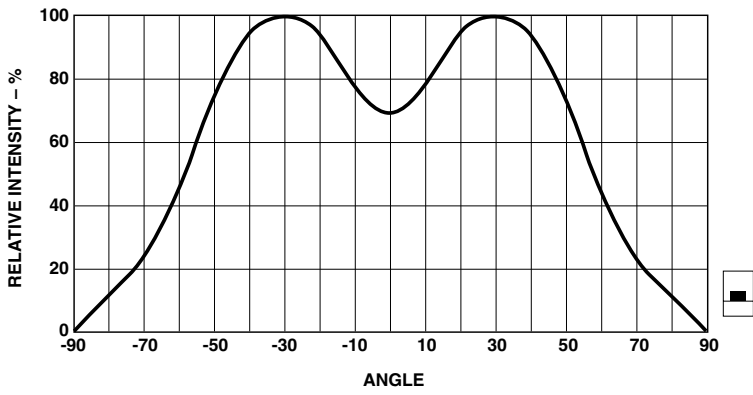
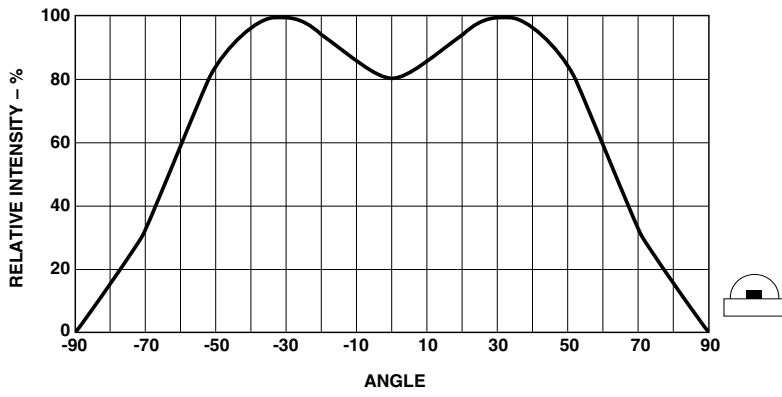

Figure 5. Relative intensity vs. angle for HSMx-C110.

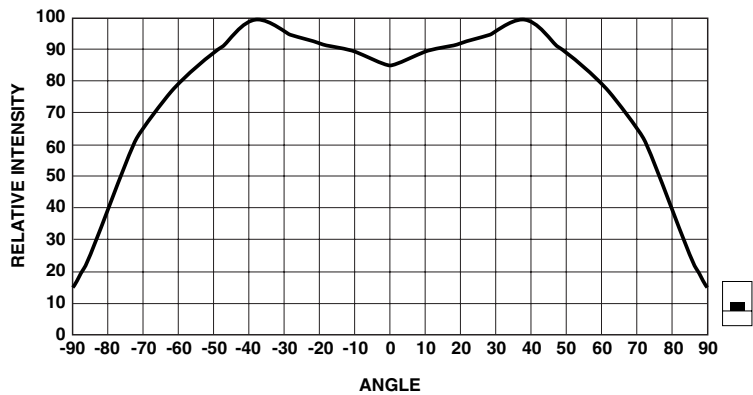
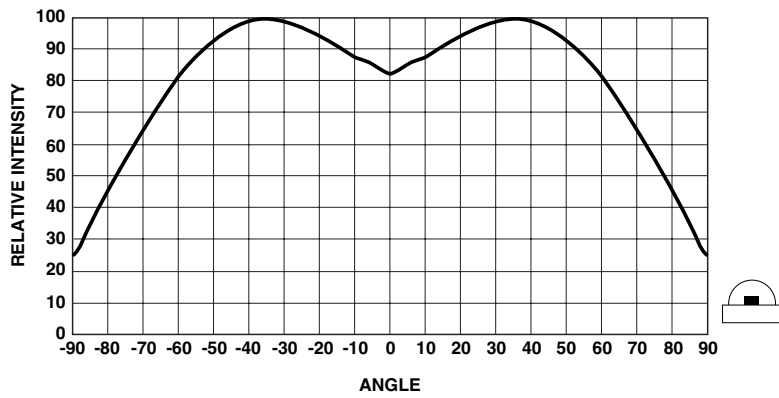

Figure 6. Relative intensity vs. angle for HSMx-C120.

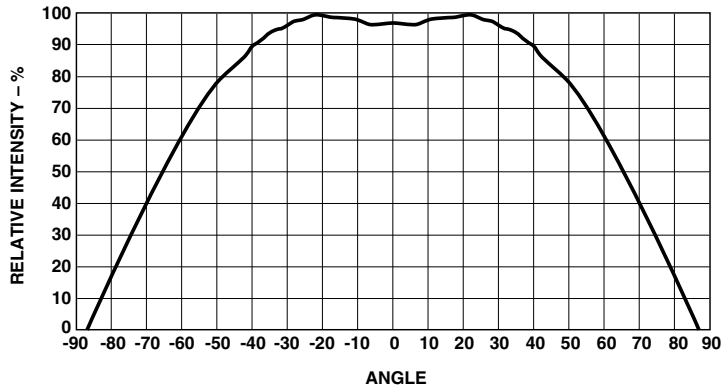

Figure 7. Relative intensity vs. angle for HSMx-C177 and C197.

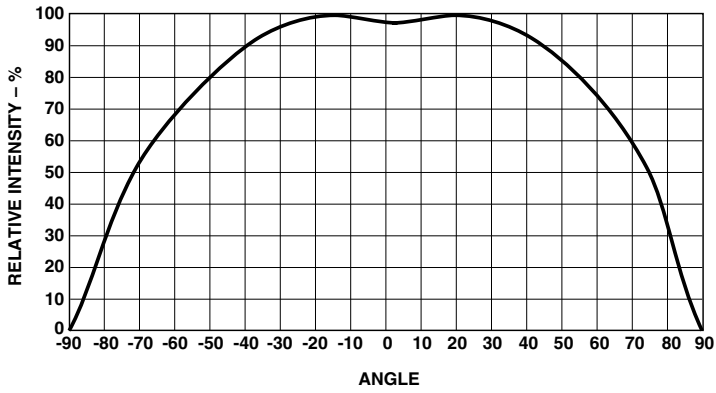

Figure 8. Relative intensity vs. angle for HSMx-C130.

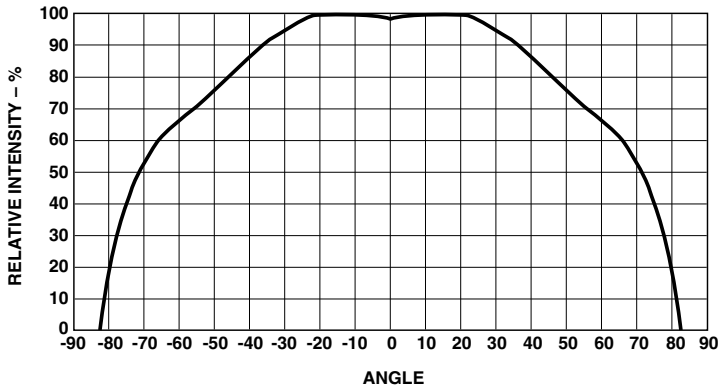

Figure 9. Relative intensity vs. angle for HSMx-C170, C190, C191, and C150.

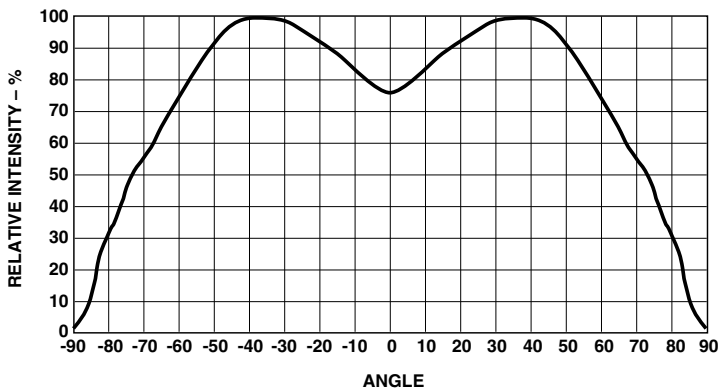

Figure 10. Relative intensity vs. angle for HSMx-C265.

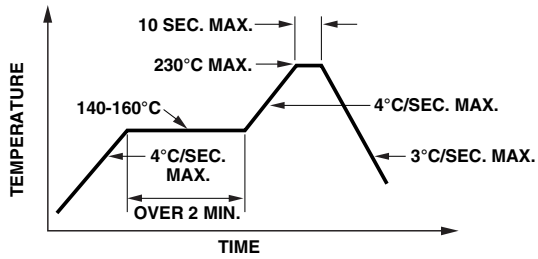

Figure 11. Recommended reflow soldering profile.

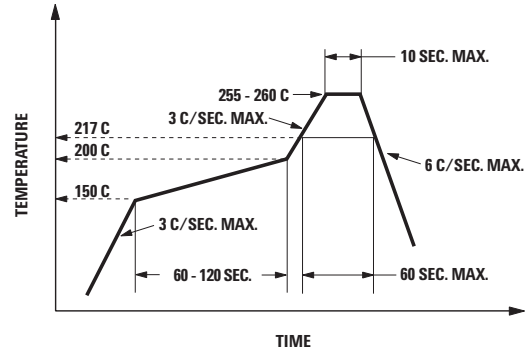

Figure 12. Recommended Pb-free reflow soldering profile.

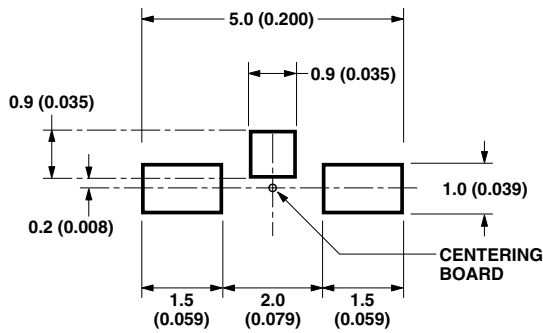

Figure 13. Recommended soldering pattern for HSMx-C110.

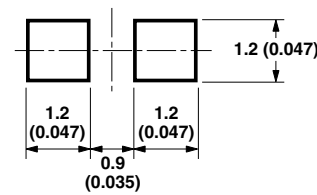

Figure 14. Recommended soldering pattern for HSMx-C170/177.

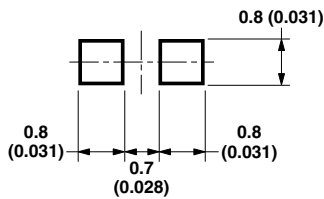

Figure 15. Recommended soldering pattern for HSMx-C130/190/191/197.

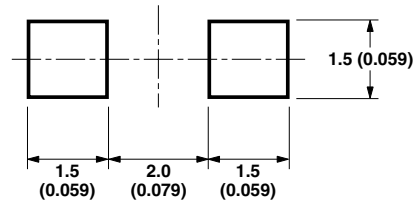

Figure 16. Recommended soldering pattern for HSMx-C150.

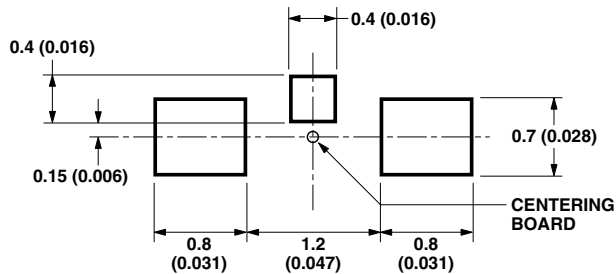

Figure 17. Recommended soldering pattern for HSMx-C120.

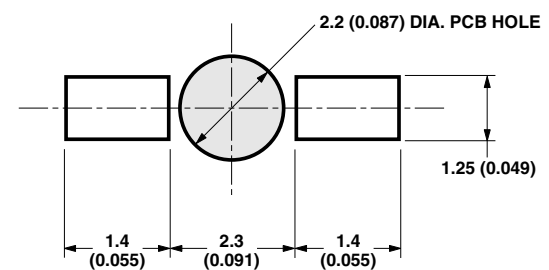

Figure 18. Recommended soldering pattern for HSMx-C265.

NOTE:
1. ALL DIMENSIONS IN MILLIMETERS (INCHES).

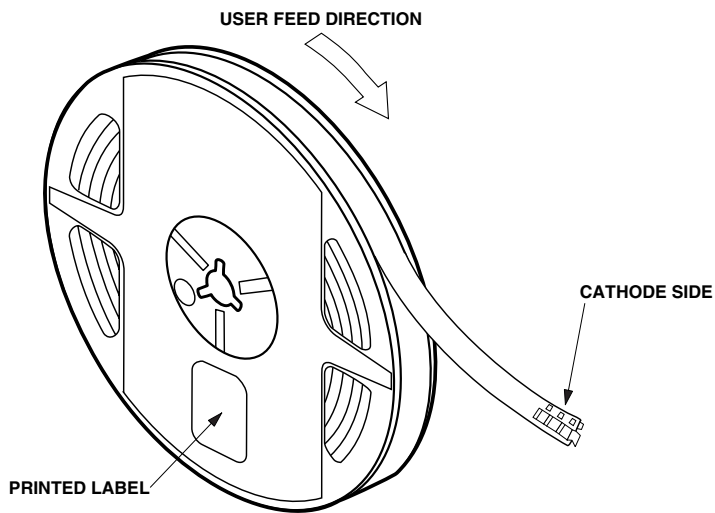

Figure 19. Reeling orientation.

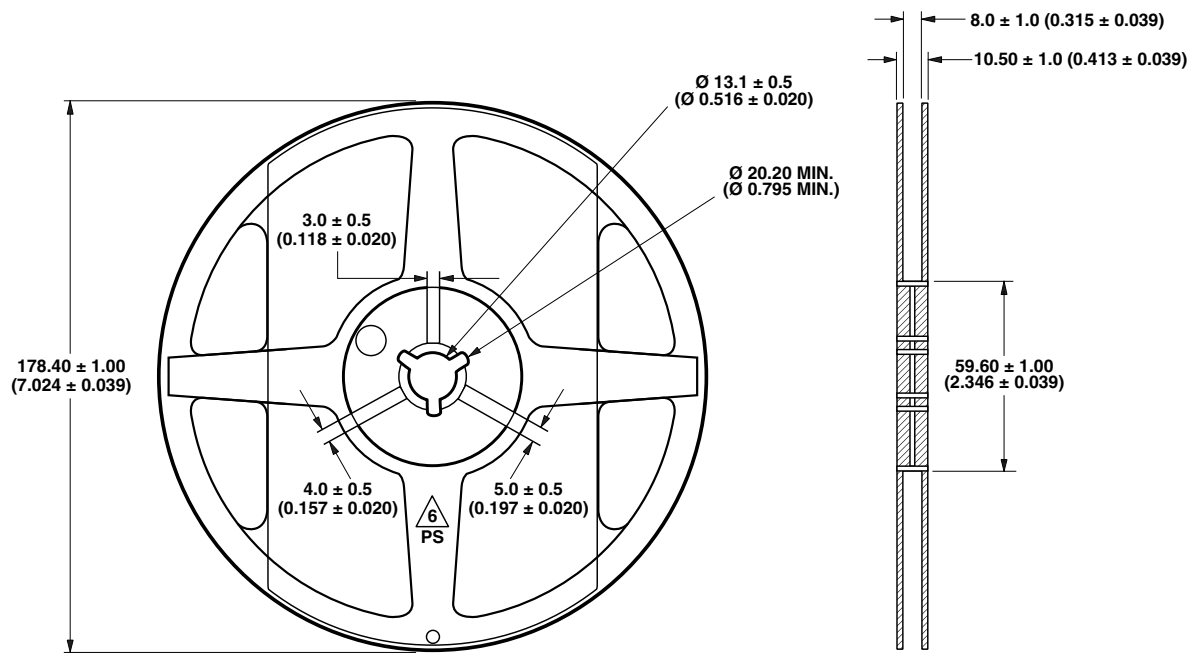

Figure 20. Reel dimensions.

NOTE:

1. ALL DIMENSIONS IN MILLIMETERS (INCHES).

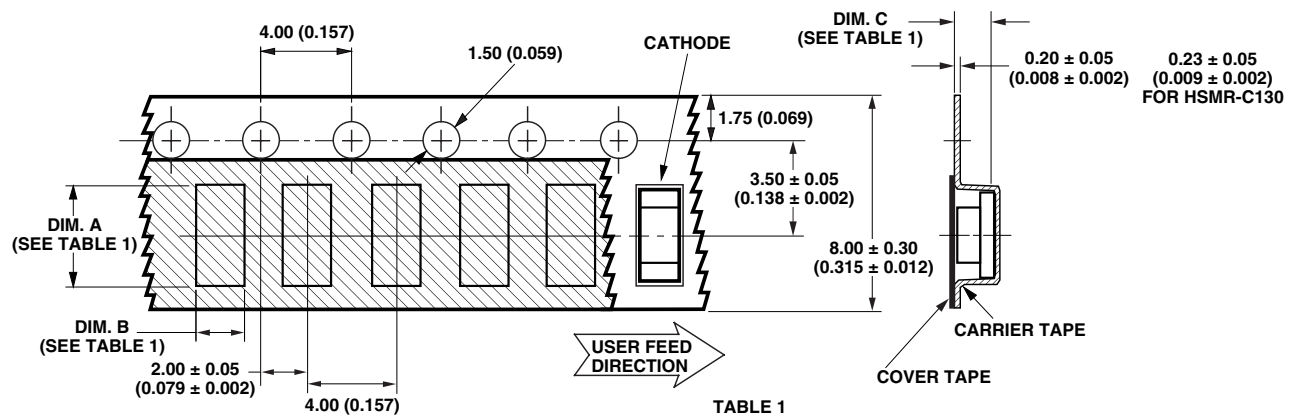

TABLE 1
DIMENSIONS IN MILLIMETERS (INCHES)

| PART NUMBER | DIM. A ± 0.10 (0.004) | DIM. B ± 0.10 (0.004) | DIM. C ± 0.10 (0.004) |
|------------------|--------------------------|--------------------------|--------------------------|
| HSMx-C110 SERIES | 3.40 (0.134) | 1.70 (0.067) | 1.20 (0.047) |
| HSMx-C120 SERIES | 1.90 (0.075) | 1.15 (0.045) | 0.75 (0.030) |
| HSMx-C150 SERIES | 3.50 (0.138) | 1.88 (0.074) | 1.27 (0.050) |
| HSMx-C170 SERIES | 2.30 (0.091) | 1.45 (0.057) | 0.95 (0.037) |
| HSMx-C177 SERIES | 2.30 (0.091) | 1.40 (0.055) | 0.60 (0.024) |
| HSMx-C190 SERIES | 1.75 (0.069) | 0.90 (0.035) | 0.90 (0.035) |
| HSMx-C191 SERIES | 1.85 (0.073) | 0.88 (0.035) | 0.85 (0.033) |
| HSMx-C197 SERIES | 1.75 (0.069) | 0.95 (0.037) | 0.60 (0.024) |

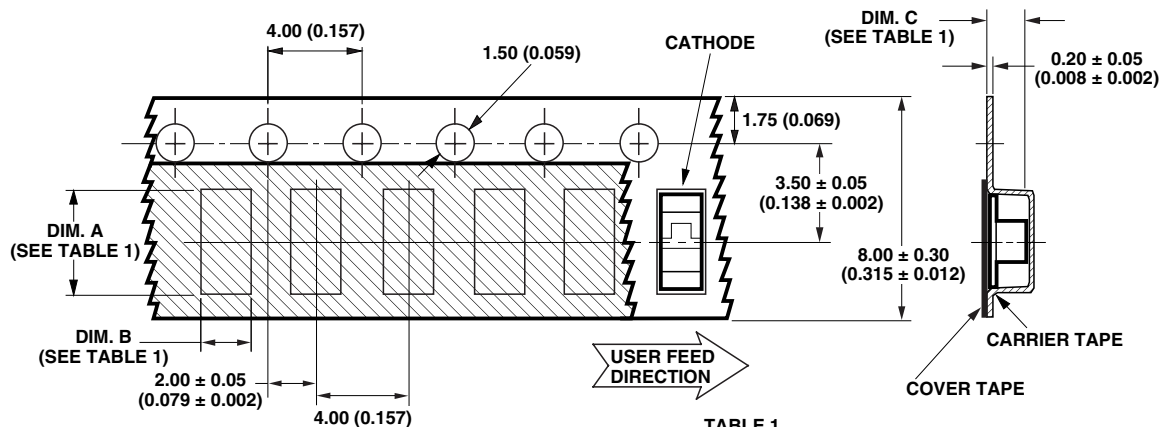
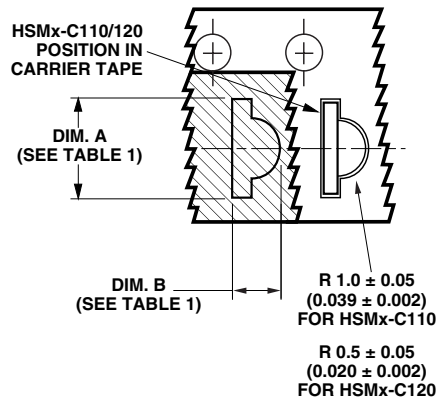

TABLE 1
DIMENSIONS IN MILLIMETERS (INCHES)

| PART NUMBER | DIM. A ± 0.10 (0.004) | DIM. B ± 0.10 (0.004) | DIM. C ± 0.10 (0.004) |
|------------------|--------------------------|--------------------------|--------------------------|
| HSMx-C265 SERIES | 3.70 (0.146) | 1.45 (0.057) | 1.30 (0.051) |

Figure 21. Tape dimensions.

NOTE:
1. ALL DIMENSIONS IN MILLIMETERS (INCHES).

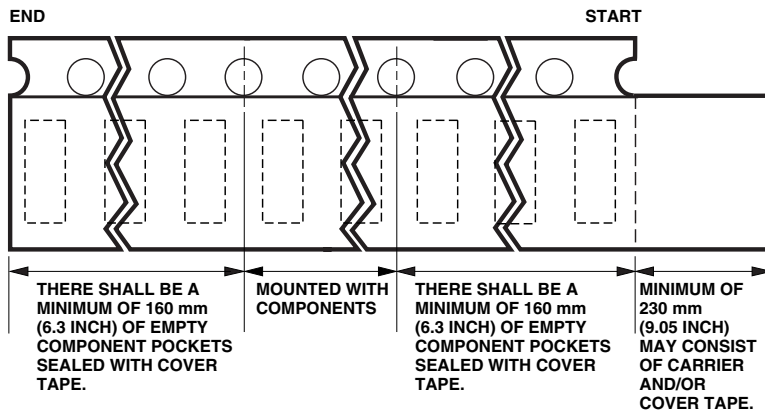

Figure 22. Tape leader and trailer dimensions.

NOTES:

1. ALL DIMENSIONS IN MILLIMETERS (INCHES).
2. TOLERANCE IS ± 0.1 mm (± 0.004 IN.) UNLESS OTHERWISE SPECIFIED.

Convective IR Reflow Soldering

For more information on IR reflow soldering, refer to Application Note 1060, *Surface Mounting SMT LED Indicator Components*.

Storage Condition: 5 to 30°C @ 60% RH max.

Baking is required under the condition:

- a) Humidity Indicator Card is $>10\%$ when read at $23 \pm 5^\circ\text{C}$
- b) Device exposed to factory conditions $<30^\circ\text{C}/60\%$ RH more than 672 hours.

Baking recommended condition: $60 \pm 5^\circ\text{C}$ for 20 hours.

For product information and a complete list of distributors, please go to our website: www.avagotech.com

Avago, Avago Technologies, and the A logo are trademarks of Avago Technologies in the United States and other countries. Data subject to change. Copyright © 2005-2010 Avago Technologies. All rights reserved. Obsoletes AV01-0521EN AV02-0977EN - April 9, 2010

Avago
TECHNOLOGIES