

● General Description

The AGM025N13LL combines advanced trench MOSFET technology with a low resistance package to provide extremely low $R_{DS(ON)}$.

This device is ideal for load switch and battery protection applications.

● Features

- Advance high cell density Trench technology
- Low $R_{DS(ON)}$ to minimize conductive loss
- Low Gate Charge for fast switching
- Low Thermal resistance

● Application

- MB/VGA Vcore
- SMPS 2nd Synchronous Rectifier
- POL application
- BLDC Motor driver

Package Marking and Ordering Information

Device Marking	Device	Device Package	Reel Size	Tape width	Quantity
AGM025N13LL	AGM025N13LL	TOLL-8L	----	----	2000

Table 1. Absolute Maximum Ratings (TA=25°C)

Symbol	Parameter	Value	Unit
VDS	Drain-Source Voltage (VGS=0V)	135	V
VGS	Gate-Source Voltage (VDS=0V)	±20	V
ID	Drain Current-Continuous(Tc=25°C) (Note 1)	305	A
	Drain Current-Continuous(Tc=100°C)	215	A
IDM (pluse)	Drain Current-Continuous@ Current-Pulsed (Note 2)	600	A
PD	Maximum Power Dissipation(Tc=25°C)	357	w
	Maximum Power Dissipation(Tc=100°C)	143	w
EAS	Avalanche energy (Note 3)	1500	mJ
TJ,TSTG	Operating Junction and Storage Temperature Range	-55 To 175	°C

Table 2. Thermal Characteristic

Symbol	Parameter	Typ	Max	Unit
RθJA	Thermal Resistance Junction-ambient (Steady State) ¹	---	61	°C/W
RθJC	Thermal Resistance Junction-Case ¹	---	0.35	°C/W

Product Summary

BVDSS	RDS(ON)	ID
135V	2.9mΩ	305A

TOLL-8L Pin Configuration

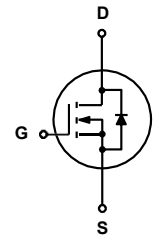
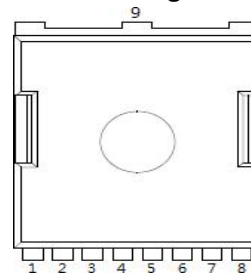

Pin	Description
1	Gate(G)
2,3,4,5,6,7,8	Source(S)
9	Drain(D)

Table 3. Electrical Characteristics (TA=25°C unless otherwise noted)

Symbol	Parameter	Conditions	Min	Typ	Max	Unit
On/Off States						
BVDSS	Drain-Source Breakdown Voltage	VGS=0V ID=250μA	135	--	--	V
IDSS	Zero Gate Voltage Drain Current	VDS=135V,VGS=0V	--	--	1	μA
IGSS	Gate-Body Leakage Current	VGS=±20V,VDS=0V	--	--	±100	nA
VGS(th)	Gate Threshold Voltage	VDS=VGS,ID=250μA	2.0	--	4.0	V
gFS	Forward Transconductance	VDS=5V,ID=25A	--	--	--	S
RDS(on)	Drain-Source On-State Resistance	VGS=10V, ID=50A	--	2.9	3.5	mΩ
		VGS=4.5V, ID=25A	--	3.5	4.5	mΩ
Dynamic Characteristics						
Ciss	Input Capacitance	VDS=70V,VGS=0V, F=1MHZ	--	8362	--	pF
Coss	Output Capacitance		--	860	--	pF
Crss	Reverse Transfer Capacitance		--	14.6	--	pF
Rg	Gate resistance	VGS=0V, VDS=0V,f=1.0MHz	--	--	--	Ω
Switching Times						
td(on)	Turn-on Delay Time	VGS=10V,VDS=70V ID=50A,RGEN=4.5Ω	--	1.0	--	nS
tr	Turn-on Rise Time		--	33	--	nS
td(off)	Turn-Off Delay Time		--	95	--	nS
tf	Turn-Off Fall Time		--	75	--	nS
Qg	Total Gate Charge	VGS=10V, VDS=70V, ID=50A	--	1387	--	nC
Qgs	Gate-Source Charge		--	34	--	nC
Qgd	Gate-Drain Charge		--	32	--	nC
Source-Drain Diode Characteristics						
ISD	Source-Drain Current(Body Diode)		--	--	305	A
VSD	Forward on Voltage	VGS=0V,IS=50A	--	--	1.3	V
trr	Reverse Recovery Time	IF=50A , dI/dt=100A/μs , TJ=25°C	--	130	--	ns
Qrr	Reverse Recovery Charge		--	500	--	nc

Notes 1.The maximum current rating is package limited.

Notes 2.Repetitive Rating: Pulse width limited by maximum junction temperature

Notes 3.EAS condition: TJ=25°C

Typ. output characteristics

$$I_D = f(V_{DS})$$

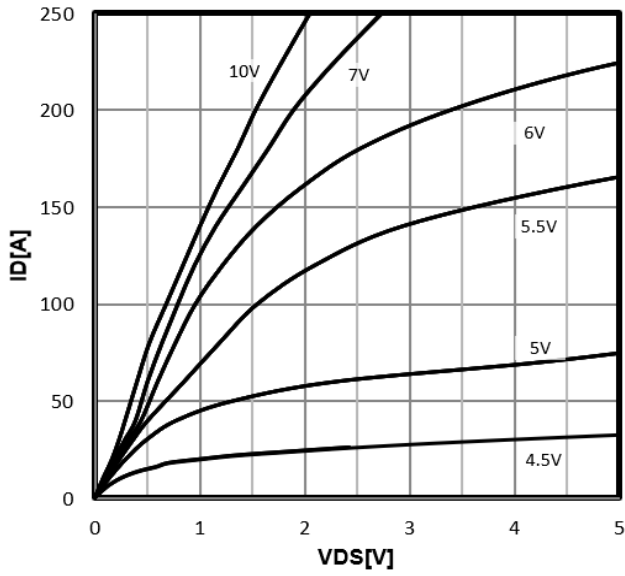
Typ. drain-source on resistance

$$R_{DS(on)} = f(I_D)$$

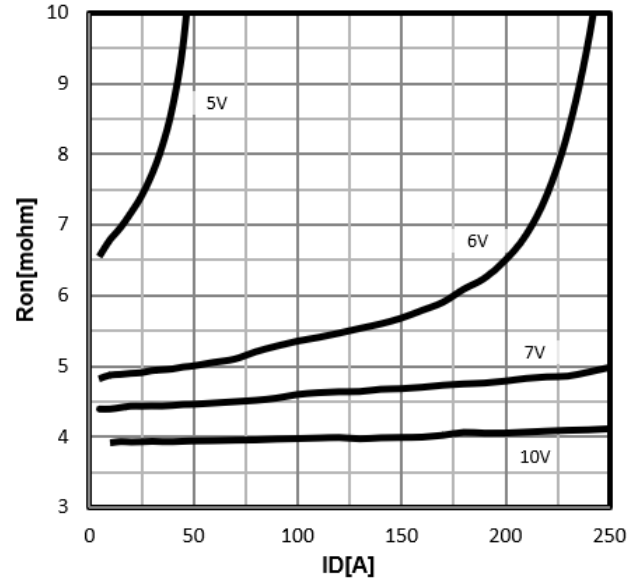
Typ. transfer characteristics

$$I_D = f(V_{GS})$$

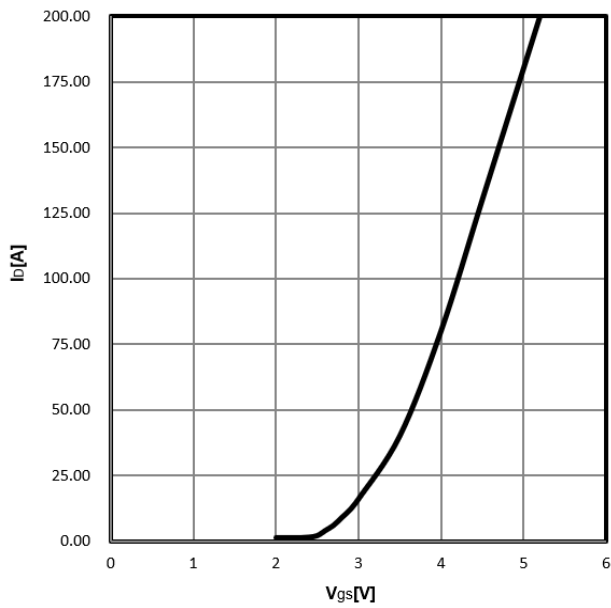

Typ. forward transconductance

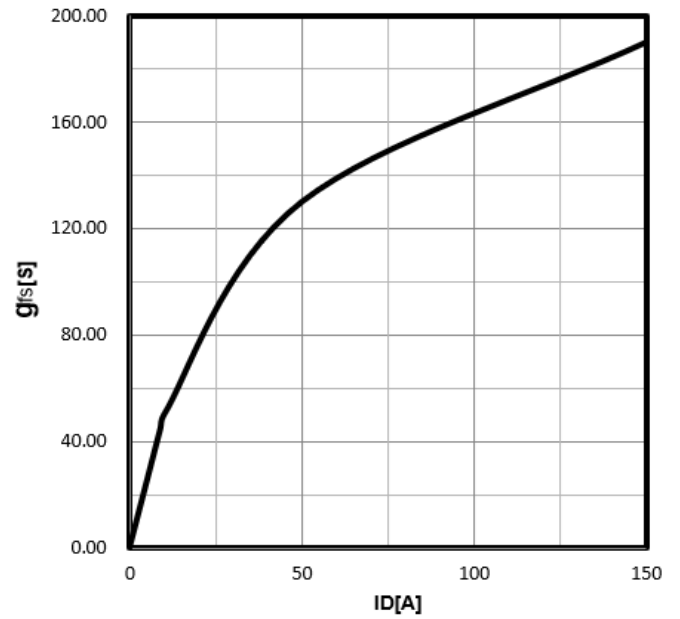
$$g_{fs} = f(I_D)$$

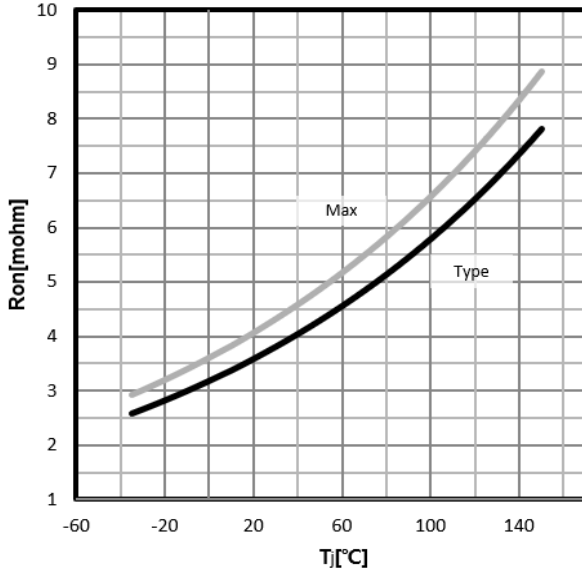

Drain-source on-state resistance

$$R_{DS(on)} = f(T_j); I_D = 80A; V_{GS} = 10V$$

Typ. capacitances

$$C = f(V_{DS}); V_{GS} = 0V; f = 1MHz$$

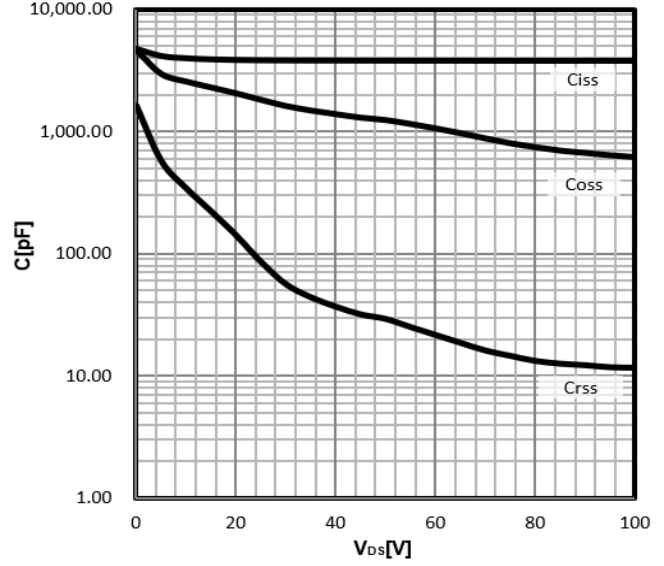
Typ. gate charge

$$V_{GS} = f(Q_{gate}); I_D = 20A$$

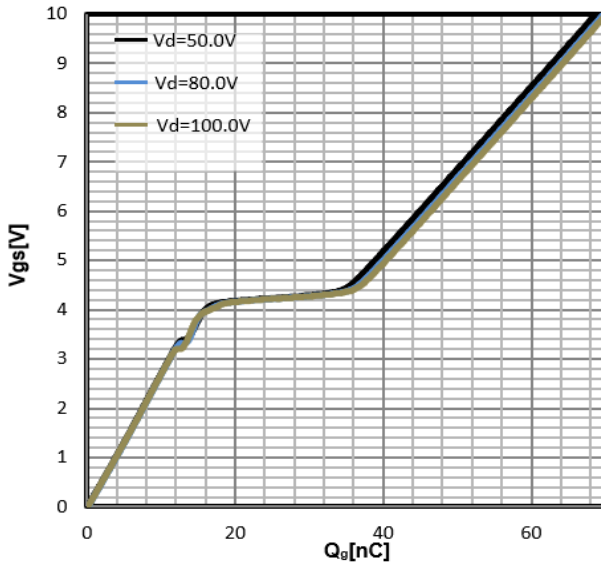

Drain-source breakdown voltage

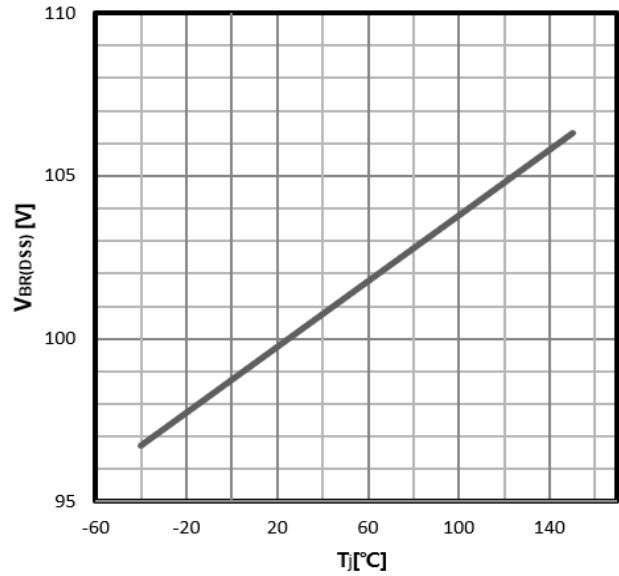
$$V_{BR(DSS)} = f(T_j); I_D = 250\mu A$$

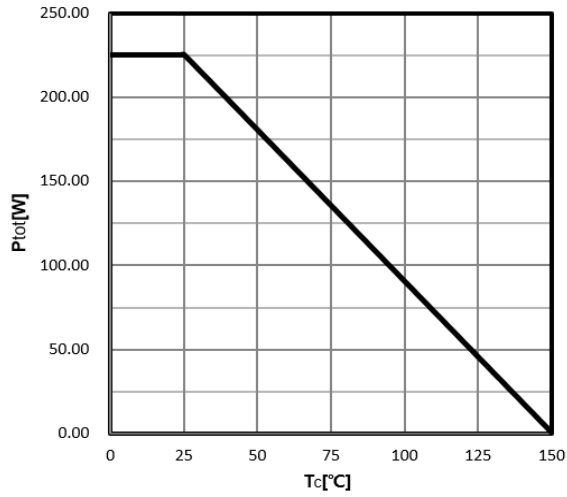

Power Dissipation

$$P_{tot}=f(T_c)$$

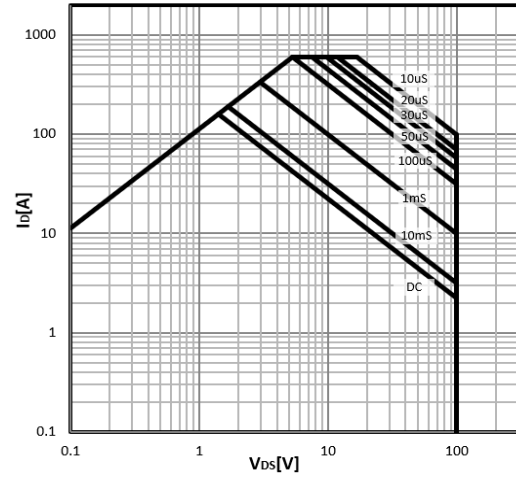

Safe operating area

$$I_D=f(V_{DS})$$

Max. transient thermal impedance

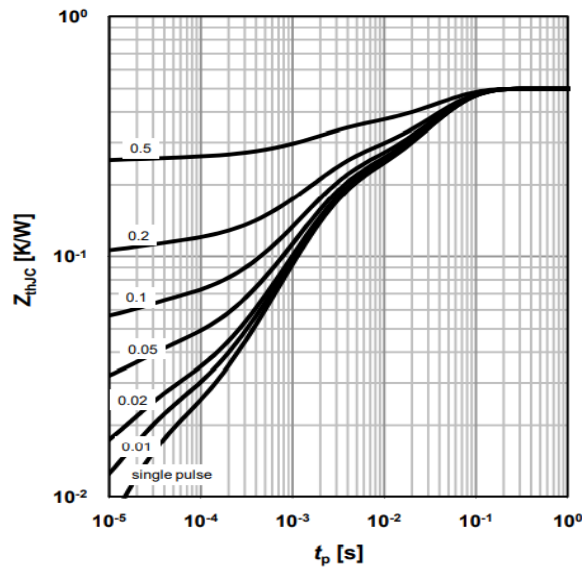
$$Z_{thJC}=f(t_p)$$

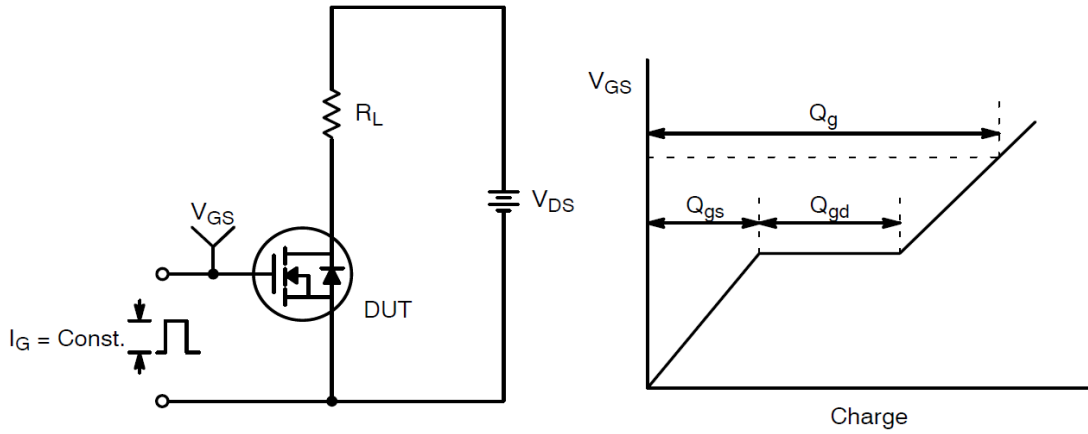
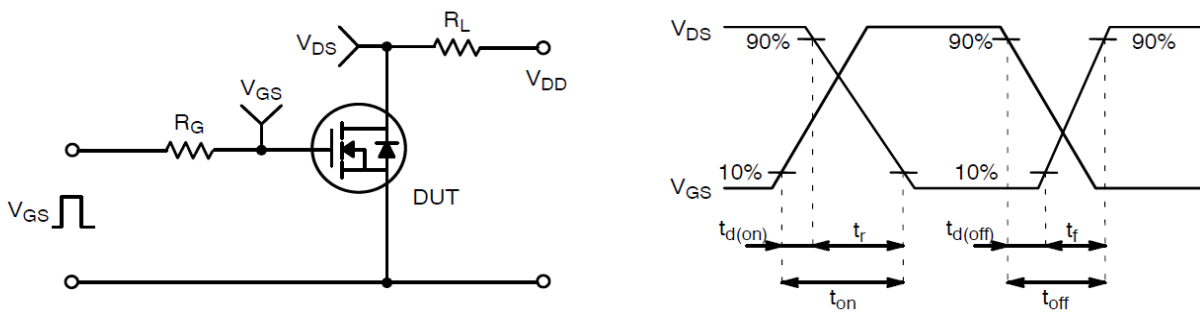
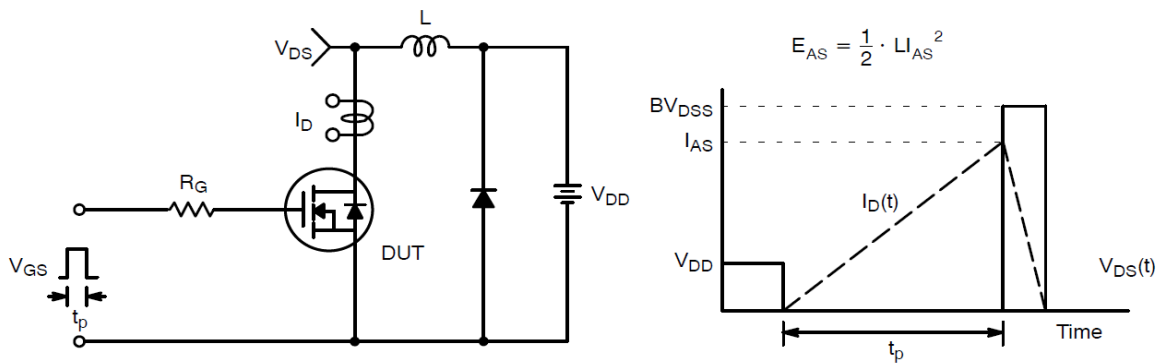

Test Circuit and Waveform:

Gate Charge Test Circuit & Waveform

Resistive Switching Test Circuit & Waveforms

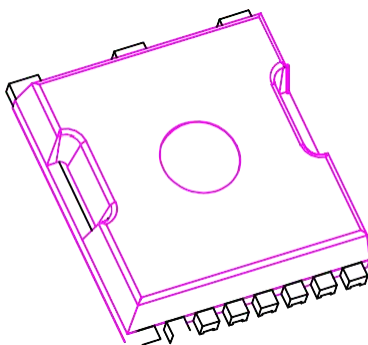
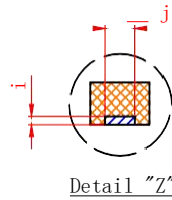
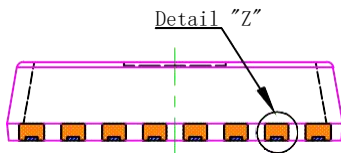
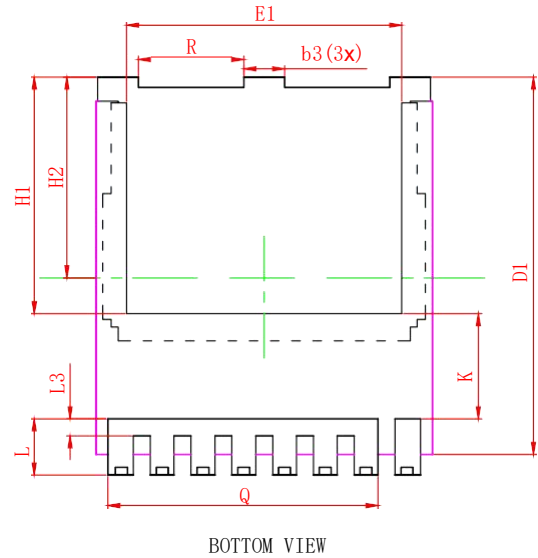
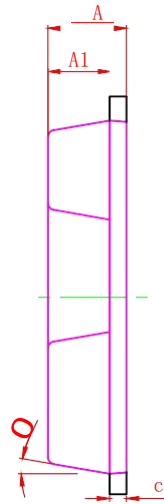
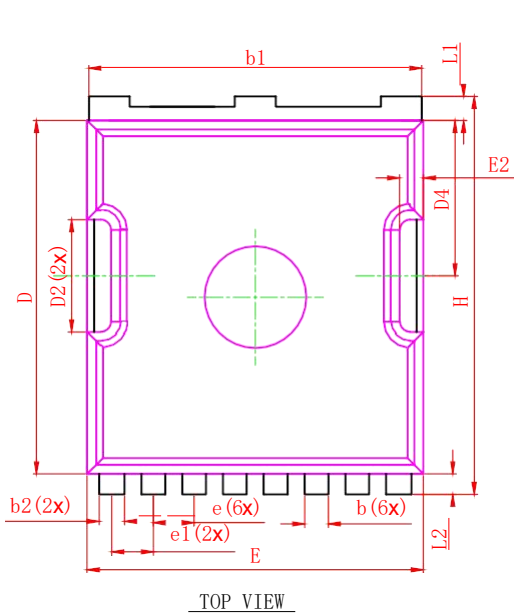
Unclamped Inductive Switching Test Circuit & Waveforms

Package Dimensions

TOLL-8L Package



SYMBOL	MILLIMETER		
	MIN.	NOM.	MAX.
A	2.200	2.300	2.400
A1	1.700	1.800	1.900
b	0.600	0.700	0.800
b1	9.700	9.800	9.900
b2	0.650	0.750	0.850
b3	1.100	1.200	1.300
c	0.400	0.500	0.600
D	10.300	10.400	10.500
D1	11.000	11.100	11.200
D2	3.200	3.300	3.400
D4	4.470	4.570	4.670
E	9.800	9.900	10.000
E1	8.000	8.100	8.200
E2	0.500	0.600	0.700
e	1.200 BSC		
e1	1.225 BSC		
H	11.600	11.700	11.800
H1	6.950 BSC		
H2	5.900 BSC		
i	0.100 REF.		
j	0.350 REF.		
K	3.100 REF.		
L	1.550	1.650	1.750
L1	0.600	0.700	0.800
L2	0.500	0.600	0.700
L3	0.400	0.500	0.600
Q	7.950 REF.		
R	3.000	3.100	3.200
Ø	10°REE.		

Disclaimer:

The information provided in this document is believed to be accurate and reliable. however, Shenzhen Core Control Electronics Technology Co., Ltd. does not assume any responsibility for the following consequences Do not consider the use of such information or use beyond its scope.

The information mentioned in this document may be changed at any time without notice.

The products and information provided in this document do not infringe patents. Shenzhen Core Control Electronics Technology Co., Ltd. assumes no responsibility for any infringement of any other rights of third parties. The result of using such products and information.

This document is the second version issued on June 10, 2022. This document replaces and Replace all previously provided information.

 It is a registered trademark of Shenzhen Core Control Electronics Technology Co., Ltd.

Copyright © 2017 Shenzhen Core Control Electronics Technology Co., Ltd. all rights reserved.