



CRYSTAL RESONATOR SPECIFICATIONS

石英晶体谐振器承认书

客户 Customer:	立创商城
型号 Product:	3TO4
客户料号 Code No:	C2986071
我司料号 Code No:	3TO424000CWBD
频率 Frequency:	24.000MHz
数量 Sample Quantity:	
日期 Date:	2022-3-28

深圳市晶友嘉电子有限公司

SHENZHEN JINGYOUJIA ELECTRONIC CO., LTD
深圳市龙华区东环二路数字颖博智能园 B 栋 4 楼

TEL: 86-755-32840201 32850080

FAX: 86-755-84269460

供应商确认栏:

制作 Handler	确认 Checked	核审 Approved
戴晓嘉	陈斌	李晨

客户承认栏:

承认 Checked	核审 Approved



1. Electrical Parameters

No.	Parameters	Symbol	Condition	Electrical Specification			
				Min.	Type	Max.	Units
1	Nominal Frequency	-		24.000			MHz
2	Operating Temperature	Topr		-40	-	85	°C
3	Storage Temperature	Tstg		-55	-	105	°C
4	Frequency Stability	-	Note 1	±20			ppm
5	Supply Voltage	VDD		1.8	-	3.3	V
6	Current Consumption	Icc				20	mA
7	Output Type	-		CMOS			
8	Output Load	CL		15			pF
9	Output Voltage High	VoH		90%VDD	-	-	V
10	Output Voltage Low	VoL		-	-	10%VD	V
11	Rise Time	Tr	10%→90%VDD Level	-	-	8	nS
12	Fall Time	Tf	90%→10%VDD Level	-	-	8	nS
13	Symmetry or Duty Cycle	TH/T		40	50	60	%
14	Start-up Time	Tosc		-	-	10	mS
15	Enable Voltage High (Logic 1)	Vh	Note 2	70%VDD	-	-	V
16	Disable Voltage Low (Logic 0)	Vlo	Note 2	-	-	30%VD D	V
17	Aging	-	1st.Year at 25°C	±3			ppm
18	Output Disable Time	T off		-	-	150	μS
19	Output Enable Time	T on		-	-	150	μS

■ TESTING CIRCUIT

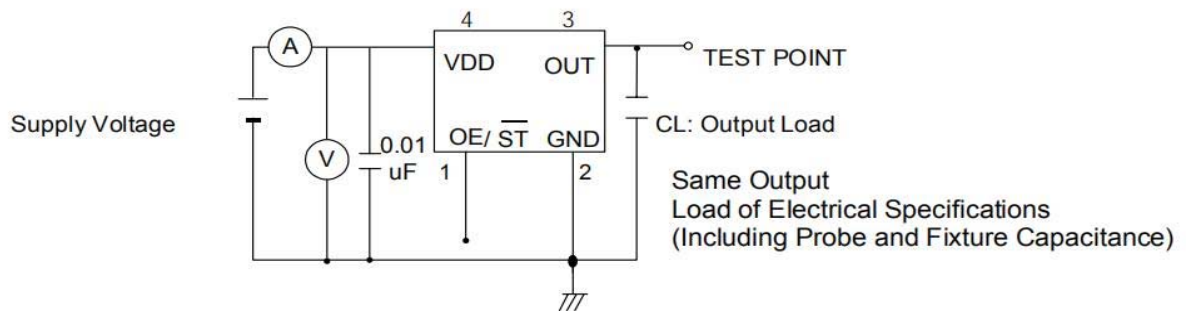

3.实物 Product

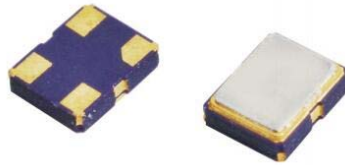

4.外型尺寸 Outline Dimensions (unit:mm)

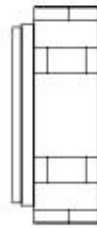
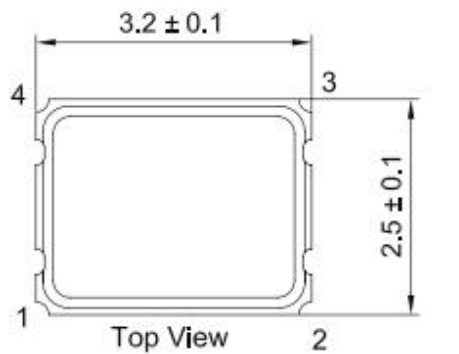

PAD FUNCTION:
1: ENABLE CONTROL
2: GND
3: OUT
4: VDD

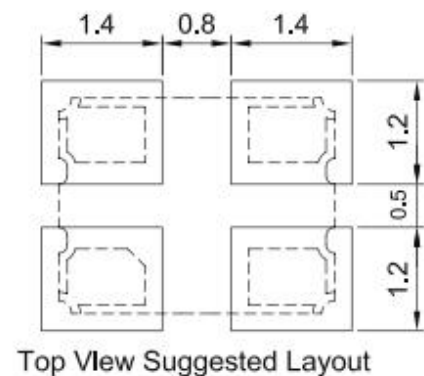
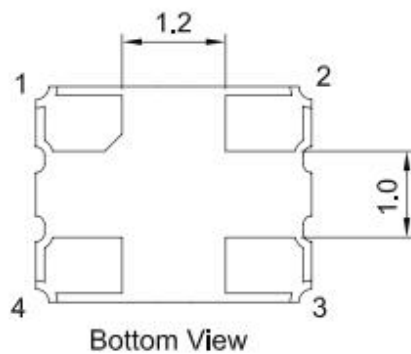
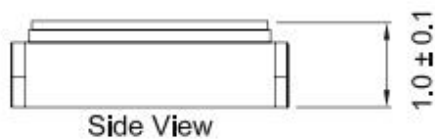

5. 波型条件 WAVEFORM CONDITIONS

Waveform measurement system should have a min. bandwidth of 5 times the frequency being tested.

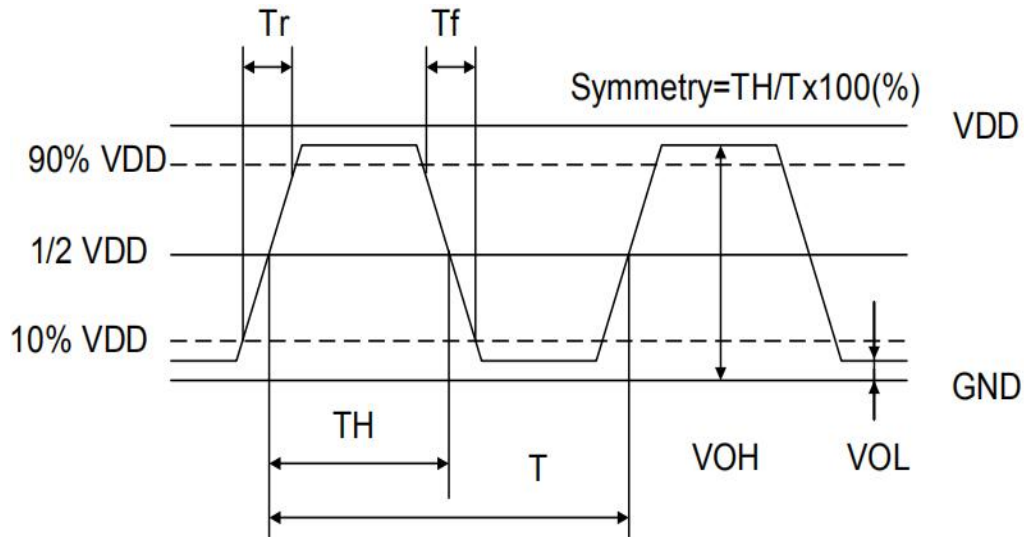

6. 回流焊曲线 Reflow Profiles

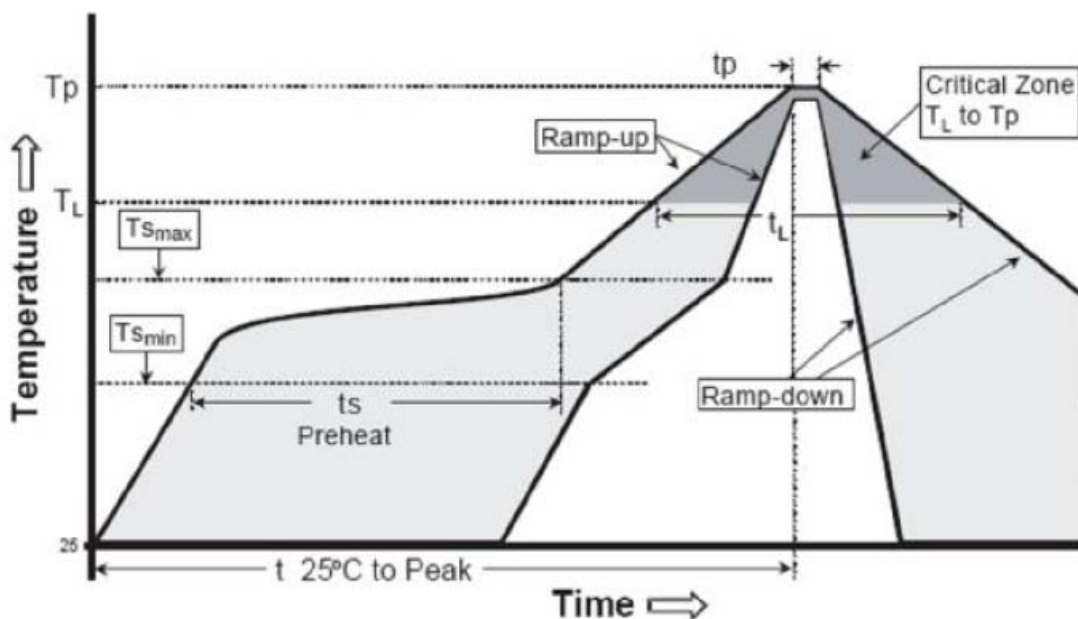



7.机械可靠/信赖性 Mechanical Performance

	Item	Condition	Standard
1.	Drop characteristics	Free drop from 50cm height on a hard wooden board for 3 times. (Board is thickness more than 30 mm.)	Frequency change: ≤5ppm Rr as specification
2..	Shake characteristics	Shake frequency 10~55Hz, cyc1~2 minutes, swing 1.5mm, direction x/y/z, all 30 minutes, test after 1 hours.	Frequency change: ≤5ppm Rr as specification
3.	Airproof characteristics	Put crystal into the pressure cabin with alcohol, keep pressure 0.4~0.5mpa 10 minutes, then take out and blow for 5 minutes	IR≥500MΩ
4.	Weld characteristics	260℃ Max, 10 seconds	90% exhibit tin ok
5.	Humidity characteristics	+40±2℃ & 90%~95% R.H. 250 hours	Frequency change: ≤5ppm Rr as specification
6.	Low temperature characteristics	-30±2℃, 250 hours, put in room temperature, test after 1 hours.	Frequency change: ≤5ppm Rr as specification
7.	High temperature characteristics	+85±2℃, 250 hours, put in room temperature, test after 1 hours.	Frequency change: ≤5ppm Rr as specification
8.	Temperature cycling	-30±3℃/30±3 min~+85±2℃/30±3min, 5 cycles	Frequency change: ≤5ppm Rr as specification

	7050	6035	5032	3225
A	5.4 ^{±0.1}	3.9 ^{±0.1}	3.5 ^{±0.1}	2.9 ^{±0.1}
B	7.4 ^{±0.1}	6.4 ^{±0.1}	5.4 ^{±0.1}	3.6 ^{±0.1}
C	16.0 ^{±0.2}	16.0 ^{±0.2}	12.0 ^{±0.2}	10.0 ^{±0.2}
D	7.5 ^{±0.1}	7.5 ^{±0.1}	5.5 ^{±0.1}	5.5 ^{±0.1}
E	1.75 ^{±0.1}	1.75 ^{±0.1}	1.75 ^{±0.1}	1.75 ^{±0.1}
F	8.0 ^{±0.1}	8.0 ^{±0.1}	8.0 ^{±0.1}	4.0 ^{±0.1}
G	2.0 ^{±0.1}	2.0 ^{±0.1}	2.0 ^{±0.1}	2.0 ^{±0.1}
H	4.0 ^{±0.1}	4.0 ^{±0.1}	4.0 ^{±0.1}	4.0 ^{±0.1}
J	1.55 ^{±0.05}	1.55 ^{±0.05}	1.5 ^{±0.1/0}	1.5 ^{±0.1/0}
K	1.4 ^{±0.1}	1.5 ^{±0.1}	1.0 ^{±0.1}	0.9 ^{±0.1}
Q	1.6 ^{±0.1/0}	1.55 ^{±0.05}	1.6 ^{±0.1}	1.5 ^{±0.1/0}
T	0.3 ^{±0.05}	0.3 ^{±0.05}	0.25 ^{±0.05}	0.25 ^{±0.05s}

9. Inner carton

