

Surface Mount Schottky Barrier Diodes

Features

- Low Forward Voltage

PINNING

PIN	DESCRIPTION
1	Cathode
2	Anode

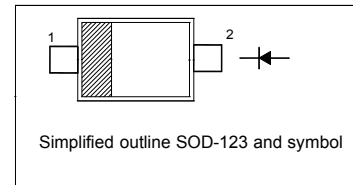

Absolute Maximum Ratings ($T_a = 25\text{ }^\circ\text{C}$)

Parameter	Symbol	Value	Unit
Peak Repetitive Reverse Voltage	V_{RRM}	40	V
Reverse Voltage	V_R	40	V
Average Forward Rectified Current	$I_{F(AV)}$	350	mA
Non-Repetitive Peak Forward Surge Current at $t = 1\text{ s}$	I_{FSM}	2	A
Power Dissipation	P_{tot}	400	mW
Operating and Storage Temperature Range	T_j, T_{stg}	- 65 to + 125	$^\circ\text{C}$

Characteristics at $T_a = 25\text{ }^\circ\text{C}$

Parameter	Symbol	Min.	Typ.	Max.	Unit
Reverse Breakdown Voltage at $I_R = 10\text{ }\mu\text{A}$	$V_{(BR)R}$	40	-	-	V
Reverse Leakage Current at $V_R = 30\text{ V}$	I_R	-	-	5	μA
Forward Voltage at $I_F = 20\text{ mA}$ at $I_F = 200\text{ mA}$	V_F	- -	- -	0.37 0.6	V
Total Capacitance at $V_R = 0\text{ V}$, $f = 1\text{ MHz}$	C_T	-	50	-	pF
Reverse Recovery Time at $I_F = I_R = 200\text{ mA}$, $I_{tr} = 0.1 I_R$, $R_L = 100\text{ }\Omega$	t_{rr}	-	10	-	ns

TYPICAL CHARACTERISTICS

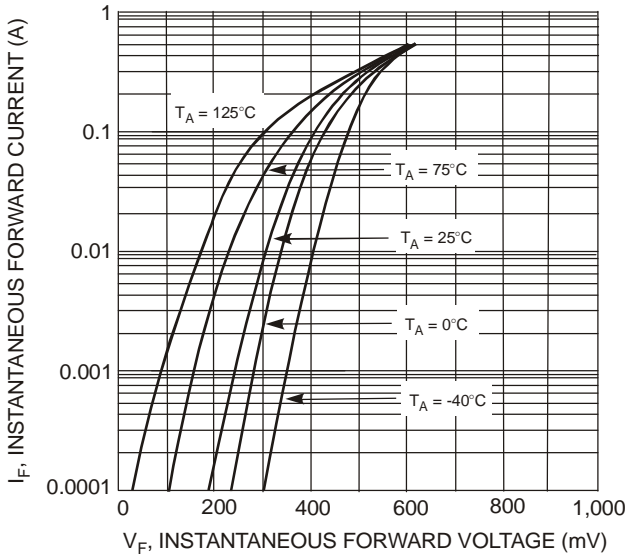

Fig. 1 Typical Forward Characteristics

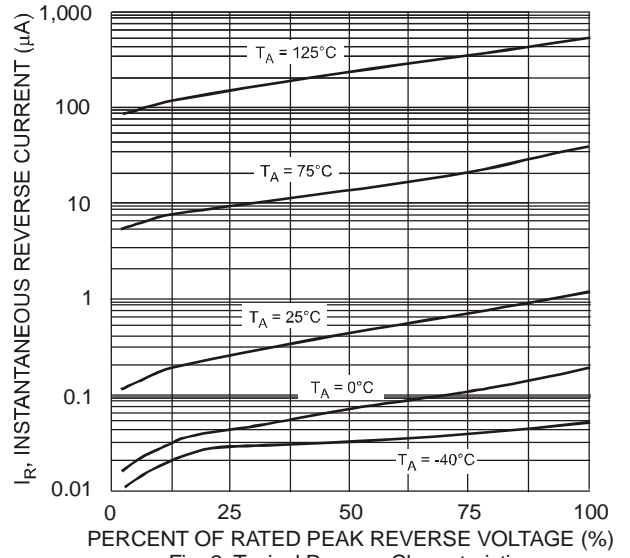

Fig. 2 Typical Reverse Characteristics

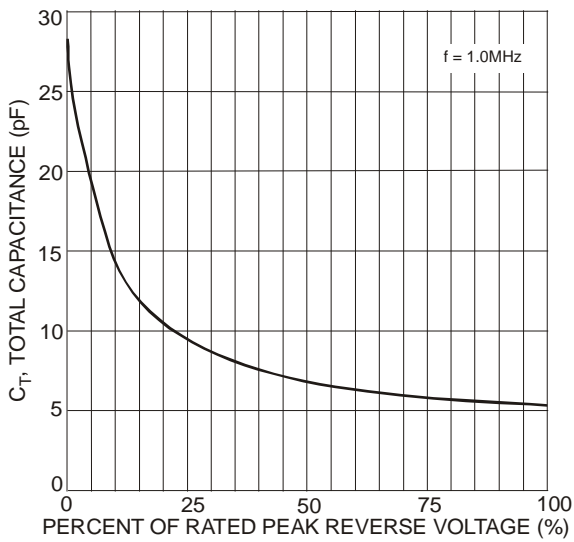

Fig. 3 Total Capacitance vs. Reverse Voltage

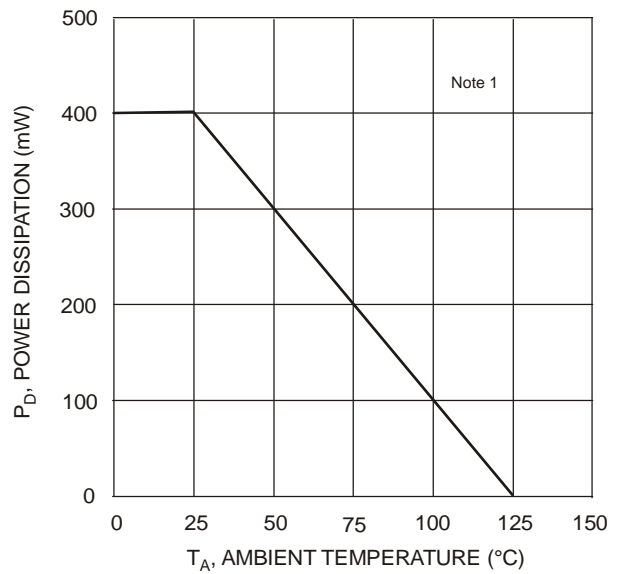
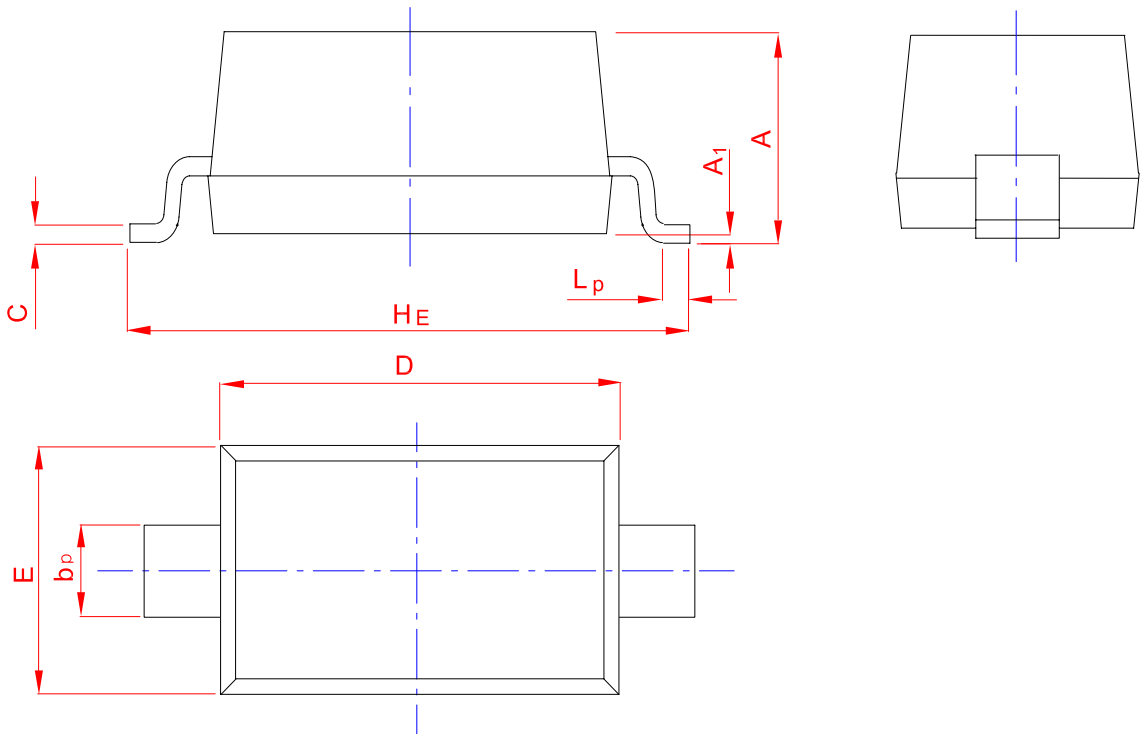
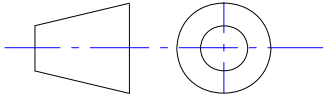

Fig. 4 Power Derating Curve

PACKAGE OUTLINE

Plastic surface mounted package; 2 leads

SOD-123



UNIT	A	bp	C	D	E	HE	A1	Lp
mm	1.20	0.60	0.135	2.75	1.65	3.85	0.10	0.50
	0.90	0.50	0.100	2.55	1.55	3.55	0.01	0.20