

Automotive-grade N-channel 75 V, 18 mΩ, 40 A, STripFET™ II Power MOSFET in a DPAK package

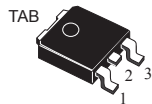

DPAK

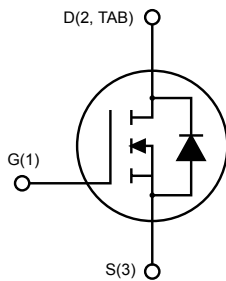

AM01475v1_noZen

Features

Type	V _{DS}	R _{DS(on)} max.	I _D
STD45NF75T4	75 V	24 mΩ	40 A

- AEC-Q101 qualified 
- Exceptional dv/dt capability
- 100% avalanche tested
- Low gate charge

Applications

- Switching applications

Description

This Power MOSFET series has been developed using STMicroelectronics' unique STripFET™ process, which is specifically designed to minimize input capacitance and gate charge. This renders the device suitable for use as primary switch in advanced high-efficiency isolated DC-DC converters for telecom and computer applications, and applications with low gate charge driving requirements.

Product status link

[STD45NF75T4](#)

Product summary

Order code	STD45NF75T4
Marking	D45NF75
Package	DPAK
Packing	Tape and reel

1 Electrical ratings

Table 1. Absolute maximum ratings

Symbol	Parameter	Value	Unit
V_{DS}	Drain-source voltage	75	V
V_{GS}	Gate-source voltage	± 20	V
I_D	Drain current (continuous) at $T_C = 25\text{ }^\circ\text{C}$	40 ⁽¹⁾	A
	Drain current (continuous) at $T_C = 100\text{ }^\circ\text{C}$	30	A
$I_{DM}^{(2)}$	Drain current (pulsed)	160	A
P_{TOT}	Total dissipation at $T_C = 25\text{ }^\circ\text{C}$	125	W
$E_{AS}^{(3)}$	Single-pulse avalanche energy	500	mJ
$dv/dt^{(4)}$	Peak diode recovery voltage slope	20	V/ns
T_{stg}	Storage temperature range	-55 to 175	$^\circ\text{C}$
T_J	Operating junction temperature range		

1. This value is limited by package.
2. Pulse width is limited by safe operating area.
3. Starting $T_J = 25\text{ }^\circ\text{C}$, $I_D = 20\text{ A}$, $V_{DD} = 40\text{ V}$
4. $I_{SD} \leq 40\text{ A}$, $di/dt \leq 800\text{ A}/\mu\text{s}$, $V_{DD} \leq V_{(BR)DSS}$, $T_J \leq T_{JMAX}$

Table 2. Thermal data

Symbol	Parameter	Value	Unit
$R_{thj-case}$	Thermal resistance junction-case	1.2	$^\circ\text{C}/\text{W}$
$R_{thj-pcb}$	Thermal resistance junction-pcb ⁽¹⁾	50	$^\circ\text{C}/\text{W}$

1. When mounted on an 1-inch² FR-4, 2 Oz copper board.

2 Electrical characteristics

$T_{CASE} = 25\text{ °C}$ unless otherwise specified

Table 3. On/off states

Symbol	Parameter	Test conditions	Min.	Typ.	Max.	Unit
$V_{(BR)DSS}$	Drain-source breakdown voltage	$V_{GS} = 0\text{ V}$, $I_D = 250\text{ }\mu\text{A}$	75			V
I_{DSS}	Zero gate voltage drain current	$V_{GS} = 0\text{ V}$, $V_{DS} = 75\text{ V}$			1	μA
		$V_{GS} = 0\text{ V}$, $V_{DS} = 75\text{ V}$, $T_C = 125\text{ °C}^{(1)}$			10	μA
I_{GSS}	Gate body leakage current	$V_{DS} = 0\text{ V}$, $V_{GS} = \pm 20\text{ V}$			± 100	nA
$V_{GS(th)}$	Gate threshold voltage	$V_{DD} = V_{GS}$, $I_D = 250\text{ }\mu\text{A}$	2		4	V
$R_{DS(on)}$	Static drain-source on-resistance	$V_{GS} = 10\text{ V}$, $I_D = 20\text{ A}$		18	24	m Ω

1. Defined by design, not subject to production test.

Table 4. Dynamic

Symbol	Parameter	Test conditions	Min.	Typ.	Max.	Unit
C_{iss}	Input capacitance	$V_{DS} = 25\text{ V}$, $f = 1\text{ MHz}$, $V_{GS} = 0\text{ V}$	-	1760	-	pF
C_{oss}	Output capacitance		-	360	-	pF
C_{rss}	Reverse transfer capacitance		-	140	-	pF
Q_g	Total gate charge	$V_{DD} = 60\text{ V}$, $I_D = 40\text{ A}$, $R_G = 4.7\text{ }\Omega$, $V_{GS} = 0\text{ to }10\text{ V}$ (see Figure 13. Test circuit for gate charge behavior)	-	60	80	nC
Q_{gs}	Gate-source charge		-	13	-	nC
Q_{gd}	Gate-drain charge		-	23	-	nC

Table 5. Switching times

Symbol	Parameter	Test conditions	Min.	Typ.	Max.	Unit
$t_{d(on)}$	Turn-on delay time	$V_{DD} = 37\text{ V}$, $I_D = 20\text{ A}$, $R_G = 4.7\text{ }\Omega$, $V_{GS} = 10\text{ V}$	-	15	-	ns
t_r	Rise time		-	40	-	ns
$t_{d(off)}$	Turn-off delay time	(see Figure 12. Test circuit for resistive load switching times and Figure 17. Switching time waveform)	-	55	-	ns
t_f	Fall time		-	10	-	ns

Table 6. Source-drain diode

Symbol	Parameter	Test conditions	Min.	Typ.	Max.	Unit
I_{SD}	Source-drain current		-		40	A
$I_{SDM}^{(1)}$	Source-drain current (pulsed)		-		160	A
$V_{SD}^{(2)}$	Forward on voltage	$I_{SD} = 40\text{ A}$, $V_{GS} = 0\text{ V}$	-		1.5	V
t_{rr}	Reverse recovery time	$I_{SD} = 40\text{ A}$, $di/dt = 100\text{ A}/\mu\text{s}$,	-	120		ns
Q_{rr}	Reverse recovery charge	$V_{DD} = 30\text{ V}$, $T_J = 150\text{ }^\circ\text{C}$	-	410		nC
I_{RRM}	Reverse recovery current	(see Figure 17. Switching time waveform)	-	7.5		A

1. Pulse width limited by safe operating area
2. Pulsed: pulse duration = 300 μs , duty cycle 1.5%

2.1 Electrical characteristics (curves)

Figure 1. Safe operating area

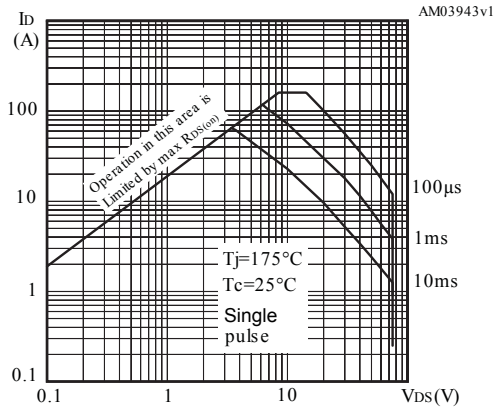

Figure 2. Thermal impedance

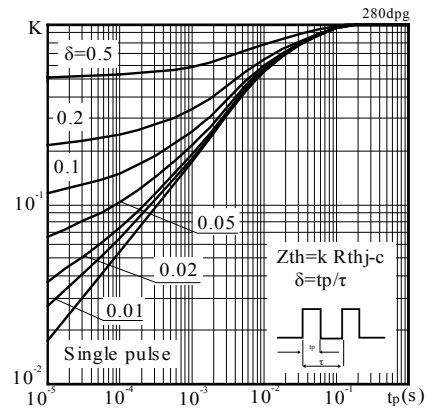

Figure 3. Output characteristics

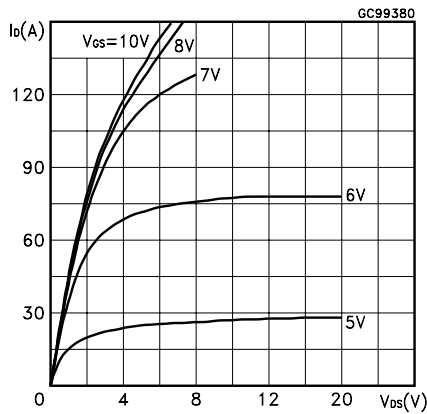

Figure 4. Transfer characteristics

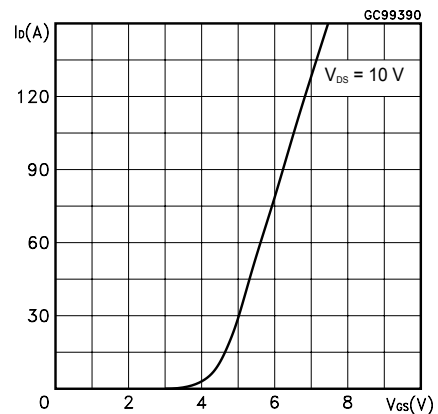

Figure 5. Static drain-source on-resistance

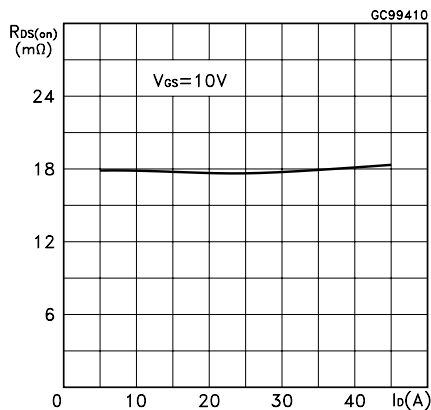

Figure 6. Gate charge vs gate-source voltage

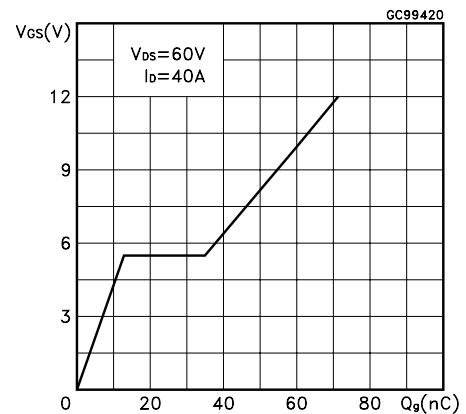

Figure 7. Capacitance variations

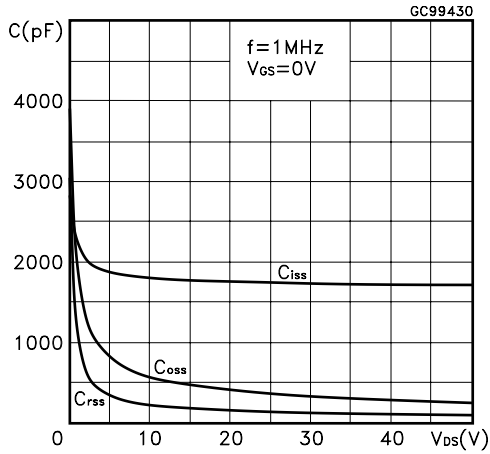

Figure 8. Normalized gate threshold voltage vs temperature

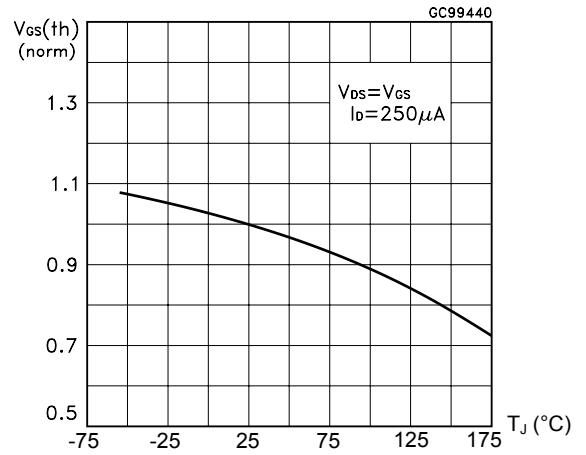

Figure 9. Normalized on-resistance vs temperature

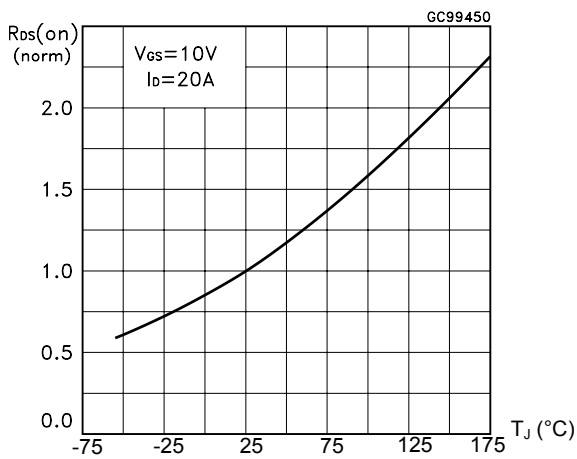

Figure 10. Source-drain diode forward characteristics

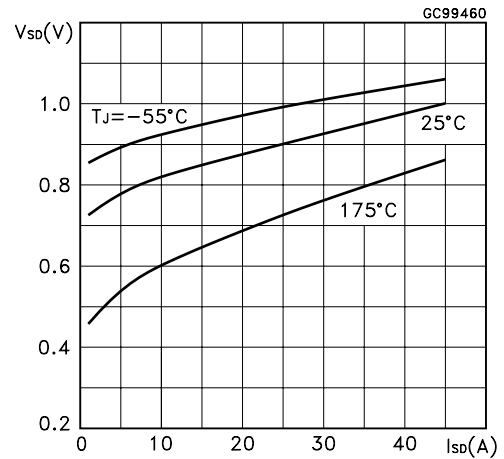
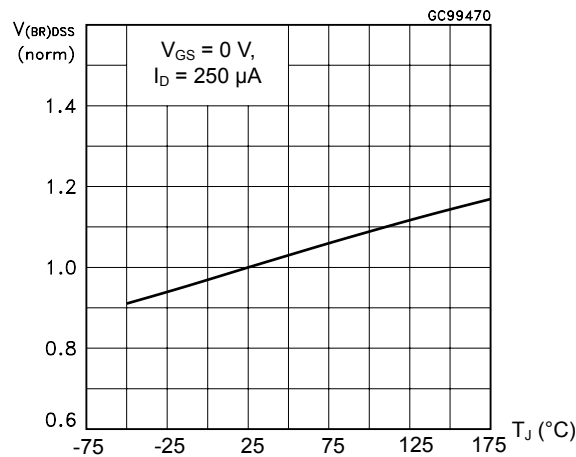
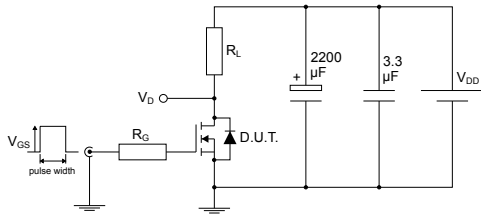

Figure 11. Normalized $V_{(BR)DSS}$ vs temperature



3 Test circuits

Figure 12. Test circuit for resistive load switching times

AM01468v1

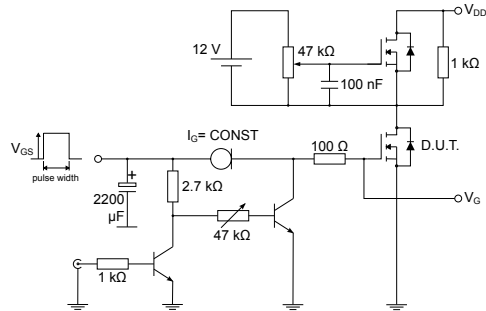
Figure 13. Test circuit for gate charge behavior

AM01469v1

Figure 14. Test circuit for inductive load switching and diode recovery times



AM01470v1

Figure 15. Unclamped inductive load test circuit

AM01471v1

Figure 16. Unclamped inductive waveform

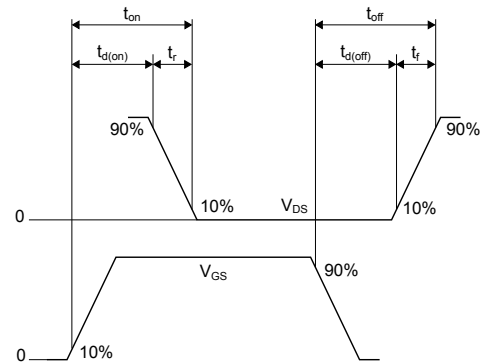
AM01472v1

Figure 17. Switching time waveform

AM01473v1

4 Package information

In order to meet environmental requirements, ST offers these devices in different grades of ECOPACK® packages, depending on their level of environmental compliance. ECOPACK® specifications, grade definitions and product status are available at: www.st.com. ECOPACK® is an ST trademark.

4.1 DPAK (TO-252) type A2 package information

Figure 18. DPAK (TO-252) type A2 package outline

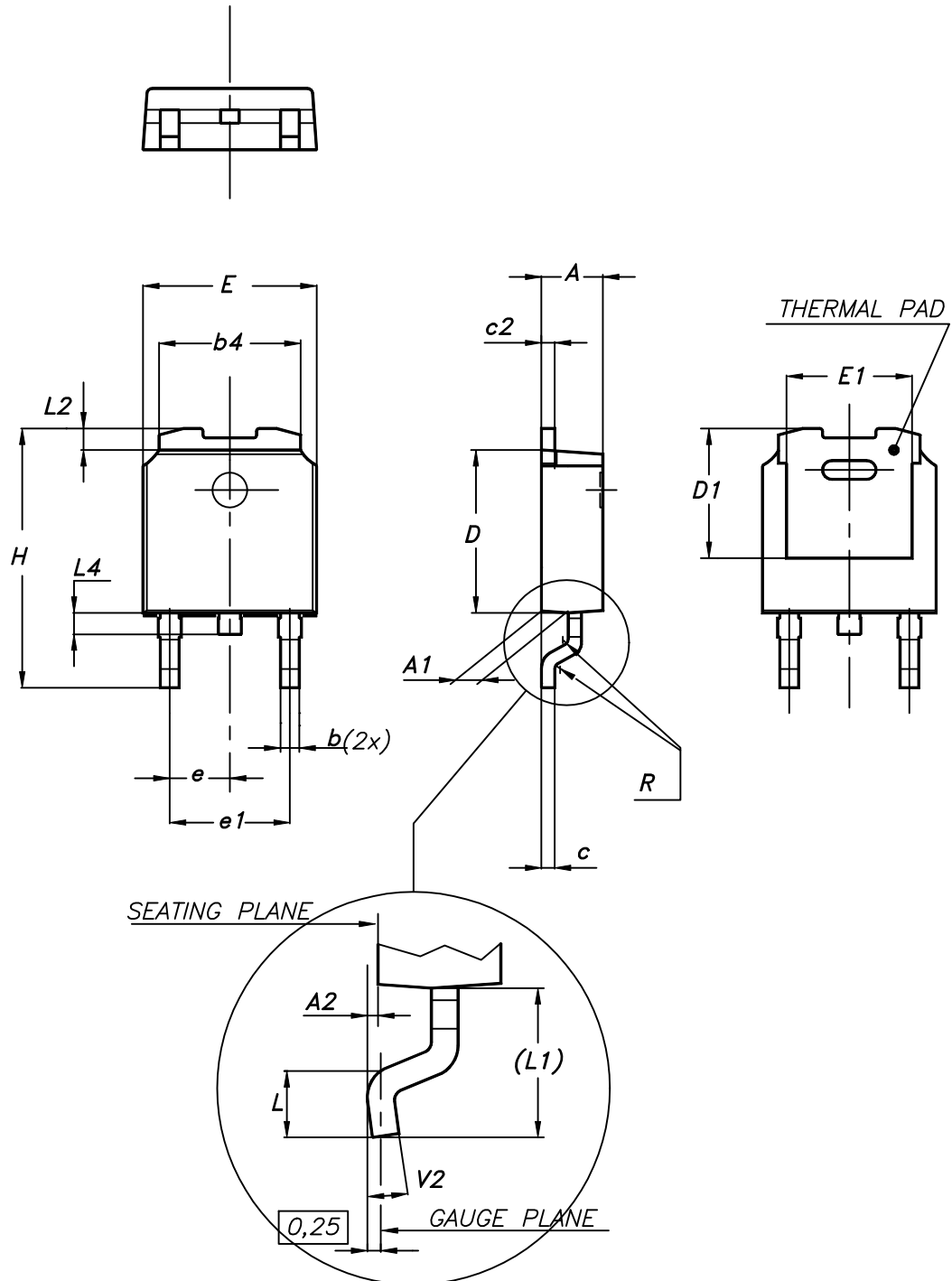

0068772_type-A2_rev25

Table 7. DPAK (TO-252) type A2 mechanical data

Dim.	mm		
	Min.	Typ.	Max.
A	2.20		2.40
A1	0.90		1.10
A2	0.03		0.23
b	0.64		0.90
b4	5.20		5.40
c	0.45		0.60
c2	0.48		0.60
D	6.00		6.20
D1	4.95	5.10	5.25
E	6.40		6.60
E1	5.10	5.20	5.30
e	2.159	2.286	2.413
e1	4.445	4.572	4.699
H	9.35		10.10
L	1.00		1.50
L1	2.60	2.80	3.00
L2	0.65	0.80	0.95
L4	0.60		1.00
R		0.20	
V2	0°		8°

Figure 19. DPAK (TO-252) recommended footprint (dimensions are in mm)

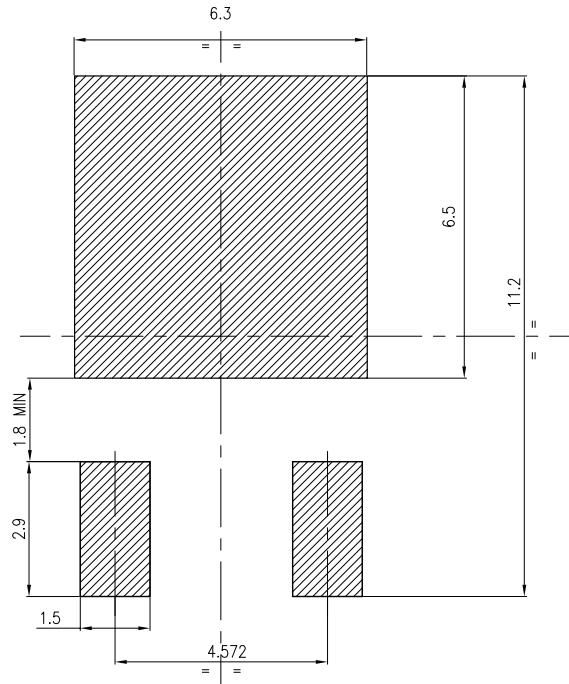

FP_0068772_25

4.2 DPAK (TO-252) packing information

Figure 20. DPAK (TO-252) tape outline

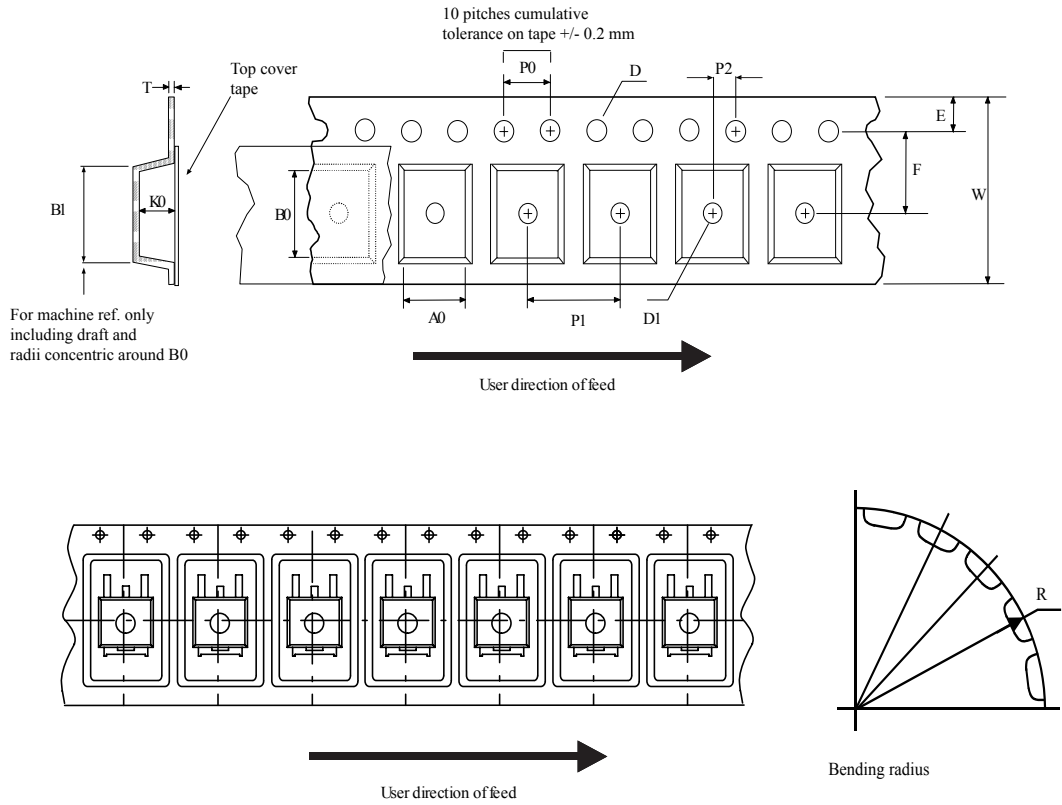

AM08852v1

Figure 21. DPAK (TO-252) reel outline

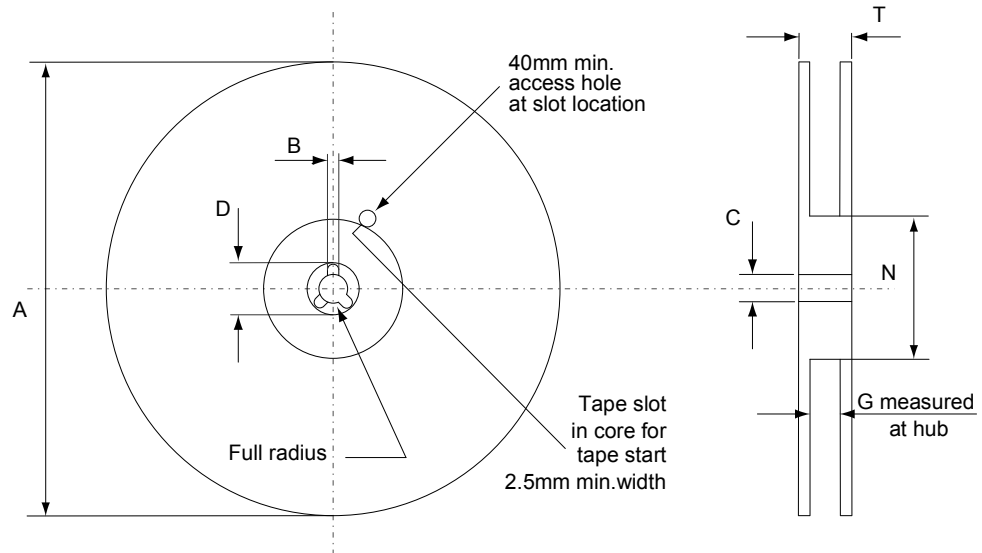

AM06038v1

Table 8. DPAK (TO-252) tape and reel mechanical data

Tape			Reel		
Dim.	mm		Dim.	mm	
	Min.	Max.		Min.	Max.
A0	6.8	7	A		330
B0	10.4	10.6	B	1.5	
B1		12.1	C	12.8	13.2
D	1.5	1.6	D	20.2	
D1	1.5		G	16.4	18.4
E	1.65	1.85	N	50	
F	7.4	7.6	T		22.4
K0	2.55	2.75			
P0	3.9	4.1	Base qty.		2500
P1	7.9	8.1	Bulk qty.		2500
P2	1.9	2.1			
R	40				
T	0.25	0.35			
W	15.7	16.3			

Revision history

Table 9. Document revision history

Date	Version	Changes
22-Jun-2004	1	Preliminary version
09-Sep-2004	2	Complete version
11-Jul-2006	3	New template, no content change
20-Feb-2007	4	Typo mistake on page 1
20-May-2009	5	<i>Figure 2</i> and <i>Figure 3</i> have been updated
03-Oct-2018	6	Updated information on cover page. Updated Section 4 Package information . Minor text changes

Contents

1	Electrical ratings	2
2	Electrical characteristics	3
2.1	Electrical characteristics (curves)	5
3	Test circuits	7
4	Package information	8
4.1	DPAK (TO-252) type A2 package information	8
4.2	DPAK (TO-252) packing information	11
	Revision history	14

IMPORTANT NOTICE – PLEASE READ CAREFULLY

STMicroelectronics NV and its subsidiaries (“ST”) reserve the right to make changes, corrections, enhancements, modifications, and improvements to ST products and/or to this document at any time without notice. Purchasers should obtain the latest relevant information on ST products before placing orders. ST products are sold pursuant to ST’s terms and conditions of sale in place at the time of order acknowledgement.

Purchasers are solely responsible for the choice, selection, and use of ST products and ST assumes no liability for application assistance or the design of Purchasers’ products.

No license, express or implied, to any intellectual property right is granted by ST herein.

Resale of ST products with provisions different from the information set forth herein shall void any warranty granted by ST for such product.

ST and the ST logo are trademarks of ST. All other product or service names are the property of their respective owners.

Information in this document supersedes and replaces information previously supplied in any prior versions of this document.

© 2018 STMicroelectronics – All rights reserved

Mouser Electronics

Authorized Distributor

Click to View Pricing, Inventory, Delivery & Lifecycle Information:

[STMicroelectronics:](#)

[STD45NF75T4](#)