

5

4

3

2

1



D

C

B

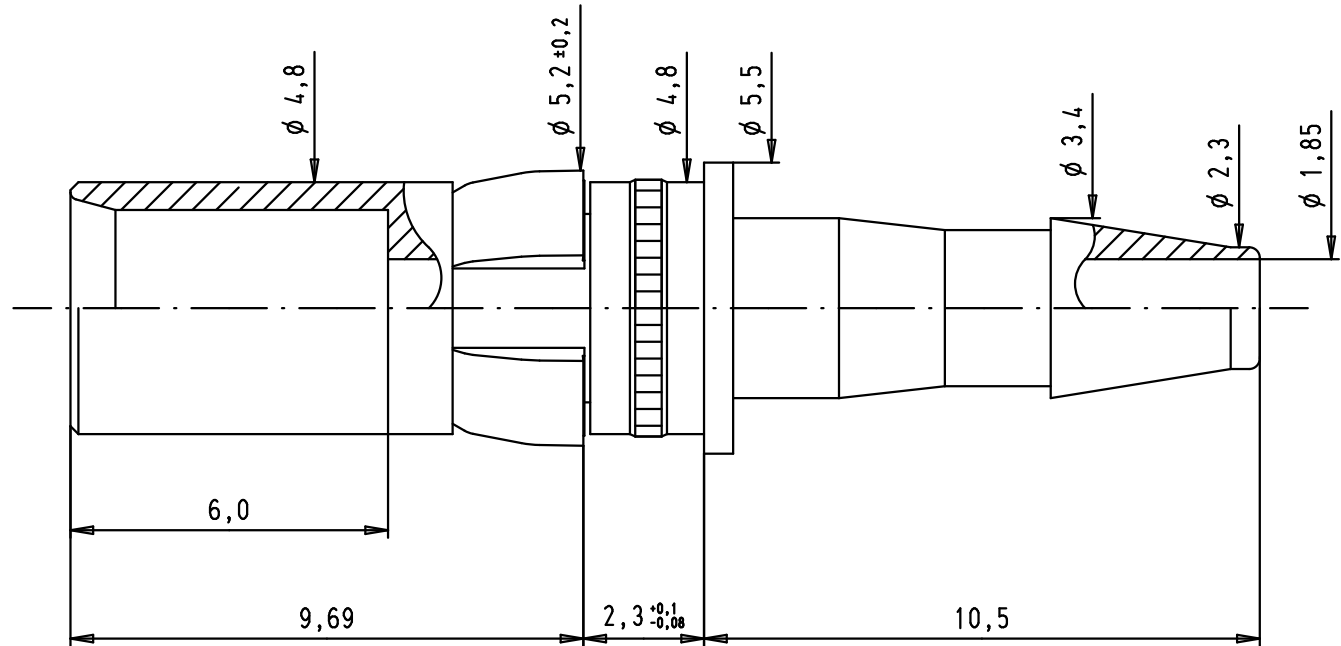
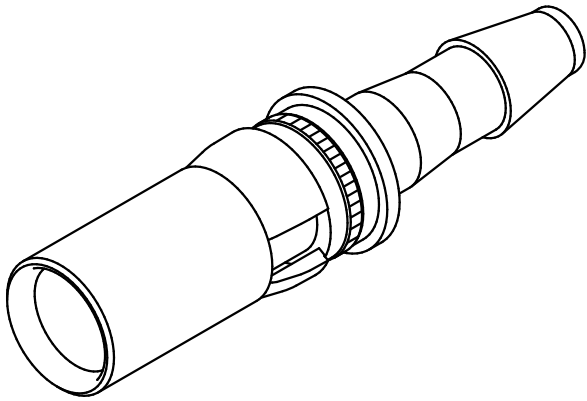
A



				Dot.	Name	 All Dim. in mm Orig. Size DIN A 4	Straight female pneumatic contact for 3 mm inner diameter compressed air tube	Moßstab/ Scale
			Detail.	25/04/07	PK			7:1
			Insp.					
			Stand.					
33985	25/04/07	PK	HARTING EURL F-95972 Paris				TB 09 69 187 0062	Blatt/ Page
Mod.	Dot.	Name					Sub.	1/1