

KEMET Part Number: HHBC10-0R8A0038V
(UALC100R8A0038)

KEMET, HHBC, AC Line Filters, Normal Mode, 38 uH, 20%

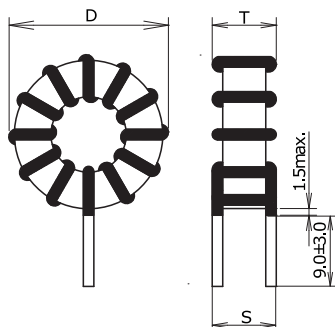

Dimensions

D	21.5mm MAX
T	11.7mm MAX
LL	9mm +/-3mm
S	8mm NOM

Packaging Specifications

Packaging:	Tray
Packaging Quantity:	240
Weight:	9 g

General Information

Series:	HHBC
Style:	Through-Hole
Features:	Noise Solution, Switching Power Supply Outlets, DC-DC Converter
RoHS:	Yes
Miscellaneous:	15 (K) Temperature Rise Max.

Specifications

Inductance:	38 uH
Inductance Tolerance:	20%
Current:	3 A
Temperature Range:	-40/+125°C
DC Resistance:	31.2 mOhms