

TEST/CHARACTERISTICS	STANDARD REFERENCE	VALUES/REMARKS		
----------------------	--------------------	----------------	--	--

### ELECTRICAL CHARACTERISTICS

Impedance		50 Ω		
Frequency range		DC-4 GHz		
Typical V.S.W.R. <i>Straight models cable group : 2/50, 2.6/50, 5/50, 10 + 11/50, .141"</i> <i>Right angle models 2/50, 2.6/50, 5/50,</i>		1 GHz 1.12	2.5 GHz 1.18 1.30 max	4 GHz 1.22
Insertion loss <i>straight connector</i> <i>right-angle connector</i>		0.05 0.08	0.07 0.16	0.13 0.20
RF Leakage		- 55 dB min from 2 to 3 GHz		
Insulation resistance		5000 MΩ min	5000 MΩ min	5000 MΩ min
Contact resistance <i>center contact</i> <i>outer contact</i>	MIL	1.5 mΩ 0.2 mΩ		
Working voltage in VRMS <i>at sea level</i> <i>(at 21 000m)</i>		500 125		
Dielectric withstanding voltage in VRMS <i>at sea level</i> <i>(at 21 000m)</i>		1500 375		
RF testing voltage in VRMS <i>sea level (5 MHz)</i>		1000		

### MECHANICAL CHARACTERISTICS

Durability		500 matings		
Force to engage and disengage <i>axial torque</i>		13.6 N max 28.6 Ncm		
Coupling nut retention force	MIL	445 N		
Cable retention force <i>cable 2/50, 2.6/50</i> <i>cable 5/50, 10 + 11/50</i> <i>cable .141"</i>		227 N		
Center contact retention force		27.2 N		

### ENVIRONMENTAL CHARACTERISTICS

Temperature range <i>flexible cables</i> <i>semi-rigid cables</i>	MIL	- 65°C + 165°C - 65°C + 105°C		
Thermo cycling test		MIL STD 202, method 107, condition B		
Thermal shock		MIL STD 202, method 107, condition B		
Hight temperature endurance		MIL STD 202, method 108		
Corrosion salt spray		MIL STD 202, method 101, condition B		
Vibration		MIL STD 202, method 204, condition B		
Shock		MIL STD 202, method 213, condition G		
Moisture resistance		MIL STD 202, method 106		
Hermetic test		MIL STD 202, method 112, condition C vacuum 10 <sup>-6</sup> Hgmm (Torr) leakage rate < 10 <sup>-6</sup> atm/cm <sup>3</sup> /s		
Barometric pressure		Pressure test : 3.5 bars; duration : 2 mn; temperature : 15° C to 25 °C		

# BNC 50 Ω

## CHARACTERISTICS

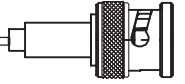

### MATERIALS

Bodies		Brass
Center contact	<i>male</i> <i>female</i>	Brass Bronze or heat treated beryllium following QQ-C-530
Nut		Brass
Insulator		PTFE
Gasket		Silicon rubber

### PLATINGS

Bodies		Nickel
Center contacts		Gold

### POWER RATING

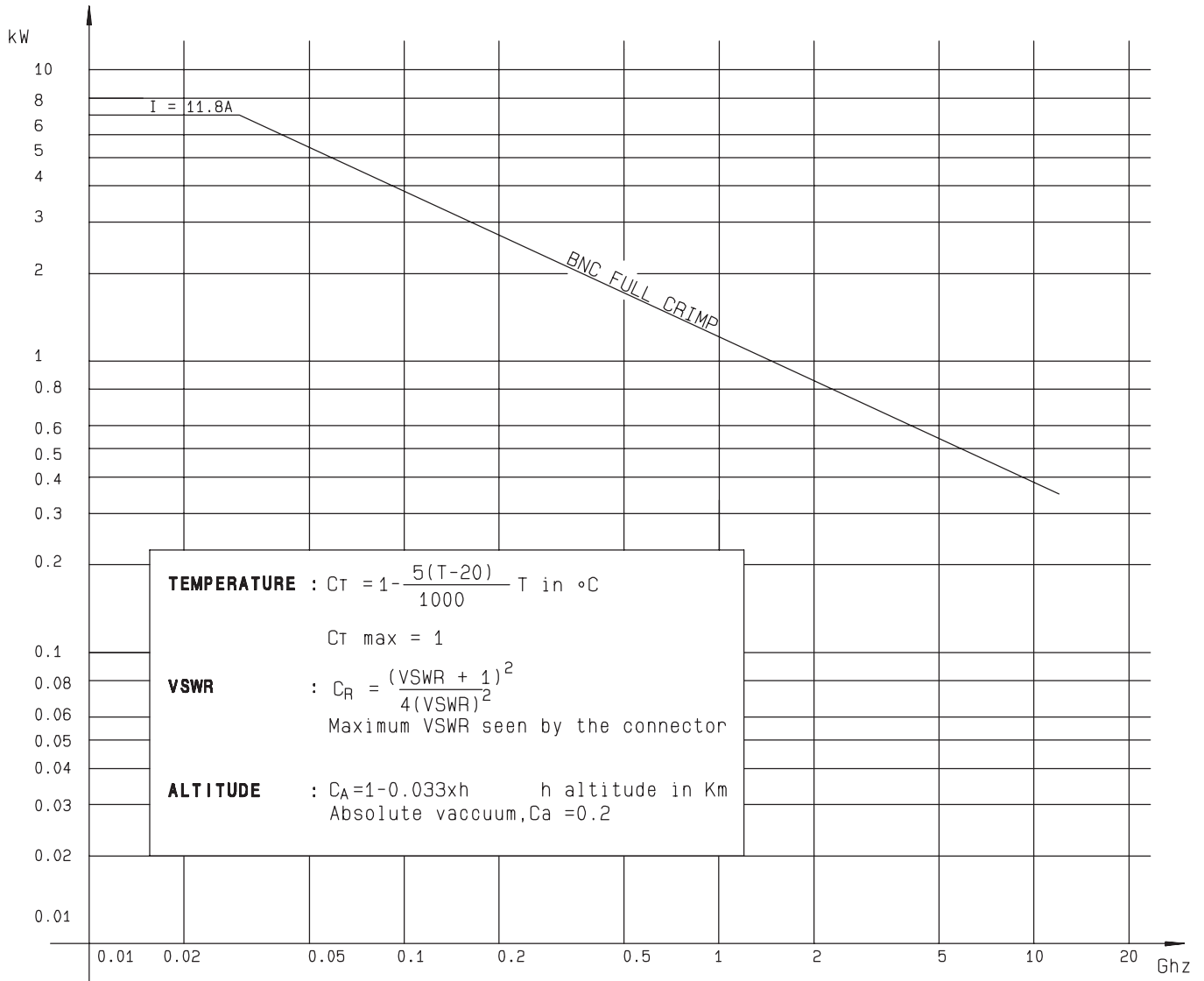

Standard packaging : unit

All dimensions are given in mm.

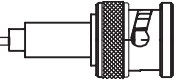

### RIGHT ANGLE PLUGS CLAMP TYPE FOR FLEXIBLE CABLES

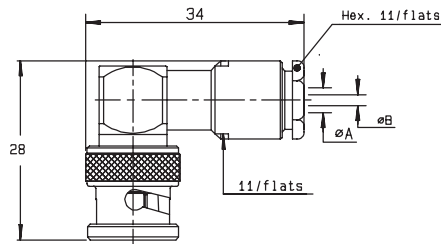
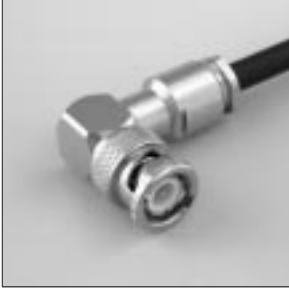

Fig. 1

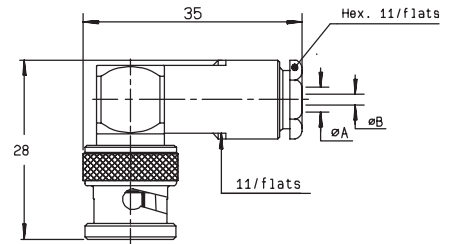
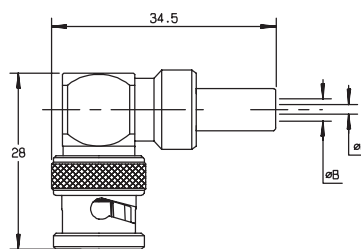

Fig. 2

cable	part number	fig.	dimensions		captive center contact	assembly
			A	B		
2 / 50/ S + D	R141 153 000	1	2.2	0.6	yes	M02
2.6 / 50/ S + D	R141 154 000	1	3.1	0.6	yes	M02
5 / 50/ S + D	R141 156 000	2	5.6	1.05	yes	M01

### RIGHT ANGLE PLUGS FULL CRIMP TYPE FOR FLEXIBLE CABLES



cable	part number	dimensions		captive center contact	assembly	note
		B	C			
5 / 50/ S	R141 182 000*	5.5	1.05	yes	M07	single piece body
5 / 50/ D	R141 183 000	5.8	1.05	yes	M07	single piece body

For others types of cables (75Ω, 93Ω or BT cables), please see "additional connectors" on page 36-37.

\* Packaging = 100 pieces.

### M 01

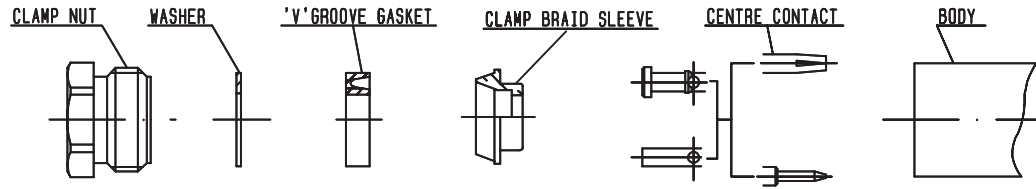

P/N	STRIPPING DIM.			RECOMMENDED COUPLING TORQUE
	a	b	c	
R141 009 000 R141 010 000	4.5	2.5	8.5	450 N.cm
R141 013 000	5.5	0.5	6	
R142 016 000	2.5	3	7	
R141 018 000 R142 018 000	3	1	9	
R141 156 000 R142 157 000	2.5	3	7	
R141 207 000	3	1	9	
R141 208 000 R141 258 000 R141 259 000 R142 268 000 R141 327 000 R142 329 000	2.5	3	7	

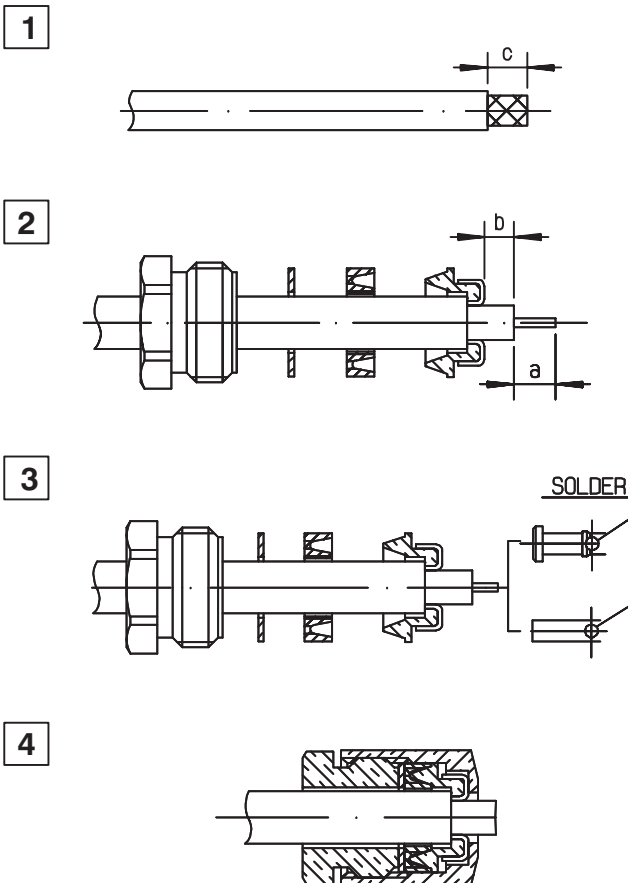

1.1 Strip the cable .

- 2.1 Slide the clamp nut , the washer and the 'V'groove gasket onto the cable .
- 2.2 Slide clamp braid sleeve over braid .
- 2.3 Fold back braid and trim off excess braid .
- 2.4 Trim back dielectric as shown .

3.1 Solder the cable inner conductor into centre contact .

4.1 Screw sub-assembly into the connector body .