

Thyristor Module

preliminary

$$V_{RRM} = 2 \times 1600 \text{ V}$$



$$I_{TAV} = 260 \text{ A}$$

$$V_T = 1.15 \text{ V}$$

Phase leg

Part number

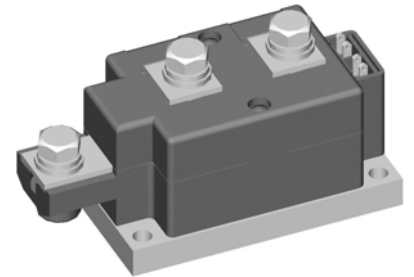
MCMA265P1600KA

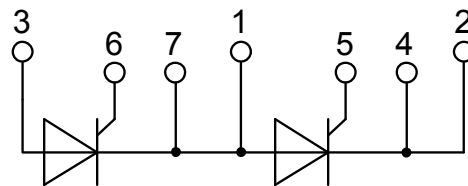
Features / Advantages:

- Thyristor for line frequency
- Planar passivated chip
- Long-term stability
- Direct Copper Bonded Al₂O₃-ceramic

Applications:

- Line rectifying 50/60 Hz
- Softstart AC motor control
- DC Motor control
- Power converter
- AC power control
- Lighting and temperature control

Package: Y1

- Isolation Voltage: 4800 V~
- Industry standard outline
- RoHS compliant
- Soldering pins for PCB mounting
- Base plate: Copper internally DCB isolated
- Advanced power cycling

Thyristor			Ratings				
Symbol	Definition	Conditions	min.	typ.	max.	Unit	
$V_{RSM/DSM}$	max. non-repetitive reverse/forward blocking voltage	$T_{VJ} = 25^{\circ}\text{C}$			1700	V	
$V_{RRM/DRM}$	max. repetitive reverse/forward blocking voltage	$T_{VJ} = 25^{\circ}\text{C}$			1600	V	
I_{RD}	reverse current, drain current	$V_{RD} = 1600\text{ V}$	$T_{VJ} = 25^{\circ}\text{C}$		300	μA	
		$V_{RD} = 1600\text{ V}$	$T_{VJ} = 140^{\circ}\text{C}$		30	mA	
V_T	forward voltage drop	$I_T = 300\text{ A}$	$T_{VJ} = 25^{\circ}\text{C}$		1.19	V	
		$I_T = 600\text{ A}$			1.46	V	
		$I_T = 300\text{ A}$	$T_{VJ} = 125^{\circ}\text{C}$			1.15	V
		$I_T = 600\text{ A}$				1.44	V
I_{TAV}	average forward current	$T_C = 85^{\circ}\text{C}$	$T_{VJ} = 140^{\circ}\text{C}$		260	A	
$I_{T(RMS)}$	RMS forward current	180° sine			408	A	
V_{T0}	threshold voltage	} for power loss calculation only	$T_{VJ} = 140^{\circ}\text{C}$		0.80	V	
r_T	slope resistance				0.75	m Ω	
R_{thJC}	thermal resistance junction to case				0.16	K/W	
R_{thCH}	thermal resistance case to heatsink			0.04		K/W	
P_{tot}	total power dissipation		$T_C = 25^{\circ}\text{C}$		720	W	
I_{TSM}	max. forward surge current	$t = 10\text{ ms}; (50\text{ Hz}), \text{ sine}$	$T_{VJ} = 45^{\circ}\text{C}$		8.50	kA	
		$t = 8,3\text{ ms}; (60\text{ Hz}), \text{ sine}$	$V_R = 0\text{ V}$		9.18	kA	
		$t = 10\text{ ms}; (50\text{ Hz}), \text{ sine}$	$T_{VJ} = 140^{\circ}\text{C}$		7.23	kA	
		$t = 8,3\text{ ms}; (60\text{ Hz}), \text{ sine}$	$V_R = 0\text{ V}$		7.81	kA	
I^2t	value for fusing	$t = 10\text{ ms}; (50\text{ Hz}), \text{ sine}$	$T_{VJ} = 45^{\circ}\text{C}$		361.3	kA ² s	
		$t = 8,3\text{ ms}; (60\text{ Hz}), \text{ sine}$	$V_R = 0\text{ V}$		350.6	kA ² s	
		$t = 10\text{ ms}; (50\text{ Hz}), \text{ sine}$	$T_{VJ} = 140^{\circ}\text{C}$		261.0	kA ² s	
		$t = 8,3\text{ ms}; (60\text{ Hz}), \text{ sine}$	$V_R = 0\text{ V}$		253.4	kA ² s	
C_J	junction capacitance	$V_R = 400\text{ V}$ $f = 1\text{ MHz}$	$T_{VJ} = 25^{\circ}\text{C}$		366	pF	
P_{GM}	max. gate power dissipation	$t_p = 30\text{ }\mu\text{s}$	$T_C = 140^{\circ}\text{C}$		120	W	
		$t_p = 500\text{ }\mu\text{s}$			60	W	
P_{GAV}	average gate power dissipation				20	W	
$(di/dt)_{cr}$	critical rate of rise of current	$T_{VJ} = 140^{\circ}\text{C}; f = 50\text{ Hz}$ repetitive, $I_T = 750\text{ A}$			100	A/ μs	
		$t_p = 200\text{ }\mu\text{s}; di_G/dt = 1\text{ A}/\mu\text{s};$ $I_G = 1\text{ A}; V_D = \frac{2}{3} V_{DRM}$ non-repet., $I_T = 268\text{ A}$			500	A/ μs	
$(dv/dt)_{cr}$	critical rate of rise of voltage	$V_D = \frac{2}{3} V_{DRM}$ $R_{GK} = \infty$; method 1 (linear voltage rise)	$T_{VJ} = 140^{\circ}\text{C}$		1000	V/ μs	
V_{GT}	gate trigger voltage	$V_D = 6\text{ V}$	$T_{VJ} = 25^{\circ}\text{C}$		2	V	
			$T_{VJ} = -40^{\circ}\text{C}$		3	V	
I_{GT}	gate trigger current	$V_D = 6\text{ V}$	$T_{VJ} = 25^{\circ}\text{C}$		150	mA	
			$T_{VJ} = -40^{\circ}\text{C}$		220	mA	
V_{GD}	gate non-trigger voltage	$V_D = \frac{2}{3} V_{DRM}$	$T_{VJ} = 140^{\circ}\text{C}$		0.25	V	
I_{GD}	gate non-trigger current				10	mA	
I_L	latching current	$t_p = 30\text{ }\mu\text{s}$	$T_{VJ} = 25^{\circ}\text{C}$		200	mA	
		$I_G = 0.45\text{ A}; di_G/dt = 0.45\text{ A}/\mu\text{s}$					
I_H	holding current	$V_D = 6\text{ V}$ $R_{GK} = \infty$	$T_{VJ} = 25^{\circ}\text{C}$		150	mA	
t_{gd}	gate controlled delay time	$V_D = \frac{1}{2} V_{DRM}$	$T_{VJ} = 25^{\circ}\text{C}$		2	μs	
		$I_G = 1\text{ A}; di_G/dt = 1\text{ A}/\mu\text{s}$					
t_q	turn-off time	$V_R = 100\text{ V}; I_T = 300\text{ A}; V_D = \frac{2}{3} V_{DRM}$ $di/dt = 10\text{ A}/\mu\text{s}; dv/dt = 50\text{ V}/\mu\text{s}; t_p = 200\text{ }\mu\text{s}$	$T_{VJ} = 140^{\circ}\text{C}$		200	μs	

Package Y1			Ratings			
Symbol	Definition	Conditions	min.	typ.	max.	Unit
I_{RMS}	RMS current	per terminal			600	A
T_{stg}	storage temperature		-40		125	°C
T_{VJ}	virtual junction temperature		-40		140	°C
Weight				680		g
M_D	mounting torque		4.5		7	Nm
M_T	terminal torque		11		13	Nm
$d_{Spp/App}$	creepage distance on surface striking distance through air	terminal to terminal	16.0			mm
$d_{Spb/Apb}$		terminal to backside	16.0			mm
V_{ISOL}	isolation voltage	t = 1 second	4800			V
		t = 1 minute	4000			V

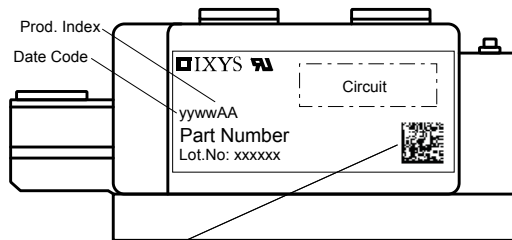

Data Matrix: Typ (1-19), DC+Prod.Index (20-25), FKT# (26-31)
leer (33), lfd.# (33-36)

Part number

- M = Module
- C = Thyristor (SCR)
- M = Thyristor
- A = (up to 1800V)
- 265 = Current Rating [A]
- P = Phase leg
- 1600 = Reverse Voltage [V]
- KA = Y1-CU

Ordering	Part Number	Marking on Product	Delivery Mode	Quantity	Code No.
Standard	MCMA265P1600KA	MCMA265P1600KA	Box	3	509792

Equivalent Circuits for Simulation

* on die level

$T_{VJ} = 140^\circ\text{C}$

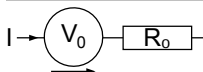

Thyristor

$V_{0\ max}$	threshold voltage	0.8	V
$R_{0\ max}$	slope resistance *	0.51	mΩ

Outlines Y1

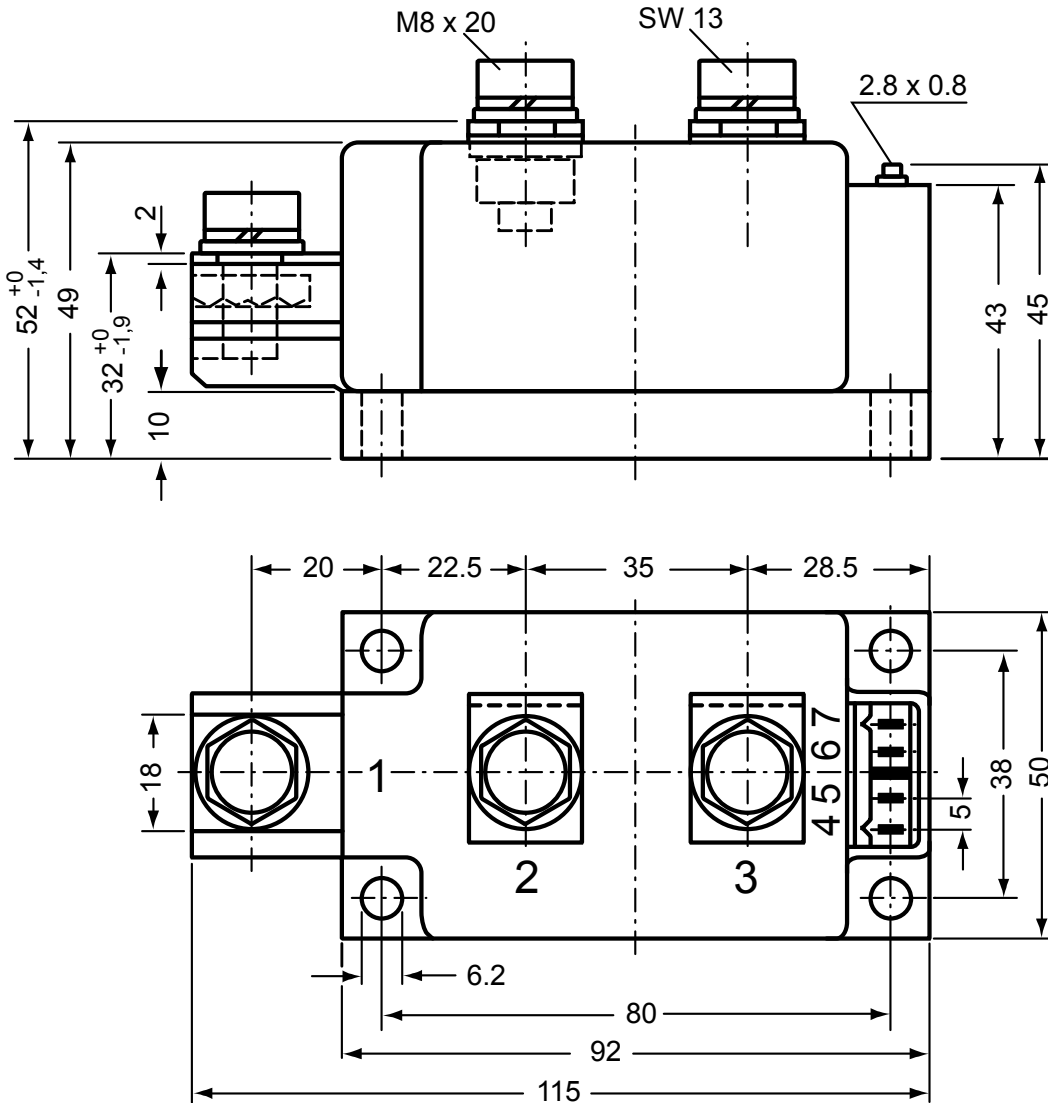

Optional accessories for modules

Keyed gate/cathode twin plugs with wire length = 350 mm, gate = white, cathode = red

Type ZY 180L (L = Left for pin pair 4/5) } UL 758, style 3751
 Type ZY 180R (R = Right for pin pair 6/7)

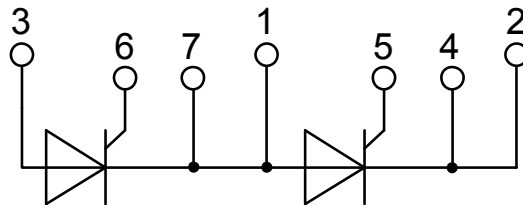

Thyristor

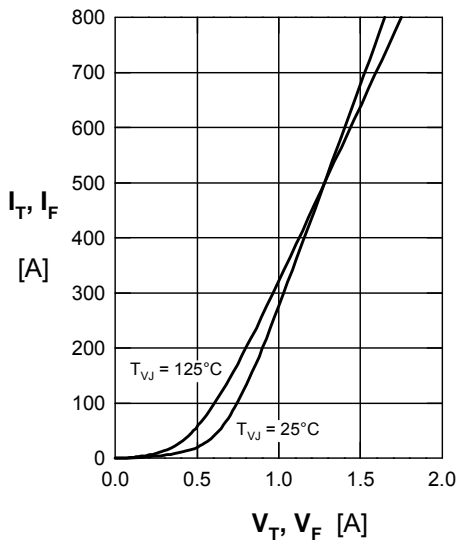

Fig. 1 Forward voltage drop

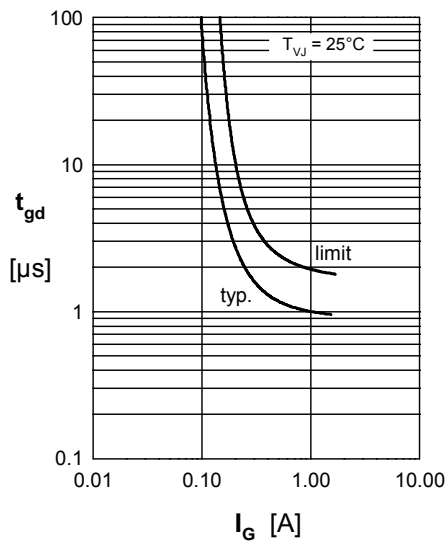

Fig. 2 Gate trigger delay time

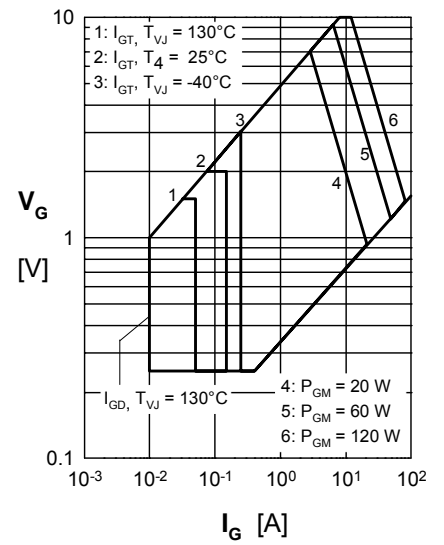

Fig. 3 Gate trigger characteristics

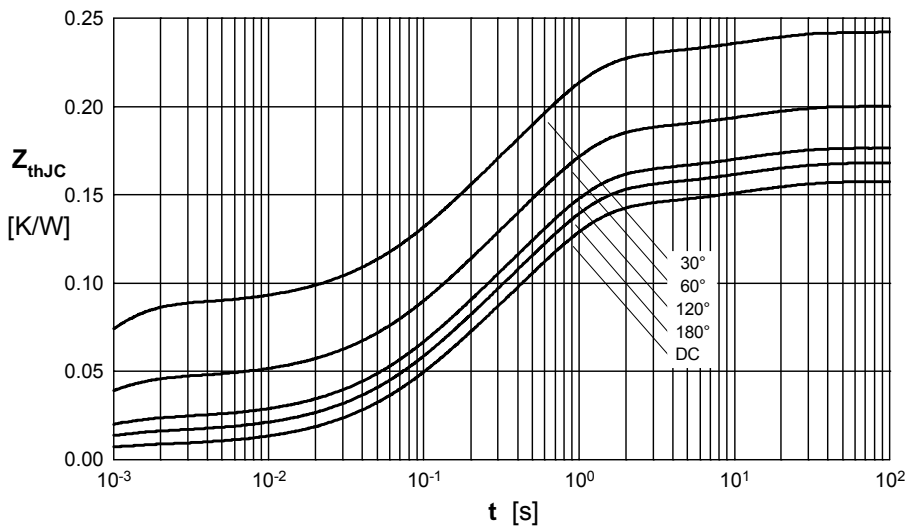

Fig. 4 Transient thermal impedance junction to case (per thyristor/diode)

R_{thJC} for various conduction angles d:

d	R_{thJC} (K/W)
DC	0.157
180°	0.168
120°	0.177
60°	0.200
30°	0.243

Constants for Z_{th} calculation:

i	R_{thi} (K/W)	t_i (s)
1	0.0076	0.0054
2	0.0406	0.098
3	0.0944	0.54
4	0.0147	12