

## MAX38907/MAX38908

## 4A, High-Performance LDO Linear Regulators

### General Description

The MAX38907/MAX38908 are fast transient response, high-PSRR nMOS linear regulators that deliver up to 4A load current.

These regulators support a wide input supply range from 0.9V up to 5.5V, and BIAS voltage range from 2.7V to 20V to provide wider supply options in a variety of applications. Output accuracy of  $\pm 1\%$  is maintained over line, load, and temperature variations, requiring only 300mV of input-to-output headroom at full load for a good PSRR. The output voltage can be adjusted to a value in the range of 0.6V to 5.0V to accommodate customers that desire to specify a single LDO in the BOM for multiple voltage rails.

The MAX38907 is configurable to one of 27 output voltages using three digital configuration pins. Additionally, each output voltage selection can be adjusted  $\pm 5\%$  for margining. The output voltage on the MAX38908 can be adjusted to a value in the range of 0.6V to 5.0V by using two external feedback resistors. These LDOs are fully protected from damage by internal circuitry that provides programmable inrush current limiting, output overcurrent limiting, reverse-current limiting, and thermal overload protection.

The MAX38907 is offered in a 20-pin, 5mm x 5mm TQFN package, while the MAX38908 is offered in 5 x 3 bump, 0.4mm pitch WLP and 14-pin, 3mm x 3mm TDFN packages.

### Applications

- FPGAs and DSPs
- Medical, Audio, and Instrumentation
- Server  $\mu$ Ps
- Portable Cameras
- PLCs
- Base Stations

### Benefits and Features

- Delivers Flexible Operating Range
  - 0.9V to 5.5V Input Voltage Range
  - 2.7V to 20V BIAS Voltage Range
  - 0.6V to 5.0V Programmable Output Voltage
  - 4A Maximum Output Current
  - 51mV Dropout at 4A Load Current
  - 1.6mA Operating BIAS Supply Current
- Reduces Noise and Improves Accuracy
  - $\pm 1\%$  DC Accuracy over Load, Line, and Temperature
  - 28mV, 4A Load-Transient Excursion
  - 78dB BIAS PSRR at 10kHz
  - 52dB IN PSRR at 10kHz at 300mV Input-to-Output Headroom
- Enables Ease-of-Use and Robust Protection
  - Stable with 10 $\mu$ F (Minimum) Output Capacitance
  - Programmable Soft-Start Rate
  - Overcurrent and Overtemperature Protection
  - Output-to-Input Reverse-Current Protection
  - Power-OK Status Pin
- Reduces Size, Improves Reliability
  - 14-Pin (3mm x 3mm) TDFN, 20-Pin (5mm x 5mm) TQFN, and 5 x 3 Bump, 0.4mm Pitch WLP
  - -40°C to +125°C Operating Temperature

[Ordering Information](#) appears at end of data sheet.

Typical Application Circuits

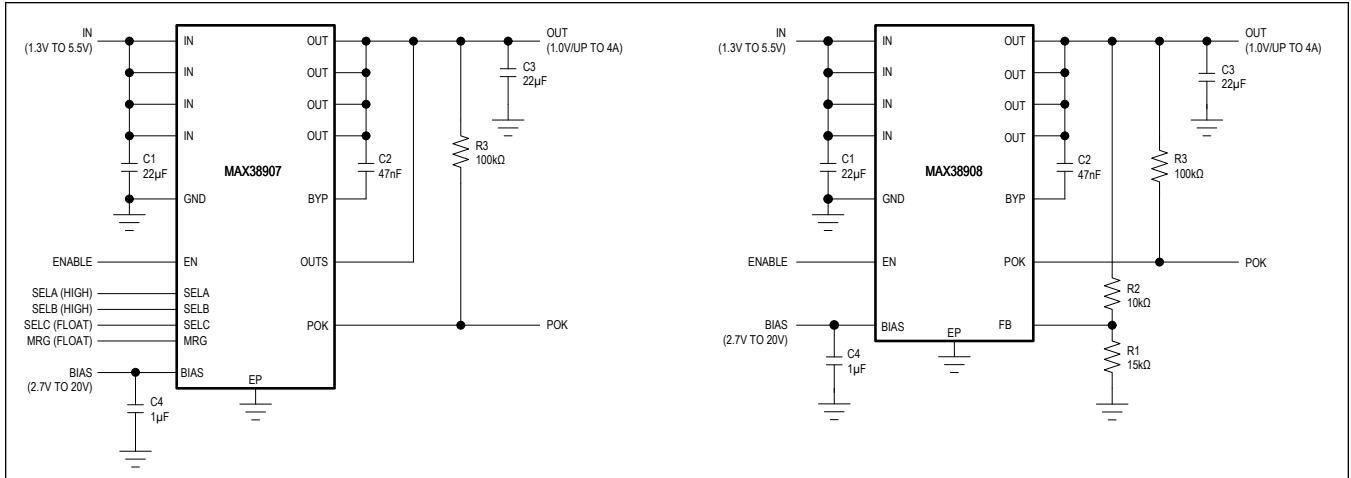

---

**TABLE OF CONTENTS**

---

General Description . . . . .	1
Applications . . . . .	1
Benefits and Features . . . . .	1
Typical Application Circuits . . . . .	2
Absolute Maximum Ratings . . . . .	6
Package Information . . . . .	6
14 TDFN . . . . .	6
20 TQFN . . . . .	6
WLP . . . . .	6
Electrical Characteristics . . . . .	7
Typical Operating Characteristics . . . . .	10
Pin Configurations . . . . .	13
20 TQFN . . . . .	13
14 TDFN . . . . .	14
WLP . . . . .	15
Pin Description . . . . .	15
Functional Diagram . . . . .	17
Detailed Description . . . . .	18
Enable . . . . .	18
Bypass . . . . .	18
Power OK . . . . .	18
Protection . . . . .	19
Undervoltage Lockout (UVLO) . . . . .	20
Active Discharge . . . . .	21
Output Voltage Selection . . . . .	21
Select Version . . . . .	21
Feedback Version . . . . .	22
Applications Information . . . . .	24
Input and Output Capacitors . . . . .	24
Thermal Design . . . . .	24
Ordering Information . . . . .	24
Revision History . . . . .	25

---

**LIST OF FIGURES**

---

Figure 1. Typical POK Operation ..... 19  
Figure 2. Typical IN UVLO Operation ..... 20  
Figure 3. Startup into Dropout ..... 21

---

**LIST OF TABLES**

---

Table 1. MAX38907 Output Voltage Configuration . . . . .	21
Table 2. Recommended Feedback Resistor Values . . . . .	22

**Absolute Maximum Ratings**

IN, FB, OUT, OUTS, BYP, POK, MRG to GND.....	-0.3V to +6V	WLP (derate 16.2mW/°C, T <sub>A</sub> = +70°C).....	1312mW
BIAS to GND .....	-0.3V to +22V	Operating Temperature Range .....	-40°C to +125°C
EN, SELA, SELB, SELC to GND.....	-0.3V to BIAS + 0.3V	Maximum Junction Temperature .....	+150°C
Output Short-Circuit Duration .....	Continuous	Storage Temperature Range .....	-65°C to +150°C
Continuous Power Dissipation (T <sub>A</sub> = +70°C) .		Lead Temperature (Soldering, 10 second) .....	+300°C
TDFN (derate 24.4mW/°C, T <sub>A</sub> = +70°C).....	1951.2mW	Soldering Temperature (reflow) .....	+260°C
TQFN (derate 33.3mW/°C, T <sub>A</sub> = +70°C) .....	2666.7mW		

Stresses beyond those listed under "Absolute Maximum Ratings" may cause permanent damage to the device. These are stress ratings only, and functional operation of the device at these or any other conditions beyond those indicated in the operational sections of the specifications is not implied. Exposure to absolute maximum rating conditions for extended periods may affect device reliability.

**Package Information**

**14 TDFN**

Package Code	T1433+2C
Outline Number	<a href="#">21-0137</a>
Land Pattern Number	<a href="#">90-0063</a>
<b>Thermal Resistance, Single-Layer Board:</b>	
Junction to Ambient (θ <sub>JA</sub> )	54°C/W
Junction to Case (θ <sub>JC</sub> )	8°C/W
<b>Thermal Resistance, Four-Layer Board:</b>	
Junction to Ambient (θ <sub>JA</sub> )	41°C/W
Junction to Case (θ <sub>JC</sub> )	8°C/W

**20 TQFN**

Package Code	T2055+4C
Outline Number	<a href="#">21-0140</a>
Land Pattern Number	<a href="#">90-0009</a>
<b>Thermal Resistance, Single-Layer Board:</b>	
Junction to Ambient (θ <sub>JA</sub> )	48°C/W
Junction to Case (θ <sub>JC</sub> )	2°C/W
<b>Thermal Resistance, Four-Layer Board:</b>	
Junction to Ambient (θ <sub>JA</sub> )	30°C/W
Junction to Case (θ <sub>JC</sub> )	2°C/W

**WLP**

Package Code	N151C2+1
Outline Number	<a href="#">21-100372</a>
Land Pattern Number	Refer to <a href="#">Application Note 1891</a>
<b>Thermal Resistance, Four-Layer Board:</b>	
Junction to Ambient (θ <sub>JA</sub> )	61.65°C/W
Junction to Case (θ <sub>JC</sub> )	N/A

For the latest package outline information and land patterns (footprints), go to [www.maximintegrated.com/packages](http://www.maximintegrated.com/packages).

Note that a “+”, “#”, or “-” in the package code indicates RoHS status only. Package drawings may show a different suffix character, but the drawing pertains to the package regardless of RoHS status.

Package thermal resistances were obtained using the method described in JEDEC specification JESD51-7, using a four-layer board. For detailed information on package thermal considerations, refer to [www.maximintegrated.com/thermal-tutorial](http://www.maximintegrated.com/thermal-tutorial).

## Electrical Characteristics

( $V_{IN} = 1.5V$ ,  $V_{OUT} = 1.0V$ ,  $V_{BIAS} = 10V$ ,  $T_J = -40^{\circ}C$  to  $+125^{\circ}C$ ,  $C_{IN} = 22\mu F$ ,  $C_{OUT} = 22\mu F$ ,  $C_{BYP} = 1nF$ , unless noted otherwise. (*Note 1*))

PARAMETER	SYMBOL	CONDITIONS	MIN	TYP	MAX	UNITS
Input Voltage Range	$V_{IN}$	Guaranteed by Output Accuracy, $V_{OUT} < V_{IN} - V_{DO}$	0.9		5.5	V
Bias Voltage Range	$V_{BIAS}$		2.7		20	V
Input Undervoltage Lockout	$V_{IN\_UVLO}$	$V_{IN}$ rising, 60mV hysteresis	0.35	0.45	0.55	V
Bias Undervoltage Lockout	$V_{BIAS\_UVLO}$	$V_{BIAS}$ rising, 100mV hysteresis	2.45	2.55	2.65	V
Output Voltage Range	$V_{OUT}$	Guaranteed by Output Accuracy	0.6		5.0	V
Output Capacitance	$C_{OUT}$	Effective capacitance required for stability and proper operation	10	22		$\mu F$
Input Supply Current	$I_Q$	$V_{EN} = 3.6V$ , $V_{BIAS} = 5.0V$ , $I_{OUT} = 0mA$		70.5	150	$\mu A$
Input Shutdown Current	$I_{SD}$	$V_{EN} = 0V$	$T_J = +25^{\circ}C$	0.001	1	$\mu A$
			$T_J = +125^{\circ}C$	1		
Bias Supply Current	$I_{BIAS}$	$V_{EN} = 3.3V$ , $V_{BIAS} = 5.0V$ , $I_{OUT} = 0mA$		1.5	4	mA
		$V_{EN} = 3.3V$ , $V_{BIAS} = 5.0V$ , $I_{OUT} = 4A$		1.6		
	$I_{BIAS\_SD}$	$V_{EN} = 0V$		0.75	4	$\mu A$
Output Accuracy (MAX38907)	ACC	$I_{OUT}$ from 10mA to 4A, $V_{IN}$ from $V_{OUT} + 0.3V$ to 5.5V, $V_{BIAS} > 2.7V$ , $V_{BIAS}$ from $V_{OUT} + 2V$ to 20V, $V_{OUT}$ from 0.6V to 5.0V	-1		+1	%
Feedback Voltage Accuracy (MAX38908)	$V_{FB}$	$I_{OUT}$ from 10mA to 4A, $V_{IN}$ from $V_{OUT} + 0.3V$ to 5.5V, $V_{BIAS} > 2.7V$ , $V_{BIAS}$ from $V_{OUT} + 2V$ to 20V, $V_{OUT}$ from 0.6V to 5.0V	0.594	0.6	0.606	V
Load Regulation		$I_{OUT}$ from 0.1mA to 4A, $C_{BYP} = 47nF$		0.1		%
Load Transient		$I_{OUT} = 40mA$ to 4A and 4A to 40mA, $di/dt = 1A/\mu s$ , $C_{OUT} = 3 \times 10\mu F$ , $C_{BYP} = 47nF$		28		mV
Line Regulation		$V_{IN}$ from $V_{OUT} + 0.3V$ to 5.5V, $I_{OUT} = 1A$ , $C_{BYP} = 47nF$		0.04		%/V
Line Transient		$V_{IN} = 1.0V$ to 1.2V to 1.0V, 10V/ms $V_{IN}$ slew rate, $I_{OUT} = 4A$ , $V_{OUT} = 0.8V$ , $C_{BYP} = 47nF$		8.2		mV

## Electrical Characteristics (continued)

( $V_{IN} = 1.5V$ ,  $V_{OUT} = 1.0V$ ,  $V_{BIAS} = 10V$ ,  $T_J = -40^\circ C$  to  $+125^\circ C$ ,  $C_{IN} = 22\mu F$ ,  $C_{OUT} = 22\mu F$ ,  $C_{BYP} = 1nF$ , unless noted otherwise. ([Note 1](#)))

PARAMETER	SYMBOL	CONDITIONS		MIN	TYP	MAX	UNITS
Dropout Voltage (MAX38908) ( <a href="#">Note 2</a> )	$V_{DO}$	$I_{OUT} = 4A$ , $V_{OUT\_NOM} = 1.2V$	$V_{BIAS} = 5.0V$ , TDFN		79	150	mV
			$V_{BIAS} = 5.0V$ , WLP		52		
			$V_{BIAS} = 3.3V$ , TDFN		105	210	
			$V_{BIAS} = 3.3V$ , WLP		86		
		$I_{OUT} = 4A$ , $V_{OUT\_NOM} = 2.5V$	$V_{BIAS} = 5.0V$ , TDFN		92	180	
			$V_{BIAS} = 5.0V$ , WLP		70		
		$I_{OUT} = 4A$ , $V_{OUT\_NOM} = 5.0V$	$V_{BIAS} = 12V$ , TDFN		79	150	
			$V_{BIAS} = 12V$ , WLP		51		
Current Limit	$I_{LIM}$	$V_{OUTS/OUT} = 0.9 \times V_{OUT\_NOM}$ , $V_{IN} - V_{OUT} = 300mV$		4.4	5.6	6.8	A
Output Noise		$I_{OUT} = 0.5A$ , 10Hz to 100kHz, $V_{OUT} = 1.2V$	$C_{BYP} = 47nF$		21.2		$\mu V_{RMS}$
IN Power Supply Rejection Ratio	PSRR	$V_{IN} - V_{OUT} = 0.3V$ , $I_{OUT} = 1A$ , $C_{OUT} = 4 \times 10\mu F$ , $C_{BYP} = 47nF$ , $V_{BIAS} > 2.7V$ , $V_{BIAS} = V_{OUT} + 2V$ , $T_A = +25^\circ C$	$f = 1kHz$		59		dB
			$f = 10kHz$		52		
			$f = 100kHz$		42		
BIAS Supply Rejection Ratio	PSRR	$V_{IN} - V_{OUT} = 0.3V$ , $I_{OUT} = 1A$ , $C_{OUT} = 4 \times 10\mu F$ , $C_{BYP} = 47nF$ , $V_{BIAS} = V_{OUT} + 5V$ , $T_A = +25^\circ C$	$f = 1kHz$		90		dB
			$f = 10kHz$		78		
			$f = 100kHz$		69		
BYP Capacitor Range	$C_{BYP}$	Regulator remains stable; guaranteed by design		0.001		0.1	$\mu F$
BYP Soft-Start Current	$I_{BYP}$	From BYP to GND during startup			50		$\mu A$
SELA/B/C Input Threshold (MAX38907)	$V_{IH}$	EN/SEL Rising			1.0	1.6	V
	$V_{IL}$	EN/SEL Falling		0.4	0.9		
SELA/B/C Input Leakage Current (MAX38907)	$I_{SEL\_LK}$	$V_{EN}$ , $V_{SEL}$ from 0 to 20V, $V_{BIAS} = 20V$	$T_A = +25^\circ C$	-1	0.001	1	$\mu A$
			$T_J = +125^\circ C$		0.01		
Output Margin Adjust Threshold (MAX38907)		$V_{MRG} = 1.8V$		4	5	6	%
		$V_{MRG} = 0V$		-6	-5	-4	
MRG Input Threshold (MAX38907)	$V_{IH}$	MRG rising		1.2	1.3	1.4	V
	$V_{IL}$	MRG falling		0.4	0.5	0.6	
		MRG hysteresis			0.05		



**Electrical Characteristics (continued)**

( $V_{IN} = 1.5V$ ,  $V_{OUT} = 1.0V$ ,  $V_{BIAS} = 10V$ ,  $T_J = -40^{\circ}C$  to  $+125^{\circ}C$ ,  $C_{IN} = 22\mu F$ ,  $C_{OUT} = 22\mu F$ ,  $C_{BYP} = 1nF$ , unless noted otherwise. ([Note 1](#)))

PARAMETER	SYMBOL	CONDITIONS		MIN	TYP	MAX	UNITS
MRG Input Current (MAX38907)		$V_{MRG}$ from 0V to 5.5V	$V_{MRG} = 0V$	-100	-1		$\mu A$
			$V_{MRG} = 5.5V$		1	100	
EN Input Threshold	$V_{IH}$	EN rising			1.0	1.6	V
	$V_{IL}$	EN falling		0.4	0.9		
EN Input Leakage Current	$I_{EN\_LK}$	$V_{EN}$ from 0V to 5.5V, $V_{BIAS}$ from 8V to 20V	$T_A = +25^{\circ}C$	-1	+0.001	+1	$\mu A$
			$T_J = +125^{\circ}C$		0.01		
POK Threshold		$V_{OUT}$ when POK switches	$V_{OUT}$ rising	88	91	94	%
			$V_{OUT}$ falling		88		
POK Voltage, Low	$V_{OL}$	$I_{POK} = 1mA$			10	100	mV
POK Leakage Current	$I_{POK\_LK}$	$V_{POK} = 5.5V$	$T_A = +25^{\circ}C$	-1	+0.001	+1	$\mu A$
			$T_J = +125^{\circ}C$		0.01		
IN Reverse-Current Threshold		$V_{OUT} = 1.2V$ , $V_{BIAS} = 10V$			700		mA
Thermal Shutdown Threshold		$T_J$ when output turns on/off	$T_J$ rising		165		$^{\circ}C$
			$T_J$ falling		150		

**Note 1:** Limits over the specified operating temperature and supply voltage range are guaranteed by design and characterization, and production tested at room temperature only.

**Note 2:** Dropout voltage is defined as ( $V_{IN} - V_{OUT}$ ) when  $V_{OUT}$  is 95% of its nominal value.

Typical Operating Characteristics

( $V_{IN} = 1.5V$ ,  $V_{BIAS} = 10V$ ,  $V_{OUT} = 1.0V$ ,  $C_{IN} = 22\mu F$ ,  $C_{OUT} = 22\mu F$ ,  $C_{BYP} = 47nF$ ,  $C_{BIAS} = 1\mu F$ ,  $T_A = +25^\circ C$ , unless otherwise noted.)

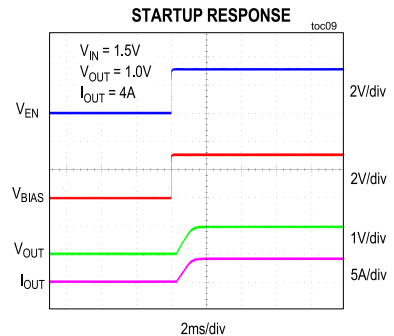
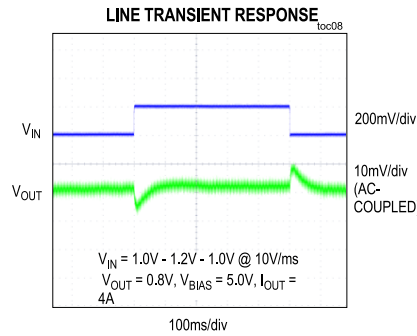
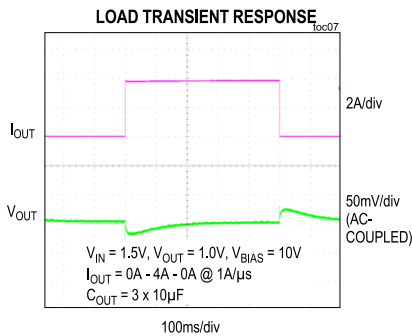
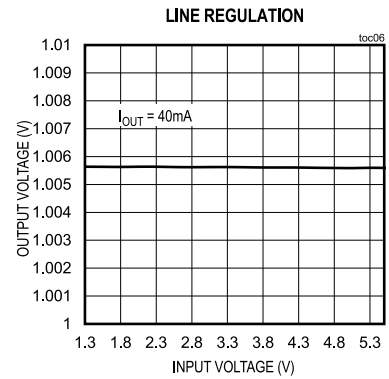
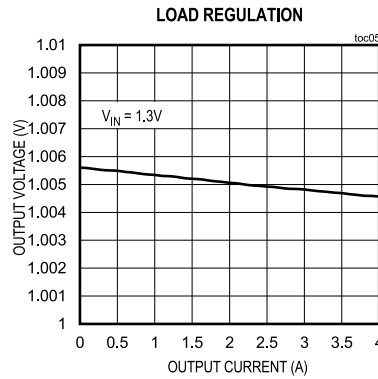
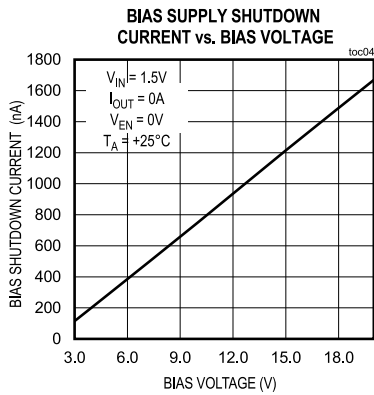
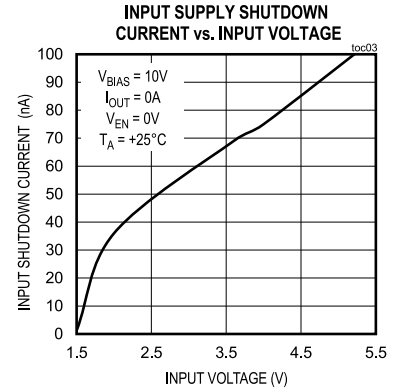
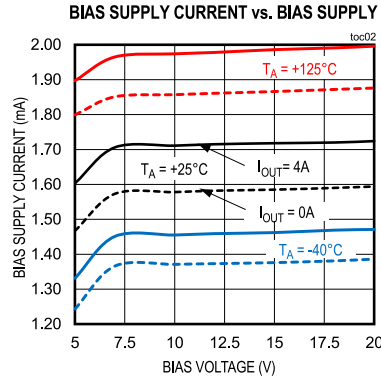
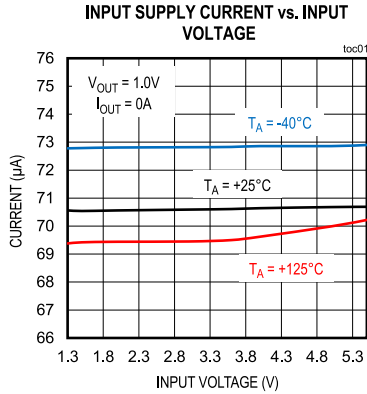

Typical Operating Characteristics (continued)

( $V_{IN} = 1.5V$ ,  $V_{BIAS} = 10V$ ,  $V_{OUT} = 1.0V$ ,  $C_{IN} = 22\mu F$ ,  $C_{OUT} = 22\mu F$ ,  $C_{BYP} = 47nF$ ,  $C_{BIAS} = 1\mu F$ ,  $T_A = +25^\circ C$ , unless otherwise noted.)

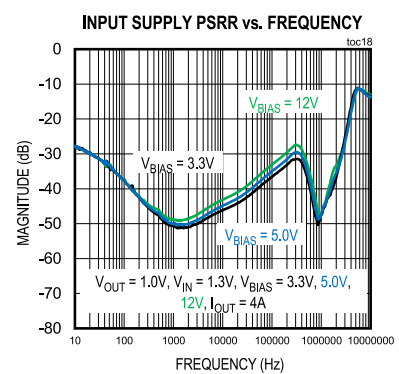
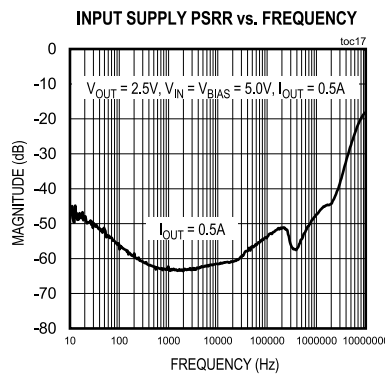
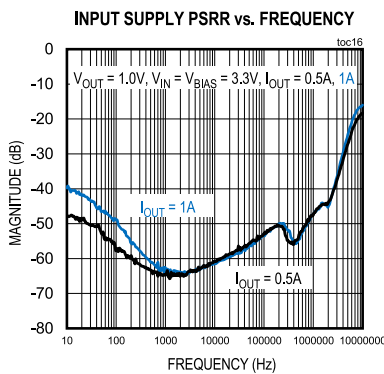
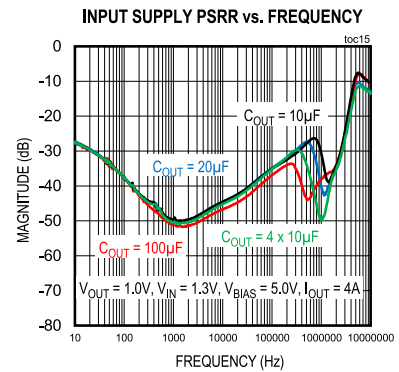
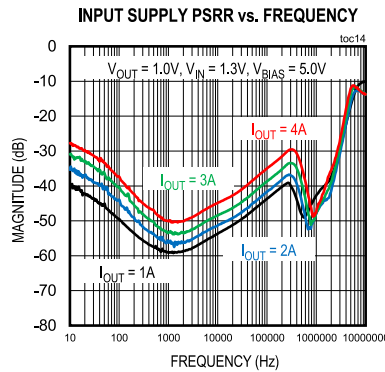
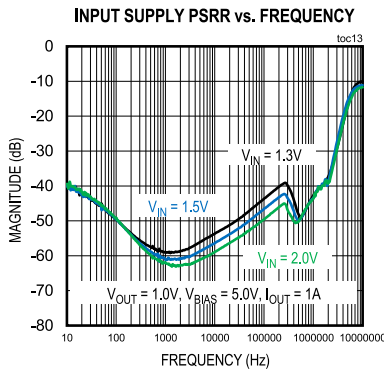
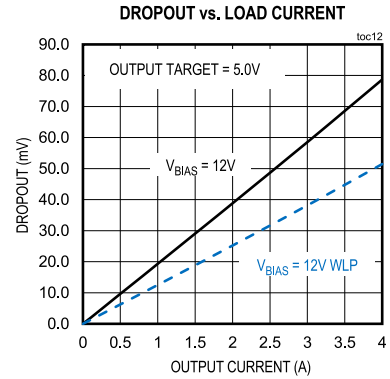
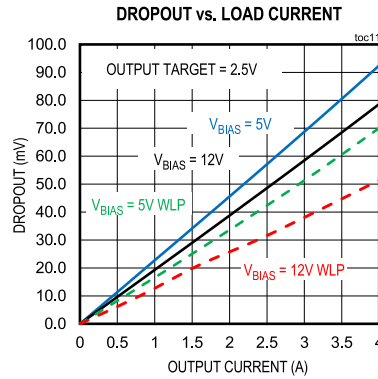
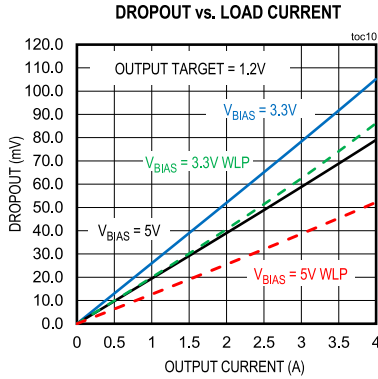

Typical Operating Characteristics (continued)

( $V_{IN} = 1.5V$ ,  $V_{BIAS} = 10V$ ,  $V_{OUT} = 1.0V$ ,  $C_{IN} = 22\mu F$ ,  $C_{OUT} = 22\mu F$ ,  $C_{BYP} = 47nF$ ,  $C_{BIAS} = 1\mu F$ ,  $T_A = +25^\circ C$ , unless otherwise noted.)

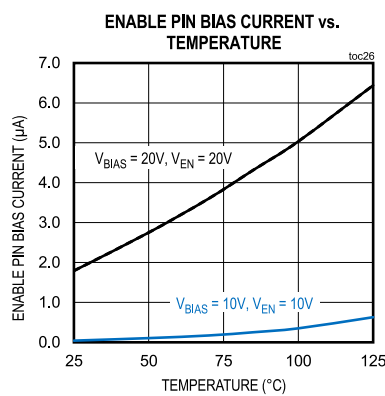
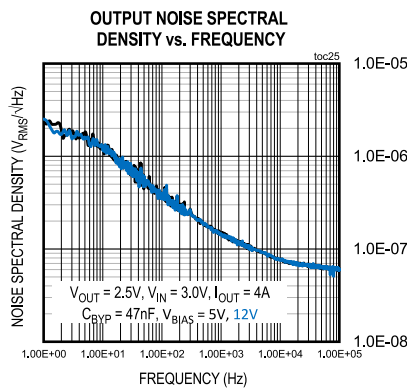
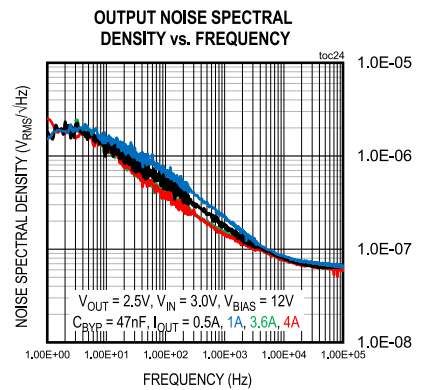
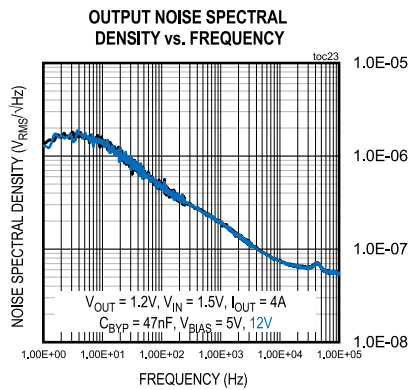
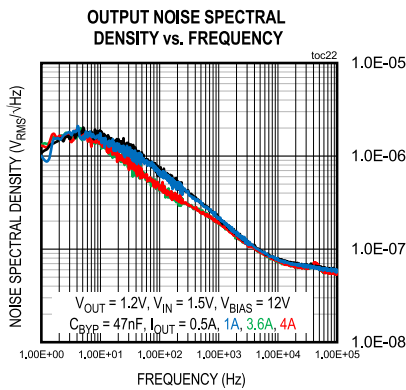
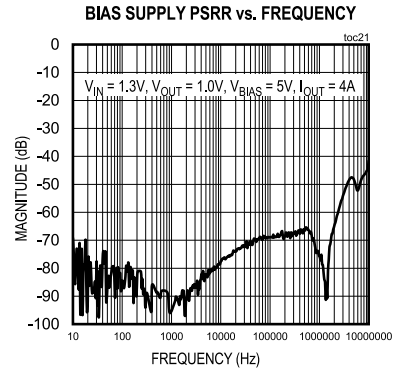
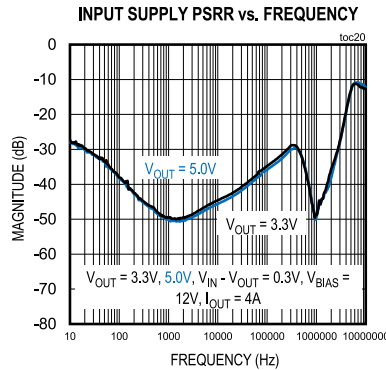
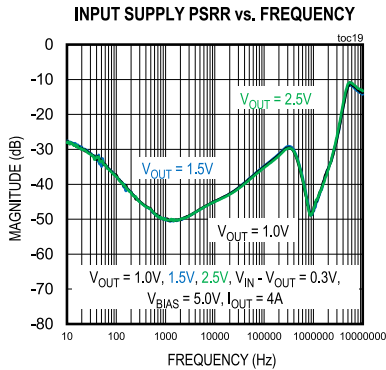

### Pin Configurations

#### 20 TQFN

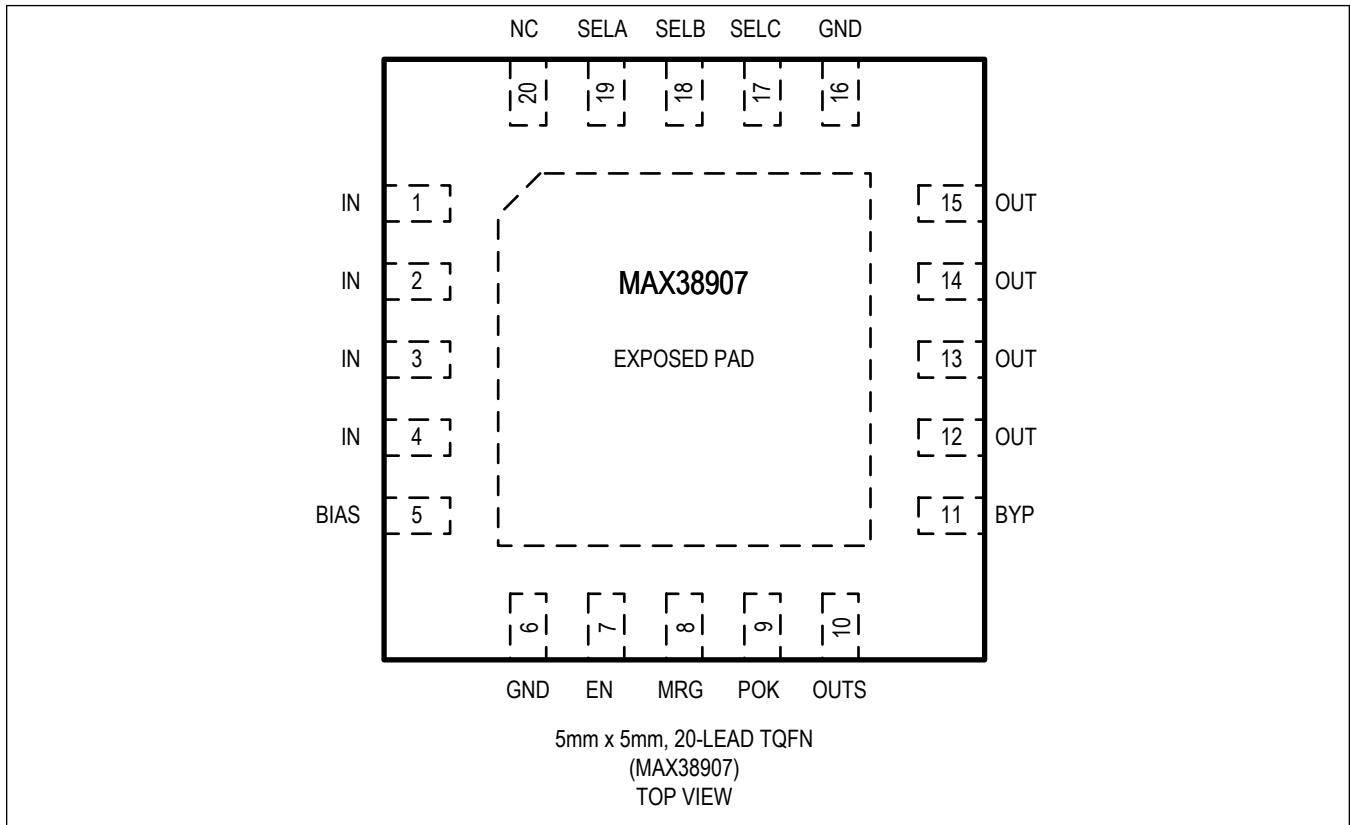

14 TDFN

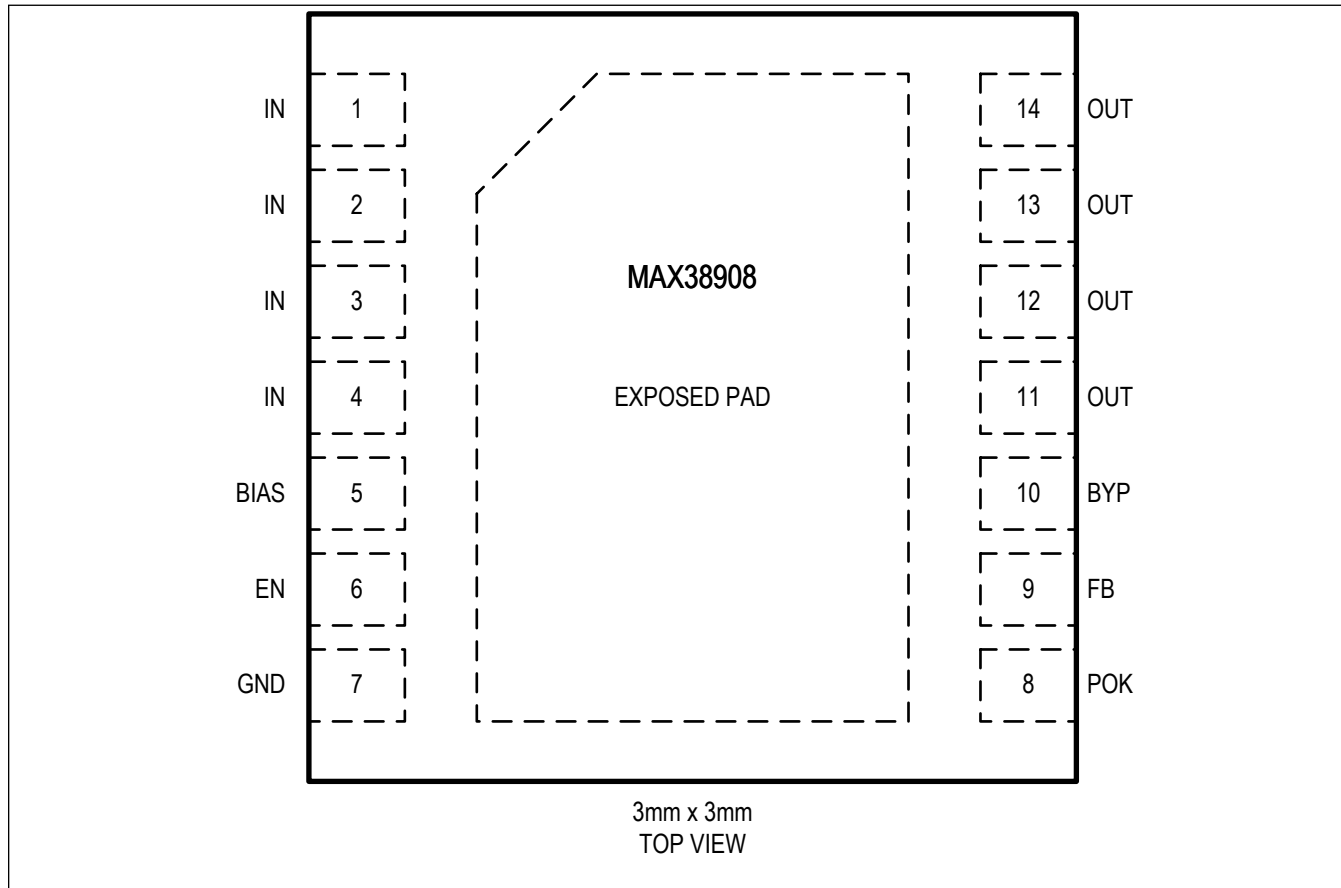

WLP

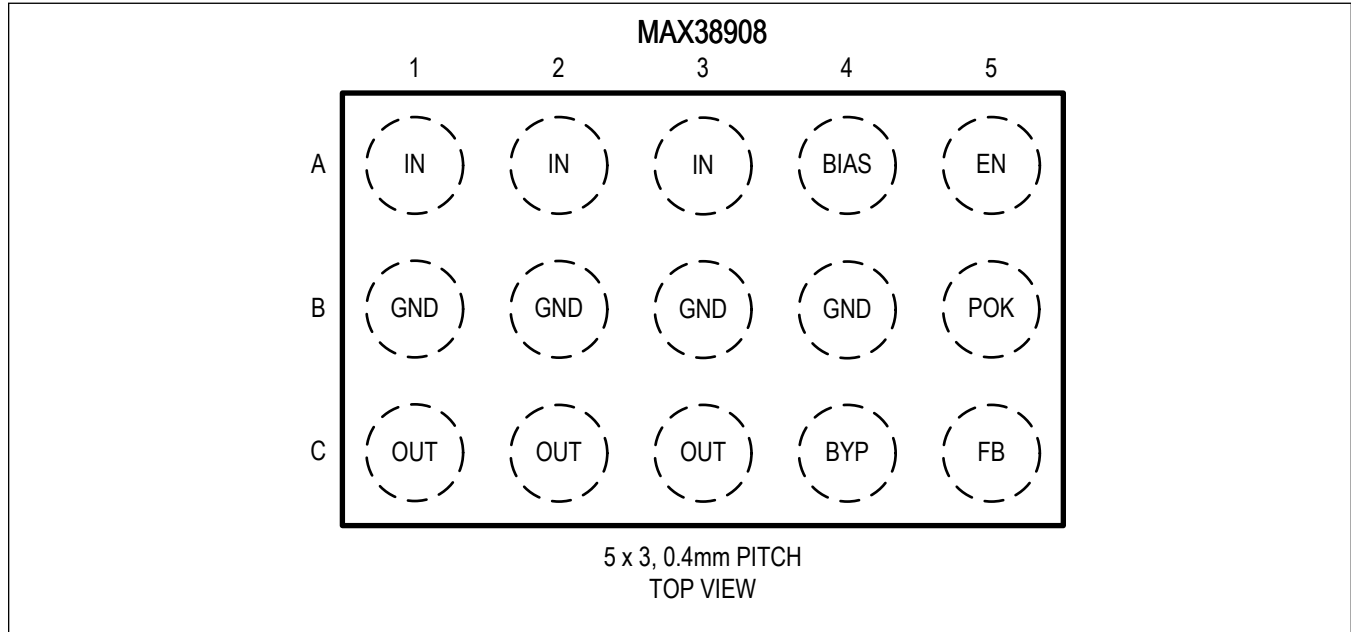

Pin Description

PIN			NAME	FUNCTION
20 TQFN	14 TDFN	WLP		
1, 2, 3, 4	1, 2, 3, 4	A1, A2, A3	IN	Regulator Supply Input. Connect to a voltage between 0.9V and 5.5V and bypass with a 22µF ceramic capacitor from IN to GND.
5	5	A4	BIAS	Bias Supply Input. Connect to a voltage between 2.7V and 20V and bypass with a 1µF capacitor from BIAS to GND. BIAS must be 2.0V or more above the V <sub>OUT</sub> target.
6, 16	7	B1, B2, B3, B4	GND	Regulator Ground. Bring IN and OUT bypass capacitor GND connections to this pin for best performance.
7	6	A5	EN	Enable Pin. Connect this pin to a logic signal to enable (V <sub>EN</sub> high) or disable (V <sub>EN</sub> low) the regulator output. Connect to BIAS to keep the output enabled whenever a valid supply voltage is present.
8	—	—	MRG	±5% Output Voltage Margin Adjustment Input. Float for normal operation. Pull to 0V to cause the output to regulate 5% lower, or pull above 1.4V to cause the output to regulate 5% higher than nominal.
9	8	B5	POK	Power-On Reset Output. Connect a pullup resistor from this pin to a supply to create a reset signal that goes high after the regulator output has reached its regulation target voltage.
10	—	—	OUTS	Output Voltage Sense. Connect to OUT where tight voltage regulation is required.
11	10	C4	BYP	Bypass Capacitor Input. Connect a 0.001µF to 0.1µF capacitor between OUT and BYP to reduce output noise.

## Pin Description (continued)

PIN			NAME	FUNCTION
20 TQFN	14 TDFN	WLP		
12, 13, 14, 15	11, 12, 13, 14	C1, C2, C3	OUT	Regulator Output. Sources up to 4A at the output regulation voltage. Bypass this pin with 22 $\mu$ F ceramic capacitor to GND. It is pulled low with a 70 $\Omega$ resistance when the regulator is disabled.
17	—	—	SELC	Logic Input 3 Used to Set Output Voltage of the LDO. Connect to GND, BIAS, or float.
18	—	—	SELB	Logic Input 2 Used to Set Output Voltage of the LDO. Connect to GND, BIAS, or float.
19	—	—	SELA	Logic Input 1 Used to Set Output Voltage of the LDO. Connect to GND, BIAS, or float.
20	—	—	NC	No Connect
EP	EP	—	EP	Exposed Pad. Connect the exposed pad to a ground plane with low thermal resistance to ambient to provide best heat sinking.
—	9	C5	FB	Output Voltage Feedback Input. Connect resistor-divider across OUT and GND with the center connected to this pin to set any output voltage between 0.6V and 5.0V.



Functional Diagram

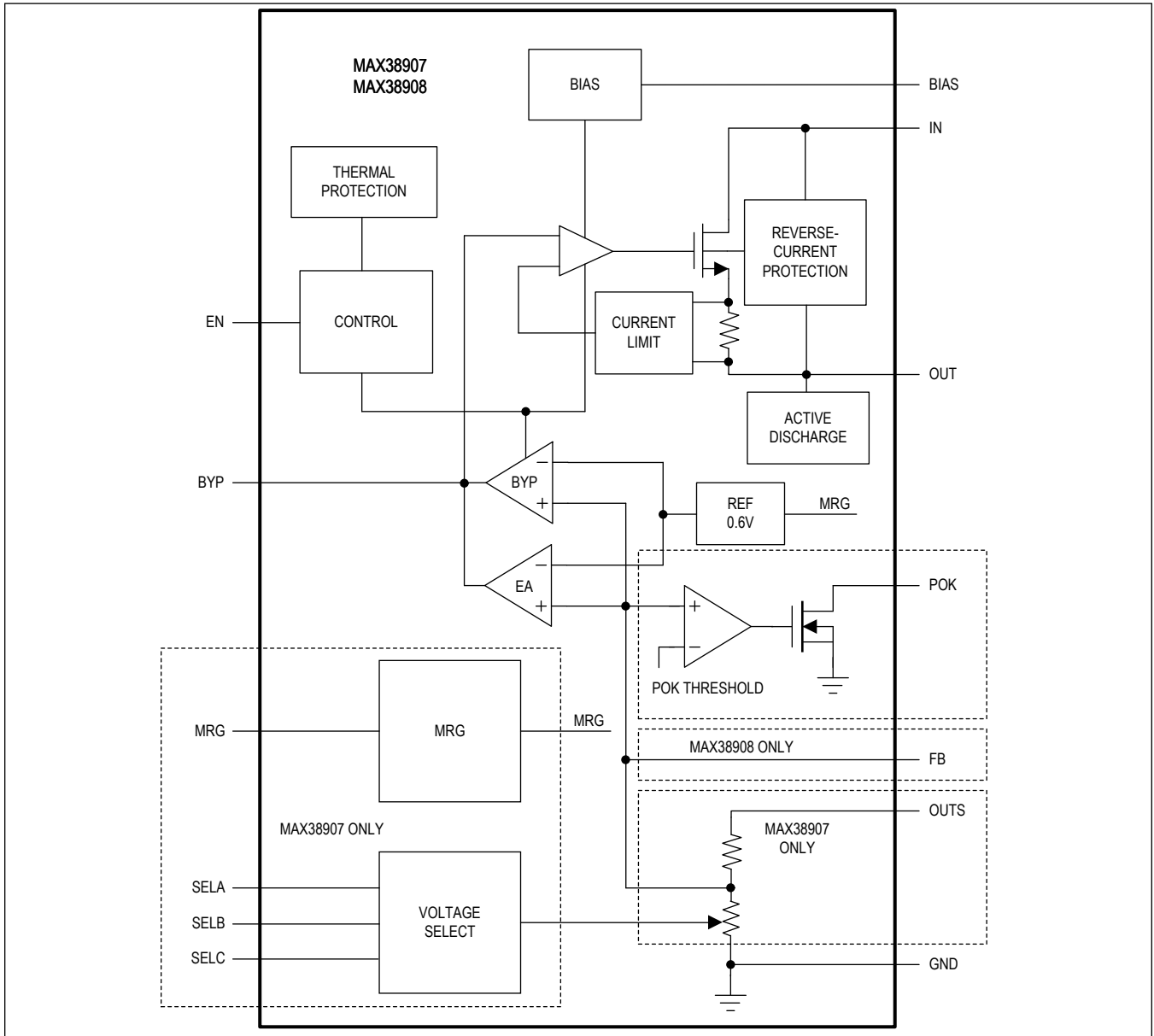

## Detailed Description

The MAX38907/MAX38908 are fast transient, high-PSRR linear regulators that deliver up to 4A of load current. The regulators support a wide input supply (0.9V to 5.5V) and BIAS (2.7V to 20V) voltage ranges, making them suitable for variety of applications. The output voltage regulation accuracy of  $\pm 1\%$  is maintained across load, line, and temperature variations, requiring only 300mV of input-to-output headroom at full load for good PSRR. The output voltage can be adjusted to a value in the range of 0.6V to 5.0V to accommodate customers that desire to specify a single LDO in the BOM for multiple voltage rails.

The MAX38907 is configurable to one of 27 output voltages using three digital configuration pins. In addition, each output voltage selection can be adjusted  $\pm 5\%$  for margining. The output voltage on the MAX38908 can be adjusted to a value in the range of 0.6V to 5.0V by using two external feedback resistors. These LDOs are fully protected from damage by internal circuitry that provides programmable inrush current limiting, output overcurrent limiting, reverse-current limiting, and thermal overload protection.

### Enable

The MAX38907/MAX38908 includes an enable pin (EN). The enable signal is an active-high digital signal that enables the device when its voltage passes the rising threshold ( $V_{EN} \geq V_{IH} (EN)$ ) and disables the device when its voltage is below the falling threshold ( $V_{EN} \leq V_{IL} (EN)$ ). If a separate shutdown signal is not available, connect EN to BIAS. When EN is driven by a host, its bias current will vary with the BIAS supply level. See the [Typical Operating Characteristics](#) for more information.

### Bypass

The capacitor connected from BYP to OUT filters noise at the reference, feedback resistors, and regulator input stage. It provides a high-speed feedback path for improved transient response. A 10nF capacitor rolls off noise at around 32Hz.

The slew rate of the output voltage during startup is also determined by the BYP capacitor. The MAX38907/MAX38908 feature programmable, monotonic, soft-start set by this capacitor. Its use is highly recommended to minimize inrush current into the output capacitor. A 10nF capacitor sets the slew rate to 5V/ms. This startup rate results in a 110mA slew current drawn from the input at startup to charge 22 $\mu$ F output capacitance.

The BYP capacitor value can be adjusted from 1nF to 100nF to change the startup slew rate according to the following formula:

$$\text{Startup Slew Rate} = 5\text{V/ms} \times 10\text{nF}/C_{\text{BYP}}$$

where  $C_{\text{BYP}}$  is in nF.

This slew rate applies until  $V_{\text{OUT}}$  reaches 75% of the target, after which  $V_{\text{OUT}}$  slew rate is reduced.

Also, note that being a low-frequency filter node, BYP is sensitive to leakage. BYP leakage currents above 10nA cause measurable inaccuracy at the output and should be avoided.

### Power OK

The power-OK (POK) function monitors the voltage at the feedback pin to indicate the output voltage is in regulation. Its operation versus the output voltage is shown in [Figure 1](#).

The POK pin is open-drain and requires a pullup resistor to an external supply in order to properly report the device regulation status to other devices so it can be used for sequencing. Check if the external pullup supply voltage results in a valid logic level for the receiving device or devices.

The range of the pullup resistance is between 10k $\Omega$  and 100k $\Omega$ . Its lower limit comes from the pulldown strength of the POK transistor, while the higher limit is determined by maximum leakage current at the POK pin.

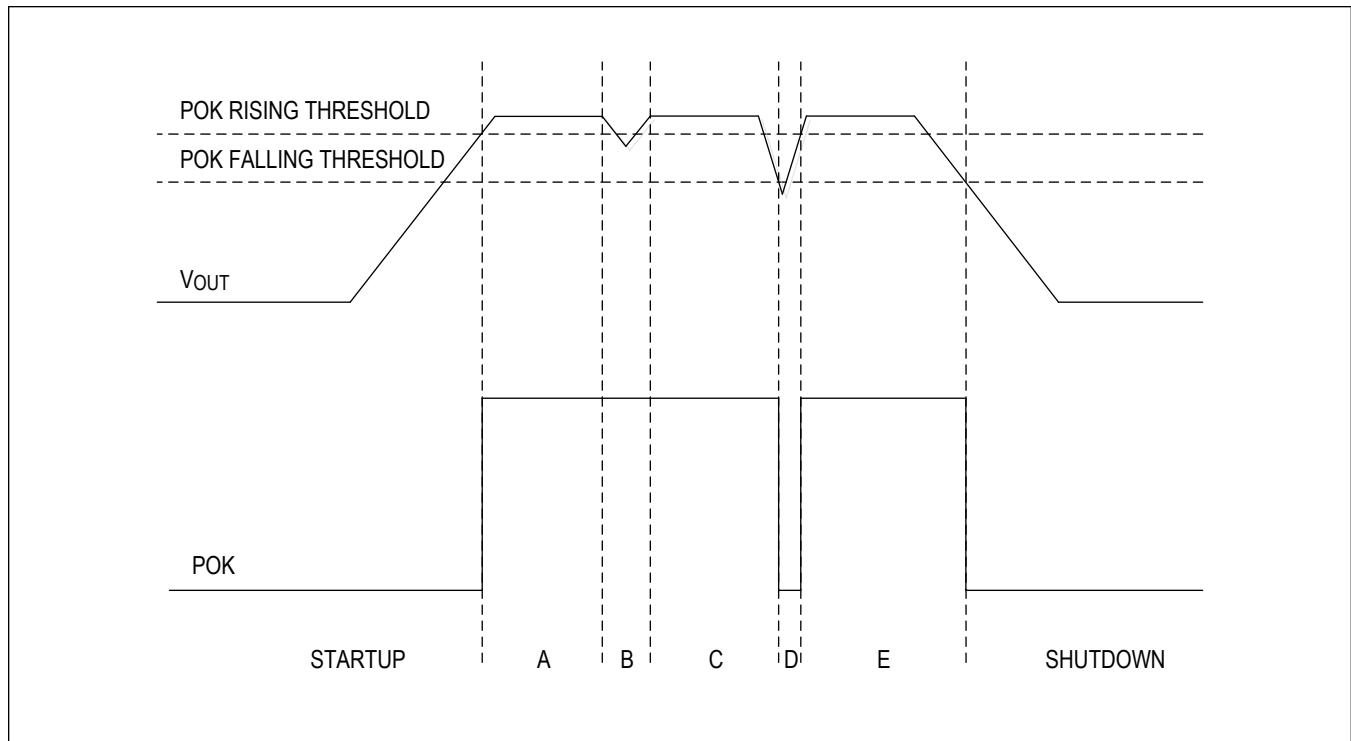

Figure 1. Typical POK Operation

The POK operation versus the output voltage is shown in [Figure 1](#). Different operating regions are:

- A - The device is in regulation.
- B -  $V_{OUT}$  sags but does not reach the POK falling threshold.
- C - The device is in regulation.
- D -  $V_{OUT}$  sags low enough to cross the POK falling threshold. The POK is driven low until  $V_{OUT}$  recovers above the POK rising threshold.
- E - The device is in regulation.

### Protection

The MAX38907/MAX38908 is fully protected from an output short-circuit by a current-limiting and thermal overload protection circuit. If the output is shorted to GND, the output current is limited to 5.6A (typ). Under these conditions, the device quickly heats up. When the junction temperature reaches +165°C, a thermal limit circuit shuts the output device off. Once the device cools to +150°C, the output turns back on to reestablish regulation. If the fault persists, the output current cycles on and off as the junction temperature slews between +150°C and +165°C. Continuously operating in the fault conditions or above +125°C junction temperature is not recommended since long-term reliability may be reduced. In dropout, the current limit will trigger at 7.4A (typ). Once the limit is triggered, the device will limit the current to 5.6A (typ).

The thermal protection can also be triggered when the device is exposed to excessive heat in the system causing the die temperature to reach undesired levels.

The MAX38907/MAX38908 provides the reverse-current protection when the output voltage is higher than the input. If extra output capacitance is used at the output, a power-down transient at the input would normally cause a large reverse-current through a conventional regulator. The MAX38907/MAX38908 include a reverse-voltage detector that trips when IN drops 6.5mV below OUT, shutting off the regulator and opening the body diode connection, thus preventing any reverse current. The reverse current is a current that flows through the body diode of the pass element and is undesired due to its impact on power dissipation and long-term reliability, especially at higher current levels. The conditions where the reverse current can be flowing back to IN are:

- If the device has a large  $C_{OUT}$  and the input supply collapses quickly;  $O_{UT}$  has little or no-load current,
- The output is biased when the input supply is not established, or
- The output is biased above the input supply.

The MAX38907/MAX38908 will block reverse currents that exceed about 0.7A by opening a switch in series with the pass device body diode.

### Undervoltage Lockout (UVLO)

The MAX38907/MAX38908 undervoltage lockout (UVLO) circuits respond quickly to glitches on  $I_N$  or  $B I A S$  and attempts to disable the output of the device if either of these rails collapse. The local input capacitance prevents transient brownouts in most applications.

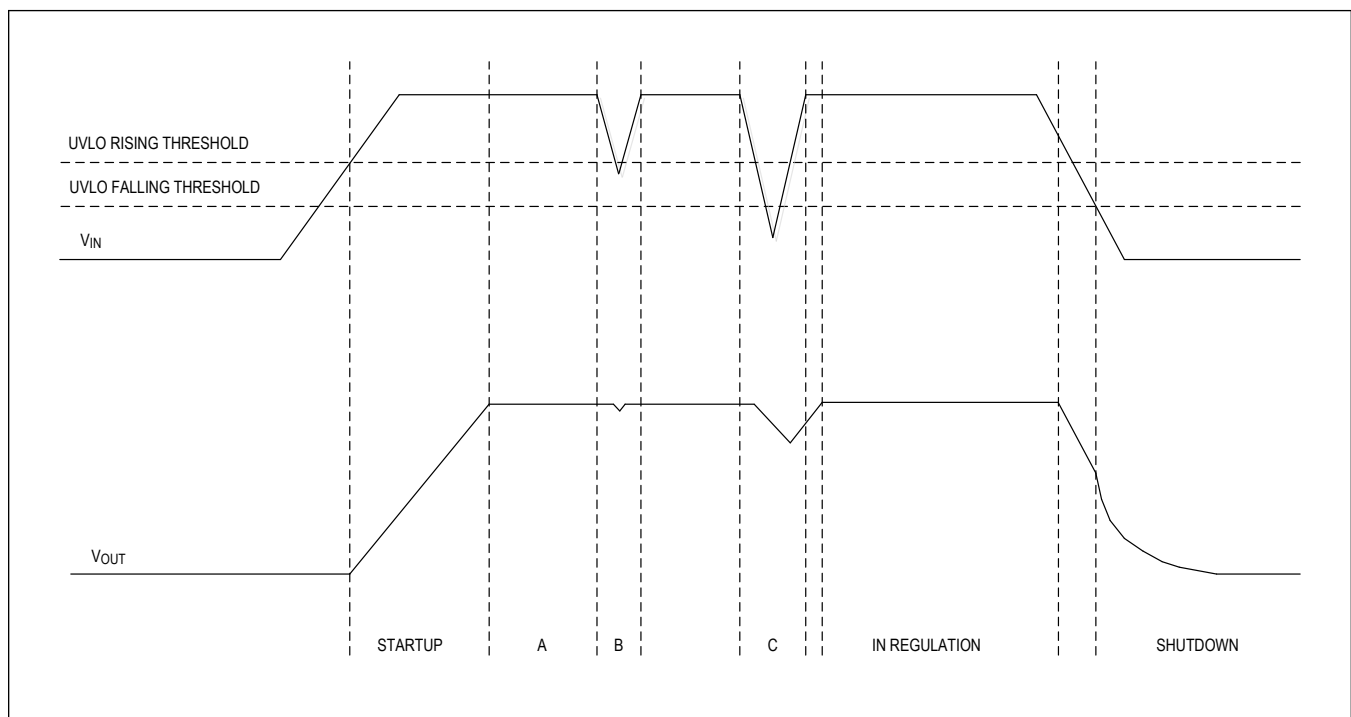

Figure 2. Typical  $I_N$  UVLO Operation

Figure 2 reflects UVLO operation. The different operation regions are:

- **STARTUP** - The device begins soft-start once the input voltage crosses its UVLO rising threshold, providing the  $B I A S$  voltage is already above its UVLO rising threshold and the device is enabled ( $V_{EN} > V_{IH}$ ).
- **A** - The device is in regulation.
- **B** - An input supply brownout condition where  $V_{IN}$  can sag below the UVLO rising threshold, but not below the falling threshold. The device is enabled. Note that the output will sag once the device is in dropout.
- **C** - An input supply brownout condition where  $V_{IN}$  sags below UVLO falling threshold. The device is disabled when  $V_{IN}$  crosses its UVLO falling threshold.  $V_{O_{UT}}$  drops due to load current. The regulator gets enabled again once  $V_{IN}$  recovers to the UVLO rising threshold. Note that the output will start to sag once the device is in dropout.
- **SHUTDOWN** - The output voltage will start to ramp down once the device gets into dropout. It gets disabled when the input voltage drops below its UVLO falling threshold.

During  $V_{IN}$  power-up, the MAX38907/MAX38908 will begin  $V_{O_{UT}}$  soft start-after  $V_{IN}$  crosses the  $V_{IN}$  UVLO rising threshold. This assures proper  $V_{O_{UT}}$  ramp up and transition to regulation.  $V_{O_{UT}}$  soft-start rate should be kept at or slower than the  $V_{IN}$  slew rate to avoid entering the dropout. In some situations,  $V_{IN}$  transients can place the regulator

into dropout. As  $V_{IN}$  starts climbing again and the device comes out of the dropout, the output can overshoot, as shown in [Figure 3](#). This condition is avoided by using an enable signal or by increasing the soft-start time with a larger  $C_{BYP}$ .

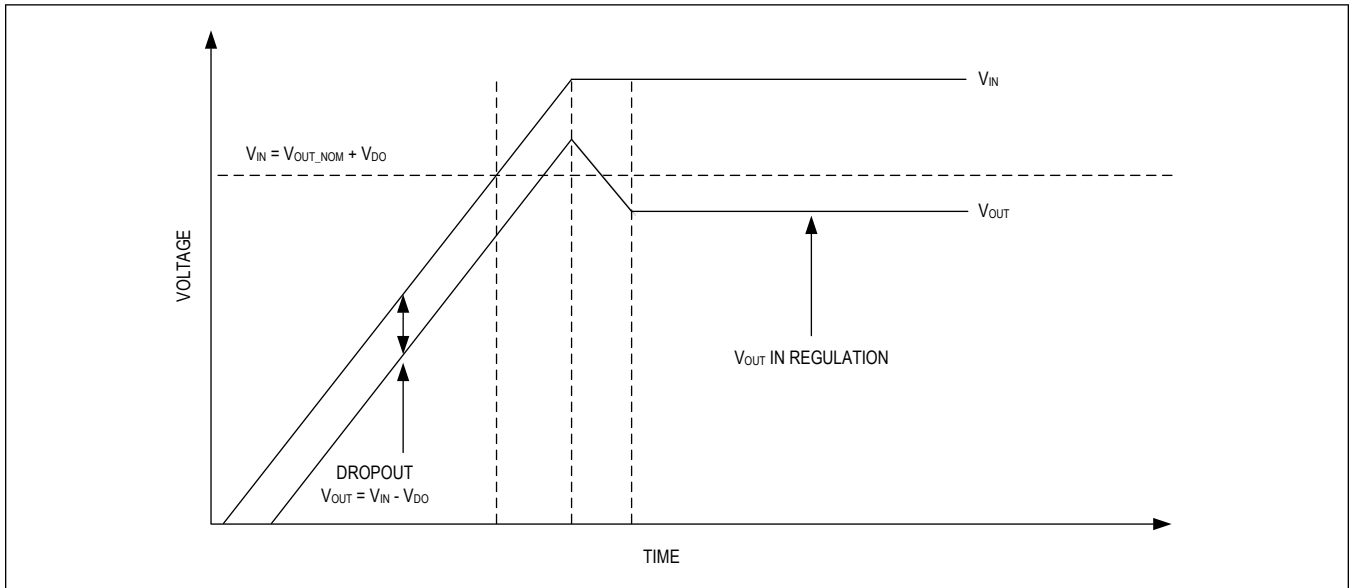

Figure 3. Startup into Dropout

### Active Discharge

When EN is low or BIAS supply is below its falling UVLO threshold, the MAX38907/MAX38908 connects a 70Ω resistor from  $V_{OUT}$  to GND in order to discharge the output capacitance.

### Output Voltage Selection

#### Select Version

The MAX38907 includes configuration pins SELA, SELB, and SELC that are read during power-up to determine the output regulation voltage. 27 output voltage settings are available. [Table 1](#) lists the MAX38907  $V_{OUT}$  configuration options.

In addition, the MAX38907 has an additional pin, MRG, which allows the output voltage to be margined to ±5% with respect to each selection option. The MRG pin is strapped low or high in the system, or it can be driven dynamically by the host. Note that the MRG pin cannot be directly strapped to the BIAS supply if the supply is above 5.0V.

**Table 1. MAX38907 Output Voltage Configuration**

SELA	SELB	SELC	NOMINAL $V_{OUT}$ (V)	$V_{OUT}$ AT MRG LOW (V)	$V_{OUT}$ AT MRG HIGH (V)
Float	Float	Float	0.6	0.57	0.63
GND	Float	Float	0.65	0.6175	0.6825
BIAS	Float	Float	0.7	0.665	0.735
Float	GND	Float	0.75	0.7125	0.7875
GND	GND	Float	0.8	0.76	0.84
BIAS	GND	Float	0.85	0.8075	0.8925
Float	BIAS	Float	0.9	0.855	0.945
GND	BIAS	Float	0.95	0.9025	0.9975
BIAS	BIAS	Float	1.0	0.95	1.05

**Table 1. MAX38907 Output Voltage Configuration (continued)**

Float	Float	GND	1.05	0.9975	1.1025
GND	Float	GND	1.1	1.045	1.155
BIAS	Float	GND	1.15	1.0925	1.2075
Float	GND	GND	1.2	1.14	1.26
GND	GND	GND	1.25	1.1875	1.3125
BIAS	GND	GND	1.3	1.235	1.365
Float	BIAS	GND	1.5	1.425	1.575
GND	BIAS	GND	1.8	1.71	1.89
BIAS	BIAS	GND	2.0	1.9	2.1
Float	Float	BIAS	2.2	2.09	2.31
GND	Float	BIAS	2.5	2.375	2.625
BIAS	Float	BIAS	2.7	2.565	2.835
Float	GND	BIAS	3.0	2.85	3.15
GND	GND	BIAS	3.3	3.135	3.465
BIAS	GND	BIAS	3.6	3.42	3.78
Float	BIAS	BIAS	4.0	3.8	4.2
GND	BIAS	BIAS	4.5	4.275	4.725
BIAS	BIAS	BIAS	5.0	4.75	5.25

**Feedback Version**

The MAX38908 uses external feedback resistors to set the output regulation voltage. The output voltage can be set from 0.6V to 5.0V. Set the bottom feedback resistor R1 to less than 100kΩ to minimize FB input bias current error. Calculate the value of the top feedback resistor R2 as follows:

$$R2 = R1 \times (V_{OUT}/V_{FB} - 1)$$

where  $V_{FB}$  is the feedback regulation voltage of 0.6V.

To set the output to 1.0V, for example, R2 should be:

$$R2 = 15k\Omega \times (1.0V/0.6V - 1) = 10k\Omega$$

An R1 of 15kΩ is recommended to optimize noise performance.

Values of the resistor-divider and its tolerance will have a direct impact to  $V_{OUT}$  accuracy. 1% resistors or better are recommended. [Table 2](#) shows recommended values for the feedback resistors.

**Table 2. Recommended Feedback Resistor Values**

TARGETED OUTPUT VOLTAGE (V)	TOP FEEDBACK RESISTOR VALUES (kΩ)	BOTTOM FEEDBACK RESISTOR VALUES (kΩ)	CALCULATED OUTPUT VOLTAGE (V)
0.8	4.99	15.0	0.799
0.9	7.50	15.0	0.900
1.0	10.0	15.0	1.0
1.2	15.0	15.0	1.2
1.5	22.6	15.0	1.504
1.8	30.1	15.0	1.804
2.5	47.5	15.0	2.5
2.7	52.3	15.0	2.692

**Table 2. Recommended Feedback Resistor Values (continued)**

3.0	59.0	14.7	3.008
3.3	68.1	15.0	3.324
3.6	75.0	15.0	3.6
4.5	97.6	15.0	4.504
5.0	110.0	15.0	5.0

## Applications Information

### Input and Output Capacitors

The MAX38907/MAX38908 are designed to have stable operation using low equivalent series resistance (ESR) ceramic capacitors at the input, output, and bypass pins. Multilayer ceramic capacitors (MLCC) with X7R dielectric are commonly used for these types of applications and are recommended due to their relatively stable capacitance across temperature. Nevertheless, amount of equivalent capacitance will depend on operating DC voltage, AC voltage ripple, temperature, etc. Therefore, the capacitor data sheet needs to be properly examined.

The MAX38907/MAX38908 are designed and characterized for operation with X7R ceramic capacitors of 22 $\mu$ F or greater (10 $\mu$ F or greater of effective capacitance), both at the input and output. These capacitors must be placed as close as possible to the respective input and output pins to minimize trace parasitics.

A combination of multiple output capacitors in parallel will boost the high-frequency PSRR.

### Thermal Design

In order to optimize MAX38907/MAX38908 performance, special consideration is given to the device power dissipation and PCB thermal design. Power dissipation in the regulator depends on the input-to-output voltage difference and load conditions. It can be calculated by following equation:

$$\text{Loss (W)} = (V_{\text{IN}} - V_{\text{OUT}}) \times I_{\text{LOAD}}$$

Optimal power dissipation can be achieved by carefully choosing input voltage for a given output target rail voltage.

The main thermal conduction path for the device is through the exposed pad of the package. As a result, the thermal pad must be soldered to a copper pad area under the device. Thermal-plated vias must be placed inside the thermal PCB pad to transfer heat to different GND layers in the system. The vias should be capped to minimize solder voids. The maximum power dissipation is determined by using thermal resistance from the device junction to ambient, keeping the maximum junction temperature below +125°C. Thermal properties of the package are given in the [Package Information](#) section.

The first-order power dissipation estimate for a condition of 3.3V IN and 2.5V OUT with a load current of 500mA is:

$$\text{Loss (W)} = (V_{\text{IN}} - V_{\text{OUT}}) \times I_{\text{LOAD}} = (3.3\text{V} - 2.5\text{V}) \times 0.5\text{A} = 0.4\text{W}$$

Assuming the MAX38908ATD+, this power dissipation will raise the junction temperature to:

$$T_{\text{J}} = (\text{PD} \times \theta_{\text{JA}}) + 25^{\circ}\text{C} = (0.4\text{W} \times 41^{\circ}\text{C/W}) + 25^{\circ}\text{C} = 41.4^{\circ}\text{C}$$

## Ordering Information

PART NUMBER	TEMPERATURE RANGE	PIN-PACKAGE	FEATURES
MAX38907ATP+	-40°C to +125°C	20-pin, 5mm x 5mm TQFN	4A LDO, enable input, digitally programmable output voltage, adjustable margin, low-noise bypass
MAX38908ATD+	-40°C to +125°C	14-pin, 3mm x 3mm TDFN	4A LDO, enable input, externally adjustable output, low-noise bypass
MAX38908ANL+	-40°C to +125°C	5 x 3 bump, 0.4mm pitch WLP	4A LDO, enable input, externally adjustable output, low-noise bypass

+ Denotes a lead(Pb)-free/RoHS-compliant package.



**Revision History**

<b>REVISION NUMBER</b>	<b>REVISION DATE</b>	<b>DESCRIPTION</b>	<b>PAGES CHANGED</b>
0	7/19	Initial release	—
1	2/20	Removed MAX38909 from data sheet, added more <i>Typical Operating Characteristics</i>	1–23
2	11/20	Updated <i>General Description, Benefits and Features, Typical Application Circuits, Absolute Maximum Ratings, Electrical Characteristics, Pin Configurations, Functional Diagram, Detailed Description, Applications Information, Ordering Information</i>	1, 2, 6–9, 13, 17, 18, 24

For pricing, delivery, and ordering information, please visit Maxim Integrated's online storefront at <https://www.maximintegrated.com/en/storefront/storefront.html>.

*Maxim Integrated cannot assume responsibility for use of any circuitry other than circuitry entirely embodied in a Maxim Integrated product. No circuit patent licenses are implied. Maxim Integrated reserves the right to change the circuitry and specifications without notice at any time. The parametric values (min and max limits) shown in the Electrical Characteristics table are guaranteed. Other parametric values quoted in this data sheet are provided for guidance.*