

The Reliable Source ...

FERROPERM

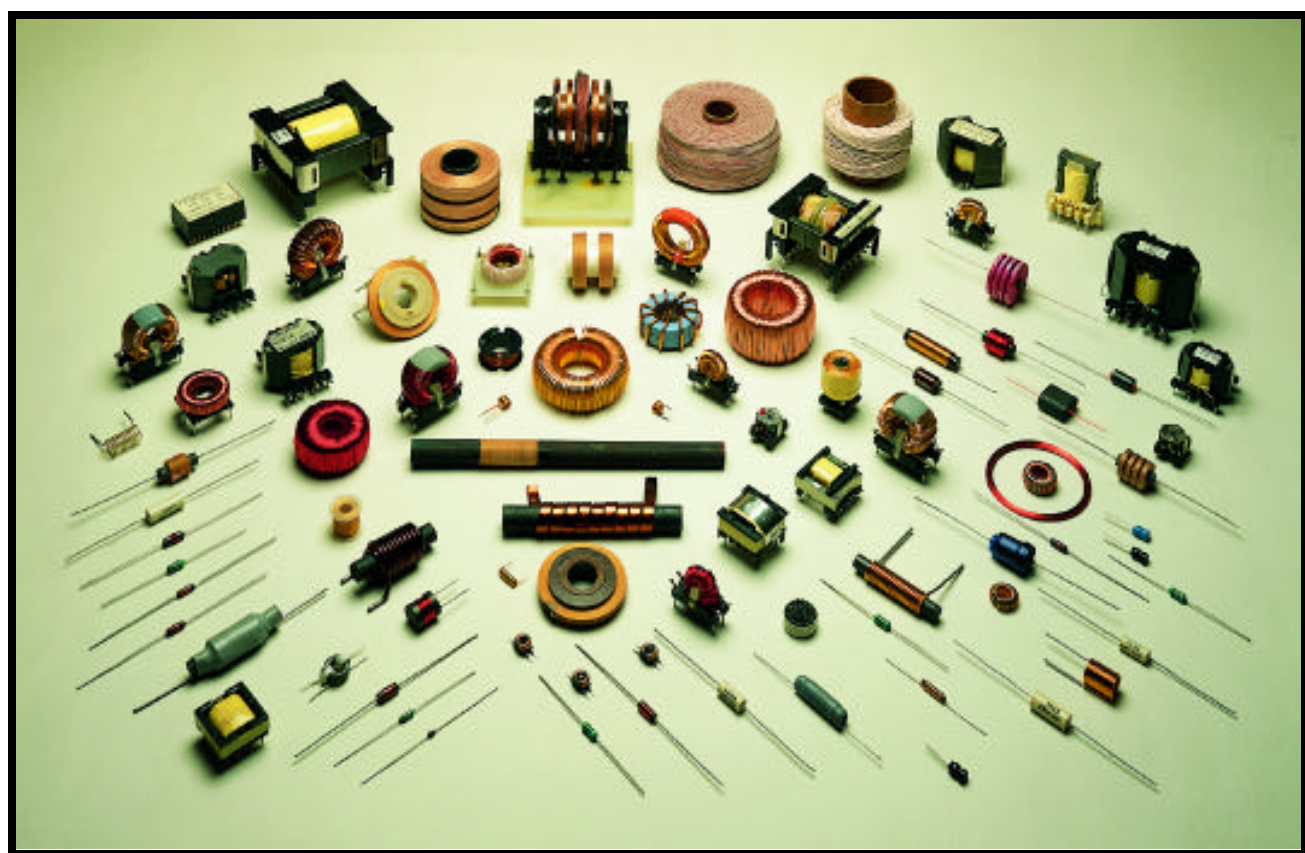

for High Quality



Inductors and



Transformers

INDUCTORS AND TRANSFORMERS

from FERROPERM UK Ltd.

FERROPERM offers a manufacturing capability for the production of most types of high quality inductors and transformers, including surface mounting types. Toroidal types and wave-wound types are particular specialities.

Transformers are all produced as custom designs (see page 16). Inductors are produced as custom designs (see page 15) and in standard ranges which are presented in this catalogue.

A highly flexible production facility ensures short lead times on custom designs as well as standard products. We can produce designs for your applications or we can manufacture to your own designs.

Rather than trying to list all the types of inductors and transformers FERROPERM can produce, it is easier to list types not made:

1. ``Mains" (50 or 60Hz) power transformers.
2. Inductors and transformers with any dimension larger than about 300 mm.

FERROPERM

TYPE 1580

RADIO-FREQUENCY CHOKES

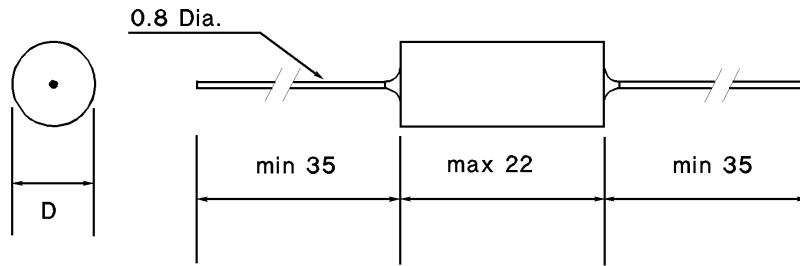

Dimensions in mm.

Core Low-loss Iron Powder
 Coating Insulated with heat-shrink tube
 Load on Terminals 2Kg max
 Working Temperature -55 to +85°C ambient
 Marking Type and inductance

Inductance μH (±10%)	Maximum Rdc Ω		Idc A Max	Fr MHz Typ	D mm Max
	@ 25°C	@ 85°C			
10 *	0.3	0.4	0.9	36.0	8.0
16	0.7	0.9	0.6	32.0	8.0
25 *	0.9	1.1	0.6	27.0	8.0
40	1.3	1.7	0.5	18.0	8.0
50	1.6	2.0	0.5	16.0	8.0
63	1.7	2.2	0.5	14.0	8.5
80	1.9	2.4	0.4	13.0	8.5
100 *	2.0	2.6	0.4	10.0	8.5
125	2.3	2.9	0.4	10.0	8.5
160	2.6	3.3	0.4	9.0	9.0
200	3.0	3.8	0.3	8.0	9.0
250 *	3.4	4.3	0.3	7.0	9.0
315	3.9	4.9	0.3	5.5	9.0
400	4.5	5.6	0.2	5.0	9.0
500 *	5.2	6.5	0.2	5.5	9.0

* Preferred values

Idc max: Maximum Current at 85°C ambient

For other temperatures use the "Load Ratings" curve 1 on page 17

To order these chokes please specify type 1580 and the inductance value.

FERROPERM

TYPE 1582

RADIO-FREQUENCY CHOKES

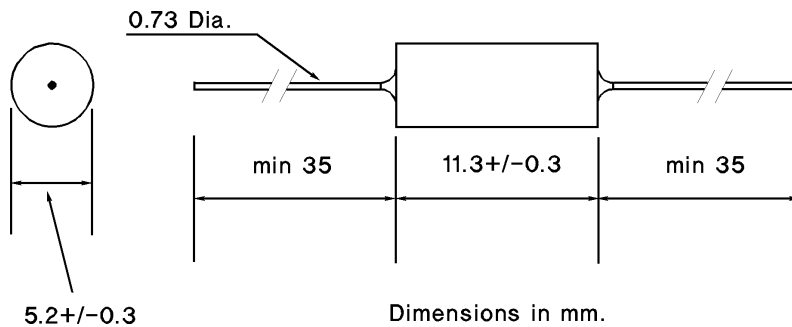

- Core Thermoset Plastic up to 0.68μH
Low-loss Ferrite above 0.68μH
- Coating Moulded Polypropylene
- Load on Terminals 2Kg max
- Working Temperature -55 to +85°C ambient
- Marking Type, inductance and current

Inductance μH (±10%)	Q	@	Fr MHz	Rdc Ω	Idc A
	Typ	F MHz	Typ	Typ	Max
0.10	65	25	>400	0.025	3.0
0.15	65	25	>400	0.035	2.5
0.22	55	25	>400	0.045	2.0
0.33	55	25	350	0.055	2.0
0.47	55	25	320	0.07	1.7
0.68	45	15	290	0.09	1.5
1.0	45	15	190	0.04	2.2
1.5	65	8.0	155	0.05	2.0
2.2	60	8.0	130	0.06	1.8
3.3	50	8.0	110	0.07	1.7
4.7	50	8.0	95	0.12	1.3
6.8	60	8.0	85	0.22	1.0
10	50	8.0	65	0.35	0.75
15	55	2.5	55	0.6	0.6
22	65	2.5	45	1.1	0.43
33	85	2.5	35	2.0	0.3
47	70	2.5	20	2.5	0.27
68	65	2.5	16	3.0	0.25
100	65	1.5	14	4.0	0.22
150	80	0.8	9.5	5.8	0.23
220	80	0.8	8.0	7.3	0.2
330	80	0.8	9.5	12	1.16
470	80	0.8	6.5	20	0.12
680	85	0.8	5.0	24	0.11
1000	85	0.8	3.0	30	0.1

Idc max: Maximum Current at 85°C ambient

For other temperatures use the "Load Ratings" curve 2 on page 17

To order these chokes please specify type 1582 and the inductance value.

FERROPERM

TYPE 1583

RADIO-FREQUENCY CHOKES

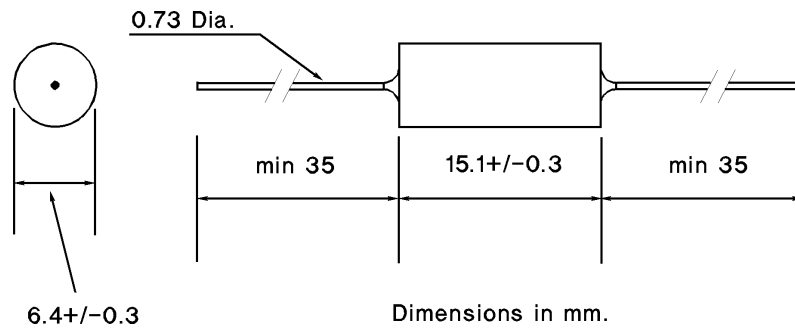

Core Low-loss Ferrite
 Coating Moulded Polypropylene
 Load on Terminals 2Kg max
 Working Temperature -55 to +85°C ambient
 Marking Type, inductance and current

Inductance μH (±10%)	Q	@	Fr MHz	Rdc Ω	Idc A
	Typ	F MHz	Typ	Typ	Max
1.0	90	8.0	200	0.015	3.0
1.5	85	8.0	160	0.02	3.0
2.2	75	8.0	140	0.025	3.0
3.3	55	8.0	120	0.035	3.0
4.7	40	8.0	100	0.04	2.7
6.8	40	8.0	85	0.07	2.0
10	50	8.0	70	0.16	1.25
15	50	2.5	55	0.32	1.0
22	50	2.5	45	0.54	0.75
33	60	2.5	35	0.85	0.6
47	80	2.5	32	1.5	0.45
68	100	2.5	25	2.7	0.3
100	60	0.8	15	1.8	0.4
150	70	0.8	12	3.6	0.3
220	70	0.8	11	4.3	0.25
330	75	0.8	8	8.3	0.2
470	80	0.8	8	10	0.17
680	80	0.8	6	16	0.14
1000	70	0.5	5	20	0.12

Idc max: Maximum Current at 85°C ambient

For other temperatures use the "Load Ratings" curve 2 on page 17

To order these chokes please specify type 1583 and the inductance value.

FERROPERM

TYPE 1585

INTERFERENCE SUPPRESSION CHOKES

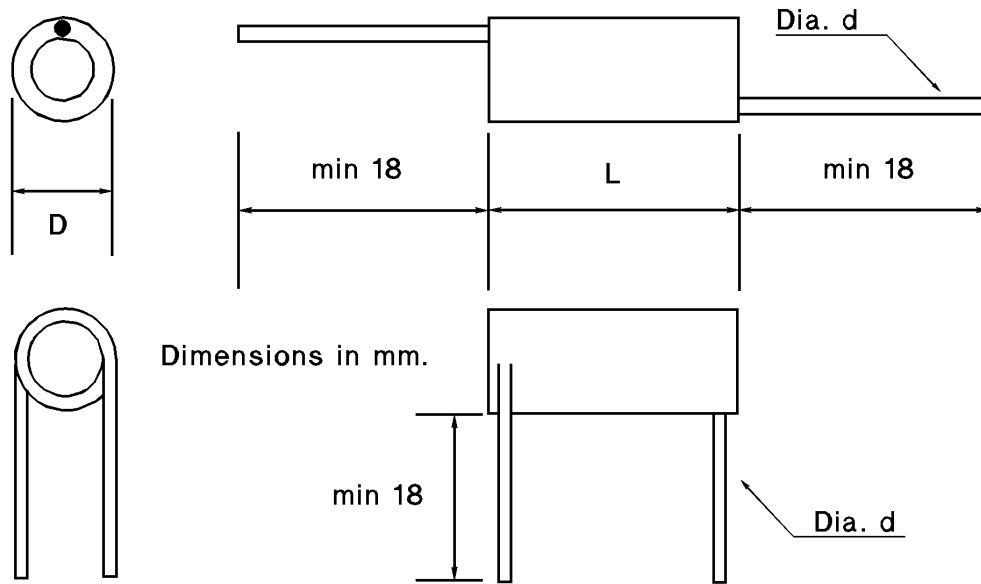

INS (insulated) types only have axial leads: see top drawing.

LAC (lacquered) types can have axial or radial leads: see top drawing for axial style
see bottom drawing for radial style

Core	Ferrite
Coating (LAC types)	Polyurethane Lacquer
Coating (INS types)	Insulated with heat-shrink tube
Working Temperature	-55 to +85°C ambient
Marking (LAC types)	None
Marking (INS types)	Type, inductance and current

Idc max: Maximum Current at 85°C ambient

For other temperatures use the "Load Ratings" curves on page 17

Curve 1 for INS types and Curve 2 for LAC types

For dimensions see next page

To order these chokes please specify type 1585 and the inductance value, current rating and type.

e.g. "1585 10µH 3A LAC" or "1585 25µH 6A INS"

Axial leads will be supplied unless radial are specified. Radial are only available on LAC types.

FERROPERM

TYPE 1585

INTERFERENCE SUPPRESSION CHOKES

Inductance μH ($\pm 20\%$)	Maximum Idc A		Rdc $\text{m}\Omega$	Fr MHz	Dimensions in mm *			
	LAC	INS	Typ	Typ	D	x	L	d
4	2	1.5	35	140	3	x	11	0.35
6			38	110	3	x	15	0.4
10			43	90	3	x	30	0.4
15			70	65	5	x	20	0.4
25			110	45	6	x	20	0.35
4	3	2	18	130	3	x	15	0.5
6			20	95	3	x	20	0.5
10			38	70	5	x	20	0.5
15			50	45	6	x	20	0.5
25			68	45	7	x	22	0.5
4	4	3	13	110	3.5	x	20	0.63
6			20	90	5.5	x	20	0.63
10			25	70	6.5	x	20	0.63
15			37	55	7.5	x	22	0.63
25			45	40	7.5	x	30	0.63
50			60	3	10.5	x	22	0.63
100			90	2.5	10.5	x	22	0.63
500			200	1	14	x	40	0.63
1000			350	0.6	15.5	x	42	0.63
4	6	4	10	100	6	x	20	0.8
6			13	80	7	x	20	0.8
10			16	70	8	x	22	0.8
15			20	55	8	x	30	0.8
25			25	45	8	x	35	0.8
4	8	6	8	110	7.5	x	20	0.95
6			9.5	80	8.5	x	22	0.95
10			12	65	8.5	x	30	0.95
15			15	55	8.5	x	35	0.95
25			19	45	8.5	x	40	0.95

* D & L are maximum dimensions for LAC types. Please add 1mm to D and 5mm to L for maximum dimensions for INS types.

Dimension d values are nominal wire diameters.

FERROPERM

TYPE 15EC24

GENERAL PURPOSE INDUCTORS

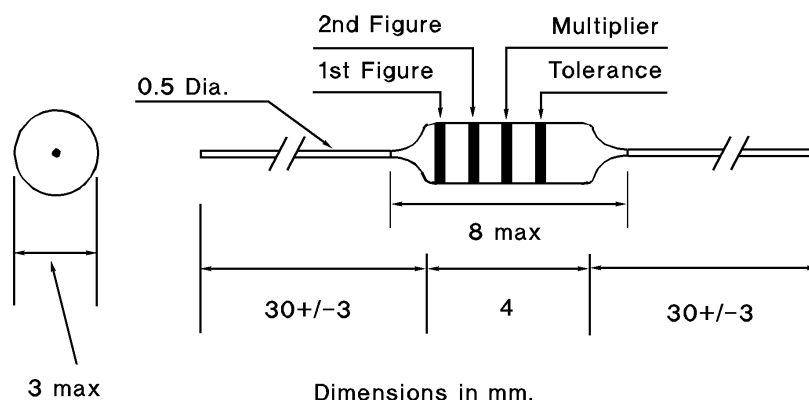

Core Ferrite
 Coating Epoxy
 Insulation withstand voltage 250V a.c.
 Load on Terminals 1Kg max
 Working Temperature -55 to +85°C ambient
 Marking Standard colour banding
 (Base unit 1µH)

Inductance µH	Q		@	Fr MHz	Rdc Ω	Idc mA
	Min		F MHz	Min	Max	Max
0.22 ±20%	40		25.2	380	0.08	1150
0.47 ±20%	40		25.2	300	0.1	1000
1.0 ±10%	40		25.2	180	0.15	815
2.2 ±10%	50		7.96	110	0.25	630
4.7 ±10%	45		7.96	50	0.35	530
10 ±10%	40		7.96	22	0.72	370
22 ±10%	50		2.52	13	1.2	385
47 ±10%	60		2.52	8.5	2.3	205
100 ±10%	60		2.52	5.5	3.5	165
220 ±10%	60		0.796	4.0	5.7	130
470 ±10%	60		0.796	2.5	11.6	90
1000 ±10%	60		0.796	1.1	30	60

To order these chokes please specify type 15EC24 and the inductance value.

Certain other inductance values are available to special order. Please contact our Sales Office with your requirements.

Examples of colour banding:-

	1st Fig	2nd Fig	Multiplier	Tolerance
15EC24 u47M	Yellow	Purple	Silver	Black
15EC24 m22K	Red	Red	Brown	Silver

FERROPERM

TYPE 15EC36

GENERAL PURPOSE INDUCTORS

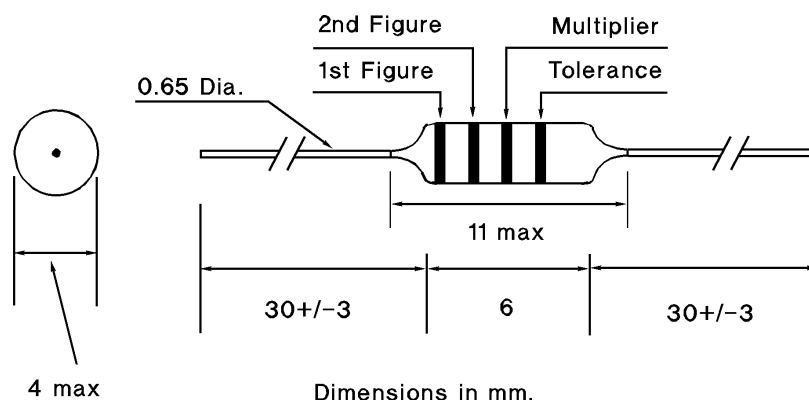

Core Ferrite
 Coating Epoxy
 Insulation withstand voltage 250V a.c.
 Load on Terminals 1Kg max
 Working Temperature -55 to +85°C ambient
 Marking Standard colour banding
 (Base unit 1µH)

Inductance µH	Q	@	Fr MHz	Rdc Ω	Idc mA
	Min	F MHz	Min	Max	Max
0.22 ±20%	25	25.2	380	0.21	880
0.47 ±20%	25	25.2	250	0.36	650
1.0 ±10%	45	25.2	157	0.19	920
2.2 ±10%	55	7.96	110	0.28	750
4.7 ±10%	70	7.96	80	0.39	620
10 ±10%	85	7.96	45	0.58	500
22 ±10%	60	2.52	9.9	0.84	410
47 ±10%	45	2.52	6.3	1.22	340
100 ±10%	30	2.52	4.8	1.8	275
220 ±10%	70	0.796	3.0	5.1	155
470 ±10%	60	0.796	2.3	7.7	126
1000 ±10%	50	0.796	1.4	14	100

To order these chokes please specify type 15EC36 and the inductance value.

Certain other inductance values are available to special order. Please contact our Sales Office with your requirements.

Examples of colour banding:-

	1st Fig	2nd Fig	Multiplier	Tolerance
15EC36 u47M	Yellow	Purple	Silver	Black
15EC35 m22K	Red	Red	Brown	Silver

FERROPERM

TYPE 1588

RADIO-FREQUENCY CHOKES

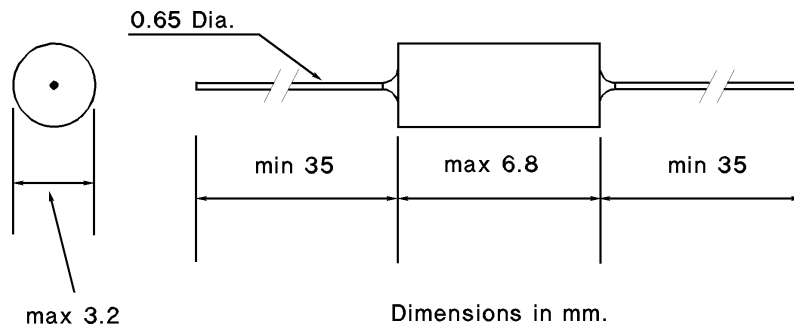

Core Thermoset Plastic up to 1.0 μ H
 Low-loss Ferrite above 1.0 μ H

Coating Polyurethane Lacquer

Load on Terminals 2Kg max

Working Temperature -55 to +85°C ambient

Marking Type and inductance

Inductance μ H ($\pm 10\%$)	Q	@	Fr MHz	Rdc Ω	Idc A
	Typ	F MHz	Typ	Typ	Max
0.1	50	25	680	0.1	1.3
0.15	50	25	600	0.13	1.1
0.22	50	25	510	0.16	1.0
0.33	50	25	410	0.18	0.9
0.47	50	25	330	0.28	0.8
0.68	50	25	280	0.3	0.75
1.0	50	25	250	0.42	0.65
1.5	70	8.0	150	0.25	0.8
2.2	70	8.0	125	0.3	0.75
3.3	60	8.0	100	0.35	0.7
4.7	65	8.0	85	0.5	0.6
6.8	70	8.0	70	1.1	0.4
10	70	8.0	60	1.8	0.3
15	60	2.5	45	2.6	0.25
22	50	2.5	35	5	0.18
33	60	2.5	25	6.2	0.16
47	65	2.5	21	7.5	0.15
68	70	2.5	17	8.5	0.14
100	70	2.5	13	11.5	0.12

Idc max: Maximum Current at 85°C ambient

For other temperatures use the "Load Ratings" curve 2 on page 17

To order these chokes please specify type 1588 and the inductance value.

FERROPERM

Type 1586

INTERFERENCE SUPPRESSION CHOKES

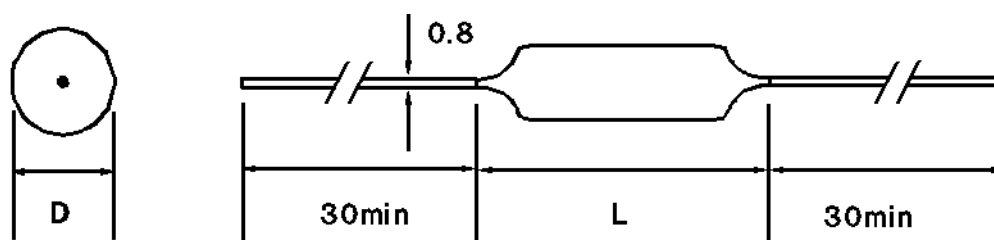

Dimensions in mm.

Core Ferrite.
 Coating Insulated with heat-shrink tube.
 Working Temperature -55 to +85 °C ambient.
 Marking Type, inductance and current.

Inductance uH ($\pm 20\%$)	Idc max. A	Rdc Typ. milliOhms	Fr Typ. MHz	Dimensions D x L
5.6	8	17	83	8 x 26
10	5	35	65	7.5 x 26
15	4	50	55	7.3 x 26
33	3.5	70	7	11 x 26
68	3	100	5	11 x 26
100	2.5	150	3.5	10 x 26
150	1.8	300	2.5	9.8 x 26
330	1.4	500	2	11 x 26
680	1	1000	1.1	10 x 26
1000	0.8	1500	0.85	9.8 x 26
1500	0.7	2000	0.79	10.3 x 26
3300	0.5	4000	0.46	10.6 x 26
6800	0.35	8000	0.36	10.8 x 26
10000	0.3	12000	0.25	9.8 x 26

Imax: Maximum current at 40 °C ambient.

For other temperatures use the "Load Ratings" curve 3 shown on page 17.

To order these chokes please specify type 1586, the inductance value and the current rating. e.g. "1586 10 μ H 5A".

Dimension are in mm and are nominal values.

FERROPERM

Types 15SC137, 177, 178,

COMMON MODE SUPPRESSION CHOKES

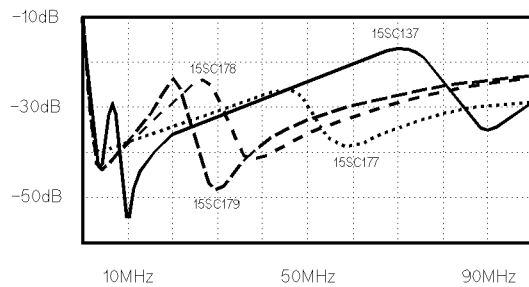
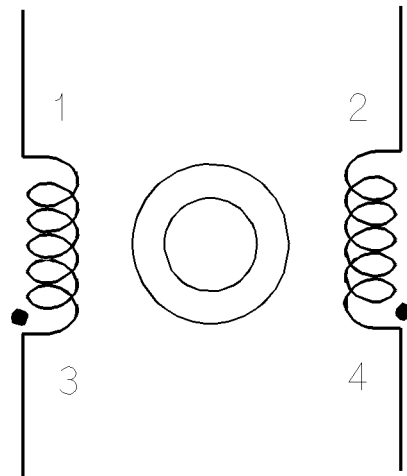
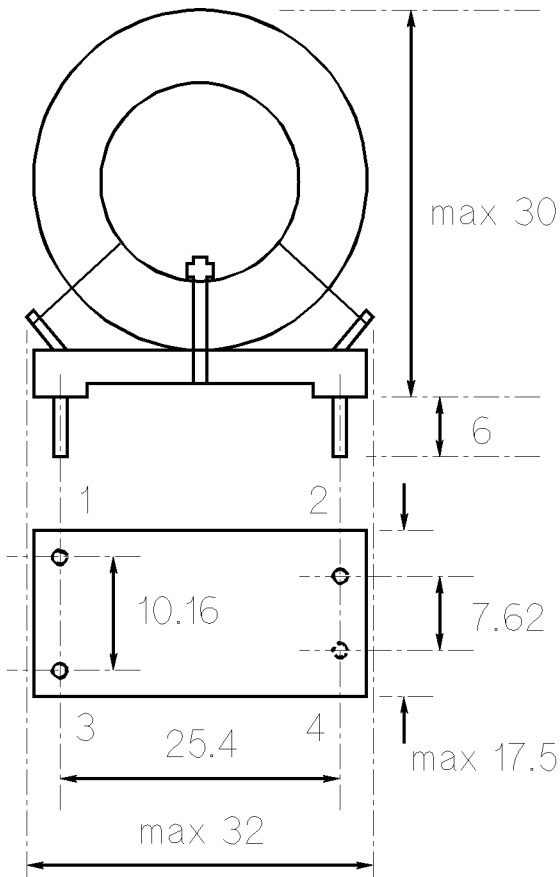

Typical Insertion loss v. Frequency (50 ohm system)

Type Number	(min.) mH	I max * A	Rdc Typ. mOhms
15 SC 137	10	2	150
15 SC 177	2.2	4	44
15 SC 178	1.1	6	21
15 SC 179	0.6	8	11

Insertion Loss up to 50 MHz > 20 dB typical
 Insertion Loss up to 1 GHz > 10 dB typical
 Insulation Test 3kV dc.
 Core Toroidal Ferrite
 Working Temperature -55°C to +85°C

**Double Insulated
common mode
choke for
interference
suppression of
incoming mains
supplies.**

**These chokes are
sometimes called
current compen-
sated chokes.**

To order these chokes please specify the type number.

* For other temperatures use the "Load Ratings" curve 2 on page 17.

FERROPERM

Types 15SC 216, 217, 218, 219, 63, 108

SINGLE LINE SUPPRESSION CHOKES

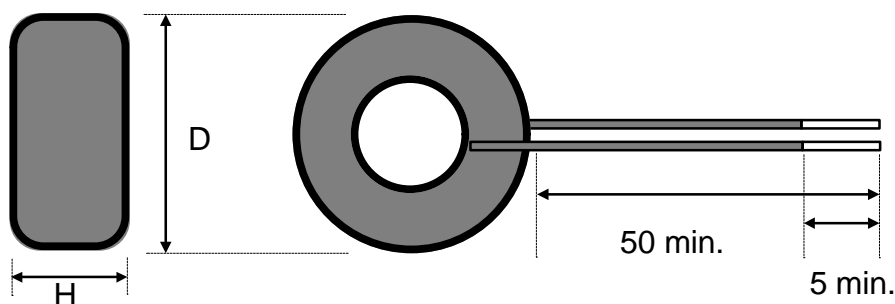

Single line chokes for suppression in mains supply lines in equipment utilising SCRs or Triacs phase angle control applications. e.g. Light dimmers or motor speed controllers.

Core Iron Dust.
 Terminations Wire ended.
 Working Temperature -55 to +85 °C ambient.
 Marking None.

Type number	Inductance mH-20+80%	* I max. A	Rdc Typ. Ohms	Dimensions D x H
15 SC 216	4	0.4	1.8	20 x 8
15 SC 217	4	1	0.9	25 x 10
15 SC 218	2.9	1.6	0.5	30 x 15
15 SC 219	2.4	2	0.4	32 x 16
15 SC 63	0.8	5	0.15	45 x 17
15 SC 108	0.8	10	0.06	54 x 23

All chokes are supplied with 50mm minimum lead length of which at least 5mm is solder-dipped.

Note that type 15 SC 108 is bifilar wound with two wires. These must be connected in parallel for correct operation.

* I_{max} = Maximum current at 40 °C ambient. For other temperatures use the "Load Ratings" curve 2 on page 17

To order these chokes please specify the type number.

Dimension are in mm and are nominal values.

FERROPERM

CUSTOM INDUCTORS

from FERROPERM UK Ltd.

If you already have inductor designs, we will be pleased to quote for their manufacture. Just send us your drawings!

If you would like us to design inductors to meet your requirements, please send us the following information. If you do not have all the information available, please just give what you can.

1. Specify the application. (For example, Energy Storage Choke for a Switched Mode Power Supply). Please give as much information as you can.
2. Specify the maximum dimensions of the space you have available for the inductor.
3. Specify if you require surface mounting or through-hole mounting.
4. If you have a preference for a particular hardware design (for example rod or toroidal), please state it.
5. Specify your estimated requirements of quantities and delivery dates both for short term and long term. This is important because it may influence what hardware is specified for the design.
6. If you have a target or maximum price level, please state it.
7. Specify maximum average direct current flow.
8. Specify maximum peak current flow.
9. Sketch or describe any alternating current waveform (other than interference current). If the waveform is variable, please specify the extremes.

FOR ENERGY STORAGE CHOKES (INDUCTORS):

10. Specify inductance and widest acceptable tolerance at near zero current, at maximum average current and at maximum peak current.

FOR ALL OTHER INDUCTORS:

10. EITHER specify inductance and widest acceptable tolerance
OR specify minimum required impedance at particular frequencies or sketch
a graph of minimum required impedance
versus frequency.
11. Specify if common mode (current compensated) design is required.
(Examples of common mode chokes are shown on page 13.)
12. Specify maximum working voltage between windings if common mode.
13. If this working voltage is a.c., please specify the frequency.

FERROPERM

CUSTOM TRANSFORMERS

from FERROPERM UK Ltd.

If you already have transformer designs, we will be pleased to quote for their manufacture. Just send us your drawings!

If you would like us to design transformers to meet your requirements, please send us the following information. If you do not have all the information available, please just give what you can.

1. Specify the application. (For example, Switched Mode Power Supply (SMPS) in an instrument). Please give as much information as you can.
2. Indicate by a schematic or describe how the transformer is driven and used. (For example, push-pull FET drive in a SMPS). Please give as much information as you can.
3. Draw a schematic of all windings with turns ratios and widest acceptable tolerance of turns ratios. Indicate polarity of windings where it is important. For windings with one or more taps between the ends, please make clear what turns ratios are required for each section of the winding!
4. Specify what voltage isolation requirements there are between all windings.
5. Draw or describe the voltage waveform which will be applied to the primary winding. If the waveform is variable, please specify the extremes.
6. Specify maximum working currents to be drawn from all secondary windings.
7. If occasional overload conditions have to be met, please specify these separately.
8. Specify the maximum dimensions of the space you have available for the transformer.
9. Specify if you require surface mounting or through-hole mounting.
10. If you have a preference for a particular hardware design (for example ETD, RM or toroidal), please state it.
11. Specify your estimated requirements of quantities and delivery dates both for short term and long term. This is important because it may influence what hardware is specified for the design.
12. If you have a target or maximum price level, please state it.

FERROPERM

INDUCTORS AND TRANSFORMERS

from FERROPERM UK Ltd.

LOAD RATINGS for CHOKES

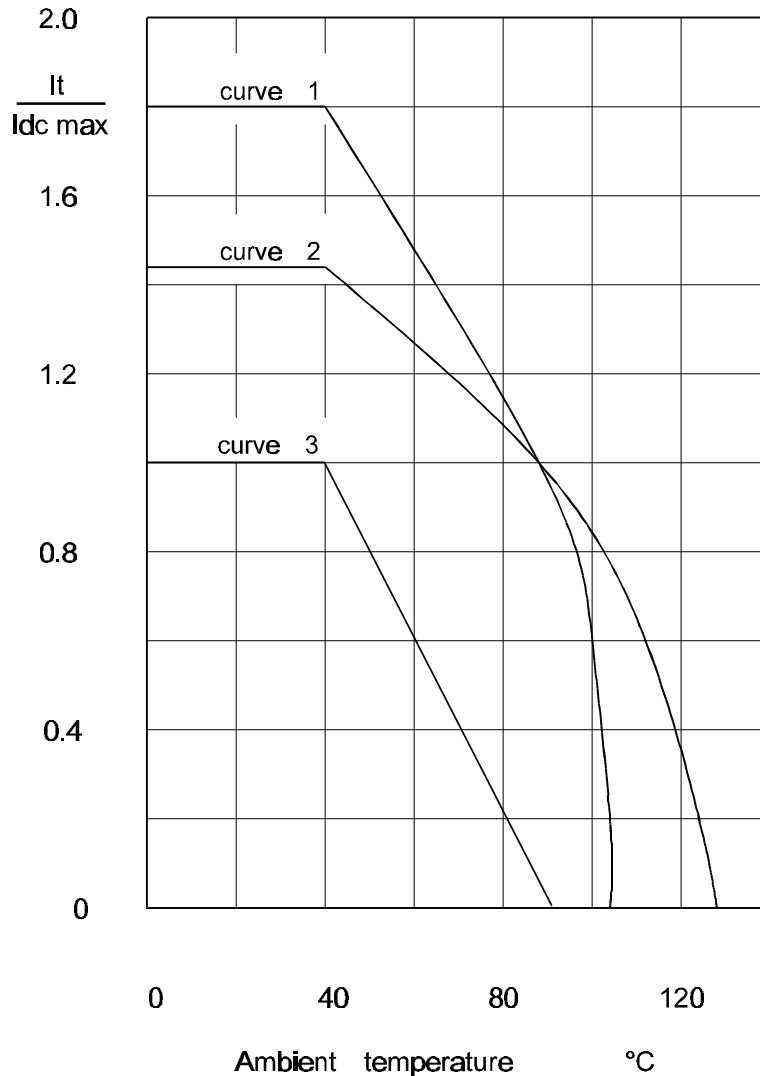

I_t = Maximum current at ambient temperature

$I_{dc\ max}$ = Maximum current shown on data sheet.

Whilst every care was taken to avoid any mistakes in the compilation of this catalogue, no responsibility can be assumed for any errors which may have occurred in it.

In line with Ferroperm's policy of continual development, Ferroperm reserves the right to alter specifications of any products without notice.

FERROPERM

The Reliable Source ..

FERROPERM

... serving the

electronics industry

Other products from Ferroperm include ...

- Filtered Sub-D Connectors
- Soft magnetic Ferrites & Iron Dust Cores
- Hard magnetic Ferrites
- Piezo Electric Ceramics
- Thin Film Optical Interference Filters

FERROPERM UK LTD.
Vauxhall Industrial Estate,
Ruabon, Wrexham,
Clwyd LL14 6HA.
United Kingdom.
Phone +44 1978 823 990
Fax +44 1978 810 128



Catch us on the web at
<http://www.ferroperm.co.uk>

Email us on
mail@ferroperm.co.uk