

1A, 20V - 150V Schottky Barrier Surface Mount Rectifier

FEATURES

- Low power loss, high efficiency
- Ideal for automated placement
- Guard ring for overvoltage protection
- High surge current capability
- Moisture sensitivity level: level 1, per J-STD-020
- RoHS Compliant
- Halogen-free

APPLICATIONS

- Switching mode power supply (SMPS)
- Adapters
- Monitor
- DC/DC converters
- TV

MECHANICAL DATA

- Case: DO-214AC (SMA)
- Molding compound meets UL 94V-0 flammability rating
- Terminal: Matte tin plated leads, solderable per J-STD-002
- Meet JESD 201 class 2 whisker test
- Polarity: Indicated by cathode band
- Weight: 0.060g (approximately)

KEY PARAMETERS		
PARAMETER	VALUE	UNIT
I_F	1	A
V_{RRM}	20 - 150	V
I_{FSM}	40	A
$T_{J\ MAX}$	125, 150	°C
Package	DO-214AC (SMA)	
Configuration	Single die	



DO-214AC (SMA)



ABSOLUTE MAXIMUM RATINGS ($T_A = 25^\circ\text{C}$ unless otherwise noted)										
PARAMETER	SYMBOL	SS12	SS13	SS14	SS15	SS16	SS19	SS110	SS115	UNIT
Marking code on the device		SS12	SS13	SS14	SS15	SS16	SS19	SS110	SS115	
Repetitive peak reverse voltage	V_{RRM}	20	30	40	50	60	90	100	150	V
Reverse voltage, total rms value	$V_{R(RMS)}$	14	21	28	35	42	63	70	105	V
Forward current	I_F	1								A
Peak forward surge current, 8.3ms single half sine-wave superimposed on rated load	I_{FSM}	40								A
Critical rate of rise of off-state voltage	dV/dt	10,000								V/ μs
Junction temperature	T_J	- 55 to +125				- 55 to +150				°C
Storage temperature	T_{STG}	- 55 to +150								°C

THERMAL PERFORMANCE

PARAMETER	SYMBOL	TYP	UNIT
Junction-to-lead thermal resistance	$R_{\theta JL}$	28	°C/W
Junction-to-ambient thermal resistance	$R_{\theta JA}$	88	°C/W

ELECTRICAL SPECIFICATIONS ($T_A = 25^\circ\text{C}$ unless otherwise noted)

PARAMETER	CONDITIONS	SYMBOL	TYP	MAX	UNIT			
Forward voltage ⁽¹⁾	SS12 SS13 SS14	$I_F = 1\text{A}, T_J = 25^\circ\text{C}$	V_F	-	0.50	V		
	SS15 SS16			-	0.75	V		
	SS19 SS110			-	0.80	V		
	SS115			-	0.95	V		
	SS12 SS13 SS14			$I_F = 1\text{A}, T_J = 100^\circ\text{C}$	-	0.40	V	
	SS15 SS16				-	0.65	V	
	SS19 SS110				-	0.70	V	
	SS115				-	0.85	V	
	SS12 SS13 SS14				$T_J = 25^\circ\text{C}$	I_R	-	200
	SS15 SS16			-			100	μA
SS19 SS110 SS115	-	6	mA					
SS12 SS13 SS14	$T_J = 100^\circ\text{C}$	-	5	mA				
SS15 SS16		-	-	mA				
SS19 SS110 SS115		-	-	mA				
SS12 SS13 SS14	$T_J = 125^\circ\text{C}$	-	-	mA				
SS15 SS16		-	-	mA				
SS19 SS110 SS115		-	2	mA				

Notes:

1. Pulse test with $PW = 0.3\text{ms}$
2. Pulse test with $PW = 30\text{ms}$

ORDERING INFORMATION

ORDERING CODE⁽¹⁾	PACKAGE	PACKING
SS1x	DO-214AC (SMA)	7,500 / Tape & Reel

Notes:

1. “x” defines voltage from 20V(SS12) to 150V(SS115)

CHARACTERISTICS CURVES

($T_A = 25^\circ\text{C}$ unless otherwise noted)

Fig.1 Forward Current Derating Curve

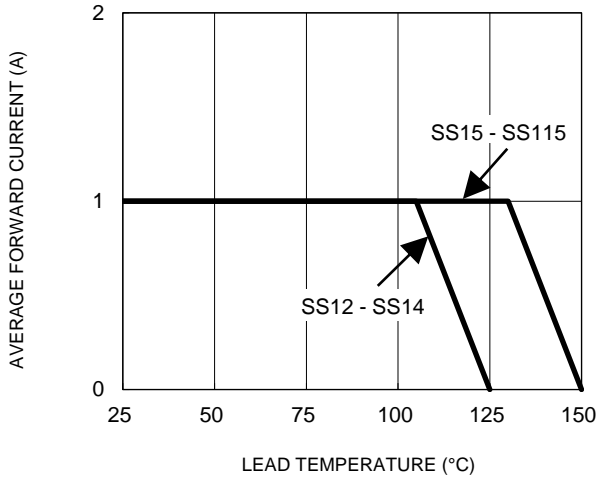

Fig.2 Typical Junction Capacitance

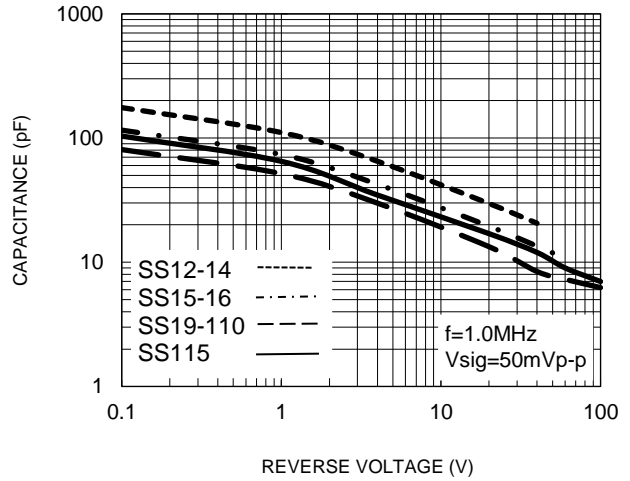

Fig.3 Typical Reverse Characteristics

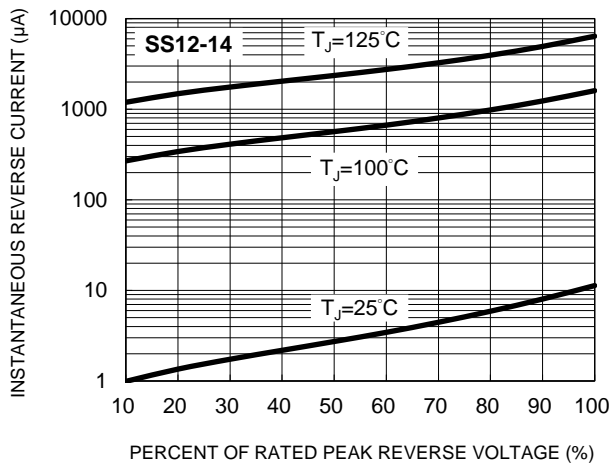

Fig.4 Typical Forward Characteristics

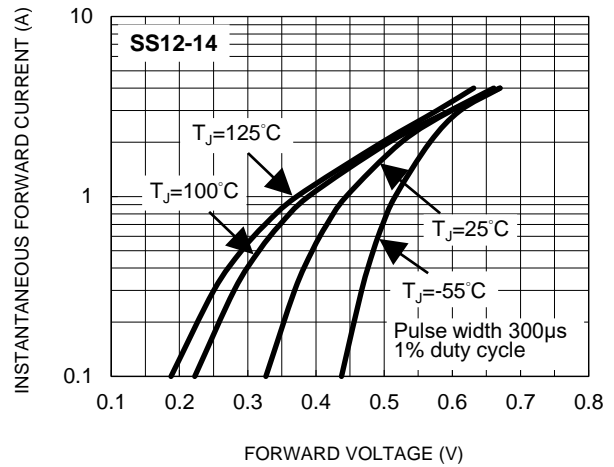

Fig.5 Typical Reverse Characteristics

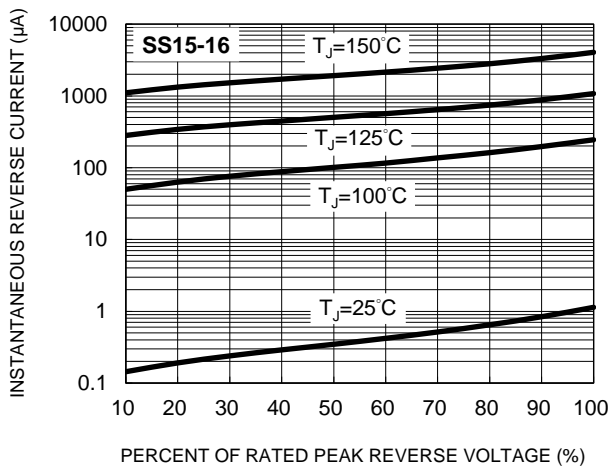
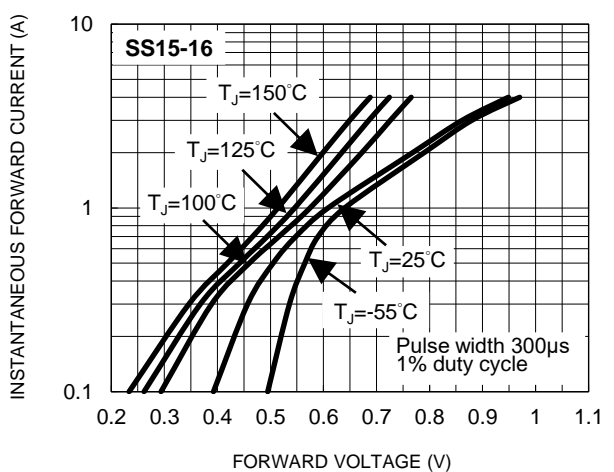

Fig.6 Typical Forward Characteristics



CHARACTERISTICS CURVES

($T_A = 25^\circ\text{C}$ unless otherwise noted)

Fig.7 Typical Reverse Characteristics

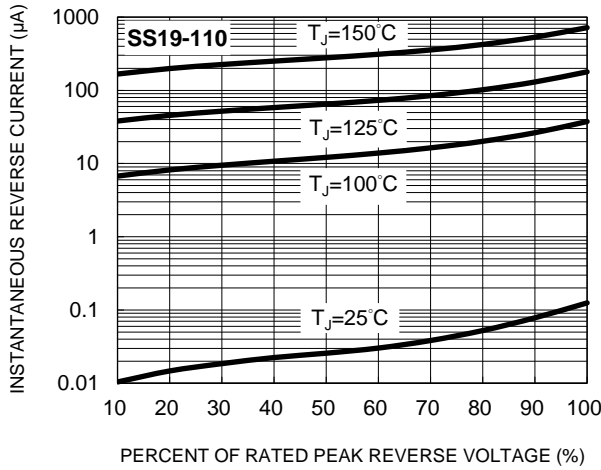

Fig.8 Typical Forward Characteristics

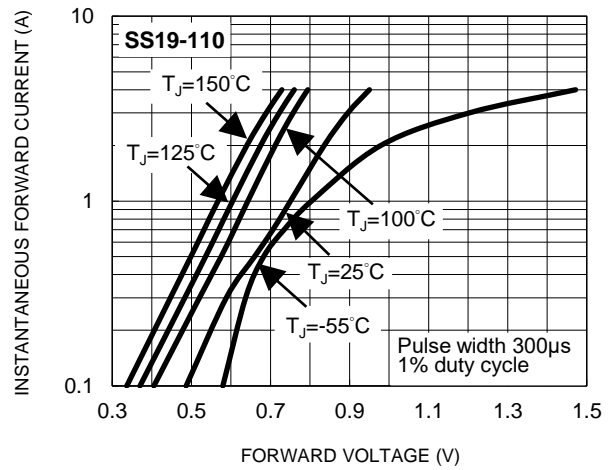

Fig.9 Typical Reverse Characteristics

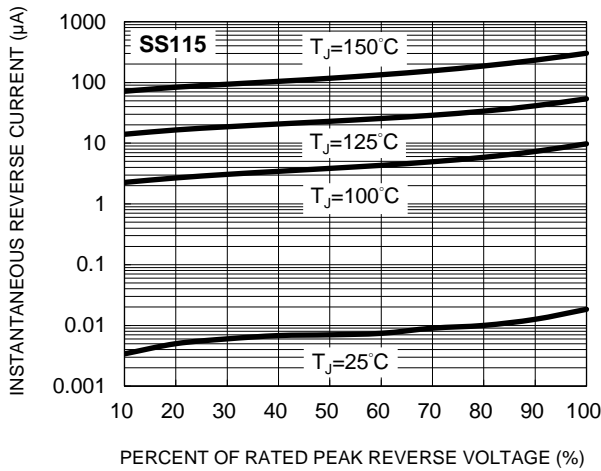

Fig.10 Typical Forward Characteristics

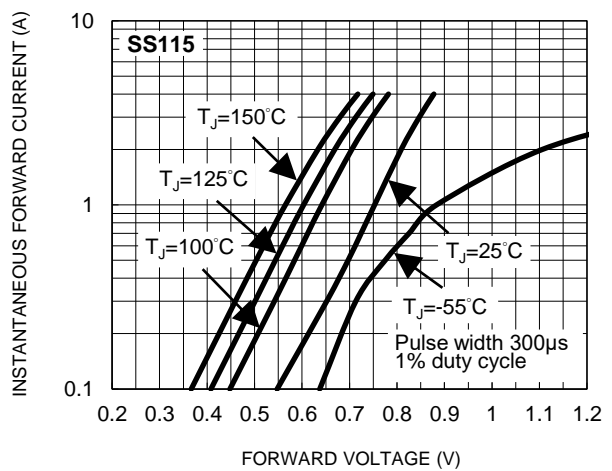
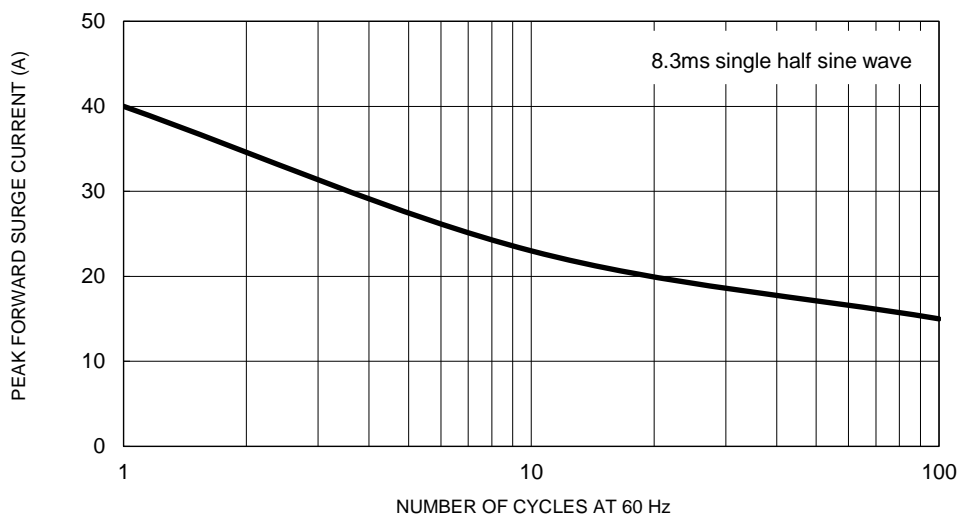

Fig.11 Maximum Non-Repetitive Forward Surge Current



CHARACTERISTICS CURVES

($T_A = 25^\circ\text{C}$ unless otherwise noted)

Fig.12 Typical Transient Thermal Characteristics

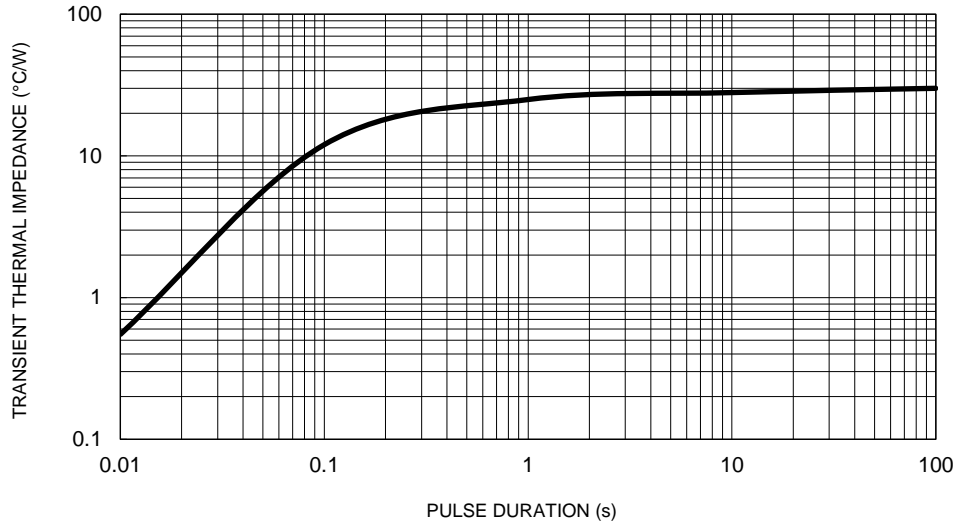

PACKAGE OUTLINE DIMENSIONS

DO-214AC (SMA)

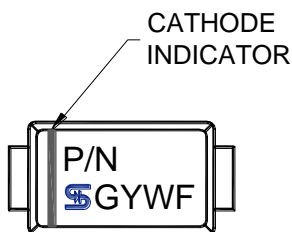
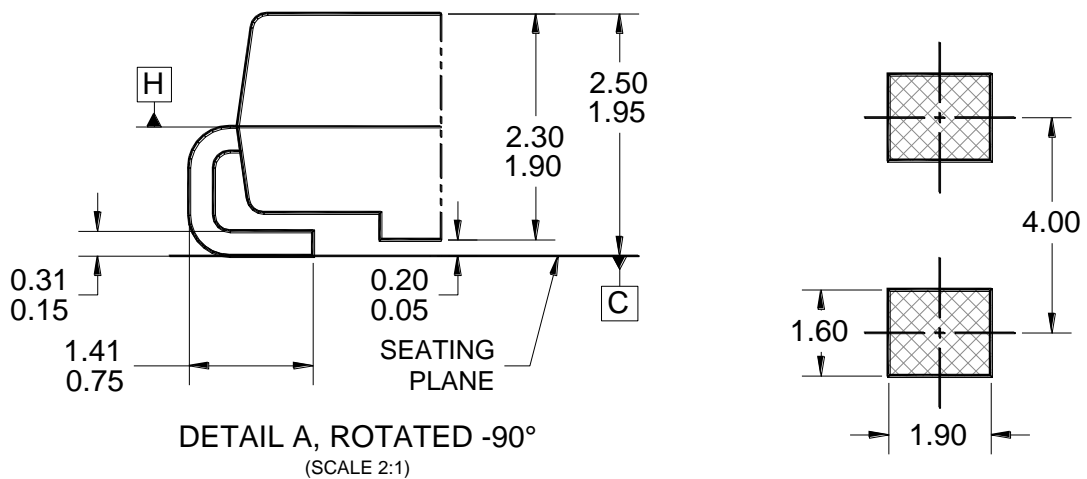
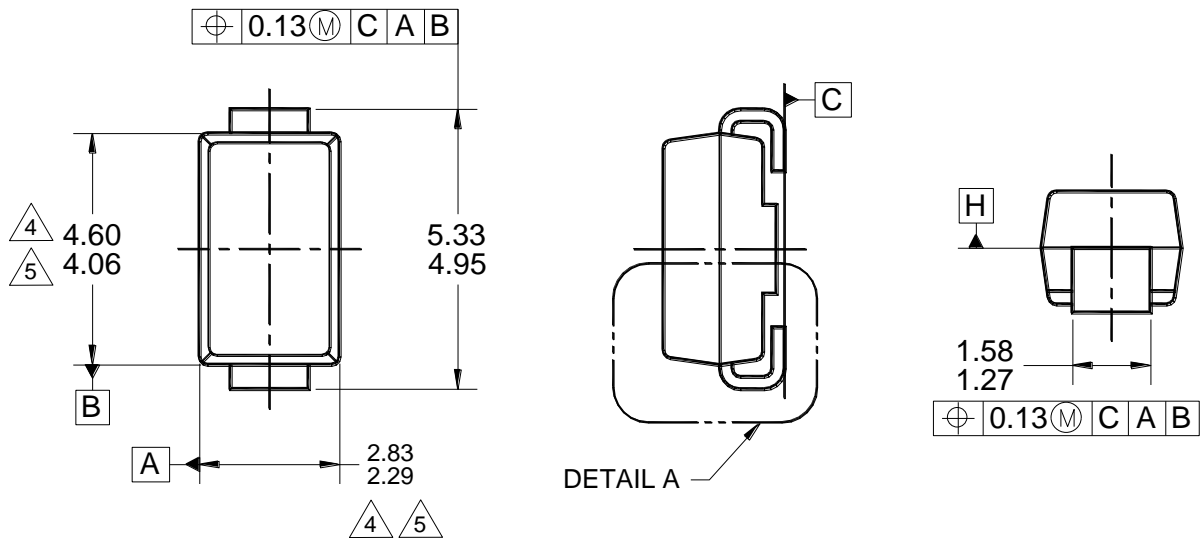

MARKING DIAGRAM

P/N = MARKING CODE
G = GREEN COMPOUND
YW = DATE CODE
F = FACTORY CODE

NOTES: UNLESS OTHERWISE SPECIFIED

1. ALL DIMENSIONS ARE IN MILLIMETERS.
2. DIMENSIONING AND TOLERANCING PER ASME Y14.5M-1994.
3. PACKAGE OUTLINE REFERENCE: JEDEC DO-214, VARIATION AC, ISSUE D.
4. MOLDED PLASTIC BODY DIMENSIONS DO NOT INCLUDE MOLD FLASH.
5. MOLDED PLASTIC BODY LATERAL DIMENSIONS TO BE DETERMINED AT DATUM PLANE H.
6. DWG NO. REF: HQ2SD07-DO214SMC-034 REV A.

Notice

Specifications of the products displayed herein are subject to change without notice. TSC or anyone on its behalf assumes no responsibility or liability for any errors or inaccuracies.

Purchasers are solely responsible for the choice, selection, and use of TSC products and TSC assumes no liability for application assistance or the design of Purchasers' products.

Information contained herein is intended to provide a product description only. No license, express or implied, to any intellectual property rights is granted by this document. Except as provided in TSC's terms and conditions of sale for such products, TSC assumes no liability whatsoever, and disclaims any express or implied warranty, relating to sale and/or use of TSC products including liability or warranties relating to fitness for a particular purpose, merchantability, or infringement of any patent, copyright, or other intellectual property right.

The products shown herein are not designed for use in medical, life-saving, or life-sustaining applications. Customers using or selling these products for use in such applications do so at their own risk and agree to fully indemnify TSC for any damages resulting from such improper use or sale.