

SPECIFICATION

PATENT GRANTED

Part No : **FXUB66.01.0150C**

Product Name : Maximus Flexible Ultra Wide Band Antenna 700-6000MHz

Features : Ground Plane Independent
700-6000MHz
5 dBi Peak Gain
Efficiencies above 60% on all cellular 2G/3G/4G bands
120.4x50.4x0.2 mm size
SMA(M) Connector
RoHS Compliant



1. Introduction

The patent granted Maximus FXUB66 flexible ultra wideband antenna has been designed to cover all working frequencies in the 700-6000 MHz spectrum, including all Cellular, Wi-Fi, ISM and GNSS bands. Its use in a device improves substantially the radiated power and sensitivity, and enables the highest throughput rates of today's broadband devices.

The antenna is delivered with a flexible body with ground breaking high efficiencies on all bands, ground-plane independent, with a cable and connector for easy installation. It is made of durable flexible polymer, with a peak gain of 5dBi, an efficiency of more than 60% across all cellular bands and is designed to be mounted directly onto a plastic or glass enclosure / cover.

At 120.4x50.4x.2mm, the antenna is ultra thin. It is assembled by a simple “peel and stick” process, attaching securely to non-metal surfaces via 3M adhesive. It enables designers to use only one antenna that covers all frequencies and future proofs device design for LTE and 4G globally. It is also the ideal antenna to fit in devices that are being retrofitted with wireless functionality, as it will cover non-cellular applications such as 868, 915MHz or Zigbee applications. It's inherently wide bandwidth is more resistant to detuning than traditional small but narrow-band legacy antennas.

The Maximus antenna has a unique hybrid design. Within one antenna structure the electromagnetic waves travel in two predominant propagation modes - one for lower frequencies, (e.g. LTE at 700 MHz) and the other for higher 4G and Wi-Fi frequencies up to 6GHz.

It is an ideal choice for any device maker that needs to keep manufacturing costs down over the lifetime of a product, as the same antenna can be used if the radio module is upgraded to work on a different frequency band.

Cables and Connectors are customizable.

2. Specification

ELECTRICAL										
Band	700/800/ 850/900	1400	1575	1700 /1800 /1900	2100	2300	2400	2600	3500	5000
Standard	LTE/GSM/ CDMA	MIL	GPS	LTE/GSM /CDMA	UMTS/ HSPA	LTE	ISM/ WIFI	LTE	LTE	ISM/ WIFI
Frequency (MHz)	698-960	1390 -1435	1575.42	1710 -1990	1755 -2170		2400 -2500	2500 -2700	3400 -3600	4800 -6000
Polarization	Linear									
Impedance (Ohms)	50 Ohms									
Max VSWR	3.5:1	3.5:1	1.1:1	3.0:1	3.3:1		2.2:1	2.0:1	2.2:1	3.0:1
Max Return Loss (dB)	-5	-5	-20	-6	-5.5		-7	-10	-7	-6
Peak Gain (dBi)	2.7	3.8	5	5	5		3.5	3.8	6.4	5.5
Efficiency (%)	80	55	75	78	65		75	75	85	60
Average Gain (dB)	-0.97	-2.6	-1.1	-1	-1.8		-1.1	-1.1	-0.7	-2
Radiation Properties	Omni-directional									
Max Input Power (Watts)	5									

*Antenna measured on 2mm ABS plastic plate.

MECHANICAL	
Dimensions (mm)	120.4x50.4x0.2 mm
Material	Flexible Polymer
Connector and Cable	SMA(M) and 1.37 mm mini coax

ENVIRONMENTAL	
Operation Temperature	-40°C to 85°C
Storage Temperature	-40°C to 85°C
Relative Humidity	40% to 95%
RoHs Compliant	Yes

3. Test Setup



Figure 1. Impedance measurements (left hand) and peak gain, average gain, efficiency and radiation pattern measurements (right hand).

4. Antenna Parameters

4.1. Return Loss

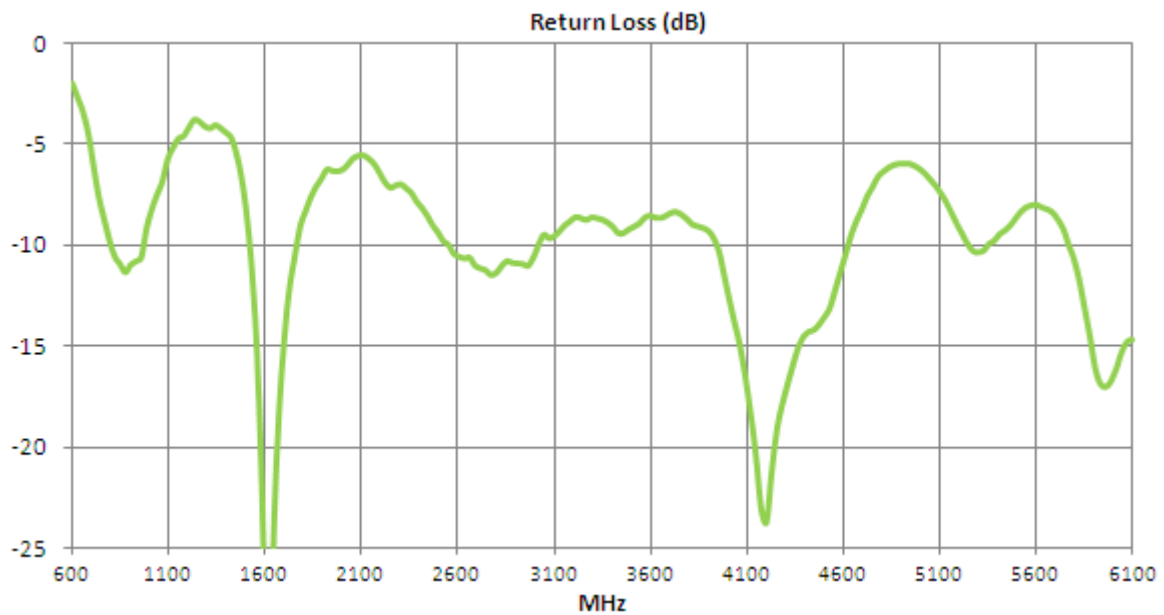

Figure 2. Return loss of FXUB66 UWB Antenna.

4.2. VSWR

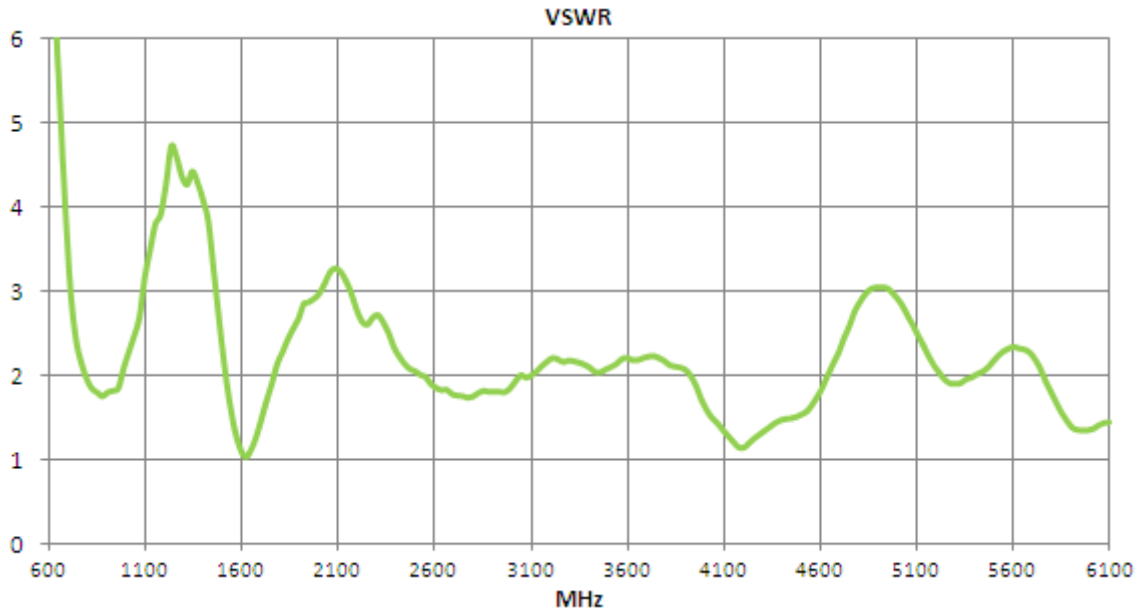

Figure 3. VSWR of FXUB66 UWB Antenna.

4.3. Efficiency



Figure 4. Efficiency of FXUB66 UWB Antenna.

4.4. Peak Gain

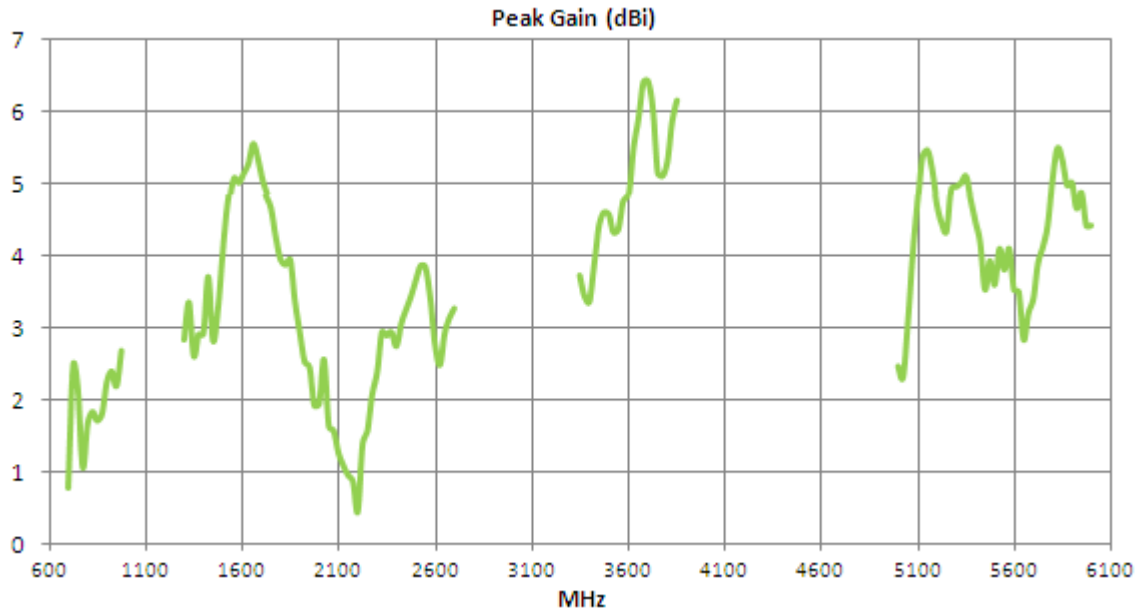

Figure 5. Peak Gain of FXUB66 UWB Antenna.

4.5. Average Gain

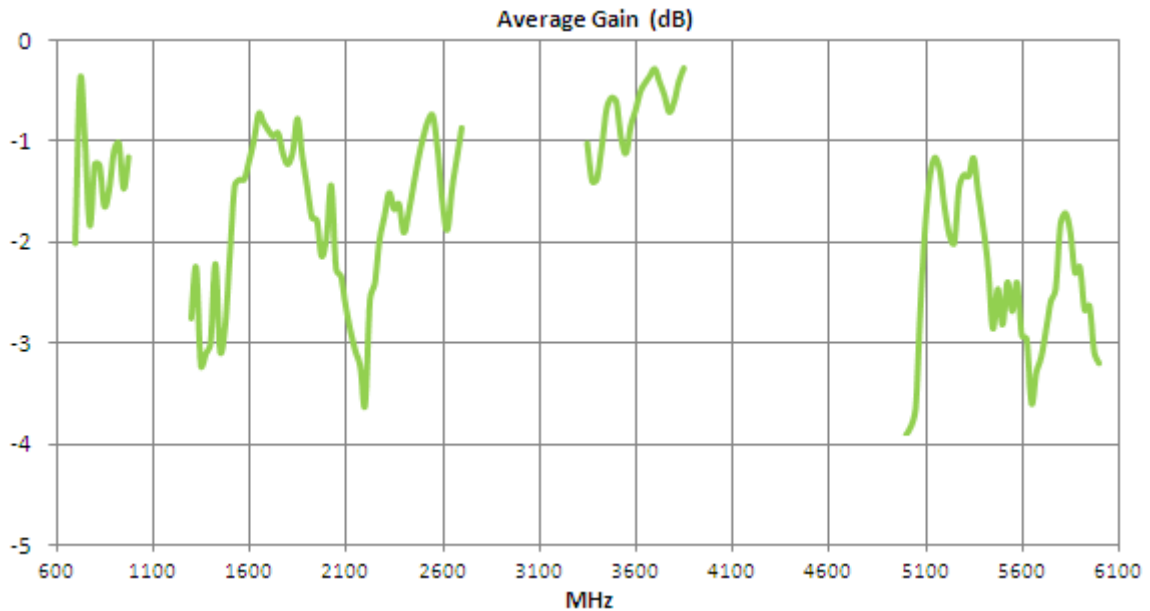

Figure 6. Average Gain of FXUB66 UWB Antenna.

4.6. Radiation Pattern

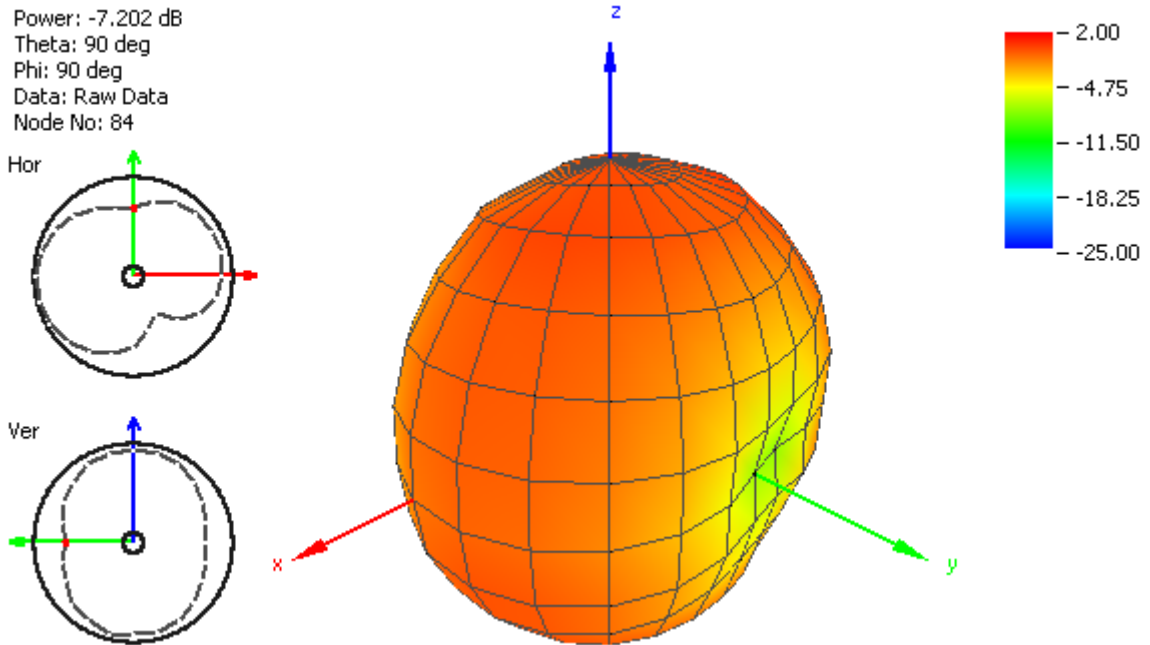

Figure 7. Radiation Pattern at 750 MHz of FXUB66 UWB Antenna.

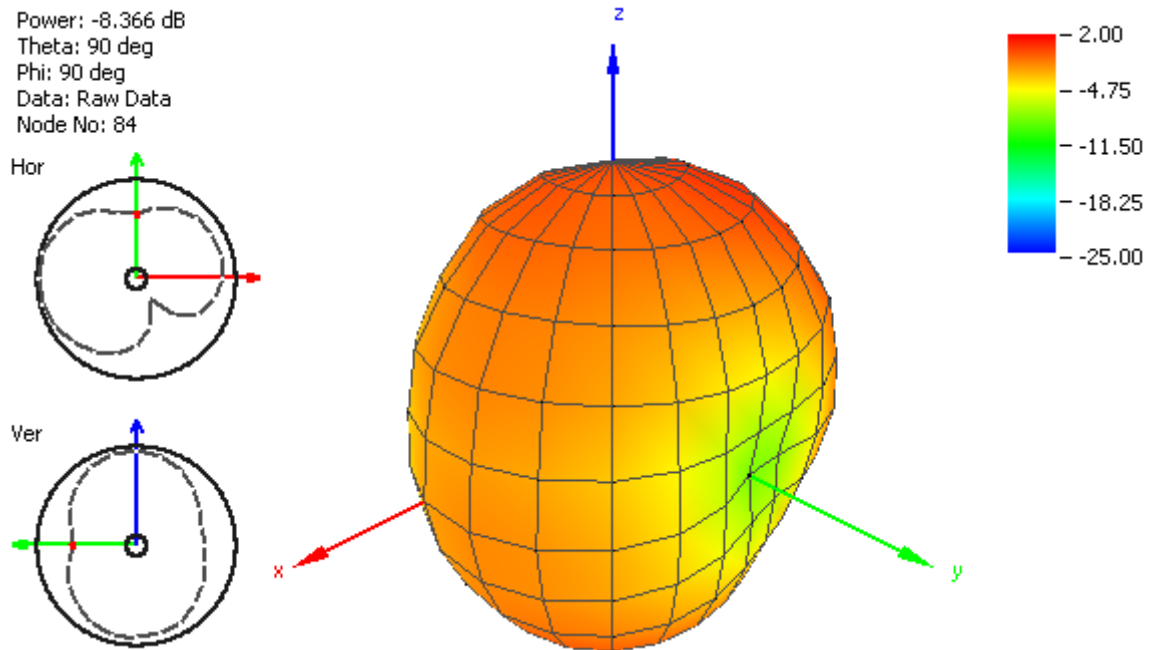

Figure 8. Radiation Pattern at 850 MHz of FXUB66 UWB Antenna.

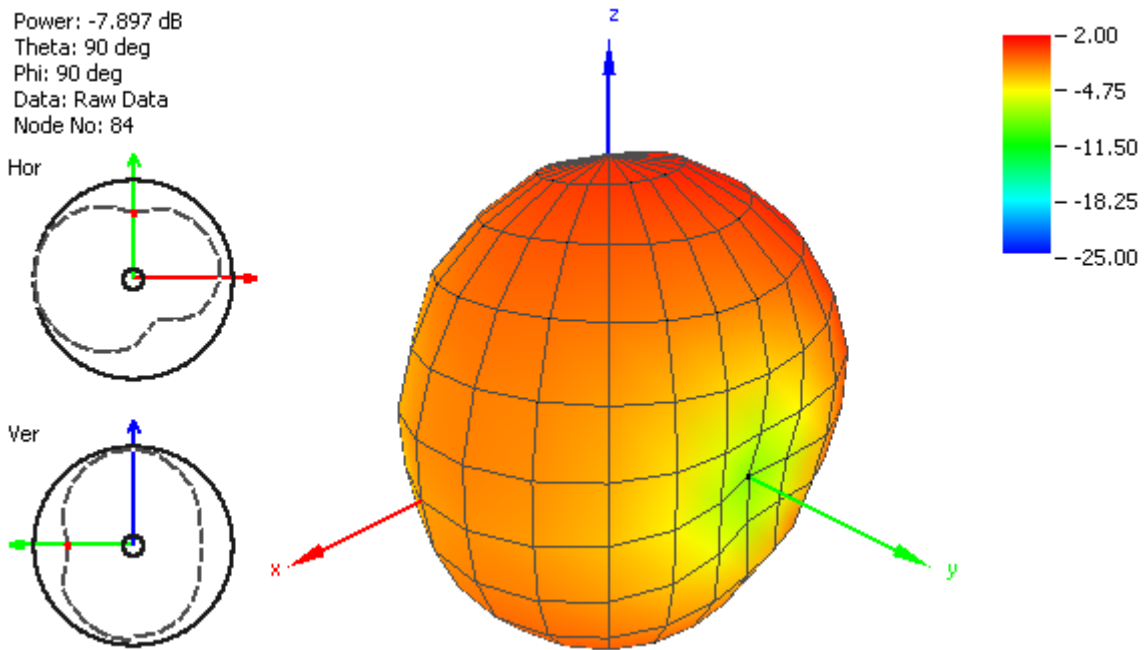

Figure 9. Radiation Pattern at 925 MHz of FXUB66 UWB Antenna.

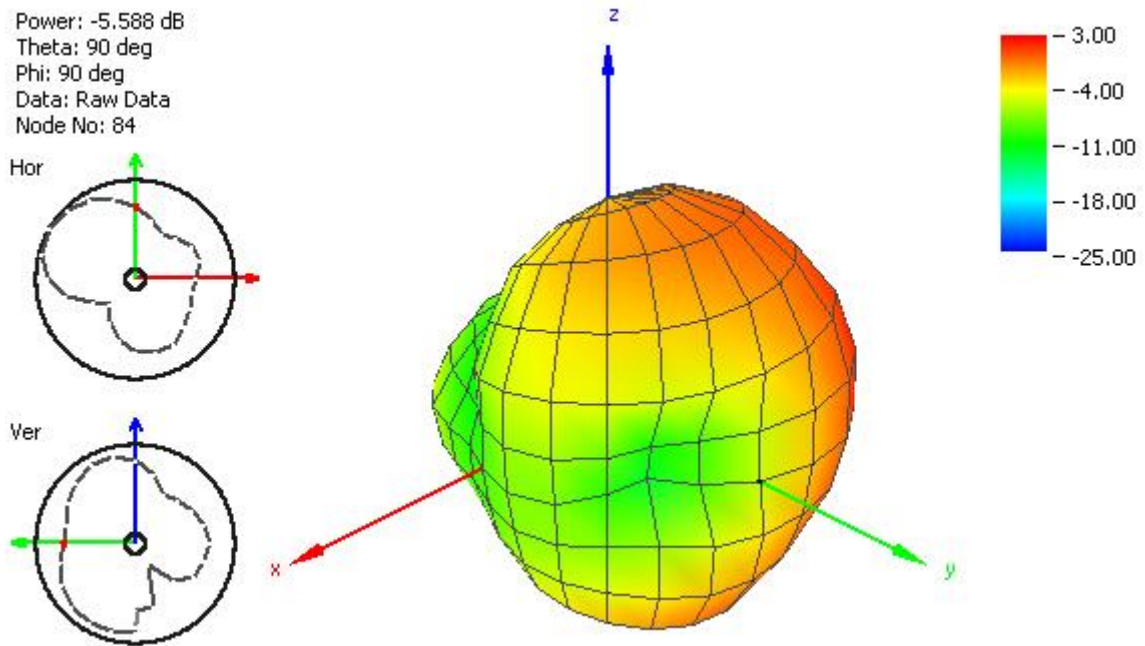

Figure 10. Radiation Pattern at 1400 MHz of FXUB66 UWB Antenna.

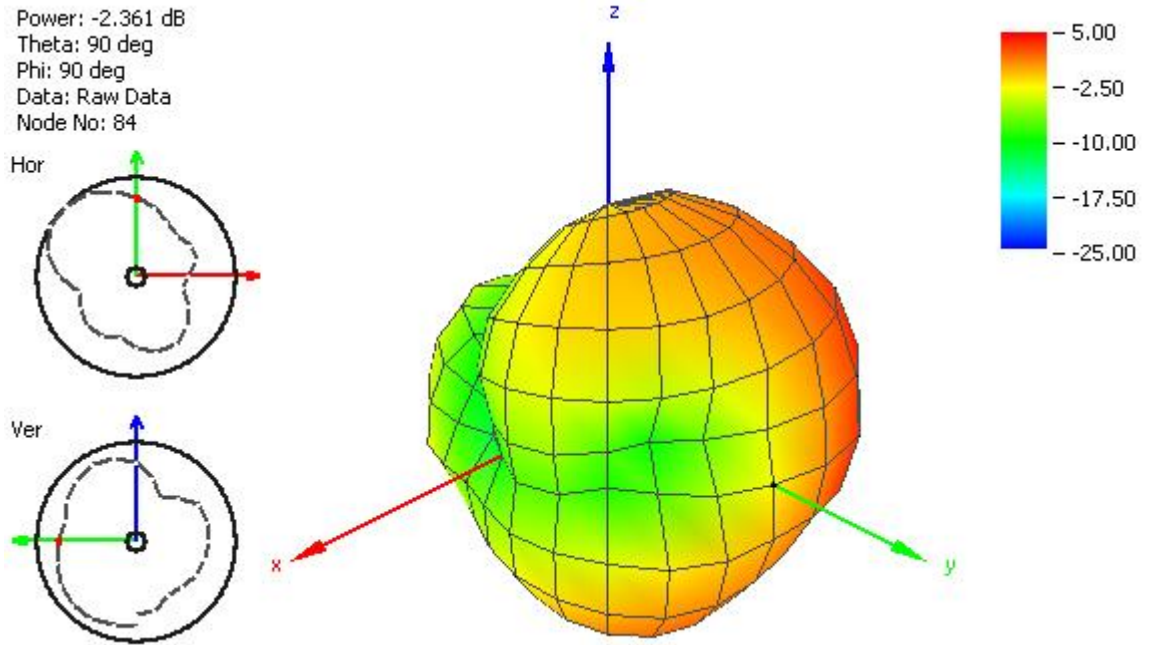

Figure 11. Radiation Pattern at 1575 MHz of FXUB66 UWB Antenna.

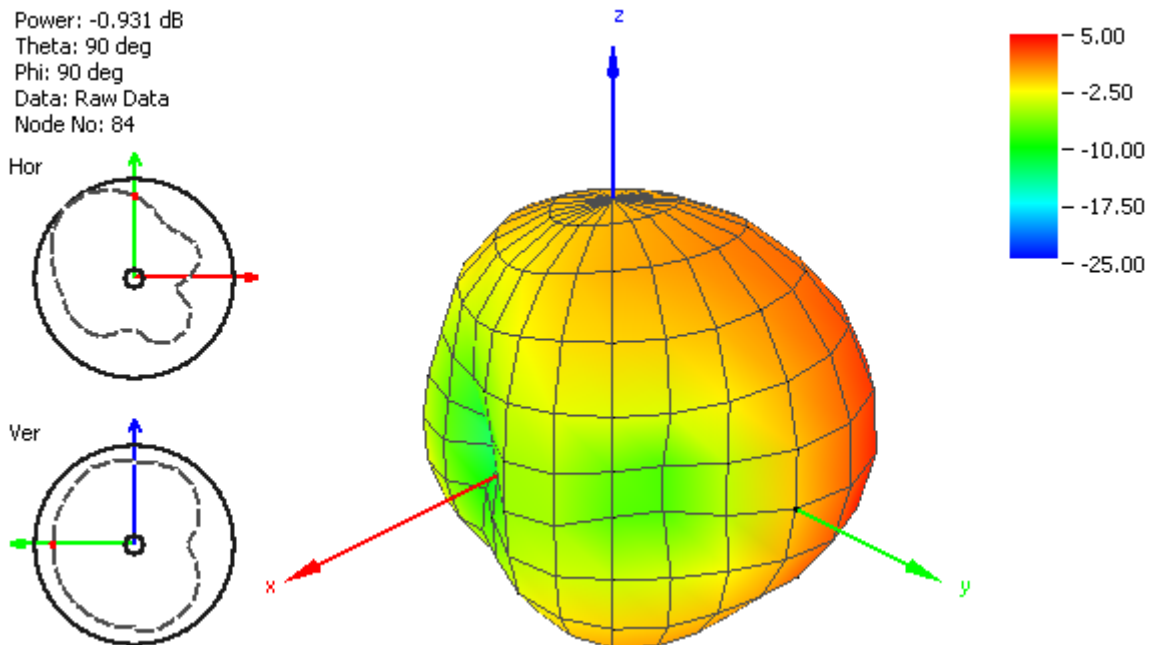

Figure 12. Radiation Pattern at 1750 MHz of FXUB66 UWB Antenna.

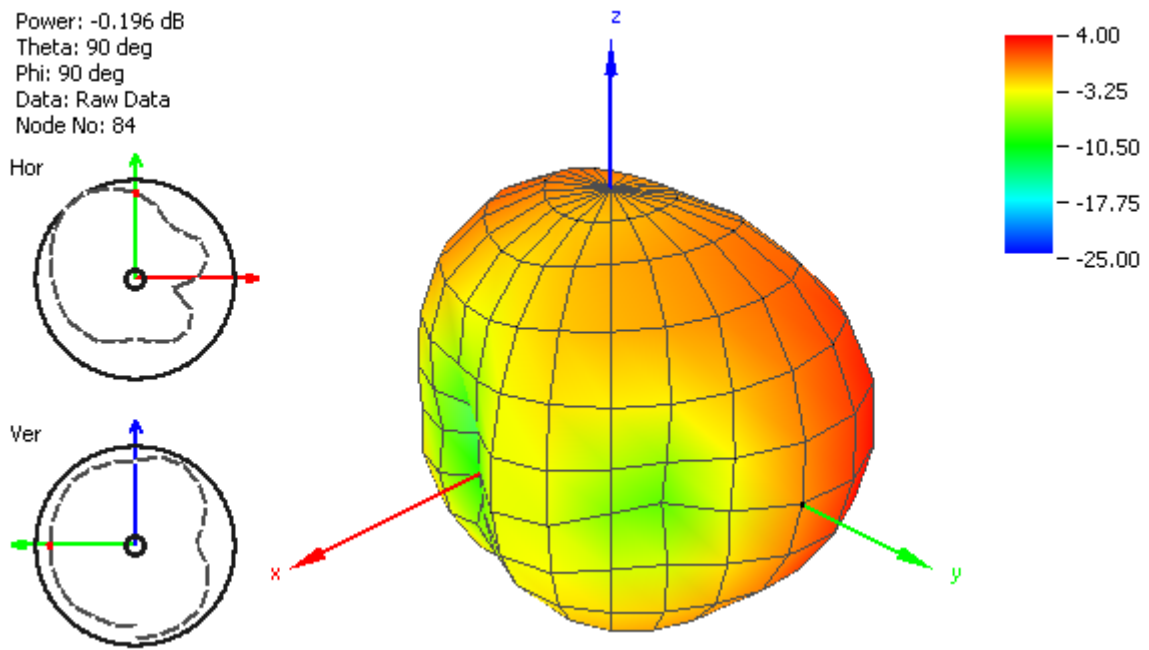

Figure 13. Radiation Pattern at 1850 MHz of FXUB66 UWB Antenna.

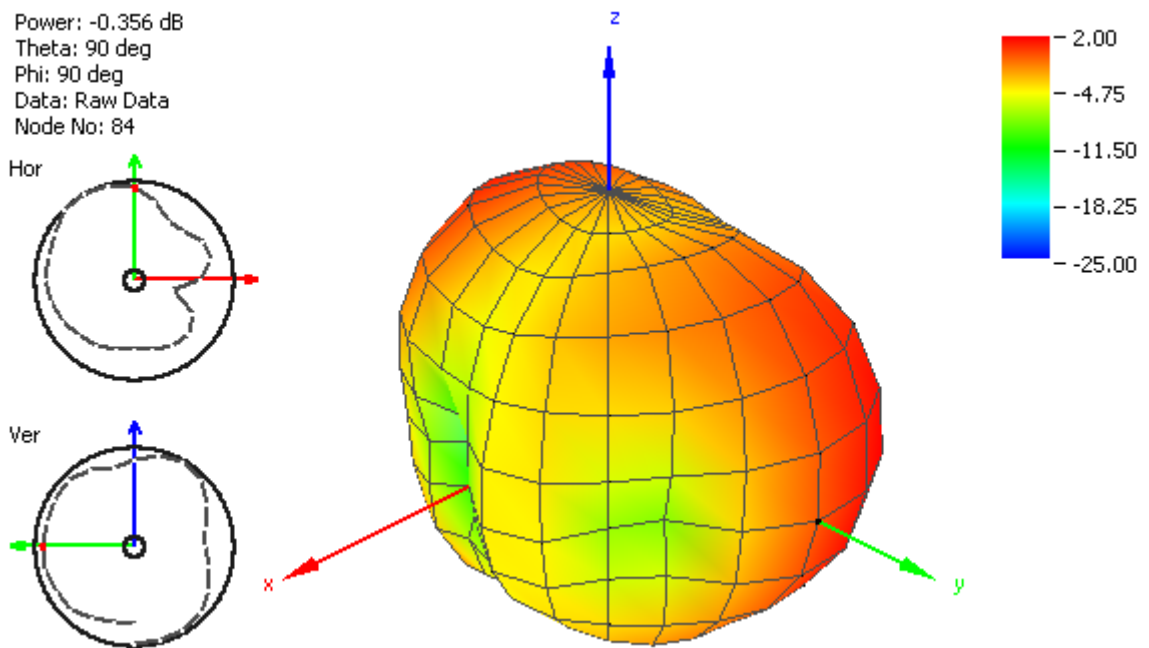

Figure 14. Radiation Pattern at 1950 MHz of FXUB66 UWB Antenna.

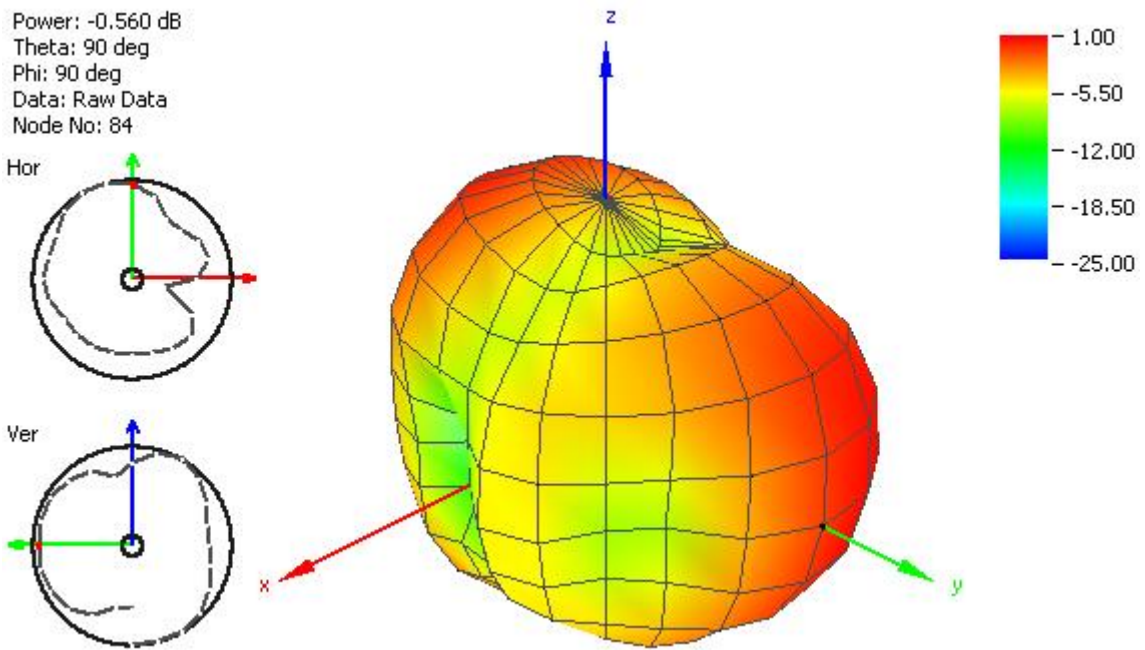

Figure 15. Radiation Pattern at 2100 MHz of FXUB66 UWB Antenna.

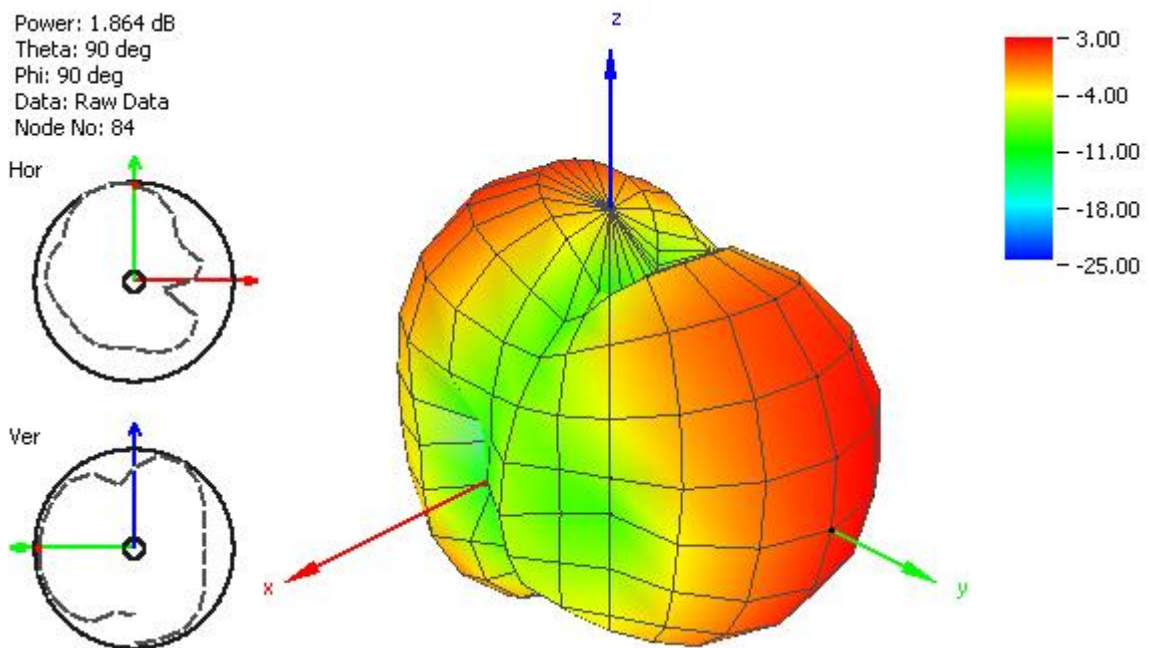

Figure 16. Radiation Pattern at 2450 MHz of FXUB66 UWB Antenna.

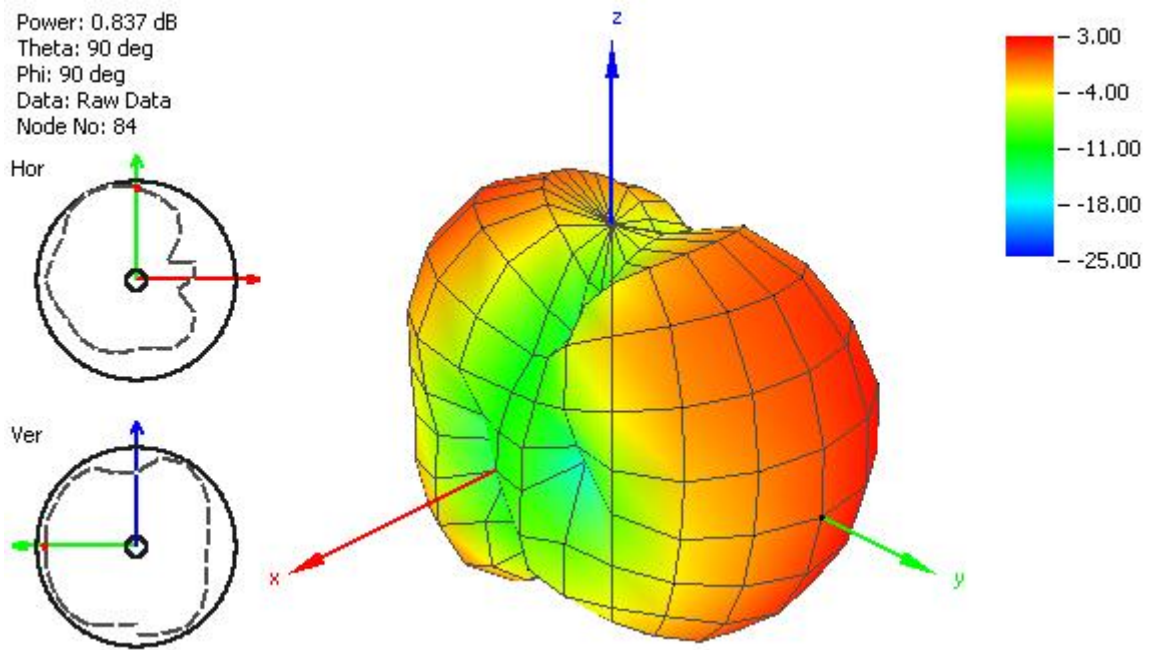

Figure 17. Radiation Pattern at 2600 MHz of FXUB66 UWB Antenna.

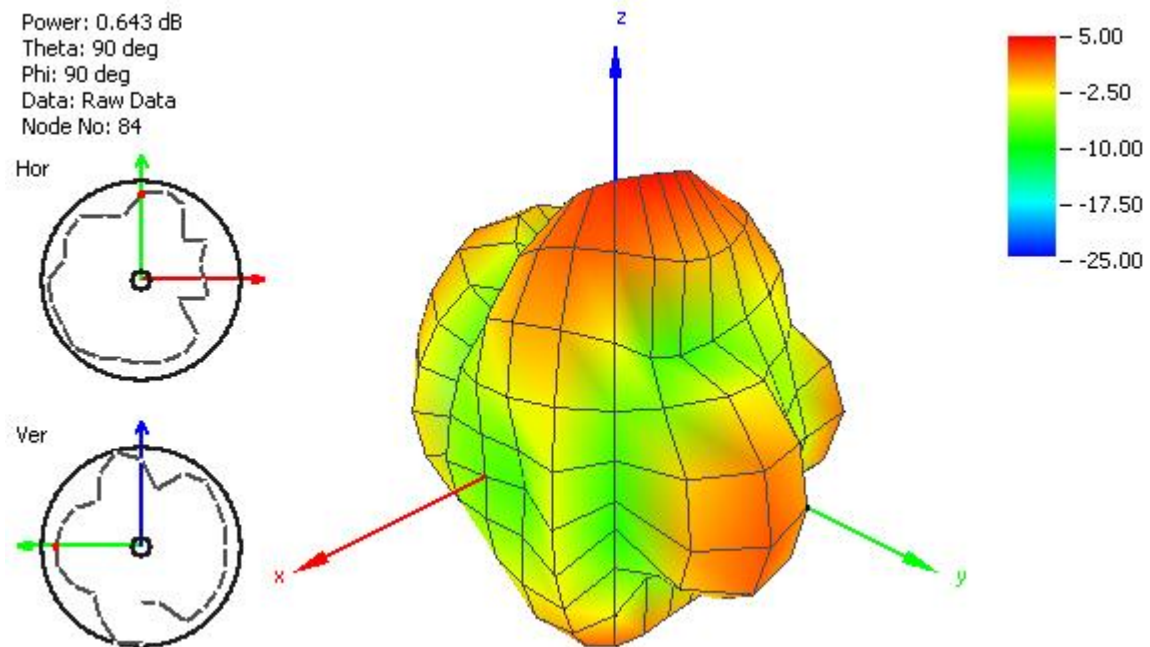

Figure 18. Radiation Pattern at 3600 MHz of FXUB66 UWB Antenna.

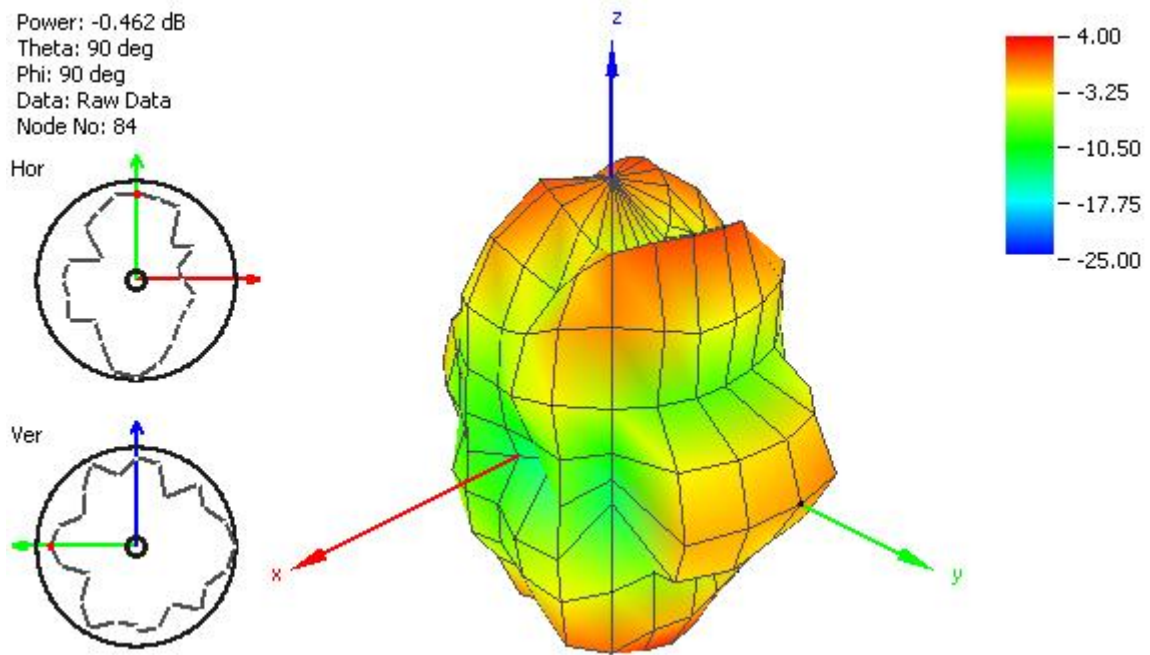

Figure 19. Radiation Pattern at 5500 MHz of FXUB66 UWB Antenna.

5. Mechanical Drawings (Unit: mm)

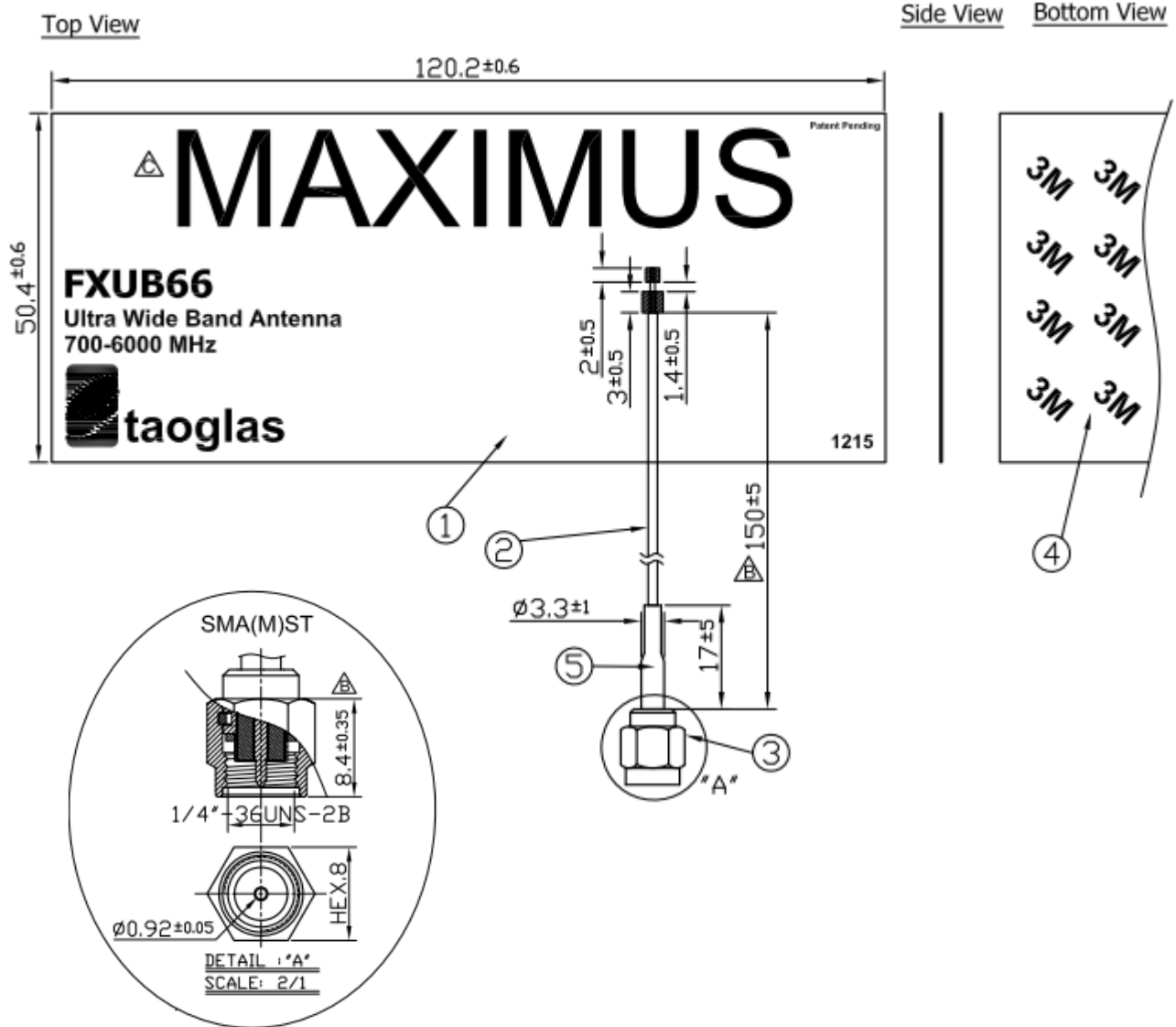
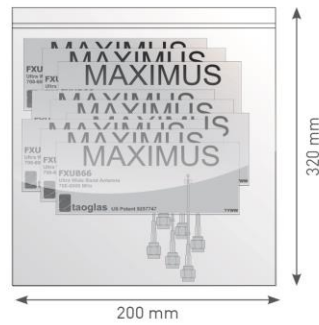
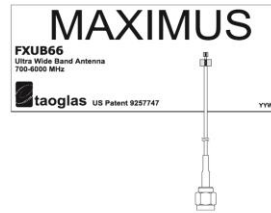

Figure 20. Mechanical drawing of FXUB66 UWB Antenna.

6. Packaging

100pcs FXUB66.01.0150C per PE Bag
 Bag Dimensions - 320 x 200mm
 Weight - 638g



1,000 pcs FXUB66.01.0150C per carton
 Carton - 360 x 310 x 160mm
 Weight - 3.9Kg

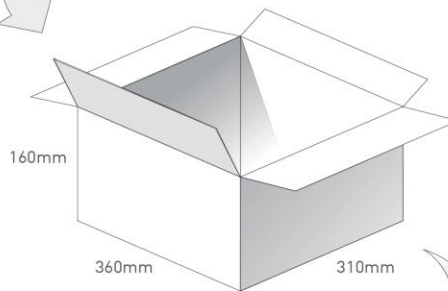

Pallet Dimensions 1200 x 1000 x 1480mm
 72 Cartons per Pallet
 9 Cartons per layer
 8 Layers

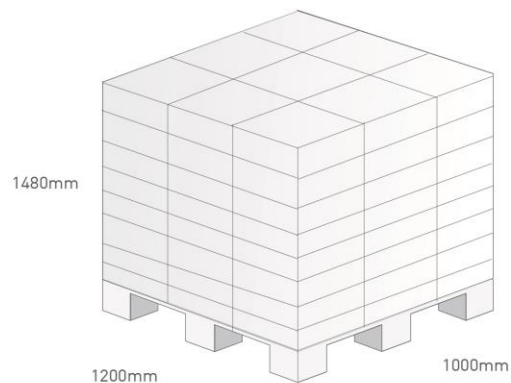



Taoglas makes no warranties based on the accuracy or completeness of the contents of this document and reserves the right to make changes to specifications and product descriptions at any time without notice. Taoglas reserves all rights to this document and the information contained herein.

Reproduction, use or disclosure to third parties without express permission is strictly prohibited.

Copyright © Taoglas Ltd.