

ATOM SPK

SKU:K054



Description

ATOM SPK is an audio player that adapts to the ATOM master control, with built-in I2S digital audio interface power amplifier chip NS4168, with automatic sampling rate detection, adaptive functions, and can effectively prevent audio signal distortion. Integrated TFCard card slot is convenient for saving and reading audio files. Provide 3.5mm headphone jack and external speaker interface, users can play audio through external headphones or speakers.

ATOM SPK Some IO conflict with ATOM Matrix's built-in hardware, so ATOM SPK is only applicable to ATOM LITE

Product Features

- Power amplifier chip NS4168
- I2S serial digital audio input interface
- Support a wide range of sampling rates: 8kHz~96kHz
- Automatic sampling rate detection, adaptive function
- TFCard slot
- Headphone jack
- Speaker interface

Contains

- 1x ATOM Lite
- 1x ATOM SPK
- 1x 1W Speaker
- 1x M2 Allen key
- 1x M2*8 cup head machine screw
- 1x TYPE-C USB Cable(20cm)

Application

- Audio player
- Bluetooth audio
- WiFi speaker

Specifications

Specifications	Parameters
Power amplifier chip	NS4168
Amplifier output power	1W(VDD=3.3V)
Headphone jack	3.5mm
Speaker interface	1.25mm-2P
Speaker power	1W
Net weight	18.6g
Gross weight	37g
Product size	24*48*18mm
Package size	54*54*20mm

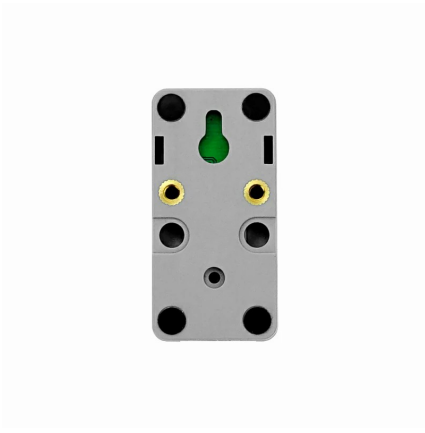

| EasyLoader

EasyLoader is a simple and fast program burner, which has a built-in product-related case program, which can be burned to the main control through simple steps to perform a series of functional verification.

2, Select COM

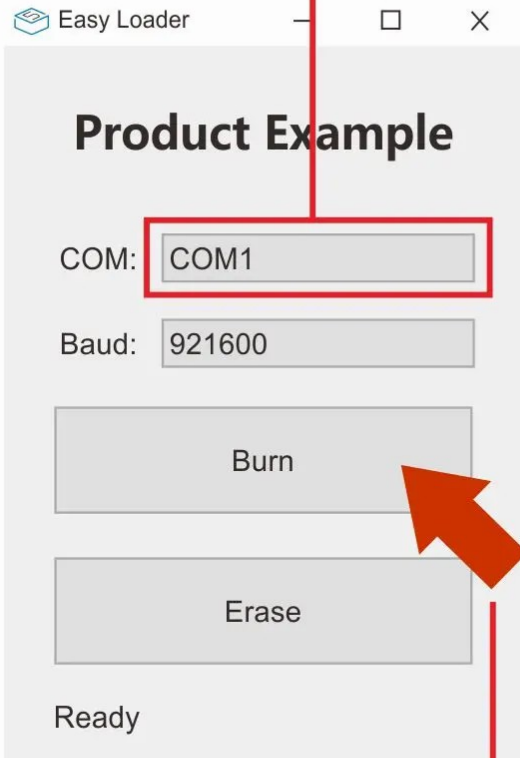

1, Downloads

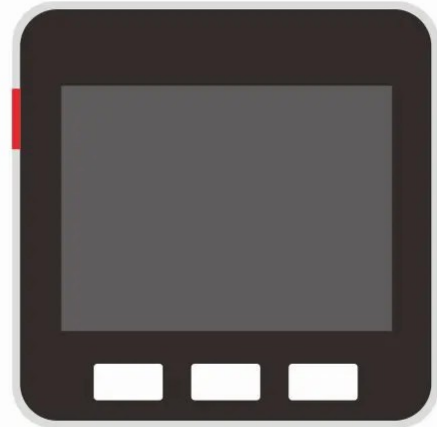
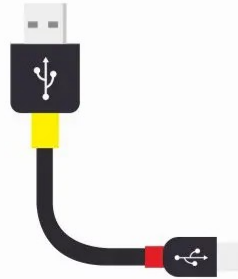

Core \ M5StickC \ M5StickV...

3, Burn Firmware

Windows

| Related Links

- **Datasheet**
 - [NS4168](#)

| Pin mapping

- TFCard

ATOM G23 G33 G19
TFCard SCK MISO MOSI

- NS4168

ATOM G22 G21 G25
NS4168 BLCK LRCLK DATA

| Schematic

NS4168 is a mono audio power amplifier(the right channel is used by default in the ATOM SPK hardware design)

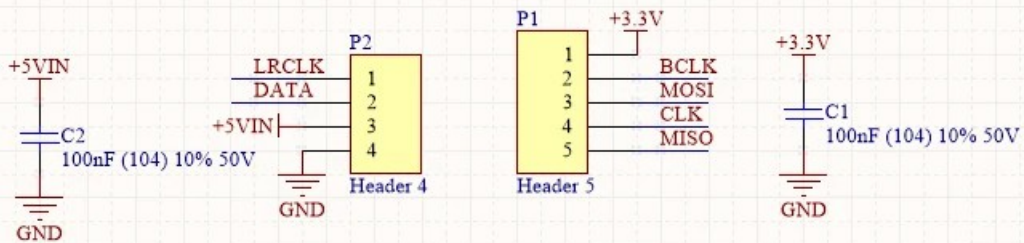
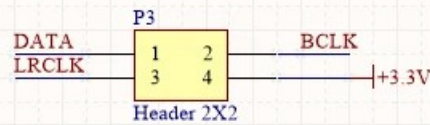
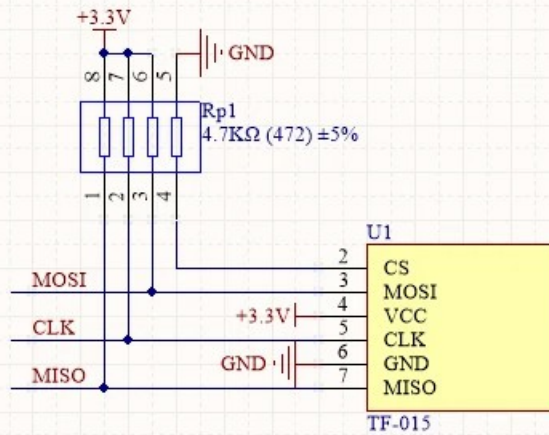

| Example

Arduino

ATOM SPK Play RawPCM ATOM SPK Play MP3 From TFCard

Use ATOM SPK to play RawPCM files or MP3, the case is suitable for master: ATOM Lite.

```
//Init I2S param(__rate: I2S sampling rate)
```

```
bool begin(int __rate = 44100);
```

```
//Play RawPCM param(__audioPtr: audio data pointer, __size: data length, freeFlag: whether to release the memory, __ticksToWait: allow the maximum duration of blocked playback)
```

```
size_t playRAW( const uint8_t* __audioPtr, size_t __size, bool __modal = false, bool freeFlag = true, TickType_t __ticksToWait = portMAX_DELAY );
```

```
//play Beep param(__freq: frequency, __timems: play market, __maxval: maximum volume, __modal: asynchronous or not)
```

```
size_t playBeep( int __freq = 2000, int __timems = 200, int __maxval = 10000, bool __modal = false );
```