

## Features

- Very Low Forward Voltage Drop
- Guard Ring Construction for Transient Protection
- High Conductance
- **Lead, Halogen and Antimony Free, RoHS Compliant "Green" Device (Notes 2, 4 and 5)**

## Mechanical Data

- Case: SOD-323
- Case Material: Molded Plastic. "Green" Molding Compound. UL Flammability Classification Rating 94V-0
- Moisture Sensitivity: Level 1 per J-STD-020D
- Terminal Connections: Cathode Band
- Terminals: Finish – Matte Tin Annealed Over Alloy 42 Leadframe. Solderable per MIL-STD-202, Method 208
- Marking Information: See Page 2
- Ordering Information: See Page 2
- Weight: 0.004 grams (approximate)



Top View

## Maximum Ratings @ $T_A = 25^\circ\text{C}$ unless otherwise specified

Single phase, half wave, 60Hz, resistive or inductive load.  
For capacitance load, derate current by 20%.

| Characteristic  | Symbol       | Value | Unit |
|---|--------------|-------|------|
| Peak Repetitive Reverse Voltage   | $V_{RRM}$    | 30    | V    |
| Working Peak Reverse Voltage  | $V_{RWM}$    |       |      |
| DC Blocking Voltage   | $V_R$        |       |      |
| RMS Reverse Voltage   | $V_{R(RMS)}$ | 21    | V    |
| Average Rectified Output Current  | $I_O$        | 1     | A    |
| Non-Repetitive Peak Forward Surge Current<br>8.3ms Single Half Sine-Wave Superimposed on Rated Load | $I_{FSM}$    | 9     | A    |

## Thermal Characteristics

| Characteristic  | Symbol          | Value       | Unit                      |
|---|-----------------|-------------|---------------------------|
| Power Dissipation (Note 1)                              | $P_D$           | 200         | mW                        |
| Typical Thermal Resistance Junction to Ambient (Note 1) | $R_{\theta JA}$ | 426         | $^\circ\text{C}/\text{W}$ |
| Operating and Storage Temperature Range                 | $T_J, T_{STG}$  | -65 to +125 | $^\circ\text{C}$          |

## Electrical Characteristics @ $T_A = 25^\circ\text{C}$ unless otherwise specified

| Characteristic                     | Symbol      | Min | Typ | Max        | Unit          | Test Conditions                           |
|------------------------------------|-------------|-----|-----|------------|---------------|---|
| Reverse Breakdown Voltage (Note 3) | $V_{(BR)R}$ | 30  | —   | —          | V             | $I_R = 500\mu\text{A}$                    |
| Forward Voltage Drop               | $V_F$       | —   | —   | 360<br>485 | mV            | $I_F = 100\text{mA}$<br>$I_F = 1\text{A}$ |
| Leakage Current (Note 3)           | $I_R$       | —   | —   | 100        | $\mu\text{A}$ | $V_R = 20\text{V}$                        |
| Total Capacitance                  | $C_T$       | —   | 22  | —          | pF            | $f = 1\text{MHz}, V_R = 10\text{VDC}$     |

- Notes:
1. Part mounted on FR-4 PC board with recommended pad layout, which can be found on our website at <http://www.diodes.com/datasheets/ap02001.pdf>.
  2. Diodes Inc's "Green" policy can be found on our website at [http://www.diodes.com/products/lead\\_free/index.php](http://www.diodes.com/products/lead_free/index.php).
  3. Short duration pulse test used to minimize self-heating effect.
  4. No purposefully added lead. Halogen and Antimony Free.
  5. Product manufactured with Green Molding Compound and does not contain Halogens or  $\text{Sb}_2\text{O}_3$  Fire Retardants.

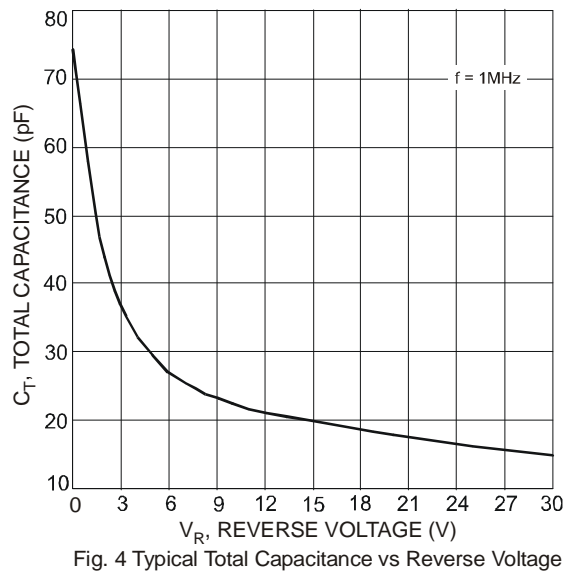
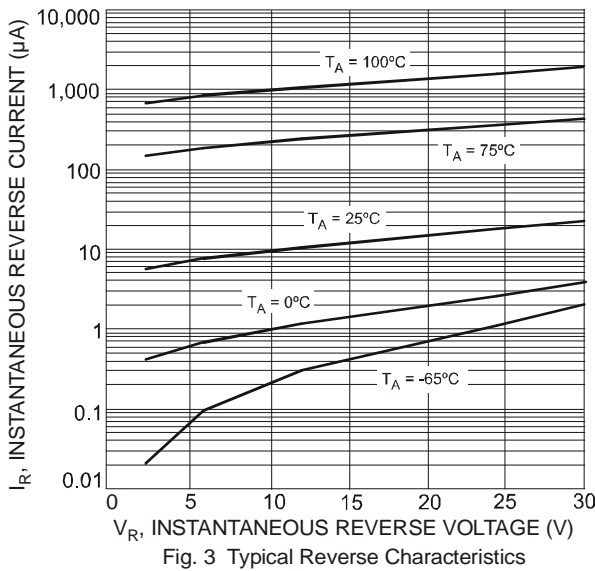
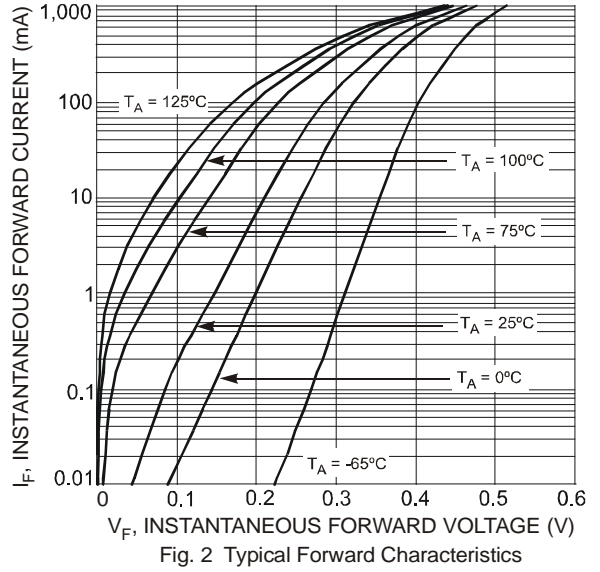
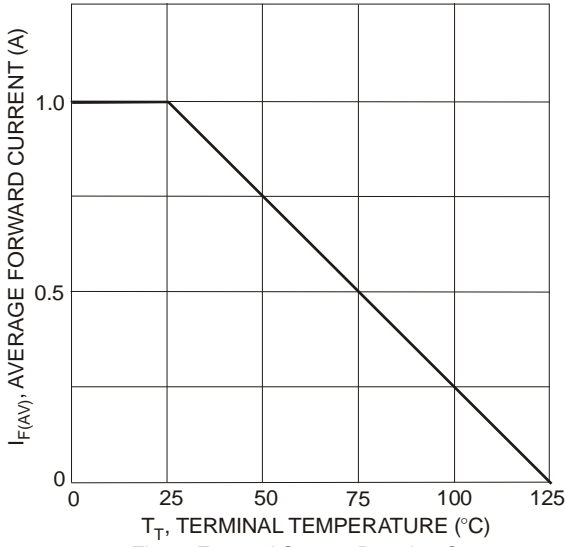

**Ordering Information** (Note 6)

| Part Number  | Case    | Packaging        |
|--------------|---------|------------------|
| SDM100K30L-7 | SOD-323 | 3000/Tape & Reel |

Notes: 6. For packaging details, go to our website at <http://www.diodes.com/datasheets/ap02007.pdf>.

**Marking Information**

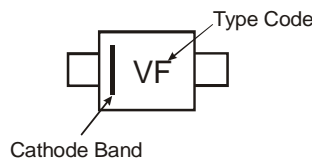

**Package Outline Dimensions**

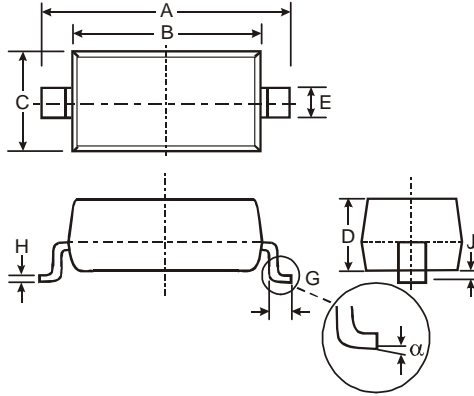

| SOD-323              |              |      |
|----------------------|--------------|------|
| Dim                  | Min          | Max  |
| A                    | 2.30         | 2.70 |
| B                    | 1.60         | 1.80 |
| C                    | 1.20         | 1.40 |
| D                    | 1.05 Typical |      |
| E                    | 0.25         | 0.35 |
| G                    | 0.20         | 0.40 |
| H                    | 0.10         | 0.15 |
| J                    | 0.00         | 0.10 |
| α                    | 0°           | 8°   |
| All Dimensions in mm |              |      |

**Suggested Pad Layout**

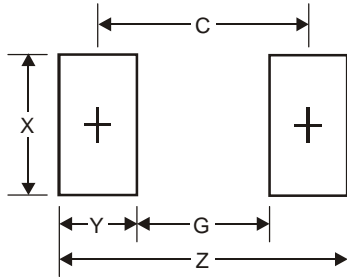

| Dimensions | Value (in mm) |
|------------|---------------|
| Z          | 3.75          |
| G          | 1.05          |
| X          | 0.65          |
| Y          | 1.35          |
| C          | 2.40          |

**IMPORTANT NOTICE**

Diodes Incorporated and its subsidiaries reserve the right to make modifications, enhancements, improvements, corrections or other changes without further notice to any product herein. Diodes Incorporated does not assume any liability arising out of the application or use of any product described herein; neither does it convey any license under its patent rights, nor the rights of others. The user of products in such applications shall assume all risks of such use and will agree to hold Diodes Incorporated and all the companies whose products are represented on our website, harmless against all damages.

**LIFE SUPPORT**

Diodes Incorporated products are not authorized for use as critical components in life support devices or systems without the expressed written approval of the President of Diodes Incorporated.