

PLEASE CHECK WWW.MOLEX.COM FOR LATEST PART INFORMATION

Part Number: [0533750310](#)
Status: **Active**
Overview: Mini-Lock Wire-to-Board Connector System
Description: 2.50mm Pitch Mini-Lock Wire-to-Board Header, Vertical, Friction and Positive Lock, 3 Circuits

Documents:

3D Model	Packaging Specification 533759200-SPK-200 (PDF)
Drawing (PDF)	RoHS Certificate of Compliance (PDF)
Product Specification PS-51103-005-001 (PDF)	Product Literature (PDF)
Product Specification PS-51163-002-001 (PDF)	

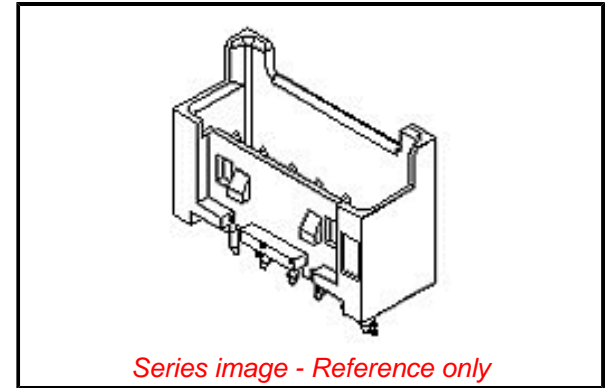

Agency Certification

CSA	LR19980
UL	E29179

General

Product Family	PCB Headers
Series	53375
Application	Signal, Wire-to-Board
Overview	Mini-Lock Wire-to-Board Connector System
Product Literature Order No	987651-9241
Product Name	Mini-Lock
UPC	800753563612

Physical

Breakaway	No
Circuits (Loaded)	3
Circuits (maximum)	3
Color - Resin	Natural
Durability (mating cycles max)	30
First Mate / Last Break	No
Flammability	94V-0
Glow-Wire Capable	No
Guide to Mating Part	No
Keying to Mating Part	None
Lock to Mating Part	Yes
Material - Plating Mating	Tin
Material - Plating Termination	Tin
Material - Resin	Polyester
Net Weight	469.000/mg
Number of Rows	1
Orientation	Vertical
PC Tail Length	3.40mm
PCB Locator	Yes
PCB Retention	Yes
PCB Thickness - Recommended	1.60mm
Packaging Type	Bag
Pitch - Mating Interface	2.50mm
Polarized to Mating Part	Yes
Polarized to PCB	Yes
Shrouded	Fully
Stackable	No
Surface Mount Compatible (SMC)	No
Temperature Range - Operating	-40° to +105°C
Termination Interface: Style	Through Hole

EU ELV

Not Relevant

EU RoHS

Compliant

REACH SVHC

Not Contained Per -
ED/61/2018 (27 June
2018)

Halogen-Free

Status

Not Low-Halogen

For more information, please visit [Contact US](#)

China ROHS

ELV

RoHS Phthalates

China RoHS

Green Image

Not Relevant

Not Contained

Search Parts in this Series

[53375 Series](#)

Mates With

Mini-Lock Wire-to-Board and Wire-to-Wire
Crimp Terminal [51103](#) , [51102](#) , [51163](#)

Electrical

Current - Maximum per Contact

3.0A

Voltage - Maximum

250V

Material Info**Reference - Drawing Numbers**

Packaging Specification

533759200-SPK-200

Product Specification

PS-51103-005-001, PS-51163-002-001

Sales Drawing

SD-53375-001

This document was generated on 10/02/2018

PLEASE CHECK WWW.MOLEX.COM FOR LATEST PART INFORMATION