

ATE Spring Probes

Two-Part Test Probes for 2.54mm Pitch

- ❖ For use with probes with 18.5mm body length, as shown on previous page.
- ❖ Sleeve can be assembled as either interference fit to a test jig, and wire attached to the rear bore, or clearance fit and soldered to a PCB for electrical connection.

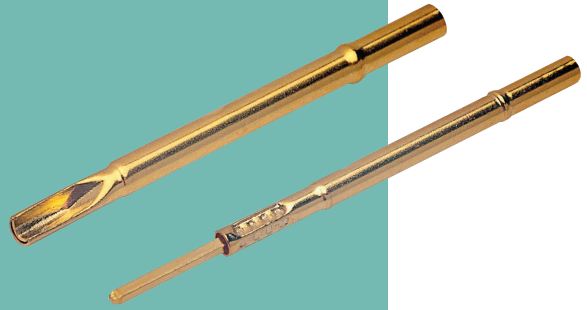

SPRING PROBES

SOLDER CUP SLEEVE

- ❖ Suitable for use with 22 to 30AWG wire.

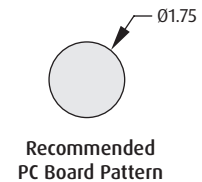
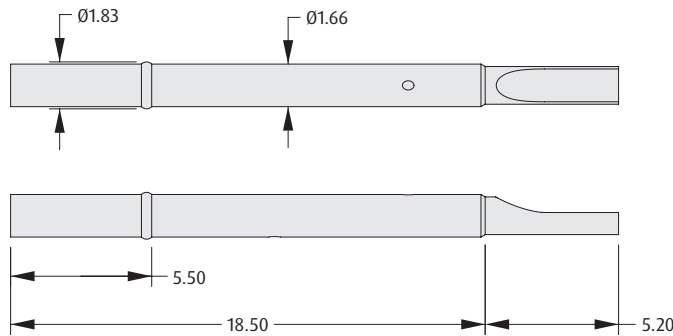

ORDER CODE
S25-022

WIRE-WRAP TAIL SLEEVE

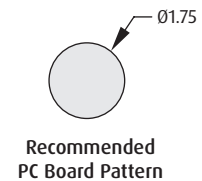
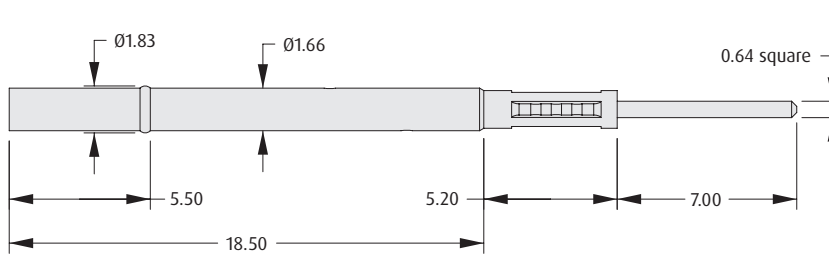

ORDER CODE
S25-212

SOLDER BARREL SLEEVE

- ❖ Suitable for use with 22 to 30AWG wire.

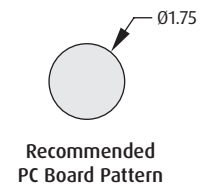
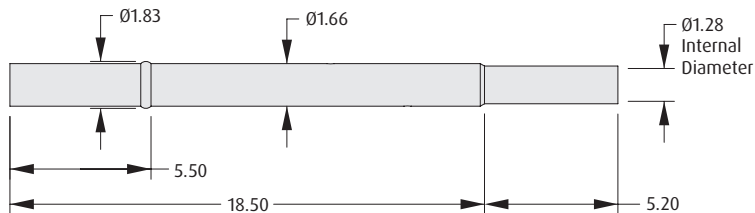

ORDER CODE
S25-512

All dimensions in mm.