

SIPMOS® Small-Signal Transistor

- N channel
- Enhancement mode
- Avalanche rated
- $V_{GS(th)} = 2.1 \dots 4.0 \text{ V}$
- Pb-free lead plating; RoHS compliant
- Qualified according to AEC Q101
- Halogen-free according to IEC61249-2-21

drain pins 2, 4

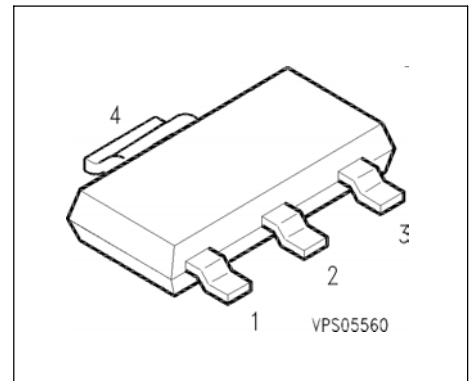

Pin 1	Pin 2	Pin 3	Pin 4
G	D	S	D



Type	V_{DS}	I_D	$R_{DS(on)}$	Package	Marking
BSP298	400 V	0.5 A	3 Ω	PG-SOT223	BSP298

Type	Pb-free	Tape and Reel Information	Packaging
BSP298	Yes	H6327	Dry

Maximum Ratings

Parameter	Symbol	Values	Unit
Continuous drain current $T_A = 26 \text{ }^\circ\text{C}$	I_D	0.5	A
DC drain current, pulsed $T_A = 25 \text{ }^\circ\text{C}$	I_{Dpuls}	2	A
Avalanche energy, single pulse $I_D = 1.35 \text{ A}$, $V_{DD} = 50 \text{ V}$, $R_{GS} = 25 \text{ } \Omega$ $L = 125 \text{ mH}$, $T_j = 25 \text{ }^\circ\text{C}$	E_{AS}	130	mJ
Gate source voltage	V_{GS}	± 20	V
Power dissipation $T_A = 25 \text{ }^\circ\text{C}$	P_{tot}	1.8	W
ESD Class JESD22-A114-HBM		Class 1b	

Maximum Ratings

Parameter	Symbol	Values	Unit
Chip or operating temperature	T_j	-55 ... + 150	°C
Storage temperature	T_{stg}	-55 ... + 150	
Thermal resistance, chip to ambient air	R_{thJA}	≤ 70	K/W
Thermal resistance, junction-soldering point ¹⁾	R_{thJS}	≤ 10	
DIN humidity category, DIN 40 040		E	
IEC climatic category, DIN IEC 68-1		55 / 150 / 56	

1) Transistor on epoxy pcb 40 mm x 40 mm x 1,5 mm with 6 cm² copper area for drain connection

Electrical Characteristics, at $T_j = 25^\circ\text{C}$, unless otherwise specified

Parameter	Symbol	Values			Unit
		min.	typ.	max.	

Static Characteristics

Drain- source breakdown voltage $V_{GS} = 0 \text{ V}, I_D = 0.25 \text{ mA}, T_j = 0^\circ\text{C}$	$V_{(BR)DSS}$	400	-	-	V
Gate threshold voltage $V_{GS}=V_{DS}, I_D = 1 \text{ mA}$	$V_{GS(th)}$	2.1	3	4	
Zero gate voltage drain current $V_{DS} = 400 \text{ V}, V_{GS} = 0 \text{ V}, T_j = 25^\circ\text{C}$ $V_{DS} = 400 \text{ V}, V_{GS} = 0 \text{ V}, T_j = 125^\circ\text{C}$	I_{DSS}	-	0.1 10	1 100	μA
Gate-source leakage current $V_{GS} = 20 \text{ V}, V_{DS} = 0 \text{ V}$	I_{GSS}	-	10	100	
Drain-Source on-state resistance $V_{GS} = 10 \text{ V}, I_D = 0.5 \text{ A}$	$R_{DS(on)}$	-	2.2	3	Ω

Electrical Characteristics, at $T_j = 25^\circ\text{C}$, unless otherwise specified

Parameter	Symbol	Values			Unit
		min.	typ.	max.	
Dynamic Characteristics					
Transconductance $V_{DS} \geq 2 \cdot I_D \cdot R_{DS(on)max}$, $I_D = 0.5 \text{ A}$	g_{fs}	0.5	1.2	-	S
Input capacitance $V_{GS} = 0 \text{ V}$, $V_{DS} = 25 \text{ V}$, $f = 1 \text{ MHz}$	C_{iss}	-	300	400	pF
Output capacitance $V_{GS} = 0 \text{ V}$, $V_{DS} = 25 \text{ V}$, $f = 1 \text{ MHz}$	C_{oss}	-	50	75	
Reverse transfer capacitance $V_{GS} = 0 \text{ V}$, $V_{DS} = 25 \text{ V}$, $f = 1 \text{ MHz}$	C_{rss}	-	20	30	
Turn-on delay time $V_{DD} = 30 \text{ V}$, $V_{GS} = 10 \text{ V}$, $I_D = 0.3 \text{ A}$ $R_{GS} = 50 \Omega$	$t_{d(on)}$	-	10	15	ns
Rise time $V_{DD} = 30 \text{ V}$, $V_{GS} = 10 \text{ V}$, $I_D = 0.3 \text{ A}$ $R_{GS} = 50 \Omega$	t_r	-	25	40	
Turn-off delay time $V_{DD} = 30 \text{ V}$, $V_{GS} = 10 \text{ V}$, $I_D = 0.3 \text{ A}$ $R_{GS} = 50 \Omega$	$t_{d(off)}$	-	30	40	
Fall time $V_{DD} = 30 \text{ V}$, $V_{GS} = 10 \text{ V}$, $I_D = 0.3 \text{ A}$ $R_{GS} = 50 \Omega$	t_f	-	20	30	

Electrical Characteristics, at $T_j = 25^\circ\text{C}$, unless otherwise specified

Parameter	Symbol	Values			Unit
		min.	typ.	max.	

Reverse Diode

Inverse diode continuous forward current $T_A = 25^\circ\text{C}$	I_S	-	-	0.5	A
Inverse diode direct current, pulsed $T_A = 25^\circ\text{C}$	I_{SM}	-	-	2	
Inverse diode forward voltage $V_{GS} = 0\text{ V}$, $I_F = 1\text{ A}$, $T_j = 25^\circ\text{C}$	V_{SD}	-	0.95	1.2	V
Reverse recovery time $V_R = 100\text{ V}$, $I_F = I_S$, $di_F/dt = 100\text{ A}/\mu\text{s}$	t_{rr}	-	300	-	ns
Reverse recovery charge $V_R = 100\text{ V}$, $I_F = I_S$, $di_F/dt = 100\text{ A}/\mu\text{s}$	Q_{rr}	-	2.5	-	μC

Power dissipation

$$P_{tot} = f(T_A)$$

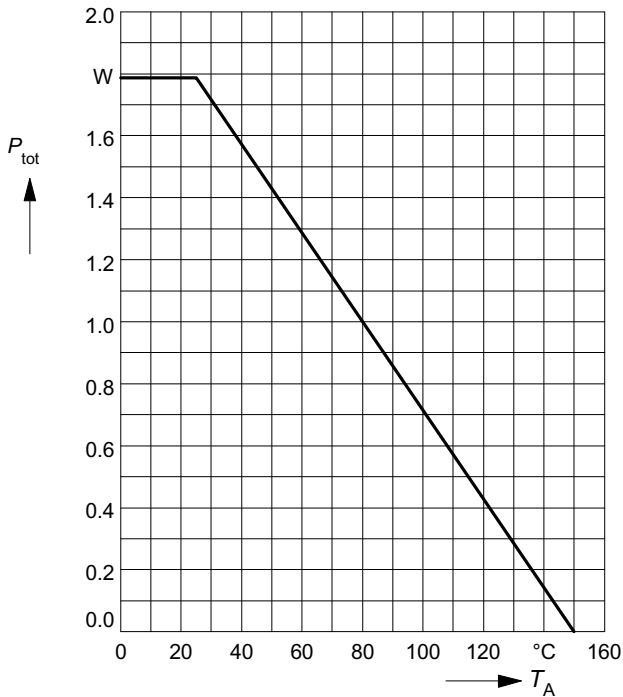

Drain current

$$I_D = f(T_A)$$

parameter: $V_{GS} \geq 10 \text{ V}$

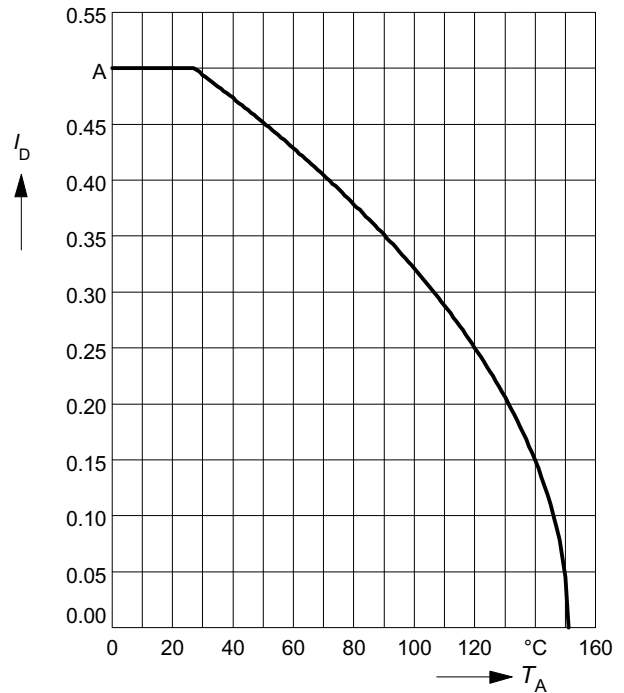

Safe operating area $I_D = f(V_{DS})$

parameter : $D = 0, T_C = 25^\circ\text{C}$

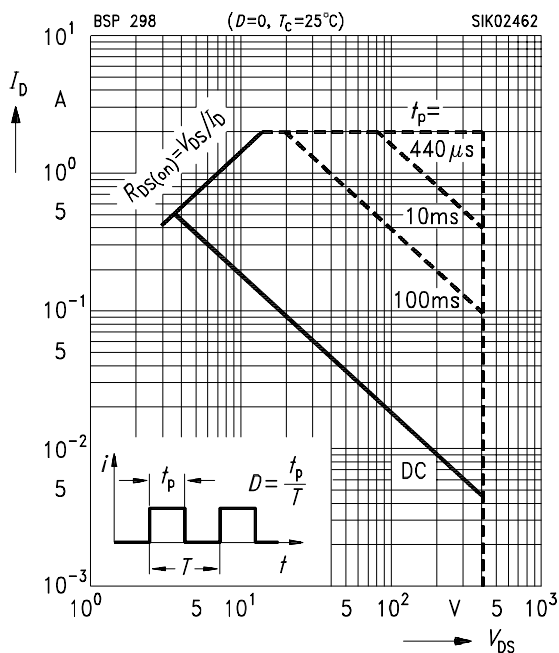

Transient thermal impedance

$$Z_{th\text{JA}} = f(t_p)$$

parameter: $D = t_p / T$

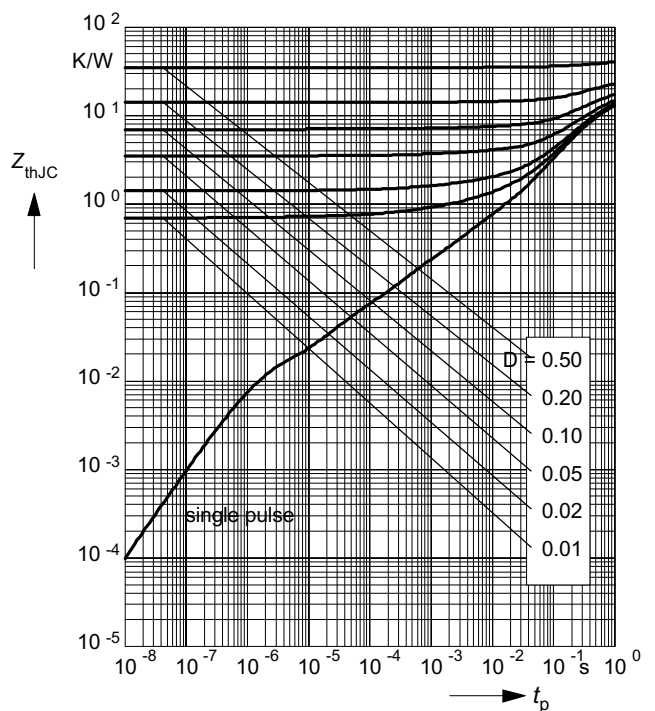

Typ. output characteristics

$I_D = f(V_{DS})$

parameter: $t_p = 80 \mu s$, $T_j = 25 \text{ }^\circ\text{C}$

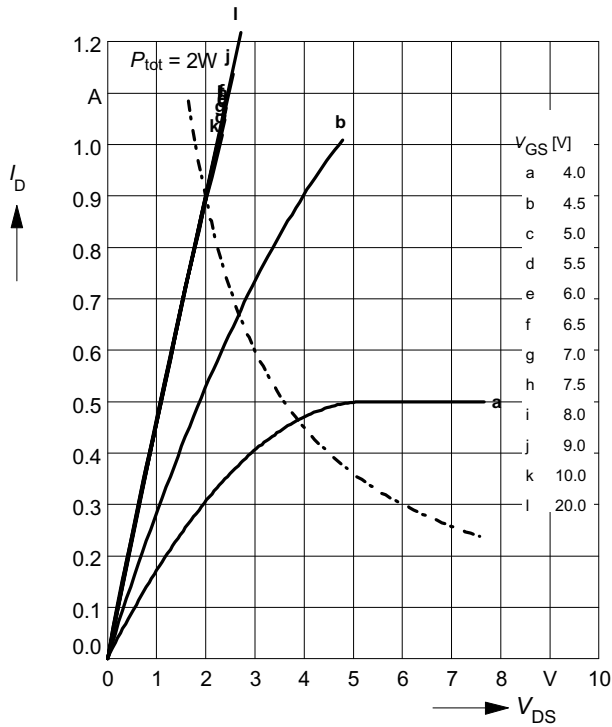

Typ. drain-source on-resistance

$R_{DS(on)} = f(I_D)$

parameter: $t_p = 80 \mu s$, $T_j = 25 \text{ }^\circ\text{C}$

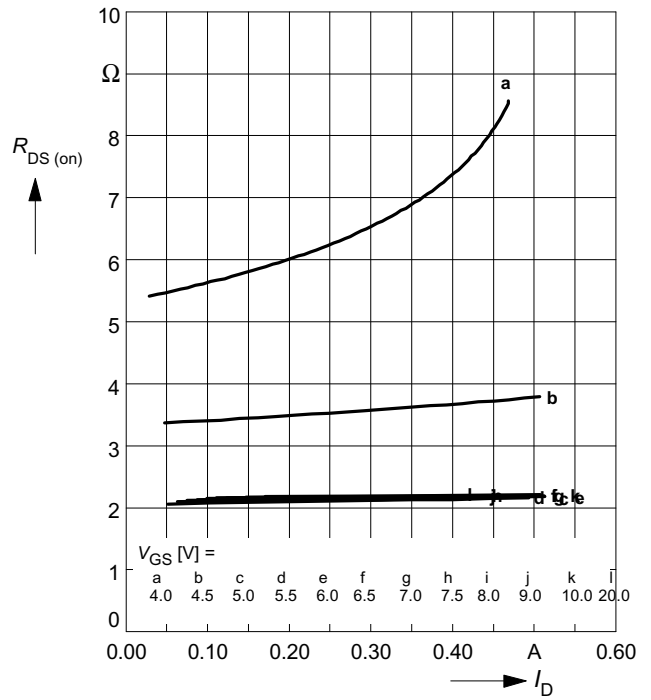

Typ. transfer characteristics $I_D = f(V_{GS})$

parameter: $t_p = 80 \mu s$

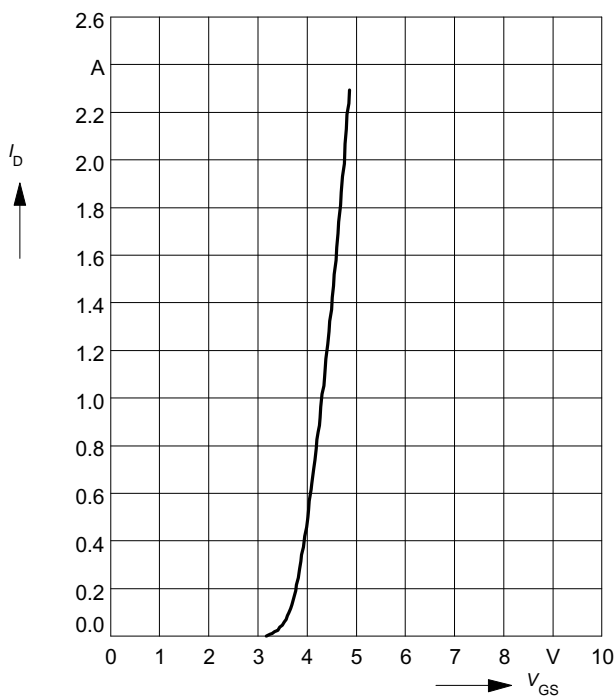

Typ. forward transconductance $g_{fs} = f(I_D)$

parameter: $t_p = 80 \mu s$,

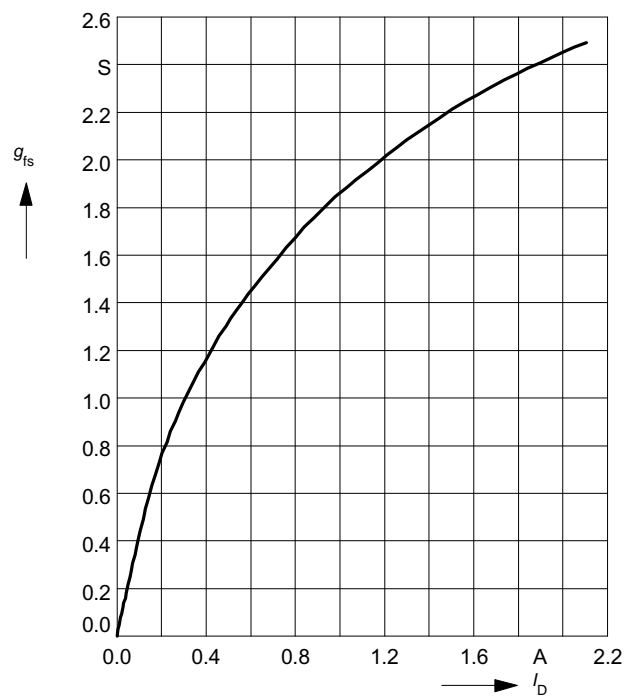

Drain-source on-resistance

$$R_{DS(on)} = f(T_j)$$

parameter: $I_D = 0.5 \text{ A}$, $V_{GS} = 10 \text{ V}$

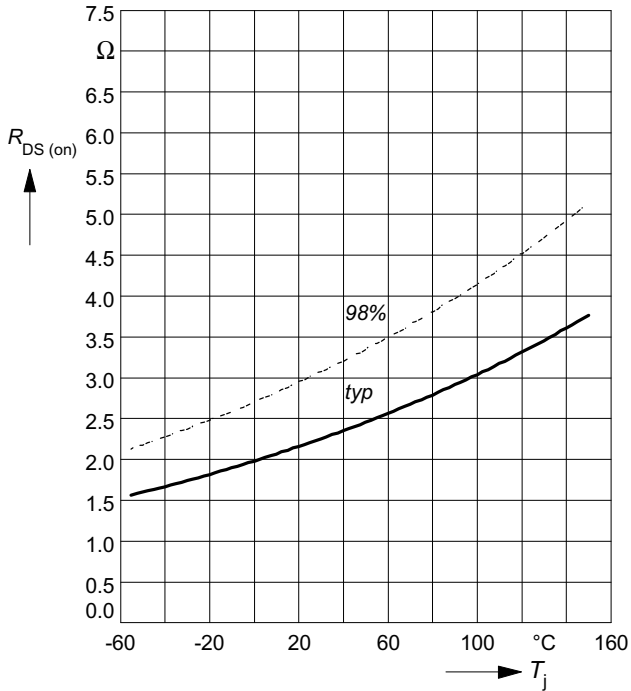

Gate threshold voltage

$$V_{GS(th)} = f(T_j)$$

parameter: $V_{GS} = V_{DS}$, $I_D = 1 \text{ mA}$

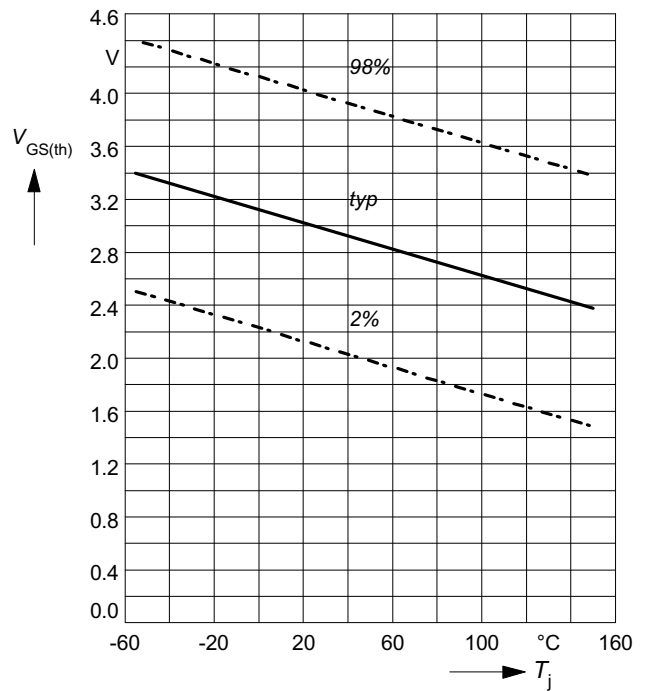

Typ. capacitances

$$C = f(V_{DS})$$

parameter: $V_{GS}=0\text{V}$, $f = 1 \text{ MHz}$

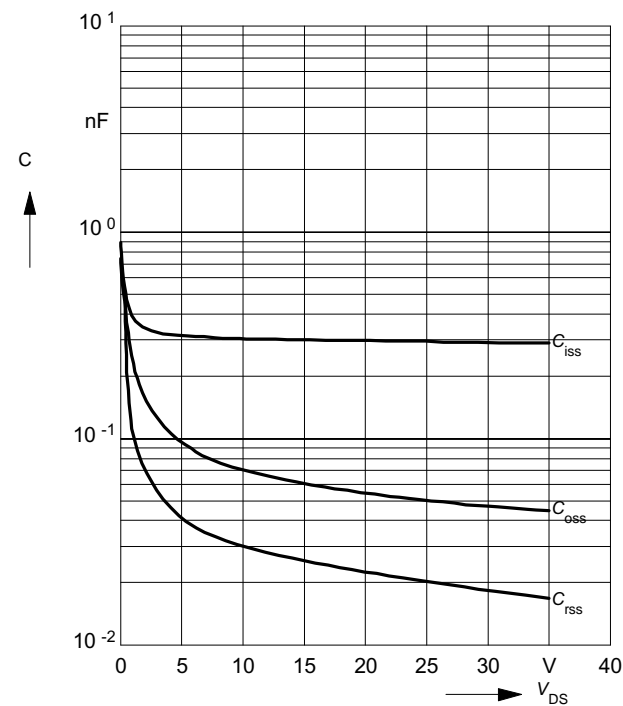

Forward characteristics of reverse diode

$$I_F = f(V_{SD})$$

parameter: $T_j, t_p = 80 \mu\text{s}$

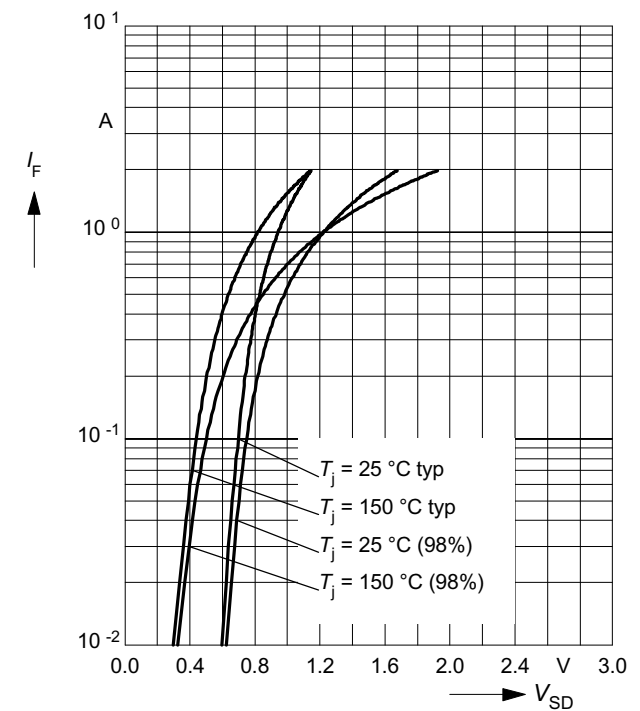

Avalanche energy $E_{AS} = f(T_j)$
 parameter: $I_D = 1.35 \text{ A}$, $V_{DD} = 50 \text{ V}$
 $R_{GS} = 25 \Omega$, $L = 125 \text{ mH}$

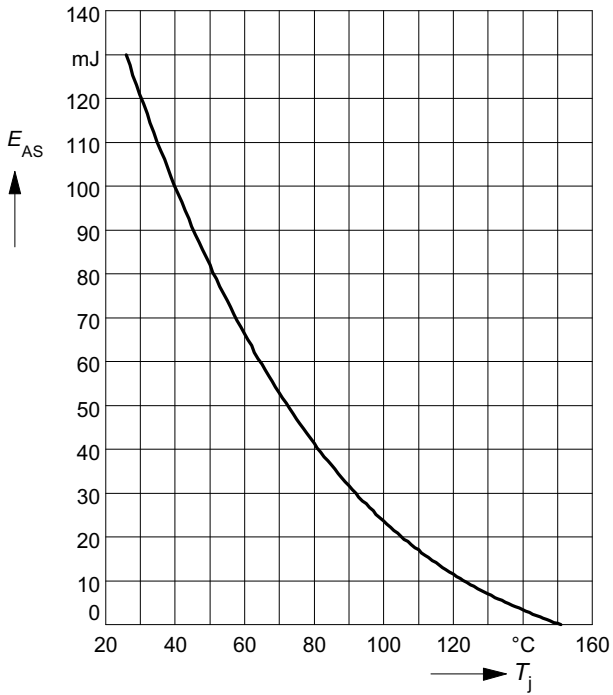

Drain-source breakdown voltage
 $V_{(BR)DSS} = f(T_j)$

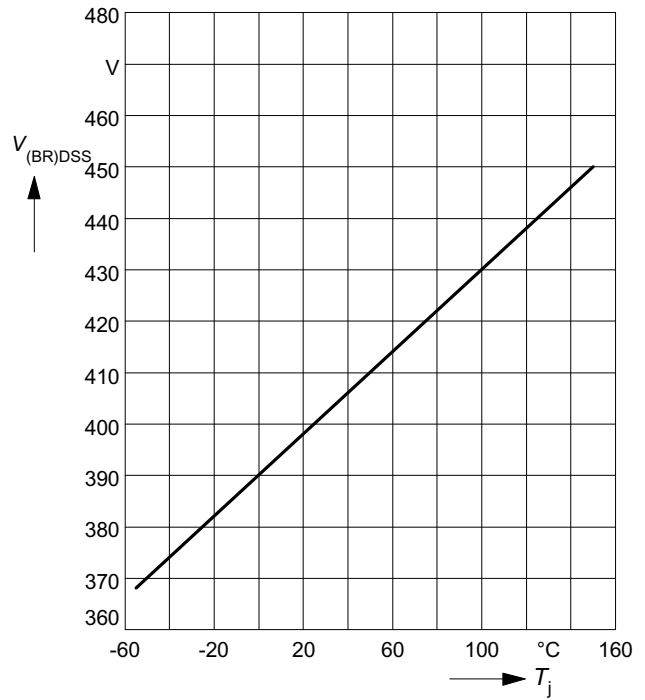

Safe operating area $I_D = f(V_{DS})$
 parameter : $D = 0.01$, $T_C = 25^\circ\text{C}$

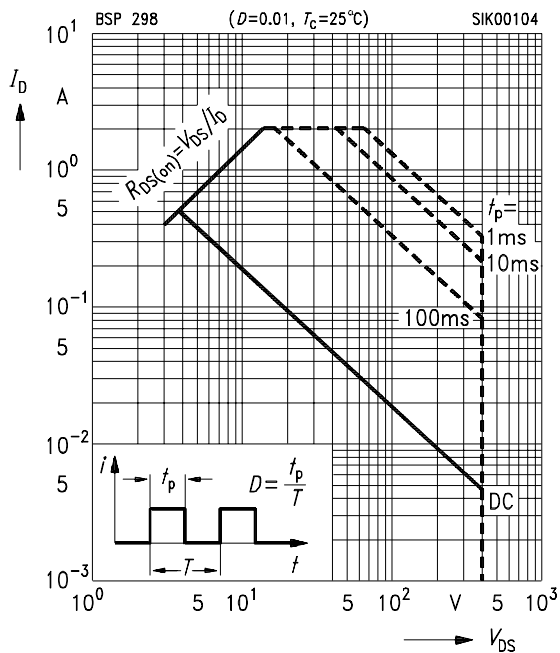

Package outlines

SOT-223

Dimensions in mm

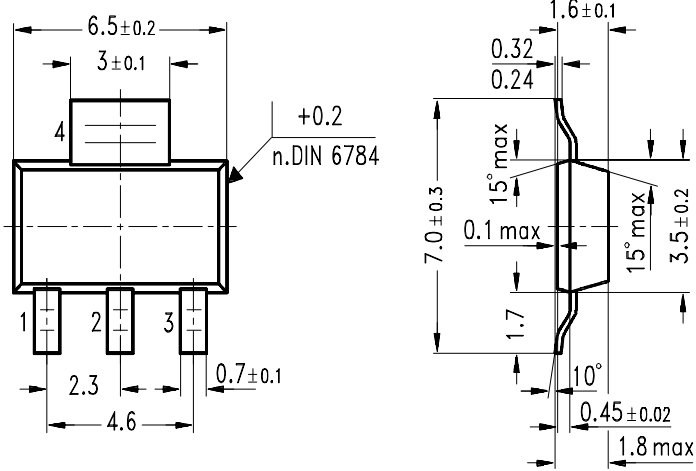

GPS05560

Published by
Infineon Technologies AG
81726 Munich, Germany
© 2008 Infineon Technologies AG
All Rights Reserved.

Legal Disclaimer

The information given in this document shall in no event be regarded as a guarantee of conditions or characteristics. With respect to any examples or hints given herein, any typical values stated herein and/or any information regarding the application of the device, Infineon Technologies hereby disclaims any and all warranties and liabilities of any kind, including without limitation, warranties of non-infringement of intellectual property rights of any third party.

Information

For further information on technology, delivery terms and conditions and prices, please contact the nearest Infineon Technologies Office (www.infineon.com).

Warnings

Due to technical requirements, components may contain dangerous substances. For information on the types in question, please contact the nearest Infineon Technologies Office. Infineon Technologies components may be used in life-support devices or systems only with the express written approval of Infineon Technologies, if a failure of such components can reasonably be expected to cause the failure of that life-support device or system or to affect the safety or effectiveness of that device or system. Life support devices or systems are intended to be implanted in the human body or to support and/or maintain and sustain and/or protect human life. If they fail, it is reasonable to assume that the health of the user or other persons may be endangered.

Mouser Electronics

Authorized Distributor

Click to View Pricing, Inventory, Delivery & Lifecycle Information:

[Infineon:](#)

[BSP298H6327XUSA1](#)