

# DPM 942-BL

4-20mA Loop Powered Indicator

A loop powered indicator giving an accurate, zero corrected indication of 4-20mA loop current. Calibration is by two 20-turn cermet potentiometers which allow sensitive adjustment of the instrument. For low light viewing, a long life LED backlight is fitted. The meter is housed in a robust carrier, which can be bolted in place or panel mounted using the low profile bezel and clips provided.

- 🔊 19mm (0.75") Digit Height
- 🔊 Programmable Decimal Points
- 🔊 Low Volt Drop
- 🔊 LED Backlight
- 🔊 Simple Screw Terminal Connections



## CUSTOM SCALING

For alternative scaling to the standard 0 - 1000, cut Link 8 and short Link 7. Add two resistors R12 and R13 which will set the basic scale of the meter. The highest practical value for the R12 and R13 series combination is 12R. To select your desired scaling, use the following formula:

$$R12 + R13 = \frac{\text{Full Scale reading at 20mA}}{160}$$

Re-calibrate as necessary.

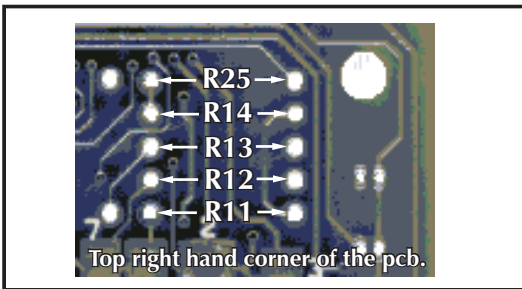

Standard Meter	Stock Number DPM 942-BL			
Specification	Min.	Typ.	Max.	Unit
Accuracy (overall error) *	0.05		0.1	%(±1 count)
Linearity			±1	count
Sample rate		3		samples/sec
Operating temperature range	0		50	°C
Temperature stability		100		ppm/°C
Loop Volt Drop	3.9	4.3	4.8	Vd.c.
Backlight voltage		5		Vd.c.
Backlight current		50		mA

\*To ensure maximum accuracy, re-calibrate periodically.

## CONNECTOR SOURCING GUIDE

<b>METHOD</b>	<b>Screw Terminals - No Connector Required</b>
---------------	--

## DIMENSIONS All dimensions in mm (inches)

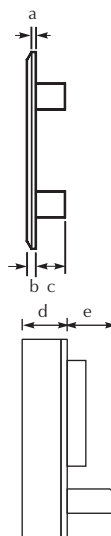
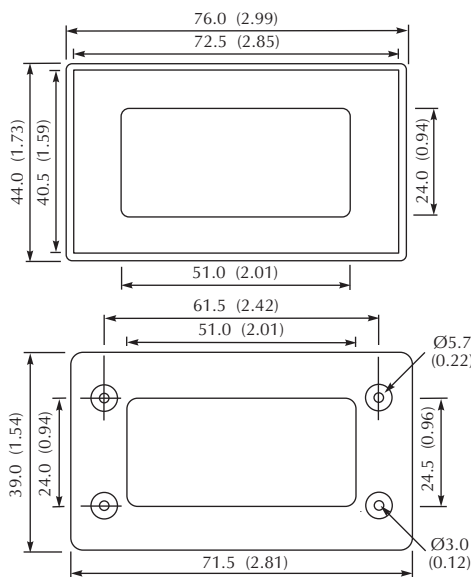

- a. 1.0 (0.04)
- b. 2.0 (0.08)
- c. 6.5 (0.26)
- d. 11.5 (0.45)
- e. 13.0 (0.51)

Panel cut-out 72 x 40 (2.83 x 1.57)  
Maximum panel thickness 3mm (0.12).

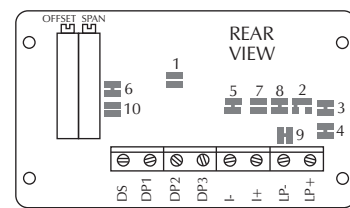

## TERMINAL FUNCTIONS

- LP- Negative power supply to the LED backlighting.
- LP+ Positive power supply to the LED backlighting.  
 Note: The backlighting is intended to be driven from a 5Vd.c. (nom) supply.  
 It is possible to power it from a higher voltage, if an external resistor is fitted - see diagram below.
- I+ Positive current input.
- I- Negative current input.
- DP3 1.000
- DP2 10.00
- DP1 100.0
- DS Decimal Point select. Connect to required DP input to display decimal point.

## CALIBRATION

The meter is supplied calibrated to read 000 for 4mA loop current and 1000 for 20mA.

To re-calibrate:

1. Apply 4mA to I+/I- and adjust 'OFFSET' to read 000.
2. Apply 20mA and adjust 'SPAN' to read 1000.
3. Repeat steps 1 and 2 until there is no more adjustment of 'SPAN' and 'OFFSET' required to give desired readings.

## SAFETY

To comply with the Low Voltage Directive (LVD 93/68/EEC), input voltages to the module's pins must not exceed 60Vdc. If voltages to the measuring inputs do exceed 60Vdc, then fit scaling resistors externally to the module. The user must ensure that the incorporation of the DPM into the user's equipment conforms to the relevant sections of BS EN 61010 (Safety Requirements for Electrical Equipment for Measuring, Control and Laboratory Use).

## VARIOUS OPERATING MODES

ON-BOARD LINKS: In order to quickly and easily change operating modes for different applications, the meter has several "on-board links". They are designed to be easily opened (cut) or shorted (soldered).

The DPM 942-BL is powered from the 4-20mA signal loop and needs no other power supply, except when the LED backlighting is used. Ensure correct polarity when connecting.

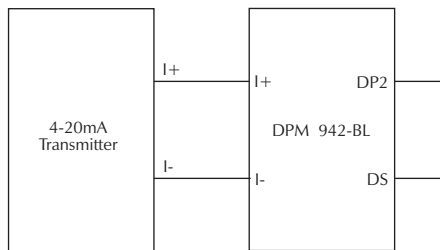
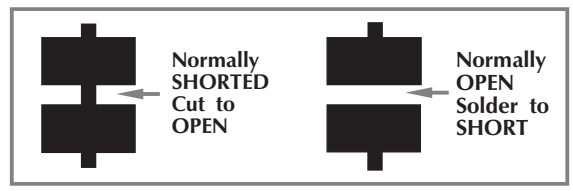

DP2 selected in this example.

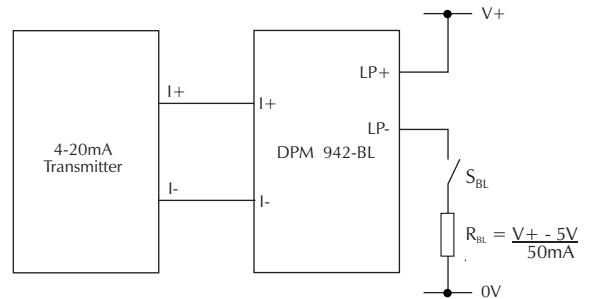

Powering the LED backlighting.  
 The supply voltage for the LED backlighting should be electrically isolated from the 4-20mA current loop.

## PANEL FITTING

