

Click [here](#) for production status of specific part numbers.

MAXM17536

4.5V to 60V, 4A High-Efficiency, DC-DC Step-Down SiP Power Module with Integrated Inductor

General Description

The Himalaya series of voltage regulator ICs and power modules enables cooler, smaller, and simpler power supply solutions. The MAXM17536 is an easy-to-use, step-down power module that combines a switching power supply controller, dual n-channel MOSFET power switches, fully shielded inductor, and the compensation components in a low-profile, thermally-efficient system-in-package (SiP). The device operates over a wide input-voltage range of 4.5V to 60V and delivers up to 4A continuous output current with excellent line and load regulation over an output-voltage range of 0.9V to 12V. The high level of integration significantly reduces design complexity, manufacturing risks, and offers a true plug-and-play power supply solution, reducing time-to-market.

The device can be operated in the pulse-width modulation (PWM), pulse-frequency modulation (PFM), or discontinuous conduction mode (DCM) control schemes.

The MAXM17536 is available in a low-profile, highly thermal-emissive, compact, 29-pin, 9mm x 15mm x 4.32mm SiP package that reduces power dissipation in the package and enhances efficiency. The package is easily soldered onto a printed circuit board and suitable for automated circuit board assembly.

Applications

- Test and Measurement Equipment
- Distributed Supply Regulation
- FPGA and DSP Point-of-Load Regulator
- Base-Station Point-of-Load Regulator
- HVAC and Building Control Systems

Typical Application Circuit

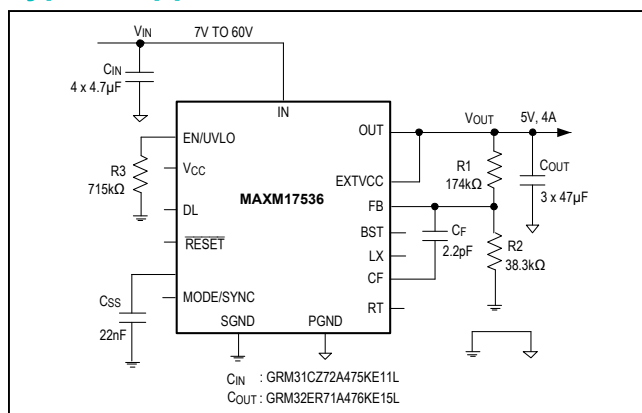

Benefits and Features

- Reduces Design Complexity, Manufacturing Risks, and Time-to-Market
 - Integrated Synchronous Step-Down DC-DC Converter
 - Integrated Inductor
 - Integrated FETs
 - Integrated Compensation Components
- Saves Board Space in Space-Constrained Applications
 - Complete Integrated Step-Down Power Supply in a Single Package
 - Small Profile, 9mm x 15mm x 4.32mm SiP Package
 - Simplified PCB Design with Minimal External BOM Components
- Offers Flexibility for Power-Design Optimization
 - Wide Input-Voltage Range from 4.5V to 60V
 - Output-Voltage Adjustable Range from 0.9V to 12V
 - Adjustable Frequency with External Frequency Synchronization (100kHz to 2.2MHz)
 - PWM, PFM, or DCM Current-Mode Control
 - Programmable Soft-Start
 - Auxiliary Bootstrap LDO for Improved Efficiency
 - Optional Programmable EN/UVLO
- Operates Reliably in Adverse Environments
 - Integrated Thermal Protection
 - Hiccup Mode Overload Protection
 - $\overline{\text{RESET}}$ Output-Voltage Monitoring
 - Ambient Operating Temperature Range (-40°C to +125°C)/Junction Temperature Range (-40°C to +150°C)
 - Complies with CISPR22(EN55022) Class B Conducted and Radiated Emissions

Ordering Information appears at end of data sheet.

Absolute Maximum Ratings

IN to PGND	-0.3V to +65V	EXTVCC to PGND	-0.3V to +26V
EN/UVLO, SS to SGND	-0.3V to +65V	OUT to PGND ($V_{IN} \leq 16V$).....	-0.3V to ($V_{IN} + 0.3V$)
LX to PGND.....	-0.3V to ($V_{IN} + 0.3V$)	OUT to PGND ($V_{IN} > 16V$).....	-0.3V to 16V
BST to PGND	-0.3V to +70V	Output Short-Circuit Duration	Continuous
BST to LX	-0.3V to +6.5V	Operating Temperature Range	-40°C to +125°C
BST to V_{CC}	-0.3V to +65V	Junction Temperature (Note 1).....	+150°C
FB, CF, \overline{RESET} , MODE/SYNC, RT to SGND	-0.3V to +6.5V	Storage Temperature Range	-55°C to +150°C
DL, V_{CC} to PGND	-0.3V to +6.5V	Soldering Temperature (reflow).....	+240°C
SGND to PGND.....	-0.3V to +0.3V		

Stresses beyond those listed under "Absolute Maximum Ratings" may cause permanent damage to the device. These are stress ratings only, and functional operation of the device at these or any other conditions beyond those indicated in the operational sections of the specifications is not implied. Exposure to absolute maximum rating conditions for extended periods may affect device reliability.

Package Information

PACKAGE TYPE: 29-PIN SiP

Package Code	L29915#1
Outline Number	21-100177
Land Pattern Number	90-100055
Thermal Resistance, Four-Layer Board: (Note 2)	
Junction to Ambient (θ_{JA})	24°C/W

For the latest package outline information and land patterns (footprints), go to www.maximintegrated.com/packages. Note that a "+", "#", or "-" in the package code indicates RoHS status only. Package drawings may show a different suffix character, but the drawing pertains to the package regardless of RoHS status.

- Note 1:** Junction temperature greater than +125°C degrades operating lifetimes.
- Note 2:** Package thermal resistance is measured on an evaluation board with natural convection.

Electrical Characteristics

($V_{IN} = V_{EN/UVLO} = 24V$, $R_{RT} = OPEN$ (450kHz), $V_{PGND} = V_{SGND} = V_{MODE/SYNC} = 0V$, $LX = SS = \overline{RESET} = CF = DL = V_{CC} = OUT = open$, $V_{EXTVCC} = 0V$, V_{BST} to $V_{LX} = 5V$, $V_{FB} = 1V$, $T_A = -40^\circ C$ to $+125^\circ C$, unless otherwise noted. Typical values are at $T_A = +25^\circ C$. All voltages are referenced to SGND, unless otherwise noted.) (Note 3)

PARAMETER	SYMBOL	CONDITIONS	MIN	TYP	MAX	UNITS
INPUT SUPPLY (V_{IN})						
Input-Voltage Range	V_{IN}		4.5		60	V
Input-Shutdown Current	I_{IN_SH}	$V_{EN/UVLO} = 0V$, (Shutdown mode)		11	16	μA
Input-Quiescent Current	I_{Q_PFM}	MODE/SYNC = open		128		μA
	I_{Q_DCM}	DCM Mode		1.27	2	mA
	I_{Q_PWM}	PWM Mode, no load, $V_{OUT} = V_{EXTVCC} = 5V$		19		
ENABLE/UNDERVOLTAGE LOCKOUT (EN/UVLO)						
EN/UVLO Threshold	V_{ENR}	$V_{EN/UVLO}$ rising	1.185	1.215	1.245	V
	V_{ENF}	$V_{EN/UVLO}$ falling	1.06	1.09	1.12	
Enable Pullup Resistor	R_{ENP}	Pullup resistor between IN and EN/UVLO pins	3.15	3.32	3.45	M Ω

Electrical Characteristics (continued)

($V_{IN} = V_{EN/UVLO} = 24V$, $R_{RT} = OPEN$ (450kHz), $V_{PGND} = V_{SGND} = V_{MODE/SYNC} = 0V$, $LX = SS = \overline{RESET} = CF = DL = V_{CC} = OUT = open$, $V_{EXTVCC} = 0V$, V_{BST} to $V_{LX} = 5V$, $V_{FB} = 1V$, $T_A = -40^{\circ}C$ to $+125^{\circ}C$, unless otherwise noted. Typical values are at $T_A = +25^{\circ}C$. All voltages are referenced to SGND, unless otherwise noted.) (Note 3)

PARAMETER	SYMBOL	CONDITIONS	MIN	TYP	MAX	UNITS
LOW DROPOUT (INLDO)						
V _{CC} Output Voltage Range	V _{CC}	6V < V _{IN} < 60V, I _{VCC} = 1mA	4.75	5	5.25	V
		1mA < I _{VCC} < 45mA	4.75	5	5.25	
V _{CC} Current Limit	I _{VCC_MAX}	V _{CC} = 4.3V, V _{IN} = 7V	50	90	150	mA
IN to V _{CC} Dropout	V _{CC_DO}	V _{IN} = 4.5V, I _{VCC} = 45mA			0.4	V
V _{CC} UVLO	V _{CC_UVR}	V _{CC} rising	4.1	4.2	4.3	V
	V _{CC_UVF}	V _{CC} falling	3.7	3.8	3.9	
LOW DROPOUT (EXTVCC)						
EXTVCC Operating Voltage Range			4.84		24	V
EXTVCC Switchover Voltage		Rising	4.56	4.7	4.84	V
		Falling	4.33	4.45	4.6	
EXTVCC to V _{CC} Dropout	V _{EXTVCC_DO}	V _{EXTVCC} = 5V, I _{EXTVCC} = 45mA			0.6	V
EXTVCC Current Limit	I _{EXTVCC_MAX}	V _{CC} = 4.3V, EXTVCC = 8V	45	85	140	mA
SOFT-START (SS)						
Charging Current	I _{SS}	V _{SS} = 0.5V	4.7	5	5.3	μA
OUTPUT SPECIFICATIONS						
Line Regulation Accuracy		V _{IN} = 7V to 60V, V _{OUT} = 5V		0.16		mV/V
Load Regulation Accuracy		Tested with I _{OUT} = 0A to 4A at V _{OUT} = 5V		1		mV/A
FB Regulation Voltage	V _{FB_REG}	MODE/SYNC = SGND or MODE = V _{CC}	0.8875	0.9	0.9135	V
		MODE/SYNC = OPEN	0.8875	0.915	0.936	
FB Input Bias Current	I _{FB}	0 < V _{FB} < 1V	-75		+75	nA
FB Undervoltage Trip Level to Cause Hiccup	V _{FB_HICF}		0.55	0.58	0.61	V
HICCUP Timeout				32768		Cycles
MODE/SYNC PIN						
MODE Threshold	V _{M_DCM}	MODE/SYNC = V _{CC} (DCM mode)	V _{CC} - 0.6			V
	V _{M_PFM}	MODE/SYNC = OPEN (PFM mode)	V _{CC} /2			
	V _{M_PWM}	MODE/SYNC = GND (PWM mode)	0.6			
SYNC Frequency-Capture Range		f _{SW} set by R _{RT}	1.1 x f _{SW}	1.4 x f _{SW}		kHz
SYNC Pulse Width			50			ns
SYNC Threshold	V _{IH}		2.0			V
	V _{IL}		0.8			

Electrical Characteristics (continued)

($V_{IN} = V_{EN/UVLO} = 24V$, $R_{RT} = OPEN$ (450kHz), $V_{PGND} = V_{SGND} = V_{MODE/SYNC} = 0V$, $LX = SS = \overline{RESET} = CF = DL = V_{CC} = OUT = open$, $V_{EXTVCC} = 0V$, V_{BST} to $V_{LX} = 5V$, $V_{FB} = 1V$, $T_A = -40^\circ C$ to $+125^\circ C$, unless otherwise noted. Typical values are at $T_A = +25^\circ C$. All voltages are referenced to SGND, unless otherwise noted.) (Note 3)

PARAMETER	SYMBOL	CONDITIONS	MIN	TYP	MAX	UNITS
RT PIN						
Switching Frequency Accuracy		$f_{SW} = 100kHz$ to $2.2MHz$	-12		+12	%
Switching Frequency	f_{SW}	$R_{RT} = open$	420	450	480	kHz
Switching Frequency Adjustable Range			100		2200	kHz
Minimum On-Time	$t_{ON(MIN)}$			114	160	ns
RESET PIN						
\overline{RESET} Sink Current	$I_{\overline{RESET}}$				10	mA
\overline{RESET} Output-Level Low		$I_{\overline{RESET}} = 10mA$			400	mV
\overline{RESET} Output-Leakage Current		$V_{\overline{RESET}} = 5.5V$	-100		+100	nA
V_{OUT} Threshold for \overline{RESET} Assertion	V_{OUT_OKF}	V_{FB} falling	90.4	92.5	94.6	%
V_{OUT} Threshold for \overline{RESET} Deassertion	V_{OUT_OKR}	V_{FB} rising	93.4	95.5	97.7	%
\overline{RESET} Deassertion Delay After FB Reaches 95% Regulation				1024		Cycles
THERMAL SHUTDOWN						
Thermal Shutdown Threshold		Temperature Rising		165		$^\circ C$
Thermal Shutdown Hysteresis				10		$^\circ C$

Note 3: Electrical specifications are production tested at $T_A = +25^\circ C$. Specifications over the entire operating temperature range are guaranteed by design and characterization.

Typical Operating Characteristics

($V_{IN} = V_{EN}/UVLO = 24V$, $V_{SGND} = V_{PGND} = 0V$, $T_A = -40^{\circ}C$ to $+125^{\circ}C$, unless otherwise noted. Typical values are at $T_A = +25^{\circ}C$. All voltages are referenced to GND, unless otherwise noted. The circuit values for different output-voltage applications are as in [Table 1](#), unless otherwise noted.)

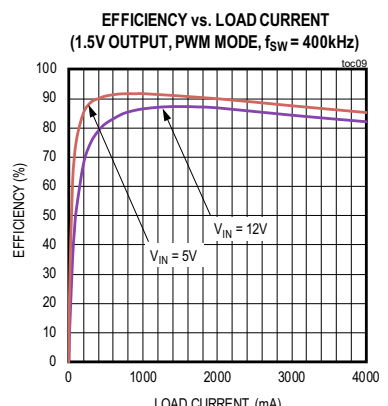
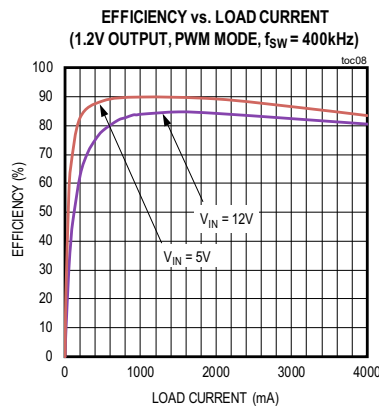
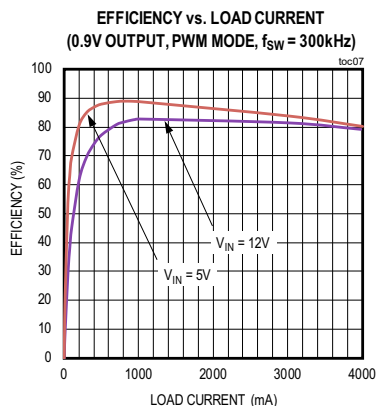
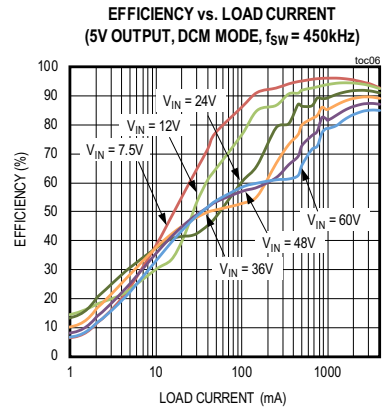
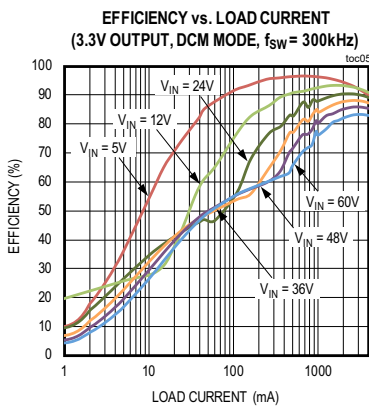
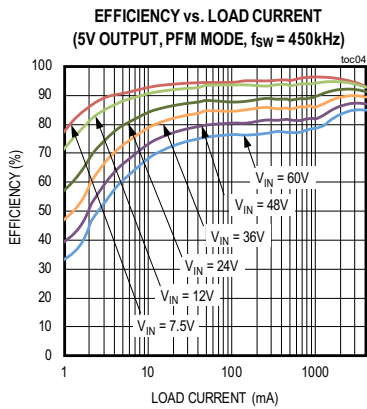
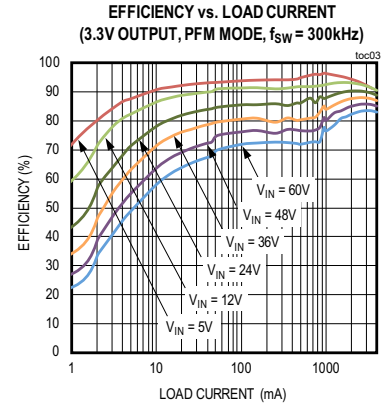
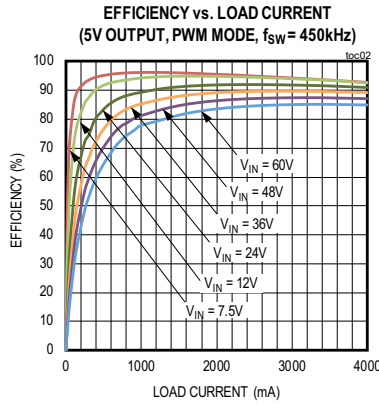
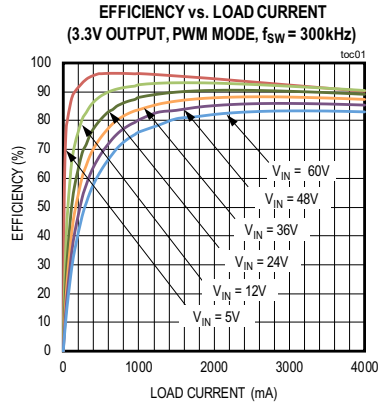

Typical Operating Characteristics (continued)

($V_{IN} = V_{EN}/UVLO = 24V$, $V_{SGND} = V_{PGND} = 0V$, $T_A = -40^{\circ}C$ to $+125^{\circ}C$, unless otherwise noted. Typical values are at $T_A = +25^{\circ}C$. All voltages are referenced to GND, unless otherwise noted. The circuit values for different output-voltage applications are as in [Table 1](#), unless otherwise noted.)

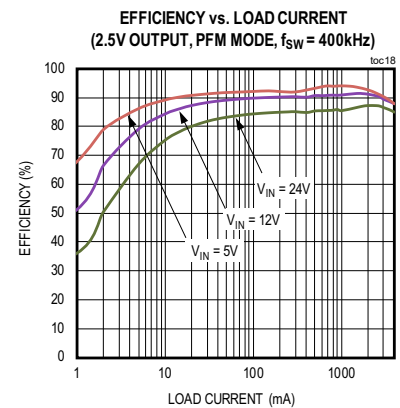
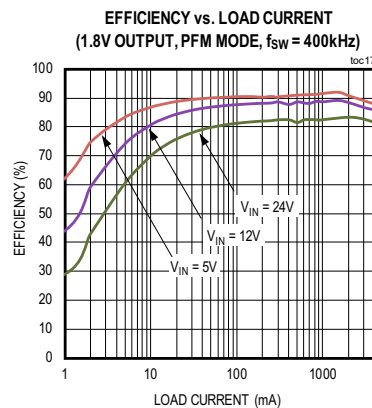
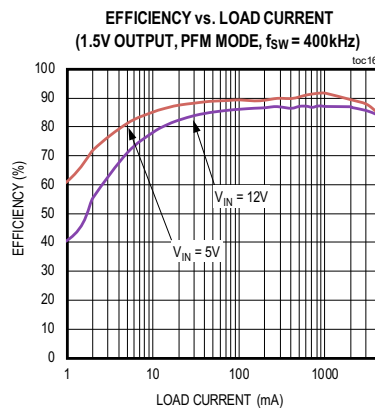
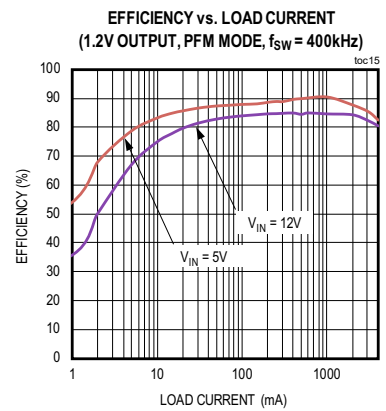
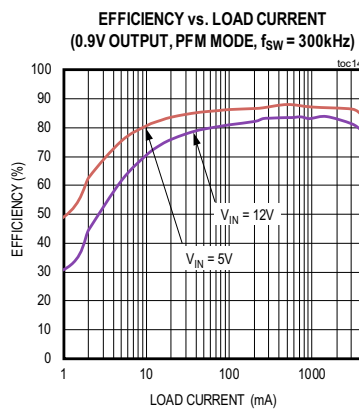
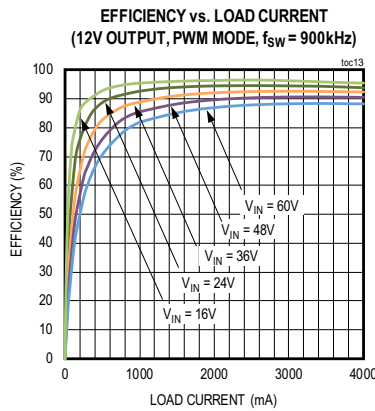
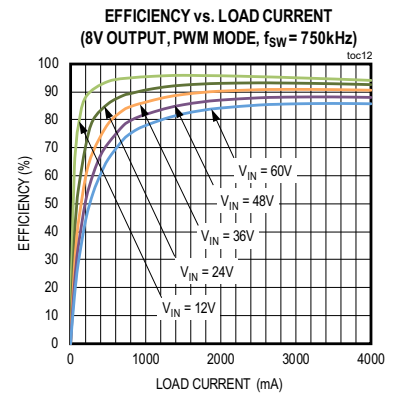
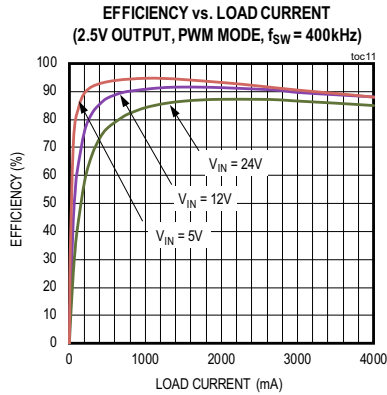
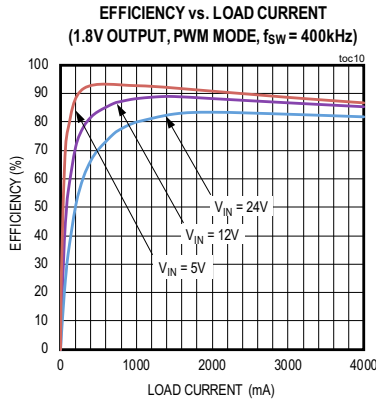

Typical Operating Characteristics (continued)

($V_{IN} = V_{EN}/UVLO = 24V$, $V_{SGND} = V_{PGND} = 0V$, $T_A = -40^{\circ}C$ to $+125^{\circ}C$, unless otherwise noted. Typical values are at $T_A = +25^{\circ}C$. All voltages are referenced to GND, unless otherwise noted. The circuit values for different output-voltage applications are as in [Table 1](#), unless otherwise noted.)

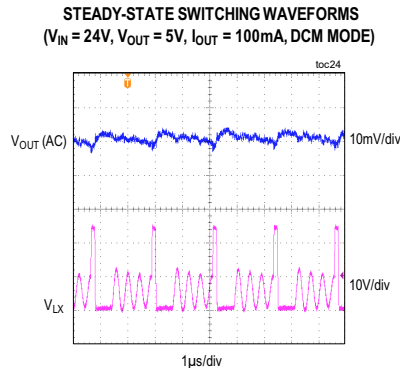
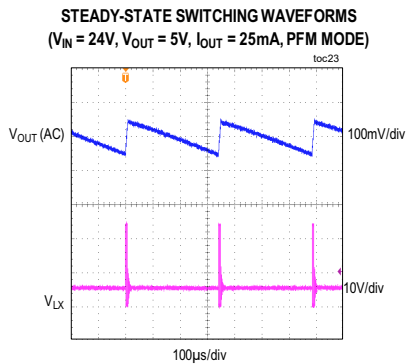
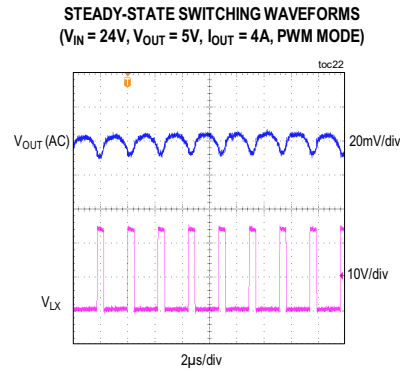
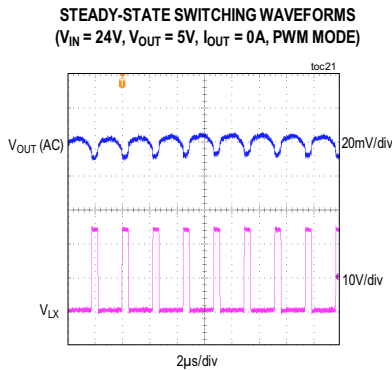
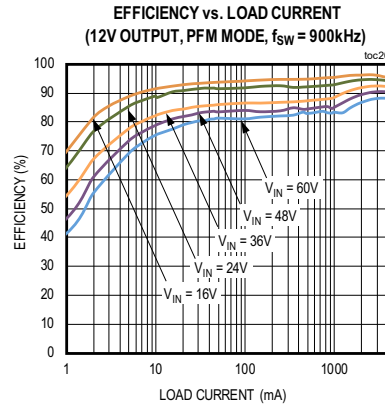
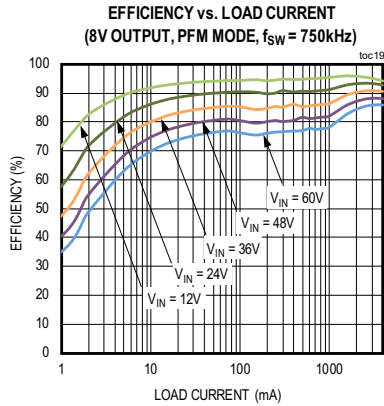

Typical Operating Characteristics (continued)

($V_{IN} = V_{EN/UVLO} = 24V$, $V_{SGND} = V_{PGND} = 0V$, $T_A = -40^{\circ}C$ to $+125^{\circ}C$, unless otherwise noted. Typical values are at $T_A = +25^{\circ}C$. All voltages are referenced to GND, unless otherwise noted. The circuit values for different output-voltage applications are as in [Table 1](#), unless otherwise noted.)

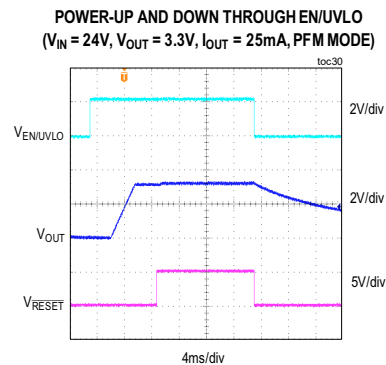
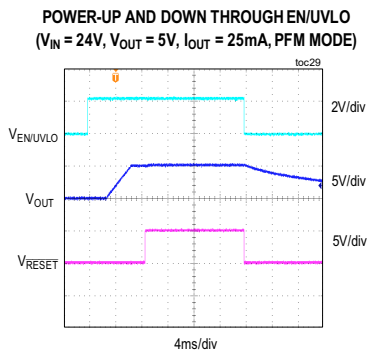
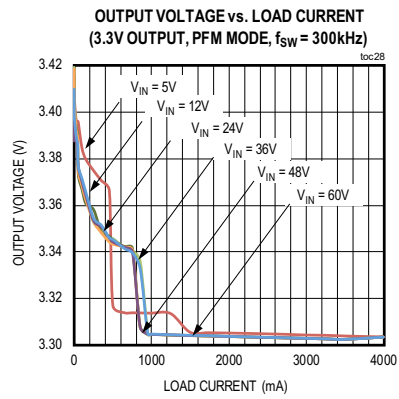
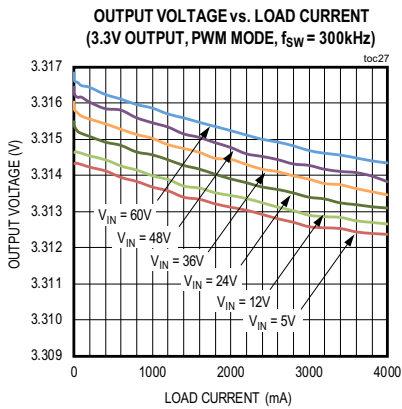
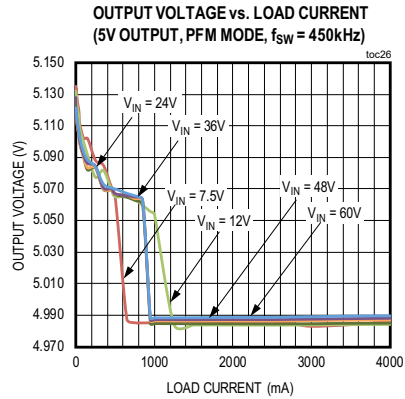
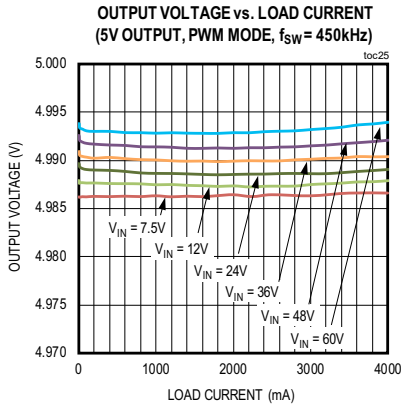

Typical Operating Characteristics (continued)

($V_{IN} = V_{EN/UVLO} = 24V$, $V_{SGND} = V_{PGND} = 0V$, $T_A = -40^{\circ}C$ to $+125^{\circ}C$, unless otherwise noted. Typical values are at $T_A = +25^{\circ}C$. All voltages are referenced to GND, unless otherwise noted. The circuit values for different output-voltage applications are as in [Table 1](#), unless otherwise noted.)

POWER-UP AND DOWN THROUGH EN/UVLO
($V_{IN} = 24V$, $V_{OUT} = 5V$, $I_{OUT} = 4A$, PWM MODE)

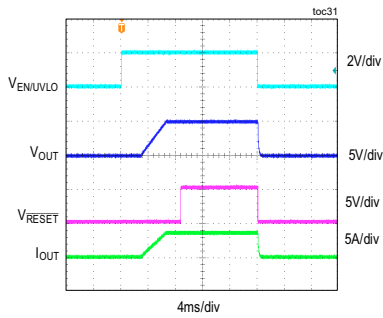

POWER-UP AND DOWN THROUGH EN/UVLO
($V_{IN} = 24V$, $V_{OUT} = 3.3V$, $I_{OUT} = 4A$, PWM MODE)

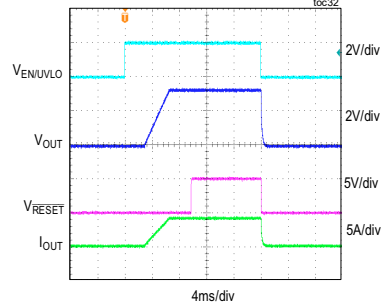

POWER-UP WITH 2.5V BIAS
($V_{IN} = 24V$, $V_{OUT} = 5V$, $I_{OUT} = 0A$, PWM MODE)

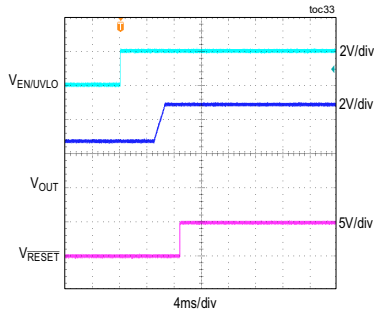

POWER-UP WITH 2.5V BIAS
($V_{IN} = 24V$, $V_{OUT} = 3.3V$, $I_{OUT} = 0A$, PWM MODE)

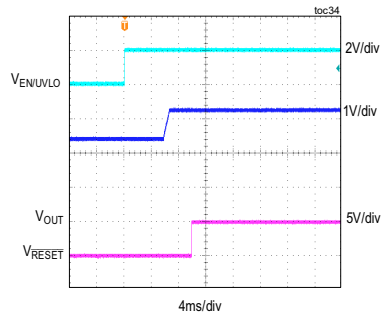

LOAD TRANSIENT
($V_{IN} = 24V$, $V_{OUT} = 5V$, $I_{OUT} = 0A$ TO $2A$, PWM MODE)

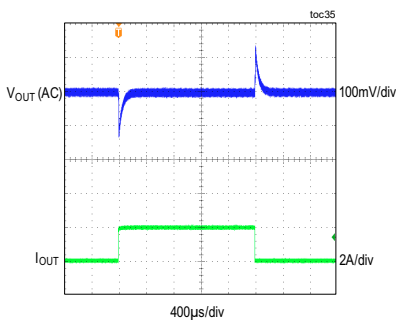

LOAD TRANSIENT
($V_{IN} = 24V$, $V_{OUT} = 5V$, $I_{OUT} = 2A$ TO $4A$, PWM MODE)

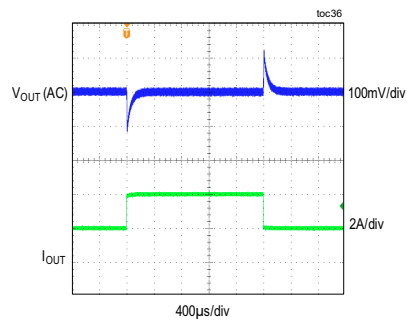

Typical Operating Characteristics (continued)

($V_{IN} = V_{EN/UVLO} = 24V$, $V_{SGND} = V_{PGND} = 0V$, $T_A = -40^{\circ}C$ to $+125^{\circ}C$, unless otherwise noted. Typical values are at $T_A = +25^{\circ}C$. All voltages are referenced to GND, unless otherwise noted. The circuit values for different output-voltage applications are as in [Table 1](#), unless otherwise noted.)

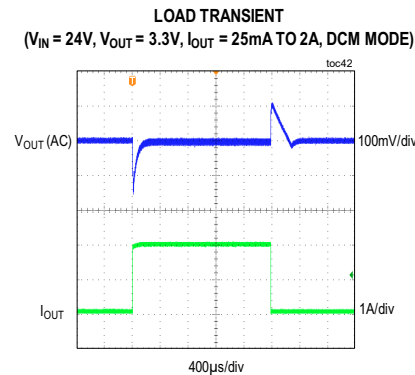
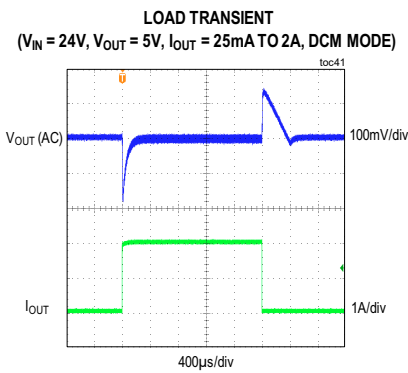
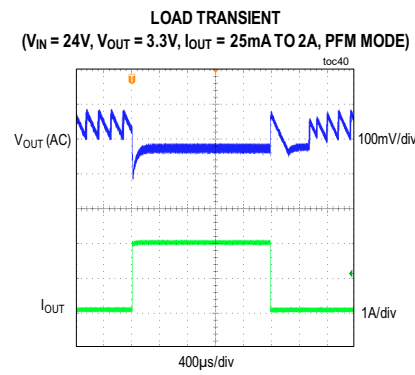
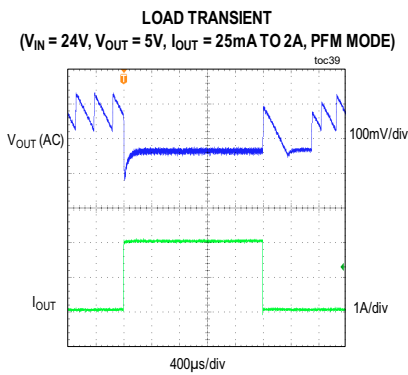
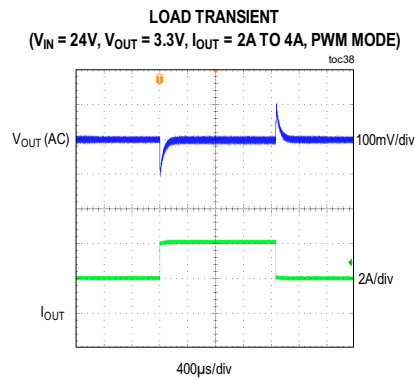
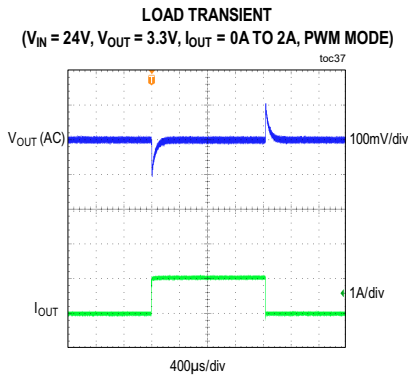

Typical Operating Characteristics (continued)

($V_{IN} = V_{EN/UVLO} = 24V$, $V_{SGND} = V_{PGND} = 0V$, $T_A = -40^{\circ}C$ to $+125^{\circ}C$, unless otherwise noted. Typical values are at $T_A = +25^{\circ}C$. All voltages are referenced to GND, unless otherwise noted. The circuit values for different output-voltage applications are as in Table 1, unless otherwise noted.)

OUTPUT SHORT IN STEADY STATE
($V_{IN} = 24V$, $V_{OUT} = 5V$, PWM MODE)

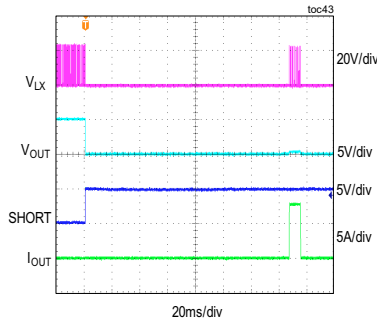

STARTUP INTO SHORT
($V_{IN} = 24V$, $V_{OUT} = 5V$, PWM MODE)

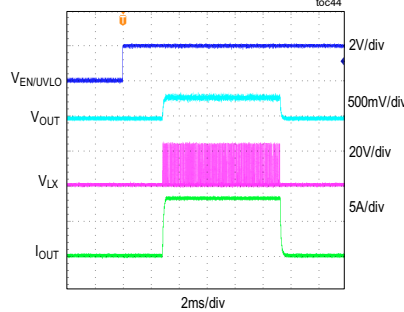

SYNC FREQUENCY AT 630kHz
($V_{IN} = 24V$, $V_{OUT} = 5V$, $I_{OUT} = 4A$, PWM MODE)

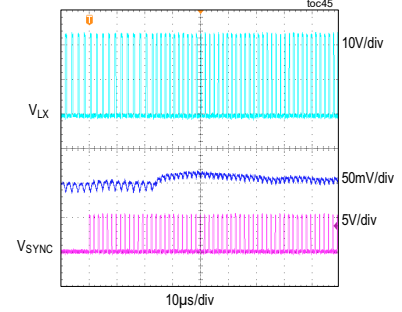

BODE PLOT
($V_{IN} = 24V$, $V_{OUT} = 5V$, $I_{OUT} = 4A$)

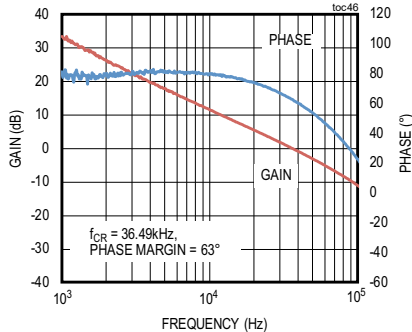

BODE PLOT
($V_{IN} = 24V$, $V_{OUT} = 3.3V$, $I_{OUT} = 4A$)

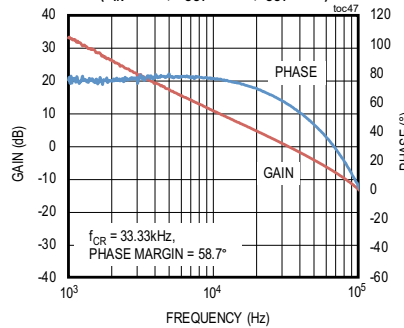

OUTPUT CURRENT vs. AMBIENT TEMPERATURE

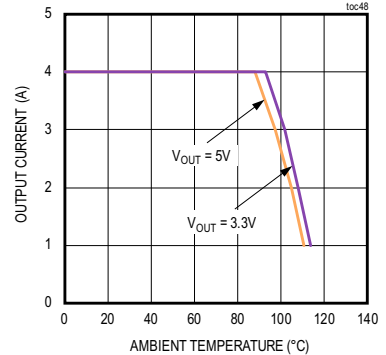

CONDUCTED EMISSION PLOT
(WITH FILTER C18 = C19 = C20 = C21 = C22 = 4.7µF, L1 = 8.2µH)

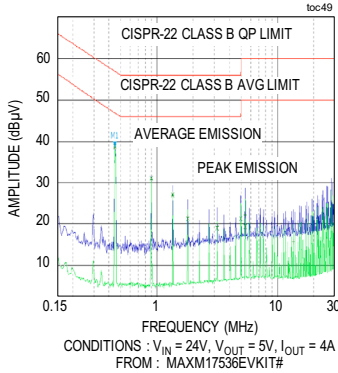

RADIATED EMISSION PLOT
(NO FILTER C18 = C19 = C20 = C21 = C22 = OPEN, L1 = SHORT)

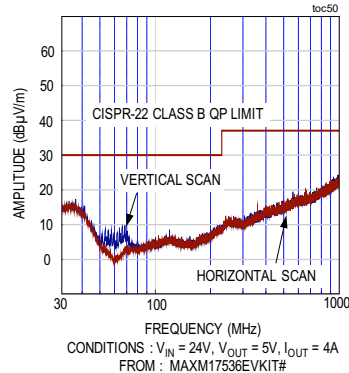

Pin Configuration

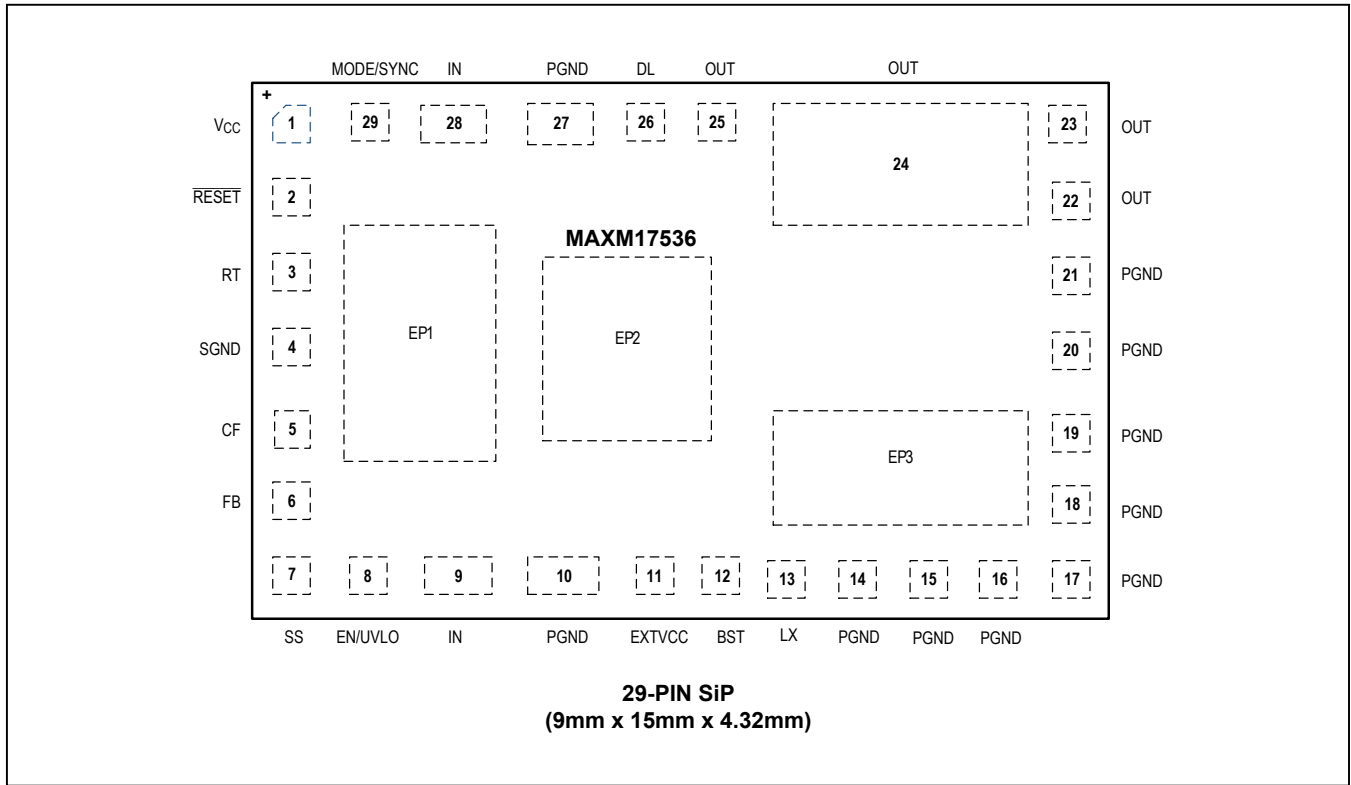

Pin Description

PIN	NAME	FUNCTION
1	V _{CC}	5V LDO Output. The V _{CC} is bypassed to PGND internally through a 2.2μF capacitor. Do not connect any external components to the V _{CC} pin.
2	RESET	Open-Drain RESET Output. The RESET output is driven low if FB drops below 92.5% of its set value. RESET goes high 1024 clock cycles after FB rises above 95.5% of its set value. See the RESET Output section for more details.
3	RT	Switching Frequency Programming. Connect a resistor from RT to SGND to set the regulator's switching frequency. Leave RT open for the default 450kHz frequency. See the Setting the Switching Frequency (RT) section for more details.
4	SGND	Analog Ground.
5	CF	Compensation Pin. Connect a 2.2pF capacitor from CF to FB.
6	FB	Feedback Input. Connect FB to the center tap of an external resistor-divider from the OUT to SGND to set the output voltage.

Pin Description (continued)

PIN	NAME	FUNCTION
7	SS	Soft-Start Input. Connect a capacitor from SS to SGND to set the soft-start time.
8	EN/UVLO	Enable/Undervoltage-Lockout Input. Connect a resistor from EN/UVLO to SGND to set the UVLO threshold. By default, the module is enabled with the EN/UVLO pin open.
9, 28	IN	Power-Supply Input. Decouple to PGND with a capacitor; place the capacitor close to the IN and PGND pins.
10, 14-21, 27	PGND	Power Ground
11	EXTVCC	External Power Supply Input for the Internal LDO. Applying a voltage between 4.7V and 24V at the EXTVCC pin bypasses the internal LDO and improves efficiency.
12	BST	Boost Flying Capacitor Node. Internally a 0.1 μ F is connected from BST to LX. Do not connect any external components to the BST pin.
13	LX	Switching Node. Leave unconnected; do not connect any external components to the LX pin.
22-25	OUT	Regulator Output Pin. Connect a capacitor from OUT to PGND.
26	DL	Gate Drive for Low-Side MOSFET. Do not connect any external components to the DL pin.
29	MODE/ SYNC	MODE Pin Configures the Part to Operate in PWM, PFM, or DCM Modes of Operation. Leave MODE unconnected for PFM operation (pulse skipping at light loads). Connect MODE to SGND for constant frequency PWM operation at all loads. Connect MODE to V _{CC} for DCM operation. The device can be synchronized to an external clock using this pin. See the Mode Selection (MODE) section for more details.
EP1, EP2, EP3	—	Exposed Pad. Create a large copper plane below the module connecting EP1, EP2, and EP3 to improve heat dissipation capability. PGND and SGND are shorted through this plane.

Functional Diagrams

Internal Diagram

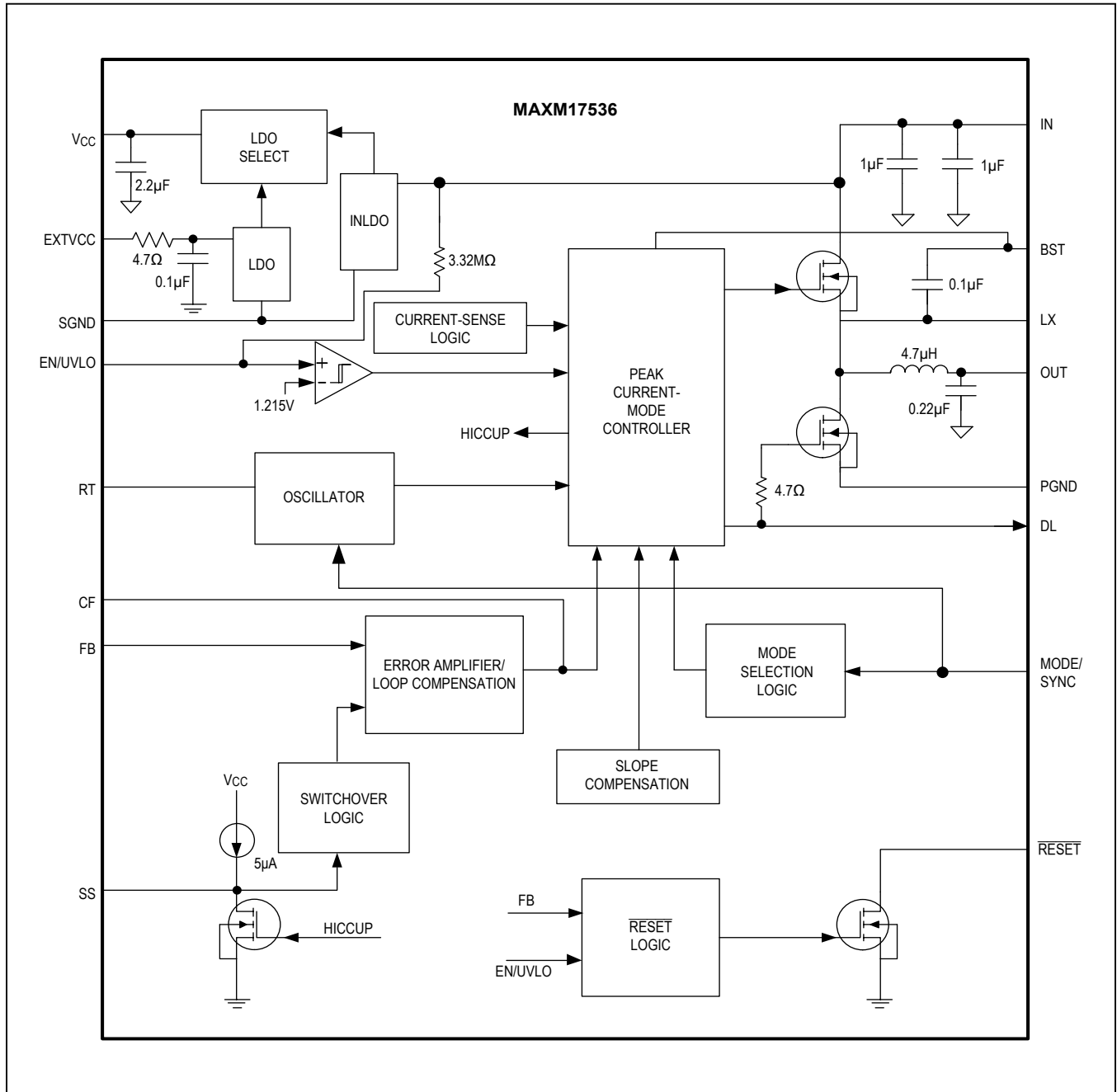

Detailed Description

The MAXM17536 is a high-efficiency, high-voltage, synchronous step-down module with dual-integrated MOSFETs that operates over a 4.5V to 60V input, and supports a programmable output voltage from 0.9V to 12V, delivering up to 4A current. Built-in compensation for the entire output-voltage range eliminates the need for external components. The feedback (FB) regulation accuracy over -40°C to $+125^{\circ}\text{C}$ is $\pm 1.5\%$.

The device features a peak-current-mode control architecture. An internal transconductance-error amplifier produces an integrated error voltage at an internal node that sets the duty cycle using a PWM comparator, a high-side current-sense amplifier, and a slope-compensation generator. At each rising edge of the clock, the high-side MOSFET turns on and remains on until either the appropriate or maximum duty cycle is reached, or the peak current limit is detected. During the high-side MOSFET's on-time, the inductor current ramps up. During the second half of the switching cycle, the high-side MOSFET turns off and the low-side MOSFET turns on. The inductor releases the stored energy as its current ramps down and provides current to the output. The device features a MODE/SYNC pin that can be used to operate the device in PWM, PFM, or DCM control schemes and to synchronize the switching frequency to an external clock. The device integrates adjustable-input undervoltage lockout, adjustable soft-start, open-drain RESET, auxiliary bootstrap LDO, and DL-to-OUT short-detection features.

Mode Selection (MODE)

The logic state of the MODE/SYNC pin is latched when V_{CC} and EN/UVLO voltages exceed the respective UVLO rising thresholds and all internal voltages are ready to allow LX switching. If the MODE/SYNC pin is open at power-up, the device operates in PFM mode at light loads. If the MODE/SYNC pin is grounded at power-up, the device operates in constant-frequency PWM mode at all loads. Finally, if the MODE/SYNC pin is connected to V_{CC} at power-up, the device operates in constant frequency DCM mode at light loads. State changes on the MODE/SYNC pin are ignored during normal operation.

PWM-Mode Operation

In PWM mode, the inductor current is allowed to go negative. PWM operation provides constant frequency operation at all loads, and is useful in applications sensitive to changes in switching frequency. However, the PWM mode of operation gives lower efficiency at light loads compared to PFM and DCM modes of operation.

PFM-Mode Operation

The PFM mode of operation disables negative inductor current and additionally skips pulses at light loads for high efficiency. In PFM mode, the inductor current is forced to a fixed peak of 2A (typ) every clock cycle until the output rises to 102.3% of the nominal voltage. Once the output reaches 102.3% of the nominal voltage, both the high-side and low-side FETs are turned off and the device enters hibernate operation until the load discharges the output to 101.1% of the nominal voltage. Most of the internal blocks are turned off in hibernate operation to minimize quiescent current. After the output falls below 101.1% of the nominal voltage, the device comes out of hibernate operation, turns on all internal blocks, and again commences the process of delivering pulses of energy to the output until it reaches 102.3% of the nominal output voltage. The advantage of the PFM mode is higher efficiency at light loads because of lower quiescent current drawn from the supply. The disadvantage is that the output-voltage ripple is higher compared to PWM or DCM modes of operation and switching frequency is not constant at light loads.

DCM-Mode Operation

DCM mode of operation features constant frequency operation down to lighter loads than PFM mode, by not skipping pulses but only disabling negative inductor current at light loads. DCM operation offers efficiency performance that lies between PWM and PFM modes

Linear Regulator

The MAXM17536 has two internal low-dropout (LDO) regulators that powers V_{CC} . During power-up, when the EN/UVLO pin voltage is above the true shutdown voltage (0.8V), then the V_{CC} is powered from INLDO. When V_{CC} voltage is above the V_{CC} UVLO threshold and EXT V_{CC} voltage is greater than 4.7V (typ) the V_{CC} is powered from EXT V_{CC} LDO. Only one of the two LDOs is in operation at a time depending on the voltage level present at EXT V_{CC} . Powering V_{CC} from EXT V_{CC} increases efficiency at higher input voltages. EXT V_{CC} voltage should not exceed 24V.

Typical V_{CC} output voltage is 5V. Internally V_{CC} is bypassed with a 2.2 μF ceramic capacitor to PGND. See the [Electrical Characteristics](#) table for the current limit details for both the regulators. In applications where the buck converter output is connected to the EXT V_{CC} pin, if the output is shorted to ground, then the transfer from EXT V_{CC} LDO to INLDO happens seamlessly without any impact on the normal functionality.

Setting the Switching Frequency (RT)

The switching frequency of the MAXM17536 can be programmed from 100kHz to 2.2MHz by using a resistor connected from RT to SGND. The switching frequency (f_{SW}) is related to the resistor connected at the RT pin (R_{RT}) by the following equation:

$$R_{RT} \cong \frac{19 \times 10^3}{f_{SW}} - 1.7$$

where R_{RT} is in $k\Omega$ and f_{SW} is in kHz. Leaving the RT pin open causes the device to operate at the default switching frequency of 450kHz. See the [Electrical Characteristics](#) table for RT resistor value recommendations for a few common frequencies.

Operating Input-Voltage Range

The minimum and maximum operating input voltages for a given output voltage should be calculated as follows:

$$V_{IN(MIN)} = \frac{V_{OUT} + (I_{OUT(MAX)} \times 0.076)}{1 - (f_{SW(MAX)} \times 230 \times 10^{-9})} + (I_{OUT(MAX)} \times 0.04)$$

$$V_{IN(MAX)} = \frac{V_{OUT}}{f_{SW(MAX)} \times t_{ON(MIN)}}$$

where,

V_{OUT} = Steady-state output voltage,

$I_{OUT(MAX)}$ = Maximum load current,

$f_{SW(MAX)}$ = Maximum switching frequency,

$t_{ON(MIN)}$ = Worst-case minimum switch on-time (160ns).

Also, for duty cycle > 0.5:

$$V_{IN(MIN)} = (4.04 \times V_{OUT}) - (35 \times 10^{-6} \times f_{SW})$$

where f_{SW} is the switching frequency in Hz.

Choose the greater of the two $V_{IN(MIN)}$ values obtained from the above equations as the minimum operating input voltage.

The [Component Selection Table, Table 1](#) provides the operating input-voltage range and the optimum switching-frequency range for the different selected output voltages.

External Frequency Synchronization (SYNC)

The internal oscillator of the MAXM17536 can be synchronized to an external clock signal on the MODE/SYNC pin. The external synchronization clock frequency must be between $1.1 \times f_{SW}$ and $1.4 \times f_{SW}$, where f_{SW} is the frequency programmed by the RT resistor. When an external clock is applied to the MODE/SYNC pin, the internal oscillator frequency changes to the external clock frequency (from the original frequency based on the RT setting) after detecting 16 external clock edges. The converter operates in PWM mode during synchronization operation. When the external clock is applied to the MODE/SYNC pin, the mode of operation changes to PWM from the initial state of PFM/DCM. When the external clock is removed on-the-fly then the internal oscillator frequency changes to the RT set frequency and the converter still continues to operate in PWM mode. The minimum external clock pulse-width high should be greater than 50ns. See the MODE/SYNC section in the [Electrical Characteristics](#) table for details.

DL-to-OUT Short Detection

In the MAXM17536, DL and OUT pins are adjacent to each other. To prevent damage to the low-side FET in case the DL pin is shorted to the OUT pins, the DL-to-OUT short detection feature has been implemented. If the MAXM17536 detects that the DL pin is shorted to the OUT pins before startup, the startup sequence is not initiated and output voltage is not soft-started.

Overcurrent Protection

The MAXM17536 is provided with a robust overcurrent protection (OCP) scheme that protects the modules under overload and output short-circuit conditions. A cycle-by-cycle peak current limit turns off the high-side MOSFET whenever the high-side switch current exceeds an internal limit of 7.8A (typ). The module enters hiccup mode of operation, either if one occurrence of the runaway current limit 8.8A (typ), or if the FB node goes below 64.5% of its nominal regulation threshold after soft-start is complete. In hiccup mode, the module is protected by suspending switching for a hiccup timeout period of 32,768 switching cycles. Once the hiccup timeout period expires, soft-start is attempted again. Hiccup mode of operation ensures low power dissipation under output overload or short-circuit conditions. Note that when soft-start is attempted under overload condition, if feedback voltage does not exceed 64.5% of desired output voltage, the device switches at half the programmed switching frequency.

The MAXM17536 is designed to support a maximum load current of 4A. The inductor ripple current is calculated as follows:

$$\Delta I = \left(\frac{V_{IN} - V_{OUT} - 0.071 \times I_{OUT}}{L \times f_{SW}} \right) \times \left(\frac{V_{OUT} + 0.051 \times I_{OUT}}{V_{IN} - 0.02 \times I_{OUT}} \right)$$

where:

V_{OUT} = Steady-state output voltage

V_{IN} = Operating input voltage

f_{SW} = Switching frequency

L = Power module output inductance (4.7 μ H \pm 20%)

I_{OUT} = Required output (load) current

The following condition should be satisfied at the desired load current, I_{OUT} :

$$I_{OUT} + \frac{\Delta I}{2} < 7.15$$

RESET Output

The MAXM17536 includes a comparator to monitor the output voltage. The open-drain $\overline{\text{RESET}}$ output requires an external pullup resistor. $\overline{\text{RESET}}$ goes high (high impedance) 1024 switching cycles after the regulator output increases above 95.5% of the designed nominal regulated voltage. $\overline{\text{RESET}}$ goes low when the regulator output voltage drops to below 92.5% of the nominal regulated voltage. $\overline{\text{RESET}}$ also goes low during thermal shutdown.

Prebiased Output

When the MAXM17536 starts into a prebiased output, both the high-side and the low-side switches are turned off so that the converter does not sink current from the output. High-side and low-side switches do not start switching until the PWM comparator commands the first PWM pulse, at which point switching commences. The output voltage is then smoothly ramped up to the target value in alignment with the internal reference.

Thermal-Shutdown Protection

Thermal shutdown protection limits total power dissipation in the MAXM17536. When the junction temperature of the device exceeds +165°C (typ), an on-chip thermal sensor shuts down the device, allowing the device to cool. The thermal sensor turns the device on again after the junction temperature cools by 10°C. Soft-start resets during thermal shutdown. Carefully evaluate the total power dissipation (see the [Power Dissipation](#) section) to avoid unwanted triggering of the thermal shutdown in normal operation.

Applications Information

Input-Capacitor Selection

The input-filter capacitor reduces peak currents drawn from the power source and reduces noise and voltage ripple on the input caused by the circuit's switching. The input capacitor RMS current requirement (I_{RMS}) is defined by the following equation:

$$I_{RMS} = I_{OUT(MAX)} \times \frac{\sqrt{V_{OUT} \times (V_{IN} - V_{OUT})}}{V_{IN}}$$

where, $I_{OUT(MAX)}$ is the maximum load current. I_{RMS} has a maximum value when the input voltage equals twice the output voltage ($V_{IN} = 2 \times V_{OUT}$), so $I_{RMS(MAX)} = I_{OUT(MAX)}/2$. Choose an input capacitor that exhibits less than a +10°C temperature rise at the RMS input current for optimal long-term reliability. Use low-ESR ceramic capacitors with high ripple-current capability at the input. X7R capacitors are recommended in industrial applications for their temperature stability. The C_{IN} capacitor values in [Table 1](#) are the minimum recommended values for the associated operating conditions.

In applications where the source is located distant from the MAXM17536 input, an electrolytic capacitor should be added in parallel to the ceramic capacitor to provide necessary damping for potential oscillations caused by the inductance of the longer input power path and input ceramic capacitor.

Output-Capacitor Selection

X7R ceramic output capacitors are preferred due to their stability over temperature in industrial applications. The output capacitors are usually sized to support a step load of 50% of the maximum output current in the application, so the output-voltage deviation is contained to 3% of the output-voltage change. The minimum required output capacitance can be calculated as follows:

$$C_{OUT} = \frac{1}{2} \times \frac{I_{STEP} \times t_{RESPONSE}}{\Delta V_{OUT}}$$

$$t_{RESPONSE} \cong \left(\frac{0.33}{f_C} + \frac{1}{f_{SW}} \right)$$

where:

I_{STEP} = Load-current step,

$t_{RESPONSE}$ = Response time of the controller,

V_{OUT} = Allowable output-voltage deviation,

f_C = Target closed-loop crossover frequency,

f_{SW} = Switching frequency. Select f_C to be 1/10th of f_{SW} if the switching frequency is less than or equal to 400kHz. Select f_C to be 40kHz if the switching frequency is more than 400kHz.

Soft-Start Capacitor Selection

The MAXM17536 implements adjustable soft-start operation to reduce inrush current. A capacitor connected from the SS pin to SGND programs the soft-start time. The selected output capacitance (C_{SEL}) and the output voltage (V_{OUT}) determine the minimum required soft-start capacitor as follows:

$$C_{SS} \geq 28 \times 10^{-6} \times C_{SEL} \times V_{OUT}$$

The soft-start time (t_{SS}) is related to the capacitor connected at SS (C_{SS}) by the following equation:

$$t_{SS} = \frac{C_{SS}}{5.55}$$

where t_{SS} is in milliseconds and C_{SS} is in nanofarads. For example, to program a 4ms soft-start time, a 22nF capacitor should be connected from the SS pin to SGND.

Setting the Input Undervoltage-Lockout Level

The MAXM17536 offers an adjustable input undervoltage lockout level. Set the voltage at which MAXM17536 turns on. Calculate R3 as follows:

$$R3 = \frac{3.32 \times 1.215}{(V_{INU} - 1.215)}$$

where R3 is in M Ω and V_{INU} is the voltage at which the MAXM17536 is required to turn on. Ensure that V_{INU} is higher than 0.8 x V_{OUT} .

Loop Compensation

The MAXM17536 is internally loop-compensated. Connect a 2.2pF capacitor from CF to FB for stable operation.

Typically, designs with crossover frequency (f_C) less than $f_{SW}/10$ and less than 40kHz offers good phase margin and transient response. For other choices of f_C , the design should be carefully evaluated according to user requirements.

Adjusting Output Voltage

Set the output voltage with a resistive voltage-divider connected from the positive terminal of the output capacitor (V_{OUT}) to SGND (see [Figure 2](#)). Connect the center node of the divider to the FB pin. To choose the resistive voltage-divider values calculate for resistor R1, then R2.

First, calculate resistor R1 from the output to FB as follows:

$$R1 = \frac{451 \times 10^3}{f_C \times C_{OUT}}$$

where:

R1 is in k Ω

f_C = Desired crossover frequency (kHz)

C_{OUT} = Derated value of the capacitor (μ F)

Then, calculate resistor R2 from FB to SGND as follows:

$$R2 = \frac{R1 \times 0.9}{(V_{OUT} - 0.9)}$$

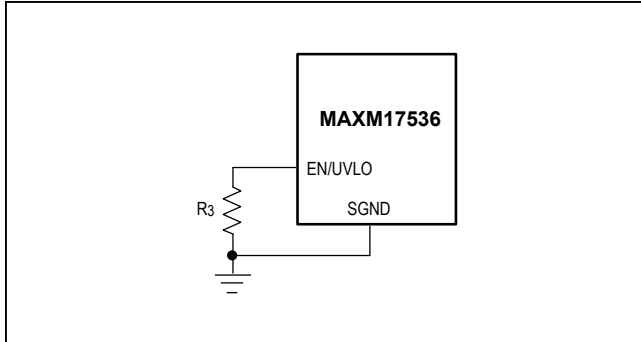

Figure 1. Setting the Input-Undervoltage Lockout

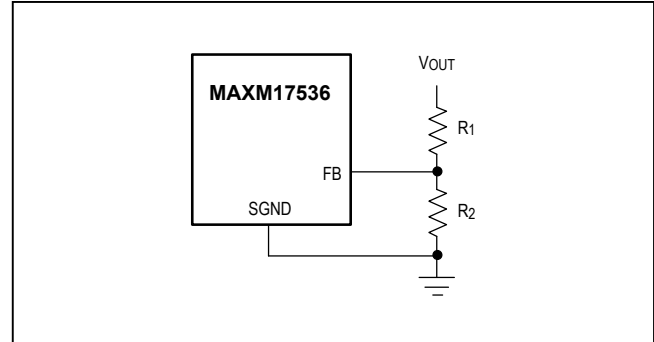

Figure 2. Setting the Output Voltage

Component Selection Table

Table 1. Selection Component Values

V _{IN} (V)	V _{OUT} (V)	C _{IN}	C _{OUT}	R ₁ (kΩ)	R ₂ (kΩ)	f _{SW} (kHz)	R _{RT} (kΩ)
4.5 to 16	0.9	4 x 4.7μF, 1206, X7R, 50V	12 x 47μF, 1210, X7R, 10V	33.2	Open	300	61.9
4.5 to 17	1.2	4 x 4.7μF, 1206, X7R, 50V	9 x 47μF, 1210, X7R, 10V	39.2	118	400	45.3
4.5 to 21	1.5	4 x 4.7μF, 1206, X7R, 50V	7 x 47μF, 1210, X7R, 10V	52.3	78.7	400	45.3
4.5 to 26	1.8	4 x 4.7μF, 1206, X7R, 50V	5 x 47μF, 1210, X7R, 10V	71.5	71.5	400	45.3
4.5 to 35	2.5	4 x 4.7μF, 1206, X7R, 50V	5 x 47μF, 1210, X7R, 10V	57.6	32.4	400	45.3
4.5 to 60	3.3	4 x 4.7μF, 1206, X7R, 100V	4 x 47μF, 1210, X7R, 10V	121	45.3	300	61.9
7 to 60	5	4 x 4.7μF, 1206, X7R, 100V	3 x 22μF, 1210, X7R, 25V	174	38.3	450	Open
11 to 60	8	4 x 4.7μF, 1206, X7R, 100V	3 x 22μF, 1210, X7R, 25V	294	37.4	750	24
16 to 60	12	4 x 4.7μF, 1206, X7R, 100V	3 x 22μF, 1210, X7R, 25V	340	27.4	900	19.6

Power Dissipation

The power dissipation inside the module leads to increase in the junction temperature of the MAXM17536. The power loss inside the module at full load can be estimated as follows:

$$P_{LOSS} = P_{OUT} \left(\frac{1}{\eta} - 1 \right) - \frac{P_{OUT}^2}{1000 \times V_{OUT}} \times (1 + 0.0043 \times T_A) \times \left(\frac{45.15}{V_{OUT}} - \frac{21.67}{V_{IN}} \right)$$

where:

P_{OUT} = Total output power

V_{OUT} = Output voltage

V_{IN} = Input voltage

η is the efficiency of the power module at the desired operating conditions. See the [Typical Operating Characteristics](#) for the power-conversion efficiency or measure the efficiency to determine the total power dissipation. The junction temperature (T_J) of the module can be estimated at any given maximum ambient temperature (T_A) from the following equation:

$$T_J = T_A + (\theta_{JA} \times P_{LOSS})$$

For the MAXM17536 evaluation board, the thermal resistance from junction-to-ambient (θ_{JA}) is 24°C/W. Operating the module at junction temperatures greater than +125°C degrades operating lifetimes. An EE-SIM model is available for the MAXM17536 to simulate efficiency and power loss for the desired operating conditions.

PCB Layout Guidelines

- All connections carrying pulsed currents must be very short and as wide as possible. The inductance of these connections must be kept to an absolute minimum due to the high di/dt of the currents. Since inductance of a current carrying loop is proportional to the area enclosed by the loop, if the loop area is made very small, inductance is reduced. Additionally, small current-loop areas reduce radiated EMI.
- A ceramic input-filter capacitor should be placed close to the IN pins of the module. This eliminates as much trace-inductance effects as possible and gives the module a cleaner voltage supply.
- PCB layout also affects the thermal performance of the design. A number of thermal vias that connect to a large ground plane should be provided under the exposed pad of the part, for efficient heat dissipation.
- For a sample layout that ensures first pass success, refer to the MAXM17536 evaluation kit PCB layout available at www.maximintegrated.com.

Typical Application Circuits

Typical Application Circuit for 5V Output

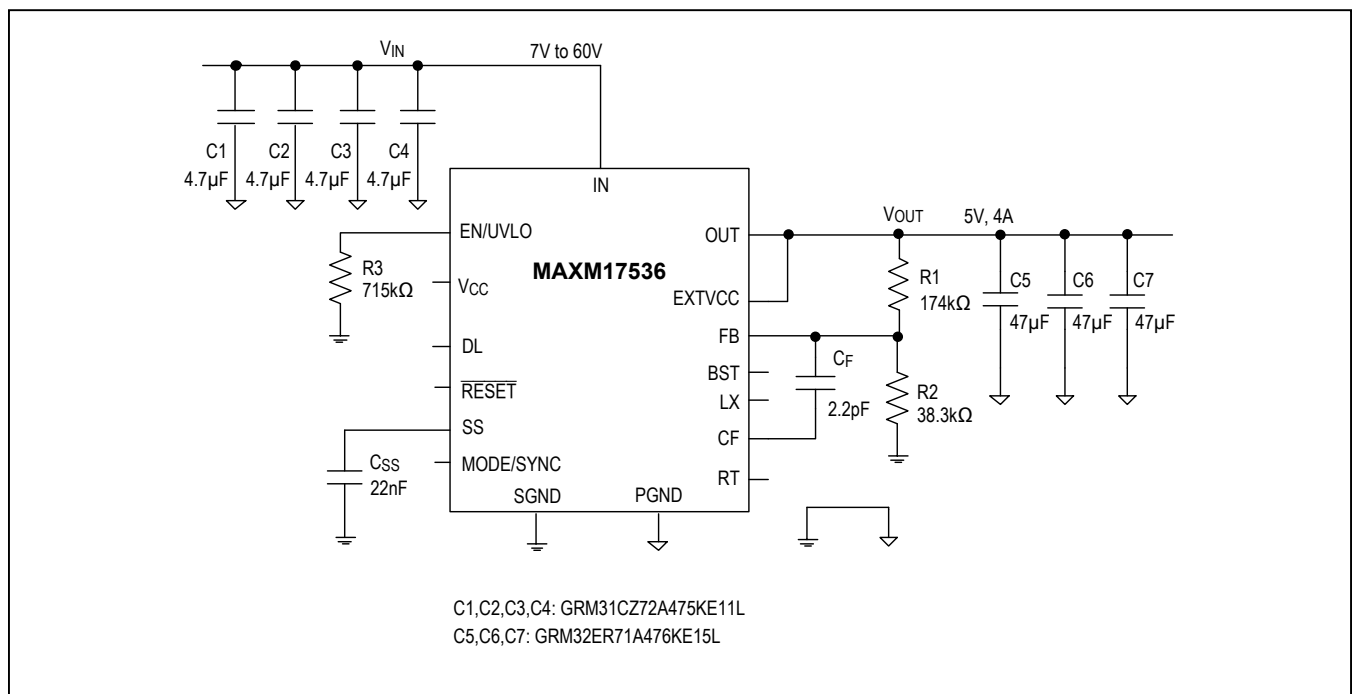

Typical Application Circuits (continued)

Typical Application Circuit 3.3V

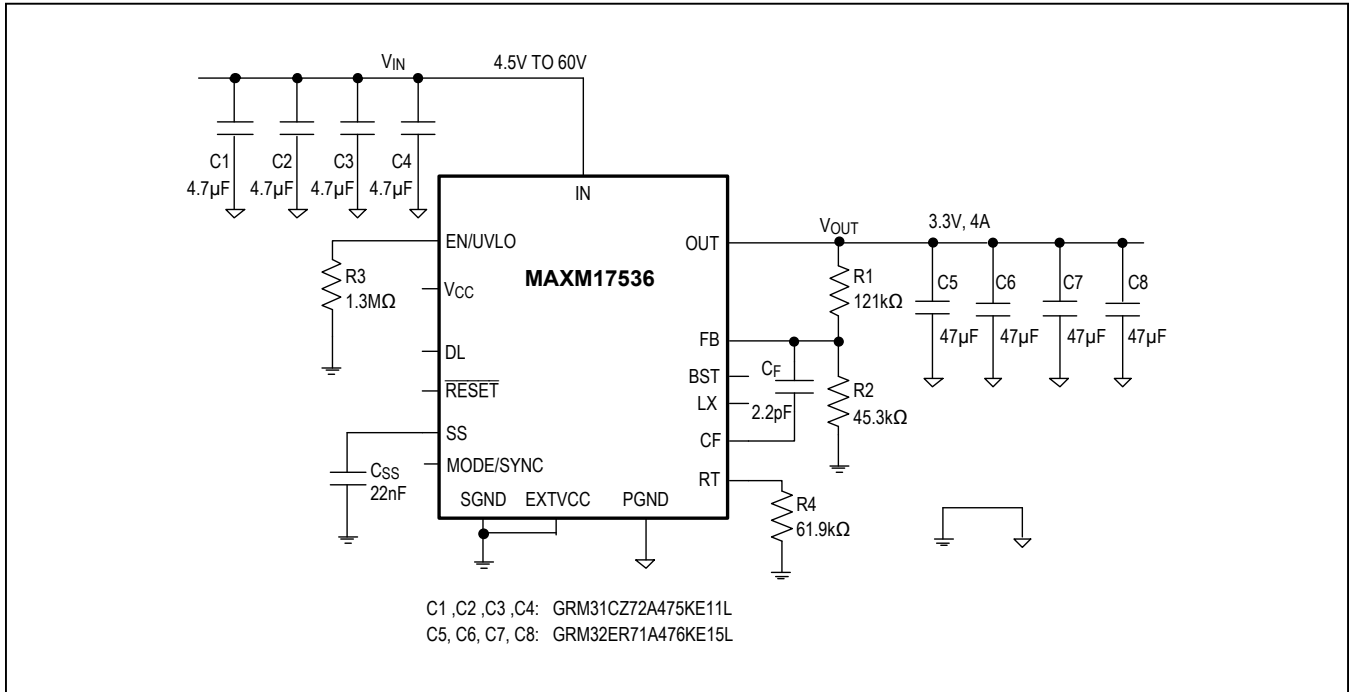

Ordering Information

PART NUMBER	TEMP RANGE	PIN-PACKAGE
MAXM17536ALY#	-40°C to +125°C	29 SiP
MAXM17536ALY#T	-40°C to +125°C	29 SiP

#Denotes a RoHS-compliant device that may include lead(Pb) that is exempt under the RoHS requirements.

T = Tape and reel.

Revision History

REVISION NUMBER	REVISION DATE	DESCRIPTION	PAGES CHANGED
0	6/19	Initial release	—
1	8/19	Updated <i>Typical Application Circuit</i> , <i>Electrical Characteristics</i> , <i>Functional Diagram</i> , <i>Operating Input-Voltage Range</i> , <i>Power Dissipation</i> , and <i>Typical Application Circuit for 3.3V Output</i> sections; replaced TOC47 and <i>Typical Application Circuit for 5V Output</i> ; updated graphics to standard; corrected typos	1-3, 11, 14-17, 19-21

For pricing, delivery, and ordering information, please visit Maxim Integrated's online storefront at <https://www.maximintegrated.com/en/storefront/storefront.html>.

Maxim Integrated cannot assume responsibility for use of any circuitry other than circuitry entirely embodied in a Maxim Integrated product. No circuit patent licenses are implied. Maxim Integrated reserves the right to change the circuitry and specifications without notice at any time. The parametric values (min and max limits) shown in the Electrical Characteristics table are guaranteed. Other parametric values quoted in this data sheet are provided for guidance.