

FEATURES

- High vibration rejection over wide frequency
- Ultrafast startup: 3 ms
- Measurement range extendable to $\pm 50,000^\circ/\text{sec}$
- 10,000 g powered shock survivability
- Ratiometric to referenced supply
- 5 V single-supply operation
- Z-axis (yaw rate) response
- -40°C to $+105^\circ\text{C}$ operation
- Self-test on digital command
- Ultrasmall and light ($<0.15\text{ cc}$, $<0.5\text{ gram}$)
- Temperature sensor output
- RoHS compliant

APPLICATIONS

- Sports equipment
- Industrial applications
- Platform stabilization
- High speed tachometry

GENERAL DESCRIPTION

The ADXRS649 is a complete angular rate sensor (gyroscope) that uses the Analog Devices, Inc., patented high volume BiMOS surface-micromachining process to make a complete gyro on one chip. An advanced, differential, quad sensor design rejects the influence of linear acceleration, enabling the ADXRS649 to offer rate sensing in harsh environments where shock and vibration are present.

The output signal, RATEOUT (B1, A2), is a voltage proportional to the angular rate about the axis normal to the top surface of the package. The output is ratiometric with respect to a provided reference supply. An external capacitor is used to set the bandwidth. The measurement range is extendable to $\pm 50,000^\circ/\text{sec}$ by adding an external resistor.

Low power consumption (3.5 mA) enables very low power consumption, and ultrafast startup (3 ms) allows for quick power cycling of the gyro. At 10 samples per second, a pair of CR2032 coin cells can power the ADXRS649 for three months.

A temperature output is provided for compensation techniques. Two digital self-test inputs electromechanically excite the sensor to test proper operation of both the sensor and the signal conditioning circuits. The ADXRS649 is available in a $7\text{ mm} \times 7\text{ mm} \times 3\text{ mm}$ CBGA chip scale package.

FUNCTIONAL BLOCK DIAGRAM

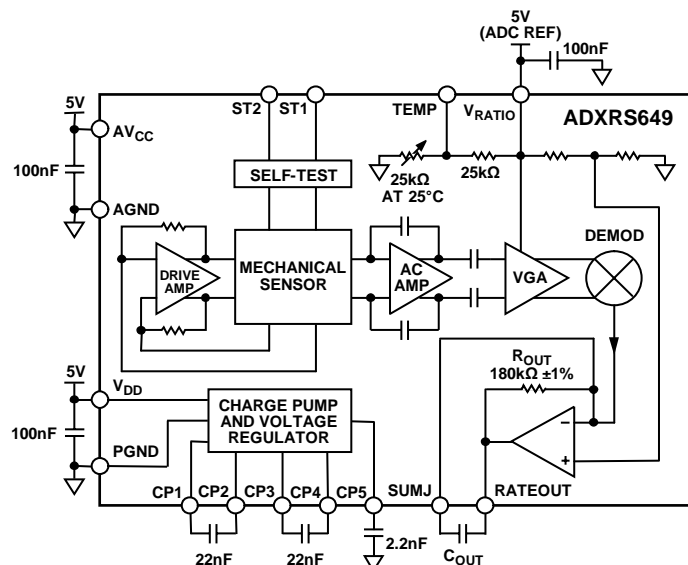

Figure 1.

Rev. B

[Document Feedback](#)

Information furnished by Analog Devices is believed to be accurate and reliable. However, no responsibility is assumed by Analog Devices for its use, nor for any infringements of patents or other rights of third parties that may result from its use. Specifications subject to change without notice. No license is granted by implication or otherwise under any patent or patent rights of Analog Devices. Trademarks and registered trademarks are the property of their respective owners.

One Technology Way, P.O. Box 9106, Norwood, MA 02062-9106, U.S.A.
 Tel: 781.329.4700 ©2010–2012 Analog Devices, Inc. All rights reserved.
[Technical Support](#) www.analog.com

TABLE OF CONTENTS

Features	1	Typical Performance Characteristics	6
Applications.....	1	Theory of Operation	9
General Description	1	Setting the Bandwidth	9
Functional Block Diagram	1	Temperature Output and Calibration.....	10
Revision History	2	Modifying the Measurement Range	10
Specifications.....	3	Null Bias Adjustment.....	10
Absolute Maximum Ratings.....	4	Self-Test Function	10
Rate Sensitive Axis	4	Continuous Self-Test.....	10
ESD Caution.....	4	Outline Dimensions	11
Pin Configuration and Function Descriptions.....	5	Ordering Guide	11

REVISION HISTORY

10/12—Rev. A to Rev. B

Changes to Figure 1.....	1
Changed Sensor Resonant Frequency Minimum Parameter from 16 kHz to 15.5 kHz	1
Changed Sensor Resonant Frequency Typical Parameter from 18 kHz to 17.5 kHz	3

3/11—Rev. 0 to Rev. A

Changes to Ordering Guide	11
---------------------------------	----

12/10—Revision 0: Initial Version

SPECIFICATIONS

All minimum and maximum specifications are guaranteed. Typical specifications are not guaranteed.

$T_A = -40^{\circ}\text{C}$ to $+105^{\circ}\text{C}$, $V_S = AV_{CC} = V_{DD} = V_{RATIO} = 5\text{ V}$, angular rate = $0^{\circ}/\text{sec}$, bandwidth = 80 Hz ($C_{OUT} = 0.01\ \mu\text{F}$), $I_{OUT} = 100\ \mu\text{A}$, $\pm 1\text{ g}$, unless otherwise noted.

Table 1.

Parameter	Test Conditions/Comments	Min	Typ	Max	Unit
SENSITIVITY ¹	Clockwise rotation is positive output				
Measurement Range ²	Full-scale range over specifications range		$\pm 20,000$		$^{\circ}/\text{sec}$
Initial and over Temperature	-40°C to $+105^{\circ}\text{C}$	0.08	0.1	0.12	$\text{mV}/^{\circ}/\text{sec}$
Temperature Drift ³			± 2		%
Nonlinearity	Best fit straight line		0.1		% of FS
NULL BIAS ¹					
Null Bias	-40°C to $+105^{\circ}\text{C}$	2.4	2.5	2.6	V
Linear Acceleration Effect	Any axis		0.1		$^{\circ}/\text{sec}/\text{g}$
Vibration Rectification	40 g rms, 50 Hz to 27 kHz		0.0006		$^{\circ}/\text{sec}/\text{g}^2$
NOISE PERFORMANCE					
Rate Noise Density	$T_A = 25^{\circ}\text{C}$ $T_A = 105^{\circ}\text{C}$		0.25 0.4		$^{\circ}/\text{sec}/\sqrt{\text{Hz}}$ $^{\circ}/\text{sec}/\sqrt{\text{Hz}}$
Resolution Floor	$T_A = 25^{\circ}\text{C}$, 1 minute to 1 hour in-run		200		$^{\circ}/\text{hr}$
FREQUENCY RESPONSE					
Bandwidth ⁴	$\pm 3\text{ dB}$ user adjustable up to specification		2000		Hz
Sensor Resonant Frequency		15.5	17.5	20	kHz
SELF-TEST ¹					
ST1 RATEOUT Response	ST1 pin from Logic 0 to Logic 1		-1300		$^{\circ}/\text{sec}$
ST2 RATEOUT Response	ST2 pin from Logic 0 to Logic 1		1300		$^{\circ}/\text{sec}$
ST1 to ST2 Mismatch ⁵			± 2		%
Logic 1 Input Voltage		3.3			V
Logic 0 Input Voltage				1.7	V
Input Impedance	To common	40	50	100	k Ω
TEMPERATURE SENSOR ¹					
V_{OUT} at 25°C	Load = 10 M Ω	2.3	2.4	2.5	V
Scale Factor ⁶	$T_A = 25^{\circ}\text{C}$, $V_{RATIO} = 5\text{ V}$		9		$\text{mV}/^{\circ}\text{C}$
Load to V_S			25		k Ω
Load to Common			25		k Ω
TURN-ON TIME ⁷	Power on to $\pm 90\%$ of final output, CP5 = 2.2 nF		3		ms
OUTPUT DRIVE CAPABILITY					
Current Drive	For rated specifications			200	μA
Capacitive Load Drive				1000	pF
POWER SUPPLY					
Operating Voltage (V_S)		4.75	5.00	5.25	V
Quiescent Supply Current			3.5		mA
TEMPERATURE RANGE					
Specified Performance		-40		+105	$^{\circ}\text{C}$

¹ Parameter is linearly ratiometric with V_{RATIO} .

² Measurement range is the maximum range possible, including output swing range, initial offset, sensitivity, offset drift, and sensitivity drift at 5 V supplies.

³ From $+25^{\circ}\text{C}$ to -40°C or $+25^{\circ}\text{C}$ to $+105^{\circ}\text{C}$.

⁴ Adjusted by external capacitor, C_{OUT} . Reducing bandwidth below 0.01 Hz does not result in further noise improvement.

⁵ Self-test mismatch is described as $(ST2 + ST1)/((ST2 - ST1)/2)$.

⁶ Scale factor for a change in temperature from 25°C to 26°C . V_{TEMP} is ratiometric to V_{RATIO} . See the Temperature Output and Calibration section for more information.

⁷ Based on characterization.

ABSOLUTE MAXIMUM RATINGS

Table 2.

Parameter	Rating
Acceleration (Any Axis, 0.5 ms)	
Unpowered	10,000 <i>g</i>
Powered	10,000 <i>g</i>
V_{DD}, AV_{CC}	-0.3 V to +6.0 V
V_{RATIO}	AV_{CC}
ST1, ST2	AV_{CC}
Output Short-Circuit Duration (Any Pin to Common)	Indefinite
Operating Temperature Range	-55°C to +125°C
Storage Temperature Range	-65°C to +150°C

Stresses above those listed under the Absolute Maximum Ratings may cause permanent damage to the device. This is a stress rating only; functional operation of the device at these or any other conditions above those indicated in the operational section of this specification is not implied. Exposure to absolute maximum rating conditions for extended periods may affect device reliability.

Drops onto hard surfaces can cause shocks of greater than 10,000 *g* and can exceed the absolute maximum rating of the device. Care should be exercised in handling to avoid damage.

RATE SENSITIVE AXIS

The ADXRS649 is a z-axis rate-sensing device (also called a yaw rate-sensing device). It produces a positive going output voltage for clockwise rotation about the axis normal to the package top, that is, clockwise when looking down at the package lid.

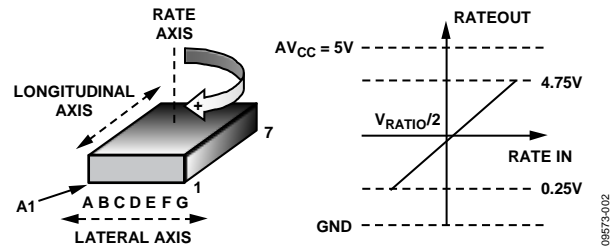

Figure 2. RATEOUT Signal Increases with Clockwise Rotation

ESD CAUTION



ESD (electrostatic discharge) sensitive device. Charged devices and circuit boards can discharge without detection. Although this product features patented or proprietary protection circuitry, damage may occur on devices subjected to high energy ESD. Therefore, proper ESD precautions should be taken to avoid performance degradation or loss of functionality.

PIN CONFIGURATION AND FUNCTION DESCRIPTIONS

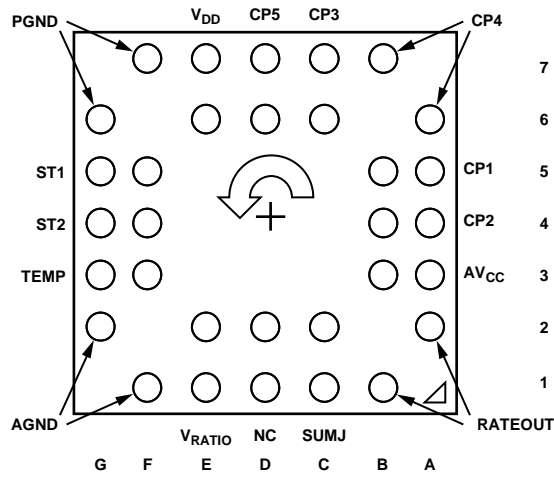

NOTES
 1. NC = NO CONNECT. DO NOT CONNECT TO THIS PIN.

Figure 3. Pin Configuration

09573-003

Table 3. Pin Function Descriptions

Pin No.	Mnemonic	Description
D6, D7	CP5	High Voltage Filter Capacitor, 2.2 nF.
A6, B7	CP4	Charge Pump Capacitor, 22 nF.
C6, C7	CP3	Charge Pump Capacitor, 22 nF.
A5, B5	CP1	Charge Pump Capacitor, 22 nF.
A4, B4	CP2	Charge Pump Capacitor, 22 nF.
A3, B3	AV _{CC}	Positive Analog Supply.
B1, A2	RATEOUT	Rate Signal Output.
C1, C2	SUMJ	Output Amplifier Summing Junction.
D1, D2	NC	Do not connect to these pins.
E1, E2	V _{RATIO}	Reference Supply for Ratiometric Output.
F1, G2	AGND	Analog Supply Return.
F3, G3	TEMP	Temperature Voltage Output.
F4, G4	ST2	Self-Test for Sensor 2.
F5, G5	ST1	Self-Test for Sensor 1.
G6, F7	PGND	Charge Pump Supply Return.
E6, E7	V _{DD}	Positive Charge Pump Supply.

TYPICAL PERFORMANCE CHARACTERISTICS

N > 1000 for all histograms, unless otherwise noted.

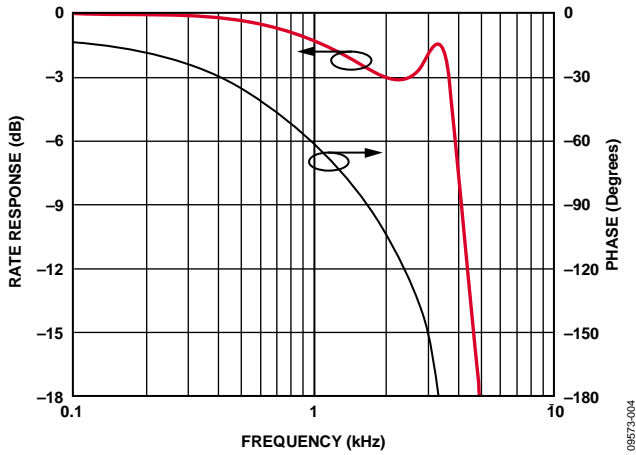

Figure 4. Typical Rate and Phase Response vs. Frequency ($C_{OUT} = 470$ pF with a Series RC Low-Pass Filter of 3.3 k Ω and 22 nF)

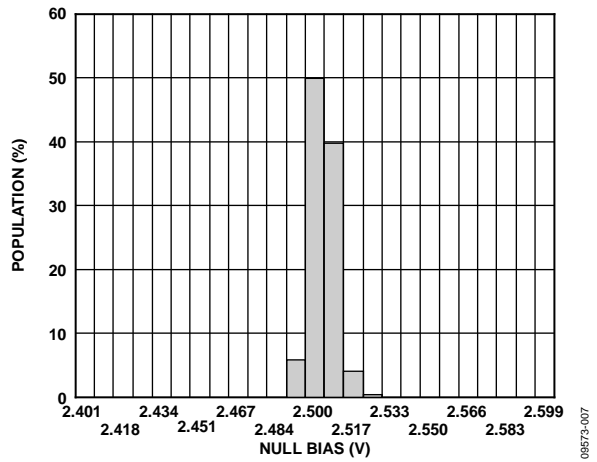

Figure 7. Null Bias at 25°C

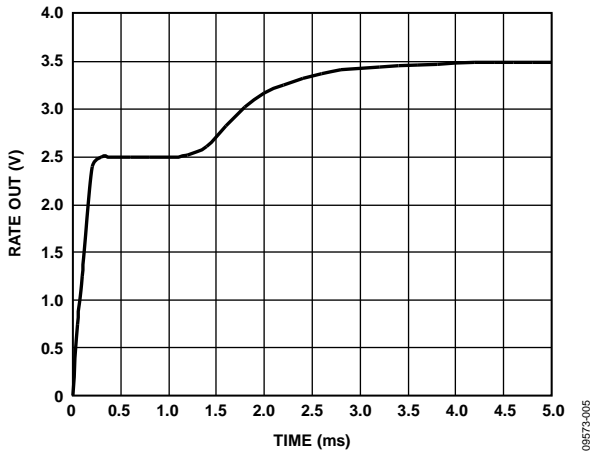

Figure 5. Typical Start-Up Behavior at RATEOUT

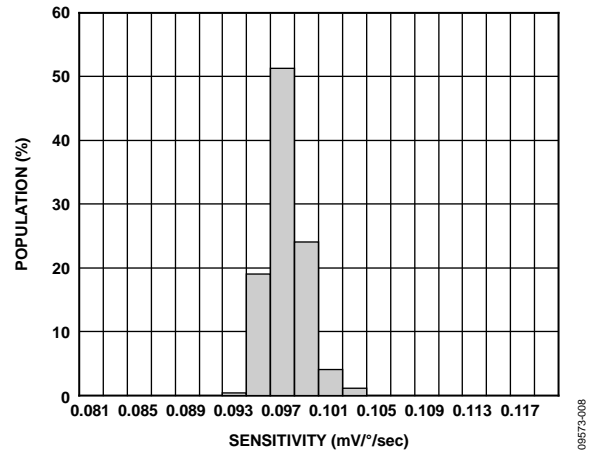

Figure 8. Sensitivity at 25°C

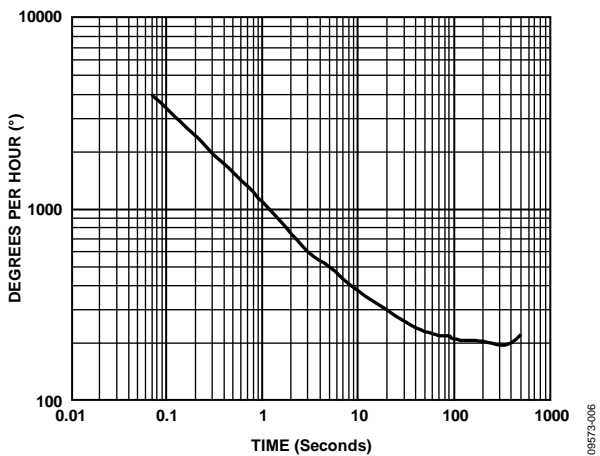

Figure 6. Typical Root Allan Deviation at 25°C vs. Averaging Time

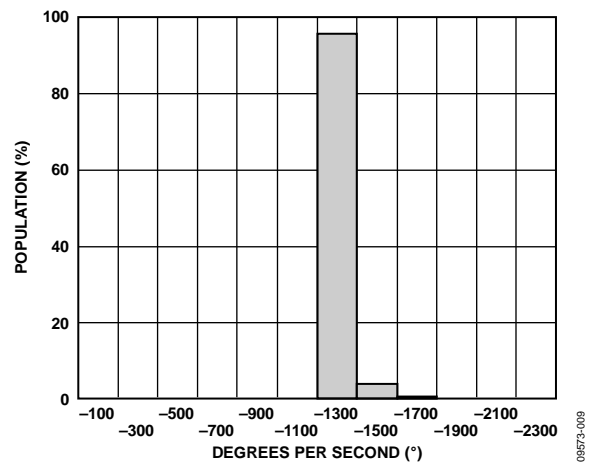

Figure 9. ST1 Output Change at 25°C ($V_{RATIO} = 5$ V)

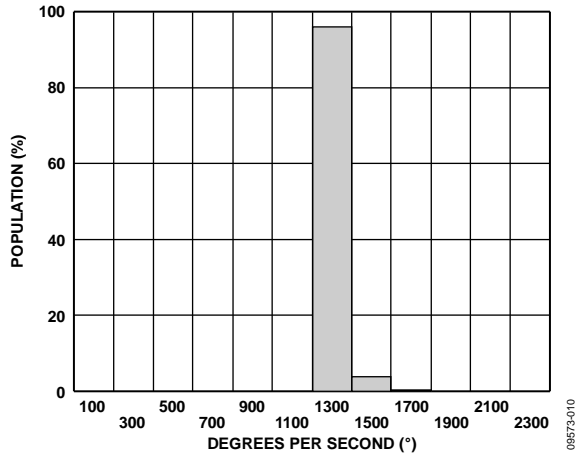

Figure 10. ST2 Output Change at 25°C ($V_{RATIO} = 5 V$)

09573-010

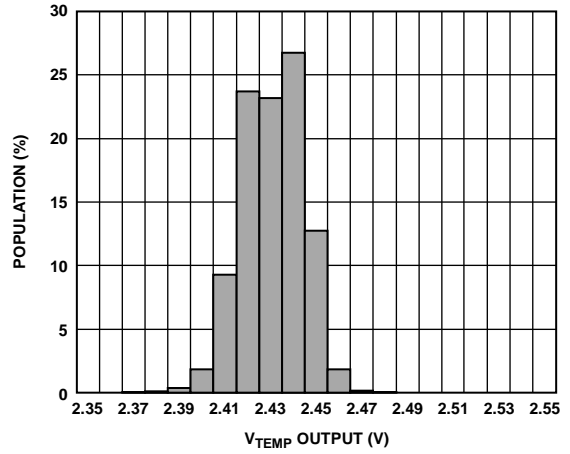

Figure 13. V_{TEMP} Output at 25°C ($V_{RATIO} = 5 V$)

09573-013

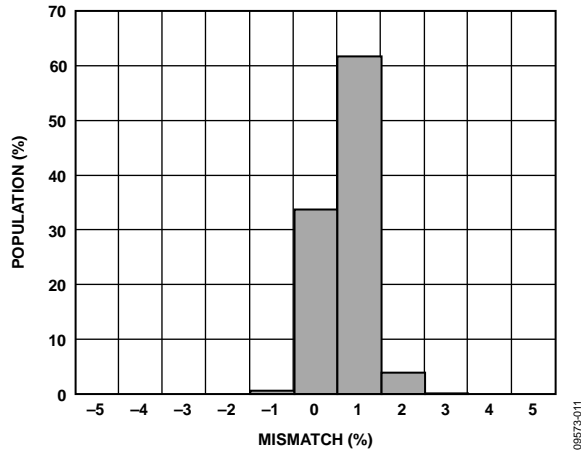

Figure 11. Self-Test Mismatch at 25°C ($V_{RATIO} = 5 V$)

09573-011

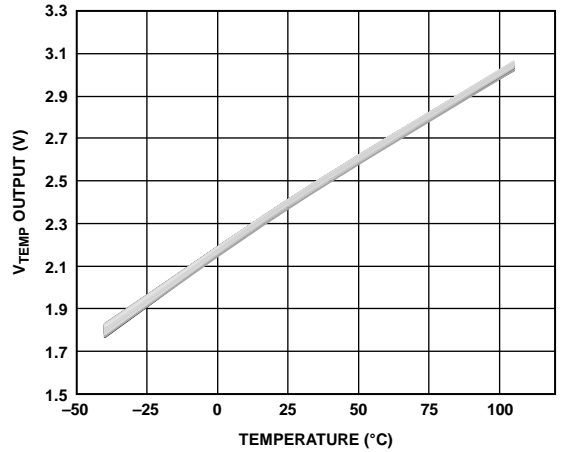

Figure 14. V_{TEMP} Output over Temperature, 256 Parts ($V_{RATIO} = 5 V$)

09573-014

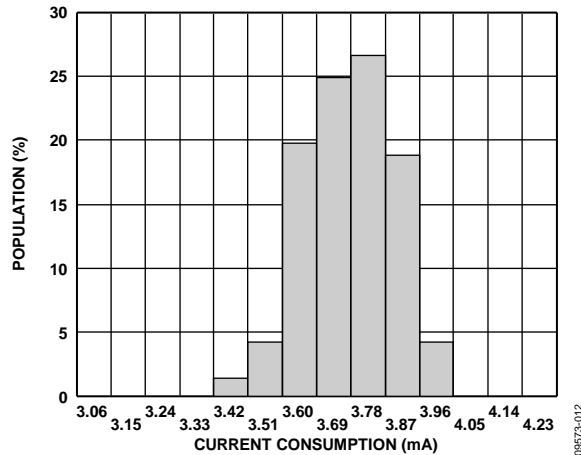

Figure 12. Current Consumption at 25°C ($V_{RATIO} = 5 V$)

09573-012

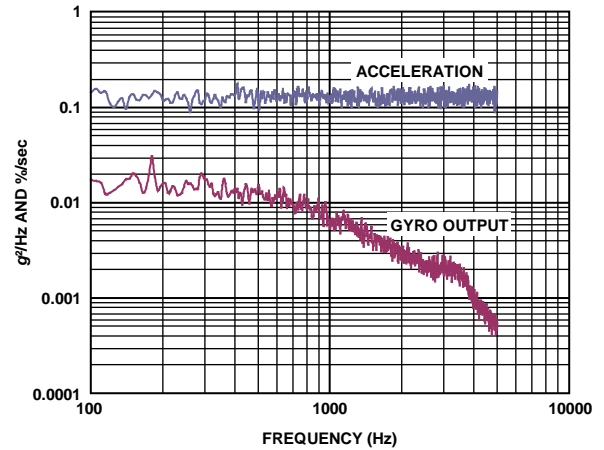

Figure 15. Typical Response to 25 g RMS Random Vibration, 50 Hz to 5 kHz (Sensor Bandwidth = 1 kHz)

09573-015

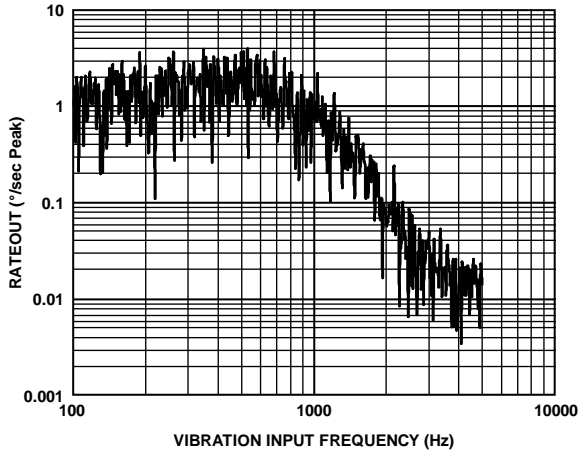

Figure 16. Typical Response to 10 g RMS Sinusoidal Vibration (Sensor Bandwidth = 1 kHz)

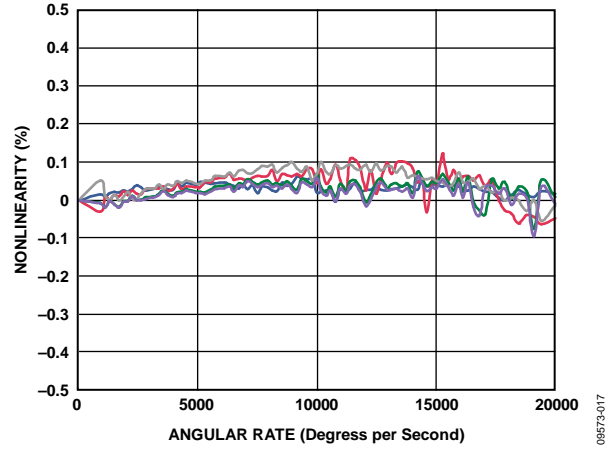

Figure 17. Typical Nonlinearity (Four Typical Devices)

THEORY OF OPERATION

The ADXRS649 operates on the principle of a resonator gyro. Figure 18 shows a simplified version of one of four polysilicon sensing structures. Each sensing structure contains a dither frame that is electrostatically driven to resonance. This produces the necessary velocity element to produce a Coriolis force when experiencing angular rate. The ADXRS649 is designed to sense a z-axis (yaw) angular rate.

When the sensing structure is exposed to angular rate, the resulting Coriolis force couples into an outer sense frame, which contains movable fingers that are placed between fixed pickoff fingers. This forms a capacitive pickoff structure that senses Coriolis motion. The resulting signal is fed to a series of gain and demodulation stages that produce the electrical rate signal output. The quad sensor design rejects linear and angular acceleration, including external g -forces and vibration. This is achieved by mechanically coupling the four sensing structures such that external g -forces appear as common-mode signals that can be removed by the fully differential architecture implemented in the ADXRS649.

The electrostatic resonator requires 13 V to 15 V for operation. Because only 5 V are typically available in most applications, a charge pump is included on chip. If an external 13 V to 15 V supply is available, the two capacitors on CP1 to CP4 can be omitted, and this supply can be connected to CP5 (Pin D6,

Pin D7). CP5 should not be grounded when power is applied to the ADXRS649. No damage occurs, but under certain conditions, the charge pump may fail to start up after the ground is removed without first removing power from the ADXRS649.

SETTING THE BANDWIDTH

External Capacitor C_{OUT} is used in combination with the on-chip R_{OUT} resistor to create a low-pass filter to limit the bandwidth of the ADXRS649 rate response. The -3 dB frequency set by R_{OUT} and C_{OUT} is

$$f_{OUT} = 1/(2 \times \pi \times R_{OUT} \times C_{OUT})$$

f_{OUT} can be well controlled because R_{OUT} has been trimmed during manufacturing to be $180 \text{ k}\Omega \pm 1\%$. Any external resistor applied between the RATEOUT pin (B1, A2) and the SUMJ pin (C1, C2) results in

$$R_{OUT} = (180 \text{ k}\Omega \times R_{EXT}) / (180 \text{ k}\Omega + R_{EXT})$$

In general, an additional filter (in either hardware or software) is added to attenuate high frequency noise arising from demodulation spikes at the 18 kHz resonant frequency of the gyro. An RC output filter consisting of a $3.3 \text{ k}\Omega$ series resistor and 22 nF shunt capacitor (2.2 kHz pole) is recommended.

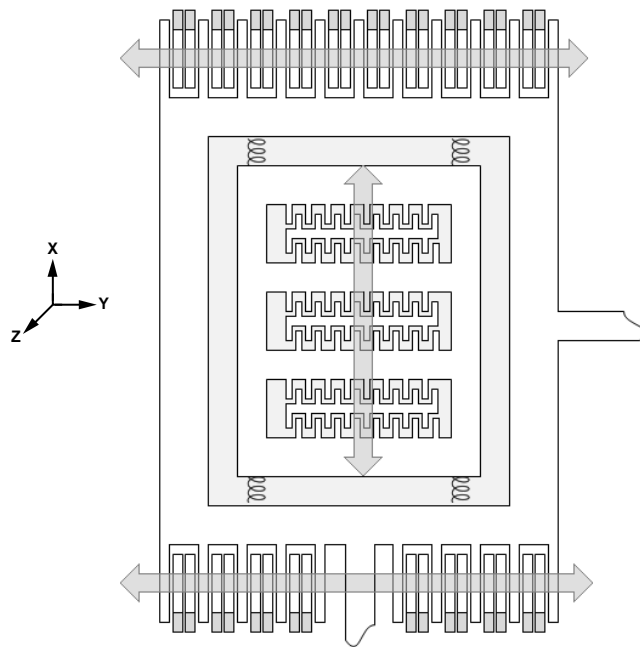

Figure 18. Simplified Gyro Sensing Structure—One Corner

06573-018

TEMPERATURE OUTPUT AND CALIBRATION

It is common practice to temperature-calibrate gyros to improve their overall accuracy. The ADXRS649 has a temperature proportional voltage output that provides input to such a calibration method. The temperature sensor structure is shown in Figure 19. The temperature output is characteristically nonlinear, and any load resistance connected to the TEMP output results in decreasing the TEMP output and its temperature coefficient. Therefore, buffering the output is recommended.

The voltage at TEMP (F3, G3) is nominally 2.5 V at 25°C, and $V_{RATIO} = 5$ V. The temperature coefficient is ~ 9 mV/°C at 25°C. Although the TEMP output is highly repeatable, it has only modest absolute accuracy.

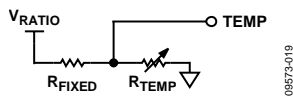

Figure 19. Temperature Sensor Structure

MODIFYING THE MEASUREMENT RANGE

The ADXRS649 scale factor can be reduced to extend the measurement range to as much as $\pm 50,000^\circ/\text{sec}$ by adding a single 120 k Ω resistor between the RATEOUT and SUMJ pins. If an external resistor is added between RATEOUT and SUMJ, C_{OUT} must be proportionally increased to maintain correct bandwidth.

NULL BIAS ADJUSTMENT

The nominal 2.5 V null bias is for a symmetrical swing range at RATEOUT (B1, A2). However, a nonsymmetrical output swing may be suitable in some applications. Null bias adjustment is possible by injecting a suitable current to SUMJ (C1, C2). Note that supply disturbances may reflect some null bias instability. Digital supply noise should be avoided, particularly in this case.

SELF-TEST FUNCTION

The ADXRS649 includes a self-test feature that actuates each of the sensing structures and associated electronics in the same manner, as if subjected to angular rate. The self-test is activated by standard logic high levels applied to Input ST1 (F5, G5), Input ST2 (F4, G4), or both. ST1 causes the voltage at RATEOUT to change by approximately -0.15 V, and ST2 causes an opposite change of $+0.15$ V. The self-test response follows the viscosity temperature dependence of the package atmosphere, approximately $0.25\%/^\circ\text{C}$.

Activating ST1 and ST2 simultaneously does not damage the part. ST1 and ST2 are fairly closely matched ($\pm 2\%$), but actuating both simultaneously may result in a small apparent null bias shift proportional to the degree of self-test mismatch.

ST1 and ST2 are activated by applying a voltage equal to V_{RATIO} to the ST1 pin and the ST2 pin. The voltage applied to ST1 and ST2 must never be greater than AV_{CC} .

CONTINUOUS SELF-TEST

The on-chip integration of the ADXRS649 gives it higher reliability than is obtainable with any other high volume manufacturing method. In addition, it is manufactured under a mature BiMOS process that has field-proven reliability. As an additional failure detection measure, a power-on self-test can be performed. However, some applications may warrant continuous self-test while sensing rate. Information about continuous self-test techniques is also available in the [AN-768](#) Application Note, *Using the ADXRS150/ADXRS300 in Continuous Self-Test Mode*.

OUTLINE DIMENSIONS

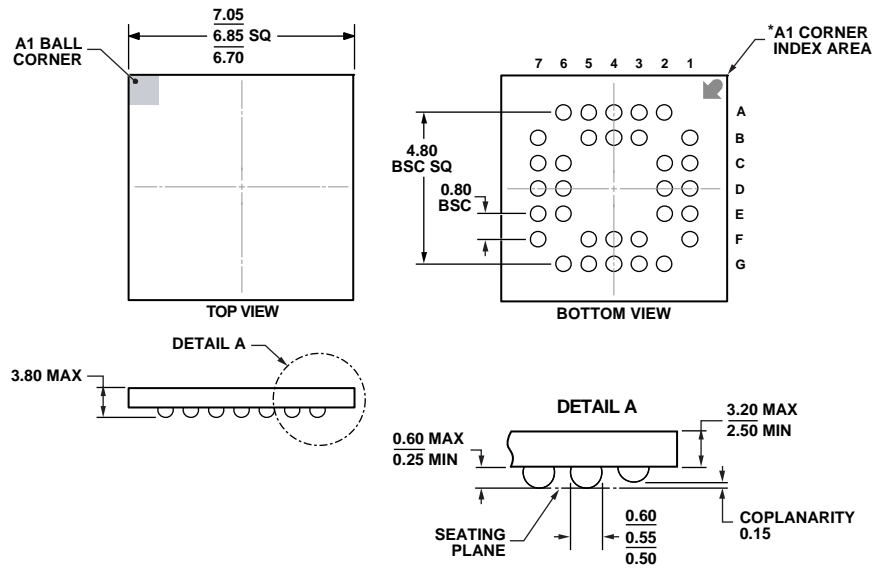

BALL DIAMETER
 *BALL A1 IDENTIFIER IS GOLD PLATED AND CONNECTED TO THE D/A PAD INTERNALLY VIA HOLES.

Figure 20. 32-Lead Ceramic Ball Grid Array [CBGA] (BG-32-3)
 Dimensions shown in millimeters

10-26-2009-B

ORDERING GUIDE

Model ¹	Temperature Range	Package Description	Package Option
ADXRS649BBGZ-RL	-40°C to +105°C	32-Lead Ceramic Ball Grid Array [CBGA]	BG-32-3
ADXRS649BBGZ	-40°C to +105°C	32-Lead Ceramic Ball Grid Array [CBGA]	BG-32-3
EVAL-ADXRS649Z		Evaluation Board	

¹ Z = RoHS Compliant Part.

NOTES