

Data sheet

Art.No.: 46.031.4553.1

Connector RST16i3 S B1 ZT4 SW

RST16i3 connector, 3 pole, female, screw connection, application 250V with PE, 16A, for cable diameters 5.0-9.5mm, coding color black, color of housing black



Art.No.	46.031.4553.1
EAN	4049088280221
Order Unit	1

Certificates / Approvals



Technical data

General

Rated current	16 A
Rated voltage	250 V
Rated impulse voltage	4 kV
strain relief	Yes
Pollution degree	3
Lockable	self-locking (unlocking by hand)
Color of coding/ contact carrier	black
Marking of poles	L, N, PE
Color of housing inclusive strain relief	black

Connection Data

Cable diameter max.	9.5 mm
Cable diameter min.	5 mm
Connection cross section solid mm ² max.	2.5 mm ²
Connection cross section solid mm ² min.	0.25 mm ²
Connection cross section fine stranded mm ² max.	1.5 mm ²
Connection cross section fine stranded mm ² min.	0.25 mm ²
Terminations per pole	1
Connection cross section stranded mm ² min.	0.25 mm ²
Connection cross section stranded mm ² max.	1.5 mm ²
sheath strip length	25 mm
Wire strip length	8 mm

Model

Model	female
Connection type	Screw connection
Degree of protection (IP)	IP66/68 (3m;2h) /IP69

Material

Housing material	Polyamide
halogen free	Yes
Contact material	CuZn
Fire load	0 kWh
Insulation components continuous temperature	100 °C
Surface finish	Silver-plated

Dimensions

Length	71 mm
Width	19.9 mm
Height	19.9 mm

Classification

ECLASS 8.1	27440605
ETIM 7.0	EC002560
ETIM 6.0	EC002560
ETIM 5.0	EC002560
ETIM 4.0	EC002560



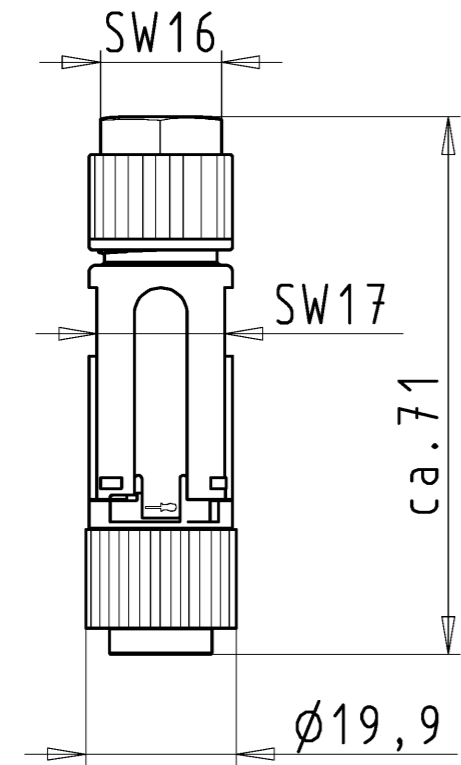

Note

Note	fine-stranded and stranded wires have to be used without ferrules
------	---

These dimensions will be especially checked at delivery
 Only inspection dimensions
 With /E marked dimensions are only valid for internal use
 Diese Maße werden bei Abnahme besonders geprüft
 Ausschließlich Prüfmaße
 Mit /E gekennzeichnete Maße sind nur für interne Zwecke gültig



Kodierung
/Coding

-  C1
-  C2
-  C3
-  C4
-  C5

Auslieferungszustand
/delivery condition

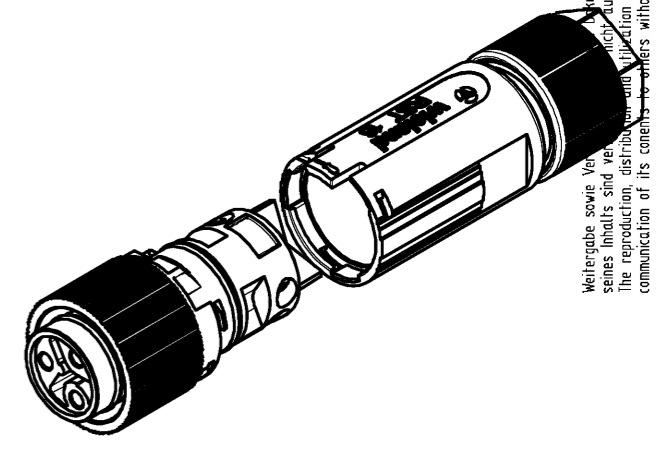
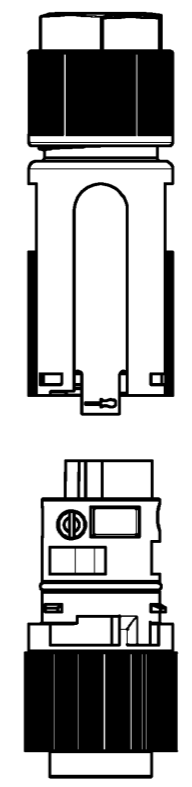

Weitergabe sowie Verwertung des Dokuments, Verwertung und Mitteilung seines Inhalts sind verbotlich ausdrücklich gestattet.
 The reproduction, distribution and application of this document as well as the communication of its contents to others without express authorization is prohibited.

46.031.4550.6	RST16 I3	S B1 ZT4S A TB	C5	türkisblau /turquoise blue
46.031.4553.9	RST16 I3	S B1 ZT4S H BL	C4	lichtblau /light blue
46.031.4550.4	RST16 I3	S B1 ZT4S L BR	C3	signalbraun /signal brown
46.031.4555.7	RST16 I3	S B1 ZT4S GN	C2	laubgrün /leaf green
46.031.4553.1	RST16 I3	S B1 ZT4 SW	C1	schwarz /black
46.031.4553.0	RST16 I3	S B1 ZT4 GL	C1	lichtgrau /light grey

Bestellnummer /Order number	Typ /Type	Kodierung /Coding	Farbe /Colour
--------------------------------	--------------	----------------------	------------------

Weitere Daten siehe KATALOG oder eKatalog.
Additional data see CATALOG or eCatalog. www.wieland-electric.com
eshop.wieland-electric.com

Tolerierung Size ISO 14405 (Tolerance system Size ISO 14405).
 (This ISO-standard describes the envelope principle. According to the envelope principle the deviations of form and parallelism are limited by the size tolerances).

ja/yes Stoffverbots- und Deklarationsliste nach WN 5020.010 ist einzuhalten.
 Conformity with Wieland document WN 5020.010 e (list of prohibited / declarable hazardous substances) to be declared!

Freitoleranz nach General tolerance	CAD - Zeichnung, keine manuellen Änderungen CAD - drawing, no manual modifications allowed	1. Verwendung: First Use: -	Blatt: 1 von 1 Sheet: of 1
Werkstoff/Material	2014 Tag/Date Name	Zeichnung Nr./Drawing No. Index	
Maßstab/Scale 1:1	gezeichnet/drawn 02.09. Treschan geprüft/checked Normgepr./Stand. check	T 46.031.4553.0 13K a	
Vol. mm ³ / Of. / Surf. mm ²	Ersatz für/Replacement for: -	Maße in mm/Dimensions are in mm	
www.wieland-electric.com	Type Benennung/Title	BUCHSENTE I L FA - mit Zugentlastung, 3-polig female, with strain relief, 3 poles	
Änderung/Revision	www.wieland-electric.com	RST16..	