

SSSS7 2(H)mm, 2mm-travel Type

Compact general purpose type
with specifiable soldering method

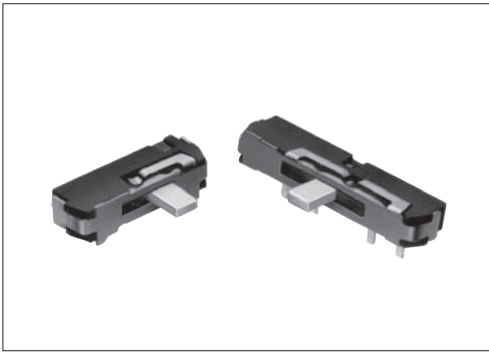

Typical Specifications

Items		Specifications
Rating (max.)/(min.) (Resistive load)		0.3A 4V DC / 50μA 3V DC
Contact resistance (Initial performance / After lifetime)		70mΩ max. / 130mΩ max.
Operating force		Refer to the dimensions.
Operating life	Without load	10,000 cycles
	With load	10,000 cycles (0.3A 4V DC)

Product Line

Travel (mm)	Actuator direction	Actuator length (mm)	Poles	Positions	Changeover timing	Soldering	Operation	Minimum order unit (pcs.)		Products No.	Drawing No.
								Japan	Export		
2	Horizontal	2	1	2	Not specified	Manual	Standard	100	50,000	SSSS710100	1
						Reflow		2,000	8,000	SSSS710607	2
				3	Non shorting	Manual		100	40,000	SSSS711100	3
						Reflow		2,000	8,000	SSSS711403	4

Packing Specifications

Taping

Product No.	Number of packages (pcs.)			Reel width W (mm)	Tape width (mm)	Export package measurements (mm)
	1 reel	1 case /Japan	1 case /export packing			
SSSS710607	2,000	4,000	8,000	17.4	16	417×409×139
SSSS711403						406×406×190

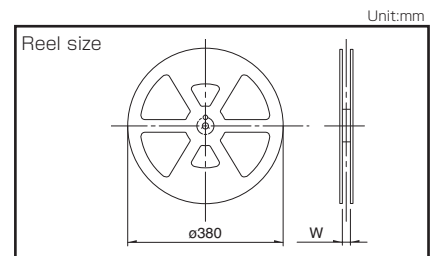

Bulk

Product No.	Number of packages (pcs.)		Export package measurements (mm)
	1 case /Japan	1 case /export packing	
SSSS710100	10,000	50,000	400×270×290
SSSS711100	8,000	40,000	

Detector

Slide

Push

Rotary

Power

Dual-In-line
Package Type

Small size
General Use Type

Big size
General Use Type

SSSS7 2(H)mm, 2mm-travel Type

Detector
 Slide
 Push
 Rotary
 Power
 Dual-In-Line Package Type
 Small size General Use Type
 Big size General Use Type

■ Dimensions

Unit:mm

No.	Photo	Style	PC board mounting hole dimensions (Viewed from direction A)
1	1-pole, 2-position 	<p>Terminal No. ①</p> <p>Operating force with detent : 1.5N</p>	<p>3-ϕ0.6 hole</p>
2	1-pole, 2-position Reflow 	<p>Terminal No. ①</p> <p>Operating force with detent : 1.5N</p>	<p>2-ϕ0.8 hole</p>
3	1-pole, 3-position 	<p>Terminal No. ①</p> <p>Operating force with detent : a \rightarrow b } 1.75N c \rightarrow b } b \rightarrow a } 2.5N b \rightarrow c }</p>	<p>4-ϕ0.6 hole</p>
4	1-pole, 3-position Reflow 	<p>Terminal No. ①</p> <p>Operating force with detent : a \rightarrow b } 1.75N c \rightarrow b } b \rightarrow a } 2.5N b \rightarrow c }</p>	<p>2-ϕ0.8 hole</p>

■ Detail of ① Unit:mm

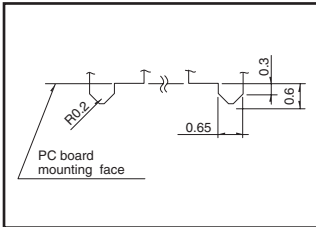



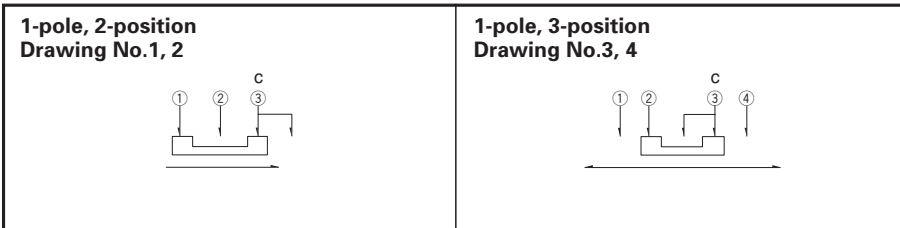









■ Circuit Diagram (Viewed from Direction A)



Detector
Slide
Push
Rotary
Power
Dual-In-line Package Type
Small size General Use Type
Big size General Use Type

Slide Switches

List of Varieties

Series		SSAJ	SSAH	SSSS8※	SSAL	SSAG	SSSS7
Photo							
Actuator direction	Horizontal	●	●	●	●	●	●
	Vertical	—	—	●	—	—	—
Poles-positions	1-2	●	—	●	●	—	●
	1-3	—	●	●	—	●	●
	1-4	—	—	—	—	—	—
	2-2	—	—	●	—	—	—
	2-3	—	—	●	—	—	—
	2-4	—	—	—	—	—	—
	4-2	—	—	—	—	—	—
Travel (mm)		1.4	1.5	1.5, 2	2	1.5	2
Operating temperature range		-10°C to +60°C	-30°C to +60°C	-40°C to +85°C	-10°C to +60°C		-40°C to +85°C
Automotive use		—	—	—	—	—	—
Life cycle							
Rating (max.) (Resistive load)		10mA 5V DC	1mA 5V DC	0.3A 5V DC	10mA 5V DC		0.3A 4V DC
Rating (min.) (Resistive load)		50μA 3V DC					
Durability	Operating life without load	10,000 cycles 500mΩ max.	10,000 cycles 300mΩ max.	10,000 cycles 100mΩ max.	100,000 cycles 10Ω max.	30,000 cycles (Lock side) 100,000 cycles (Recoil side) 500mΩ max.	10,000 cycles 100mΩ max.
	Operating life with load Load: as rating			10,000 cycles 130mΩ max.			
Electrical performance	Initial contact resistance	300mΩ max.	200mΩ max.	70mΩ max.	10Ω max.	200mΩ max.	70mΩ max.
	Insulation resistance	100MΩ min. 100V DC					
	Voltage proof	100V AC for 1minute					
Mechanical performance	Terminal strength		3N for 1minute				
	Actuator strength	Operating direction	10N				
		Pulling direction					
Environmental performance	Cold	-40°C 96h		-40°C 500h	-40°C 96h		-20°C 500h
	Dry heat	85°C 96h		85°C 500h	85°C 96h		85°C 500h
	Damp heat	40°C, 90 to 95%RH 96h	60°C, 90 to 95%RH 240h	60°C, 90 to 95%RH 500h	40°C, 90 to 95%RH 96h		60°C, 90 to 95%RH 500h
Page		75	77	79	82	84	87

Slide Switches Soldering Conditions	111
Slide Switches Cautions	112

Notes

- ※ The operating temperature range for automotive applications can be raised upon request. Please contact us for details.
- Indicates applicability to all products in the series.

Slide Switches Soldering Conditions

Example of Reflow Soldering Condition

1. Heating method: Double heating method with infrared heater.
2. Temperature measurement: Thermocouple ϕ 0.1 to 0.2 CA (K) or CC (T) at soldering portion (copper foil surface).
A heat resisting tape should be used for fixed measurement.
3. Temperature profile

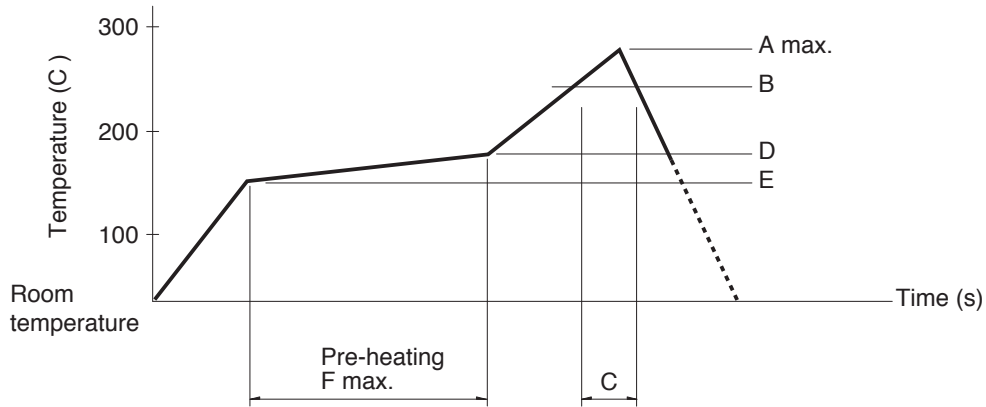

Series (Reflow type)		A (°C) 3s max.	B (°C)	C (s)	D (°C)	E (°C)	F (s)
SSSS2	Vertical 1-pole, 3-position	260	230	40	180	150	120
	Horizontal 1-pole, 2-position 1-pole, 3-position 2-pole, 3-position						
	Vertical 1-pole, 2-position	250					
SSSS7		260					
SSAH, SSAG, SSAJ, SSAL, SSSS8		260					

Notes

1. The condition mentioned above is the temperature on the mounting surface of a PC board. There are cases where the PC board's temperature greatly differs from that of the switch, depending on the PC board's material, size, thickness, etc. The above-stated conditions shall also apply to switch surface temperatures.
2. Soldering conditions differ depending on reflow soldering machines. Prior verification of soldering condition is highly recommended.

Reference for Hand Soldering

Series	Soldering temperature	Soldering time
SSSF, SSSU	350±10°C	3+1/0s
SSSS2	350±10°C	4s max.
SSSS9	350±10°C	3s max.
SSAH, SSAG, SSAJ, SSAL	350±5°C	3s max.
SSSS8	330±5°C	3s max.
SSSS7	320±5°C	3s max.
SSAC	300±10°C	2s max.

Reference for Dip Soldering

(For PC board terminal types)

Series	Items		Dip soldering	
	Preheating temperature	Preheating time	Soldering temperature	Duration of immersion
SSSS2	100°C max.	60s max.	260±5°C	3±1s
SSSS9	120°C max.	60s max.	260±5°C	5+0/-1s (2 times)
SSSF, SSSU	100°C max.	60s max.	260±5°C	10±1s/5±1s
SSAC	100°C max.	60s max.	260±5°C	5±1s