

Description

The 0805 series provides miniature surface mount resettable Over-current protection with holding current from 0.02A to 3.0A. This series is suitable for ultra portable applications where space is at a premium and the device current is low.



Features

- I(hold): 0.02~3.0A
- Very high voltage surge capabilities
- Available in lead-free version
- Fast response to fault current
- RoHS compliant, Lead- Free and Halogen-Free
- Low resistance
- Compact design saves board space
- Compatible with high temperature solders

Applications

- USB peripherals
- Disk drives
- CD-ROMs
- General electronics
- Disk drives
- Set-top-box and HDMI
- Mobile Internet Device (MID)
- PDAs / digital cameras
- Game console port protection
- Plug and play protection for motherboards and peripherals
- Mobile phones - battery and port protection

Part Number Code

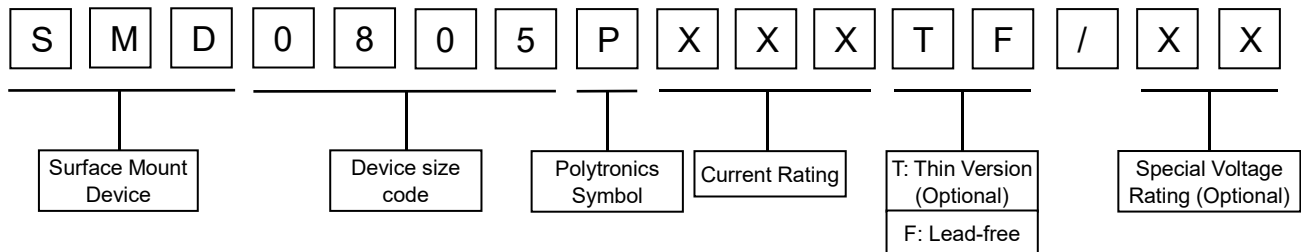

Environmental Specifications

Test	Conditions	Resistance change
Passive aging	+85°C, 1000 hrs	±5% typical
Humidity aging	+85°C, 85%R.H., 168 hours	±5% typical
Thermal shock	+85°C to -40°C, 20times	±33% typical
Resistance to solvent	MIL-STD-202, Method 215	No change
Vibration	MIL-STD-202, Method 201	No change

Ambient operating conditions : - 40°C to +85°C

Maximum surface temperature of the device in the tripped state is 125 °C

Performance Specification

Type Number	Marking	I_{hold}	I_{trip}	V_{max}	Max. Time to Trip		I_{max}	P_d typ	$R_{i_{min}}$	$R_{1_{max}}$
		A	A	V_{DC}	Current A	T_{max} S	A	W	Ω	Ω
SMD0805P002TF	Y	0.02	0.06	60	0.2	1.0	20	0.5	12.00	70.00
SMD0805P005TF	1	0.05	0.15	15	0.5	1.50	30	0.5	1.50	18
SMD0805P005TF/30	1	0.05	0.15	30	0.5	1.50	30	0.5	1.50	18
SMD0805P010TF	1	0.10	0.30	15	0.5	1.50	30	0.5	0.75	6
SMD0805P010TF/24	1	0.10	0.30	24	0.5	1.50	30	0.5	0.75	6
SMD0805P010TF/30	1	0.10	0.30	30	0.5	1.50	30	0.5	0.75	6
SMD0805P020TF	2	0.20	0.50	9	8	0.02	30	0.5	0.50	3.5
SMD0805P020TF/12	2	0.20	0.50	12	8	0.02	30	0.5	0.50	3.5
SMD0805P020TF/16	2	0.20	0.50	16	8	0.02	30	0.5	0.50	3.5
SMD0805P020TF/24	2	0.20	0.50	24	8	0.02	30	0.5	0.55	3.5
SMD0805P035TF	3	0.35	0.75	6	8	0.10	30	0.5	0.20	1.2
SMD0805P035TF/12	3	0.35	0.75	12	8	0.10	30	0.5	0.20	1.2
SMD0805P050TF	5	0.50	1.00	6	8	0.10	30	0.5	0.10	0.85
SMD0805P050TF/12	5	0.50	1.00	12	8	0.10	30	0.5	0.10	0.85
SMD0805P050TF/16	5	0.50	1.00	16	8	0.10	30	0.5	0.10	0.85
SMD0805P050TF/24	5	0.50	1.00	24	8	0.10	30	0.5	0.10	0.85
SMD0805P075TF	7	0.75	1.50	6	8	0.20	35	0.6	0.07	0.385
SMD0805P075TF/12	7	0.75	1.50	12	8	0.20	35	0.6	0.07	0.385
SMD0805P100TF	0	1.00	1.95	6	8	0.30	35	0.6	0.04	0.23
SMD0805P100TF/12	0	1.00	1.95	12	8	0.30	35	0.6	0.04	0.23
SMD0805P110TF	0	1.10	2.20	6	8	0.30	35	0.6	0.035	0.21
SMD0805P110TF/12	0	1.10	2.20	12	8	0.30	35	0.6	0.035	0.21
SMD0805P125TF	12	1.25	2.50	6	8	0.60	35	1.5	0.025	0.14
SMD0805P150TF	15	1.50	3.00	6	8	0.50	35	1.0	0.015	0.13
SMD0805P200TF	E	2.00	4.00	6	10	2.00	50	0.7	0.006	0.045
SMD0805P300TF/12	H	3.00	6.00	12	15	2.00	50	0.8	0.003	0.03

V_{max} = Maximum operating voltage device can withstand without damage at rated current (I_{max}).

I_{max} = Maximum fault current device can withstand without damage at rated voltage (V_{max}).

I_{hold} = Hold Current. Maximum current device will not trip in 25°C still air.

I_{trip} = Trip Current. Minimum current at which the device will always trip in 25°C still air.

P_d = Power dissipation when device is in the tripped state in 25°C still air environment at rated voltage.

$R_{i\ min/max}$ = Minimum/Maximum device resistance prior to tripping at 25°C.

$R_{1\ max}$ = Maximum device resistance is measured one hour post reflow.

Thermal Derating Chart-Ih(A)

Part Number	Ambient Operation Temperature								
	-40 °C	-20 °C	0 °C	25 °C	40 °C	50 °C	60 °C	70 °C	85 °C
SMD0805P002TF	0.031	0.027	0.024	0.020	0.016	0.014	0.012	0.011	0.007
SMD0805P005TF	0.07	0.06	0.055	0.05	0.04	0.035	0.03	0.025	0.015
SMD0805P005TF/30	0.07	0.06	0.055	0.05	0.04	0.035	0.03	0.025	0.015
SMD0805P010TF	0.14	0.12	0.11	0.1	0.08	0.07	0.06	0.05	0.03
SMD0805P010TF/24	0.14	0.12	0.11	0.1	0.08	0.07	0.06	0.05	0.03
SMD0805P010TF/30	0.14	0.12	0.11	0.1	0.08	0.07	0.06	0.05	0.03
SMD0805P020TF	0.28	0.25	0.23	0.20	0.17	0.14	0.12	0.10	0.07
SMD0805P020TF/12	0.28	0.25	0.23	0.20	0.17	0.14	0.12	0.10	0.07
SMD0805P020TF/16	0.28	0.25	0.23	0.20	0.17	0.14	0.12	0.10	0.07
SMD0805P020TF/24	0.28	0.25	0.23	0.20	0.17	0.14	0.12	0.10	0.07
SMD0805P035TF	0.47	0.44	0.39	0.35	0.30	0.27	0.24	0.20	0.14
SMD0805P035TF/12	0.47	0.44	0.39	0.35	0.30	0.27	0.24	0.20	0.14
SMD0805P050TF	0.68	0.62	0.55	0.50	0.40	0.37	0.33	0.29	0.23
SMD0805P050TF/12	0.68	0.62	0.55	0.50	0.40	0.37	0.33	0.29	0.23
SMD0805P050TF/16	0.68	0.62	0.55	0.50	0.40	0.37	0.33	0.29	0.23
SMD0805P050TF/24	0.68	0.62	0.55	0.50	0.40	0.37	0.33	0.29	0.23
SMD0805P075TF	1.00	0.90	0.79	0.75	0.63	0.57	0.53	0.41	0.34
SMD0805P075TF/12	1.00	0.90	0.79	0.75	0.63	0.57	0.53	0.41	0.34
SMD0805P100TF	1.35	1.25	1.15	1.00	0.82	0.74	0.65	0.55	0.42
SMD0805P100TF/12	1.35	1.25	1.15	1.00	0.82	0.74	0.65	0.55	0.42
SMD0805P110TF	1.45	1.35	1.20	1.10	0.92	0.84	0.75	0.65	0.52
SMD0805P110TF/12	1.45	1.35	1.20	1.10	0.92	0.84	0.75	0.65	0.52
SMD0805P125TF	1.65	1.53	1.36	1.25	1.05	0.95	0.85	0.74	0.59
SMD0805P150TF	1.98	1.84	1.63	1.50	1.26	1.14	1.02	0.88	0.71
SMD0805P300TF/12	4.29	3.75	3.53	3.00	2.65	2.50	2.40	1.94	1.36

Thermal Derating Curve

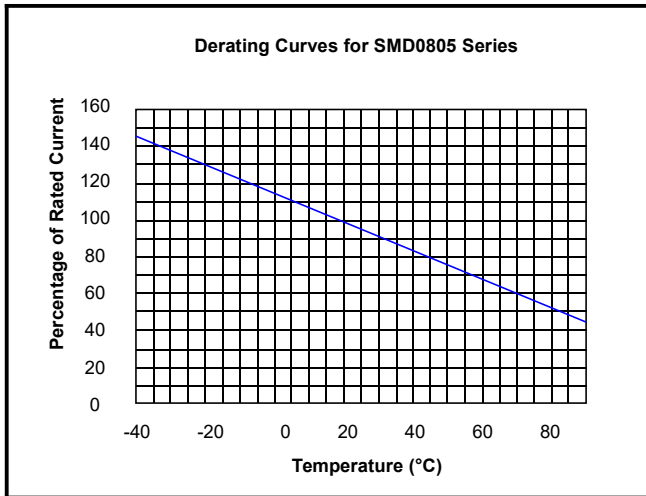

Average Time-Current Curve

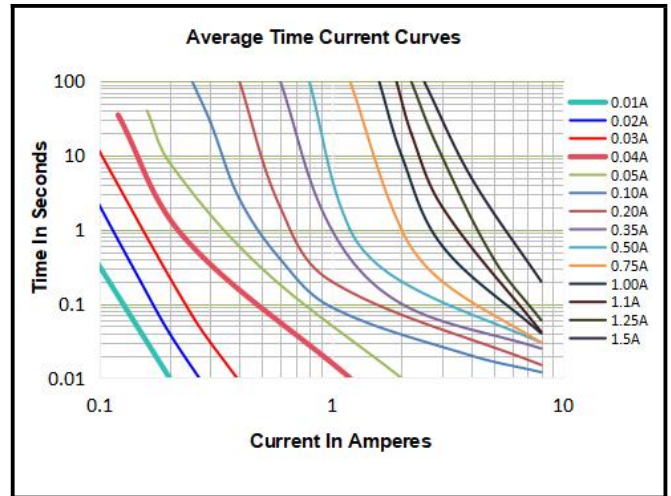

Soldering Parameters

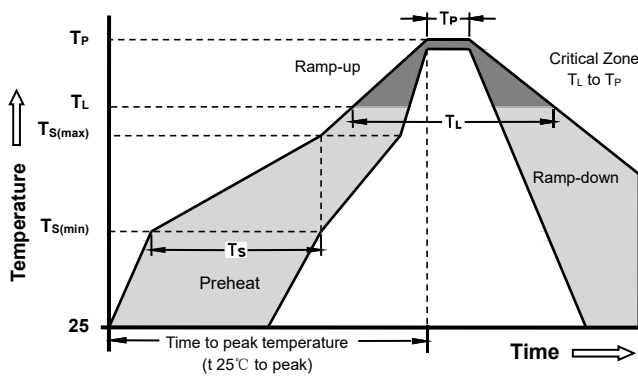

Reflow Condition		Pb - Free assembly
Pre Heat	-Temperature Min ($T_{S(min)}$)	150°C
	-Temperature Max ($T_{S(max)}$)	200°C
	- Time (min to max) (t_s)	60 -180 Seconds
Average ramp up rate (Liquids Temp T_L to peak)		3°C/second max
$T_{S(max)}$ to T_L - Ramp-up Rate		3°C/second max
Reflow	- Temperature (T_L) (Liquids)	217°C
	- Time (min to max) (t_s)	60 -150 Seconds
Peak Temperature (T_P)		260 +0/-5°C
Time within 5°C of actual peak Temperature (t_p)		20 - 40 Seconds
Ramp-down Rate		6°C/second max
Time 25°C to peak Temperature (T_P)		8 minutes Max
Do not exceed		260°C

Dimensions

Type Number	Package Dimensions (mm)							Package Dimensions (in)						
	A		B		C		D	A		B		C		D
	min	max	min	max	min	max	min	min	max	min	max	min	max	min
SMD0805P002TF	2	2.2	1.2	1.5	0.4	0.9	0.2	0.079	0.087	0.047	0.059	0.016	0.035	0.008
SMD0805P005TF	2	2.2	1.2	1.5	0.4	1.0	0.2	0.079	0.087	0.047	0.059	0.016	0.039	0.008
SMD0805P005TF/30	2	2.2	1.2	1.5	0.4	1.0	0.2	0.079	0.087	0.047	0.059	0.016	0.039	0.008
SMD0805P010TF	2	2.2	1.2	1.5	0.4	1.0	0.2	0.079	0.087	0.047	0.059	0.016	0.039	0.008
SMD0805P010TF/24	2	2.2	1.2	1.5	0.4	1.0	0.2	0.079	0.087	0.047	0.059	0.016	0.039	0.008
SMD0805P010TF/30	2	2.2	1.2	1.5	0.4	1.0	0.2	0.079	0.087	0.047	0.059	0.016	0.039	0.008
SMD0805P020TF	2	2.2	1.2	1.5	0.35	1.0	0.2	0.079	0.087	0.047	0.059	0.014	0.039	0.008
SMD0805P020TF/12	2	2.2	1.2	1.5	0.35	1.0	0.2	0.079	0.087	0.047	0.059	0.014	0.039	0.008
SMD0805P020TF/16	2	2.2	1.2	1.5	0.35	1.0	0.2	0.079	0.087	0.047	0.059	0.014	0.039	0.008
SMD0805P020TF/24	2	2.2	1.2	1.5	0.35	0.8	0.2	0.079	0.087	0.047	0.059	0.014	0.032	0.008
SMD0805P035TF	2	2.2	1.2	1.5	0.35	1.0	0.2	0.079	0.087	0.047	0.059	0.014	0.039	0.008
SMD0805P035TF/12	2	2.2	1.2	1.5	0.35	1.0	0.2	0.079	0.087	0.047	0.059	0.014	0.039	0.008
SMD0805P050TF	2	2.2	1.2	1.5	0.30	1.1	0.2	0.079	0.087	0.047	0.059	0.012	0.043	0.008
SMD0805P050TF/12	2	2.2	1.2	1.5	0.30	1.1	0.2	0.079	0.087	0.047	0.059	0.012	0.043	0.008
SMD0805P050TF/16	2	2.2	1.2	1.5	0.5	1.1	0.2	0.079	0.087	0.047	0.059	0.02	0.043	0.008
SMD0805P050TF/24	2	2.2	1.2	1.5	0.5	1.1	0.2	0.079	0.087	0.047	0.059	0.02	0.043	0.008
SMD0805P075TF	2	2.2	1.2	1.5	0.4	1.3	0.2	0.079	0.087	0.047	0.059	0.016	0.051	0.008
SMD0805P075TF/12	2	2.2	1.2	1.5	0.4	1.3	0.2	0.079	0.087	0.047	0.059	0.016	0.051	0.008
SMD0805P100TF	2	2.2	1.2	1.5	0.5	1.3	0.2	0.079	0.087	0.047	0.059	0.02	0.051	0.008
SMD0805P100TF/12	2	2.2	1.2	1.5	0.5	1.3	0.2	0.079	0.087	0.047	0.059	0.02	0.051	0.008
SMD0805P110TF	2	2.2	1.2	1.5	0.5	1.3	0.2	0.079	0.087	0.047	0.059	0.02	0.051	0.008
SMD0805P110TF/12	2	2.2	1.2	1.5	0.5	1.3	0.2	0.079	0.087	0.047	0.059	0.02	0.051	0.008
SMD0805P125TF	2	2.2	1.2	1.5	1.0	1.5	0.2	0.079	0.087	0.047	0.059	0.039	0.059	0.008
SMD0805P150TF	2	2.2	1.2	1.5	1.0	1.5	0.2	0.079	0.087	0.047	0.059	0.039	0.059	0.008
SMD0805P200TF	2	2.2	1.2	1.5	0.4	1.2	0.2	0.079	0.087	0.047	0.059	0.016	0.047	0.008
SMD0805P300TF/12	2	2.2	1.2	1.5	0.5	1.4	0.2	0.079	0.087	0.047	0.059	0.02	0.055	0.008

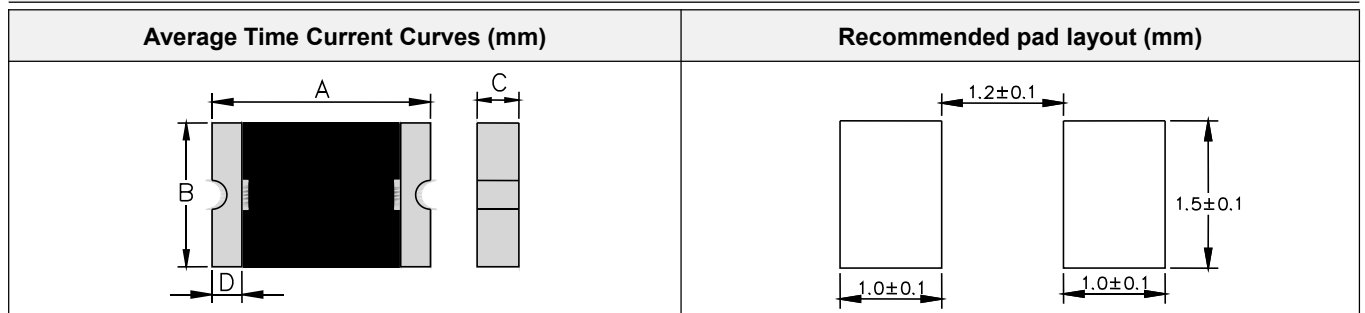

Taping and Reel Specifications

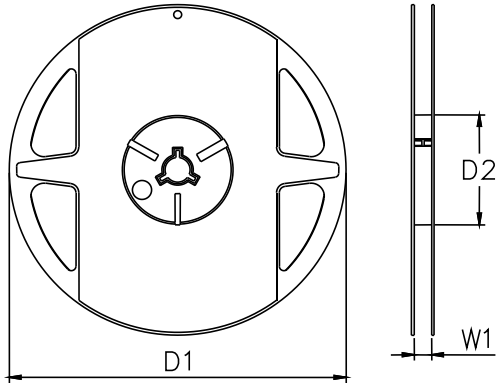
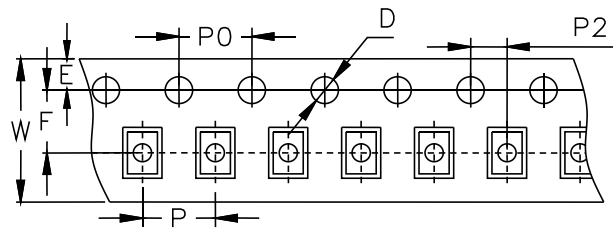

Symbol	Millimeters	Inches
W	8±0.3	0.315±0.012
P	4±0.1	0.157±0.004
P0	4±0.1	0.157±0.004
P2	2±0.05	0.079±0.002
F	3.5±0.05	0.138±0.002
E	1.75±0.1	0.069±0.004
D	1.55±0.05	0.061±0.002
D1(max)	178	7.007
D2(min)	60	2.362
W1	9.0±0.5	0.354±0.02

Storage And Handling

Storage conditions: keep away from sunlight, sealed devices may not meet specified performance if storage conditions are exceeded.

Model	Quantity
SMD0805P002TF~ SMD0805P050TF	5000PCS
SMD0805P050TF/12,SMD0805P050TF/16, SMD0805P050TF/24,075TF,075TF/12	4000PCS
SMD0805P100TF~ SMD0805P200TF	3500PCS
SMD0805P300TF/12	3000PCS

SMD PTC 使用注意事项

Cautions for SMD PTC Use

1. 请在规格书规定的最大电压和最大电流下使用, 超出 PTC 最大电压或最大电流规格值的操作, 可能会导致 PTC 出现电弧, 阻值升高, 甚至烧片。

Operation beyond the maximum voltage or current may result in device damage and possible electrical arcing or flame.

2. 规格书所规定的各温度下的 Hold current 均是 PTC 经过一次回流焊接得出的常规性能, PTC 能够在不同温度对应的电流条件下保持 1 小时。该电流并不是该型号 PTC 能够适用的长期充电或放电电流的条件。

Hold current at all temperatures specified in the SPEC is the conventional performance of PTC obtained by one time reflow welding. PTC can hold 1 hour under current conditions at a given temperature. This current is not the condition of long-term charging or discharging current for this type of PTC.

3. 规格书所规定的电阻以及电气特性, 均是基于在瑞隆源指定测试板经过一次回流焊之后的测试。如果客户有二次回流焊或者注塑点胶等其他热工序, 会对上述参数有一定程度的衰减。所以需要验证其适用性。

The above parameters are concluded from one time of reflow soldering processing the PTC appointed by Ruilongyuan. If there is any further heat generated process like injection or dispensing at the customer's premise, the aforementioned parameters will decrease at certain degree. Therefore the verification test to be conducted is necessary.

4. PTC 为热敏元件, 对环境温度比较敏感, 建议在 PTC 周围不要设计热源元件, 尽量减少外部热源的影响。

The PTC is thermal sensitive device. It is recommended not to design any heat source devices around it to reduce the outside heat source impact.

5. PTC 贴片产品是为 SMT 工艺设计的封装形式, 焊接工艺为回流焊。焊接工艺可参考瑞隆源推荐的回流焊曲线。如果回流焊温度超过推荐的值, PTC 将有可能受到损伤。禁止使用手工焊接 PTC, 禁止对线路板其他元件或端子返工时使用热风枪。

SMD PTC is designed for SMT processing which applies reflow soldering. Please refer to the Ruilongyuan recommended curve for reference. If the reflow soldering temperature exceeds the recommended value, the PTC might be damaged. Hand welding PTC is prohibited. Heat gun is not allowed to use during the circuit board components or terminals rework.

6. PTC 贴装或应用过程中, 所使用到的各类注塑料、单组份、双组份固化胶粘剂、硅胶, 特种润滑理基脂, 石蜡, 需要对注塑料胶料等材料牌号以及应用参数 (如温度、时间等) 进行验证, 以确保产品及工艺的匹配性, 确认不会影响 PTC 性能之后方可使用。

When mounting or using PTC, all injection molding materials, curing adhesives, UV glue, special lubricating base grease, paraffin, silica gel and cleaning agents or solvents must be tested in terms of application parameters e.g. temperature, time, and etc to ensure the consistency between the product and the processing before use.

7. PTC 贴装或使用过程中, 不建议使用洗板水或其他清洗剂进行清洗。如必须使用, 需要验证各类清洗剂、洗板水以及溶剂的适用性, 确认不会影响 PTC 性能之后方可使用。已知对 PTC 有影响的化学药品包括但不限于醚类、苯类、酮类以及脂类等较强溶解性、破坏性的有机化合物。清洗后将产品放置于敞开的环境中至少 24 小时, 将残留的溶剂进行充分的挥发。

When mounting or using PTC, it is not recommended to use circuit board washer water or other cleaning agent. If cleaning is required, it is necessary to verify the applicability of various cleaning agents, washboard water and solvents, and confirm that they will not affect the PTC performance. The known chemicals that impacts PTC include

but not limited to ethers, benzene homolog, ketones, lipids and derivatives that is of strong solubleness and ruinous.

Please place the product in open environment for at least 24 hours to volatilize solvents residuals.

8. 装配过程中，避免用暴力砸、挤、压、拉、扭、刺等方式作用 PTC 本体，以免引起 PTC 性能衰减。

Please do not smash, clamp, pull, dent or twist by tool during assembling process otherwise it might be a cause of the performance degradation.

9. 在产品应用中，PTC 焊接至保护板后，如需注塑或打胶，须在尽量短的时间内完成，如贴装与注塑打胶时间间隔超过 1 个月，则需密闭保存，可避免 PTC 长时间暴露于空气环境中。

When PTC is welded to the PCM in product application, if injection or gluing is needed, it should be completed in as short a time as possible. If the time slot between mounting and injection or gluing surpasses 1 month, please keep in airtight environment to avoid long air exposure.

10. PTC 为自恢复保护元件，但不能当做开关使用，重复多次的保护会降低 PTC 的维持电流。

PTC is resettable protection device which shall not be taken for use as switch. Multiple times tripping shall lower the PTC hold current.

11. PTC 在充电线端应用中，建议使用 PP 类材料做内膜，禁止使用 TPE 类与 PVC 类等材料做内膜。

In charging terminal application, PP type material is recommended to use as inner membrane and TPE and PVC type material is inhibited.

12. PTC 在加工过程中，如有烙铁焊接工艺，建议焊接位置距离 PTC 1.5mm 以上，焊接工具温度低于 350℃，焊接铁头与焊点的接触时间不超过 3 秒。

In the process of PTC processing, if there is soldering iron welding process, it is suggested that the welding position should be more than 1.5mm away from PTC, the welding tool temperature should be lower than 350℃, and the contact time between soldering iron and solder joint should not exceed 3sec.

Specifications are subject to change without notice.