

SPECIFICATION

Ultra-Wideband Adhesive Type External Antenna

- Part No. : **GSA.8827.A.101111 Phoenix**
- Product Name : 4G/3G/2G Ultra-wideband I-Bar Antenna for First-Tier Automotive Application
- Feature : LTE / GSM / CDMA /DCS /PCS / WCDMA / UMTS / HSDPA / GPRS / EDGE / GPS / Wi-Fi
698MHz to 960MHz, 1575.42MHz,
1710MHz to 2700Mhz
1M RG-174 cable with SMA(M) connector
Low profile for easy installation
Fully customizable cable length and connector
105mm*30*7.7mm
RoHS compliant



1. Introduction

The GSA.8827 Phoenix Ultra-Wideband I-Bar antenna is a robust high efficiency cellular antenna for use with all 4G/3G/2G cellular modules worldwide.

Its slim-line design allows for covert and convenient installation in automotive vehicles, its omnidirectional gain across all bands ensures constant reception and transmission. GSA.8827 is manufactured and tested in a TS16949 first tier automotive approved facility, and it has gone through full PPAP design, reliability and quality audits.

The Phoenix finds its application particularly in first-tier automotive application, aftermarket and telematics.

With its unique ultra-wide band dipole design, the Phoenix has exceptional industry performance characteristics considering its very low profile at 7.7mm and has a compact size of only 105mm*30mm.

This antenna is designed to be mounted on glass or plastic (not on metal). It comes with strong 3M double-sided adhesive for a permanent and secure fix to your vehicle interior. The antenna is UV Resistant. Cable lengths and connectors are fully customizable.

2. Specification

ELECTRICAL									
Frequency (MHz)	703~803	824~894	880~960	1710 ~ 1880	1575.42	1850 ~ 1990	1710 ~ 2170	2490~2690	
Free Space Peak Gain (dBi)									
Cable length (meter)	0.3	1.21	1.46	2.70	2.67	2.99	3.32	3.43	1.67
	1	2.83	1.71	2.93	1.57	2.14	2.32	2.65	1.49
	2	1.51	1.70	2.87	0.54	0.77	0.78	1.10	-0.38
	3	-0.70	0.49	0.51	-0.93	-0.67	-0.47	-0.36	-1.66
Free Space Average Gain (dBi)									
Cable length (meter)	0.3	-3.36	-2.99	-2.08	-1.09	-1.53	-1.29	-1.08	-3.24
	1	-1.62	-3.06	-1.79	-2.09	-2.17	-2.20	-1.99	-4.02
	2	-3.30	-4.20	-3.81	-3.29	-3.68	-3.76	-3.59	-5.71
	3	-5.73	-4.83	-4.25	-4.35	-4.84	-4.87	-4.75	-7.17
Free Space Efficiency (%)									
Cable length (meter)	0.3	46.38	49.09	62.06	77.13	70.38	74.65	78.23	47.89
	1	69.63	52.93	67.41	61.68	59.94	61.68	63.92	39.71
	2	47.75	37.61	44.04	47.39	42.40	42.62	44.36	26.91
	3	26.88	34.17	37.59	37.10	32.35	33.07	33.64	19.28
On glass Peak Gain (dBi)									
Cable length (meter)	0.3	0.91	0.74	0.98	2.35	3.75	4.56	5.34	3.50
	1	2.79	1.90	-0.13	1.54	3.25	4.56	4.34	3.44
	2	0.34	1.47	1.65	0.97	1.53	2.30	2.69	1.47
	3	0.16	-0.43	-0.55	-0.28	0.51	0.84	1.13	-0.55
On glass Average Gain (dBi)									
Cable length (meter)	0.3	-2.63	-2.49	-2.67	-1.29	-1.35	-1.10	-1.03	-2.91
	1	-2.25	-3.14	-2.96	-2.22	-2.04	-1.98	-1.99	-3.85
	2	-3.78	-4.63	-3.65	-3.27	-3.63	-3.46	-3.50	-5.73
	3	-4.51	-4.90	-5.12	-4.59	-5.12	-5.02	-5.06	-7.62
On glass Efficiency (%)									
Cable length (meter)	0.3	54.84	56.39	54.13	74.28	73.29	77.81	80.31	51.78
	1	59.84	48.85	50.97	59.95	62.47	77.81	63.36	41.57
	2	42.41	34.53	43.29	47.10	43.36	45.17	44.80	26.95
	3	35.51	32.33	30.85	34.73	30.80	31.64	31.24	17.43

ELECTRICAL	
Impedance	50Ω
Polarization	Linear
Radiation Pattern	Omni
Input Power	50 W
MECHANICAL	
Casing	UV Resistant PC/ABS
Connector	SMA Male (customizable)
Cable	RG-174
Dimensions	105*30*7.7mm
Weight	50g
ENVIRONMENTAL	
Temperature Range	-40°C to 85°C
Humidity	Non-condensing 65°C 95% RH
Shock (Drop Test)	1m drop on concrete 6 axes
Cable Pull	8kgf

* After comparison, the antenna performance on the plastic base is the same with free space.

LTE BANDS			
Band Number	LTE / LTE-Advanced / WCDMA / HSPA / HSPA+ / TD-SCDMA		
	Uplink	Downlink	Covered
1	UL: 1920 to 1980	DL: 2110 to 2170	✓
2	UL: 1850 to 1910	DL: 1930 to 1990	✓
3	UL: 1710 to 1785	DL: 1805 to 1880	✓
4	UL: 1710 to 1755	DL: 2110 to 2155	✓
5	UL: 824 to 849	DL: 869 to 894	✓
7	UL: 2500 to 2570	DL: 2620 to 2690	✓
8	UL: 880 to 915	DL: 925 to 960	✓
9	UL: 1749.9 to 1784.9	DL: 1844.9 to 1879.9	✓
11	UL: 1427.9 to 1447.9	DL: 1475.9 to 1495.9	✗
12	UL: 699 to 716	DL: 729 to 746	✓
13	UL: 777 to 787	DL: 746 to 756	✓
14	UL: 788 to 798	DL: 758 to 768	✓
17	UL: 704 to 716	DL: 734 to 746 (LTE only)	✓
18	UL: 815 to 830	DL: 860 to 875 (LET only)	✓
19	UL: 830 to 845	DL: 875 to 890	✓
20	UL: 832 to 862	DL: 791 to 821	✓
21	UL: 1447.9 to 1462.9	DL: 1495.9 to 1510.9	✗
22	UL: 3410 to 3490	DL: 3510 to 3590	✓
23	UL: 2000 to 2020	DL: 2180 to 2200 (LTE only)	✓
24	UL: 1625.5 to 1660.5	DL: 1525 to 1559 (LTE only)	✓
25	UL: 1850 to 1915	DL: 1930 to 1995	✓
26	UL: 814 to 849	DL: 859 to 894	✓
27	UL: 807 to 824	DL: 852 to 869 (LTE only)	✓
28	UL: 703 to 748	DL: 758 to 803 (LTE only)	✓
29	UL: -	DL: 717 to 728 (LTE only)	✓
30	UL: 2305 to 2315	DL: 2350 to 2360 (LTE only)	✓
31	UL: 452.5 to 457.5	DL: 462.5 to 467.5 (LTE only)	✗
32	UL: -	DL: 1452 - 1496	✗
35		1850 to 1910	✓
38		2570 to 2620	✓
39		1880 to 1920	✓
40		2300 to 2400	✓
41		2496 to 2690	✓
42		3400 to 3600	✓
43		3600 to 3800	✗

*Covered bands represent an efficiency greater than 20%

3. Antenna Characteristics

3.1. Antenna Characteristics (In Free Space)

3.1.1. Return Loss

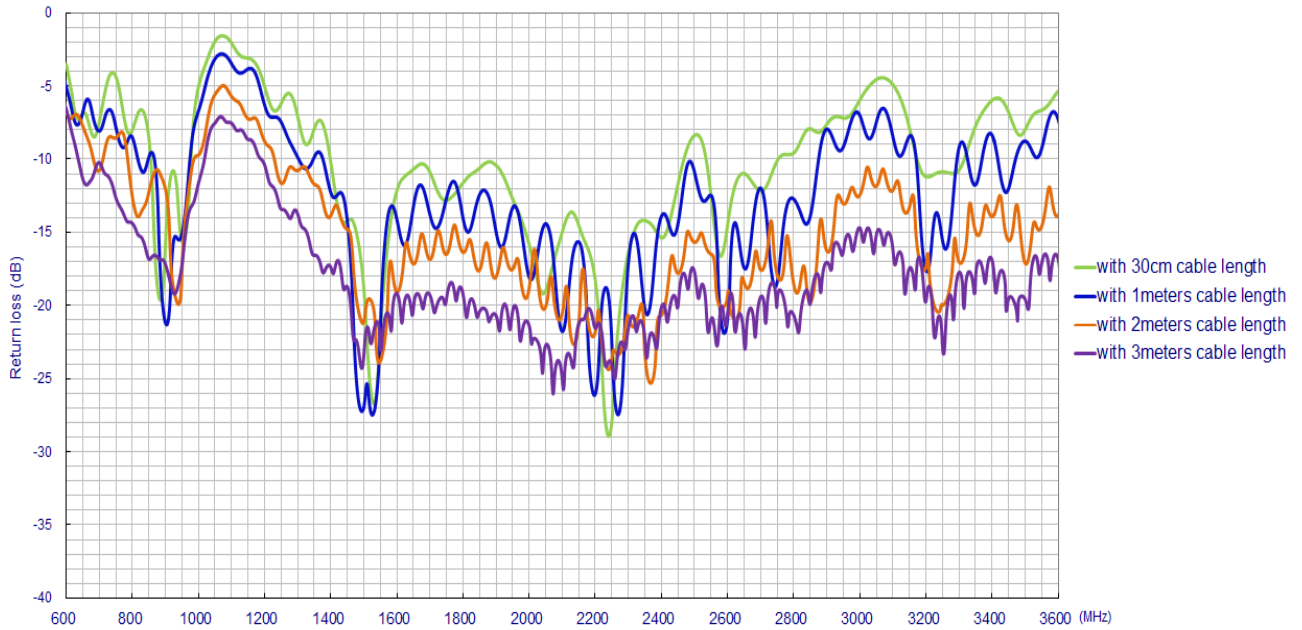

3.1.2. Peak Gain

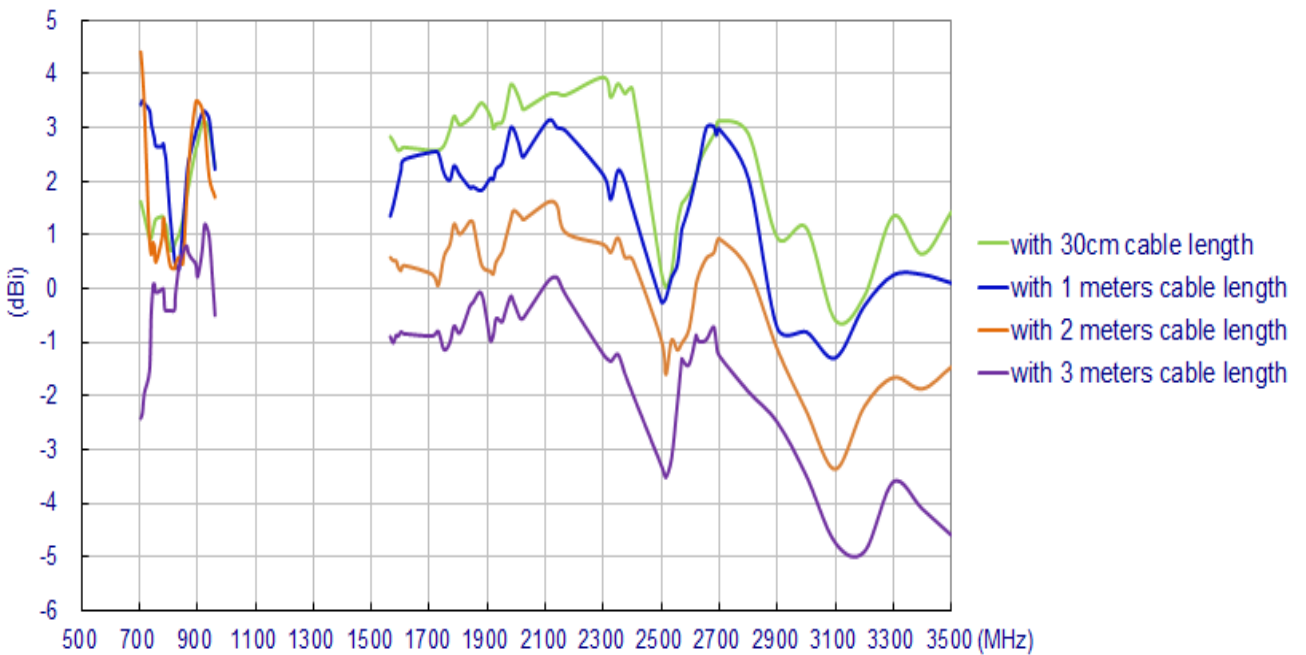

3.1.3. Average Gain

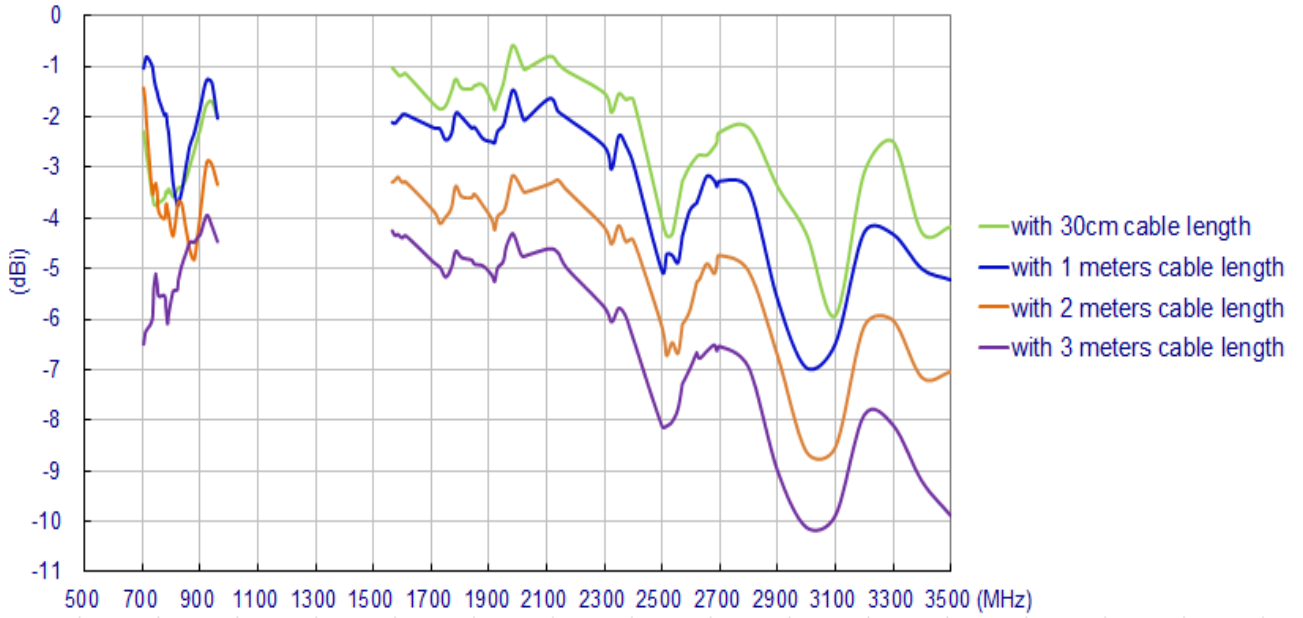

3.1.4. Efficiency

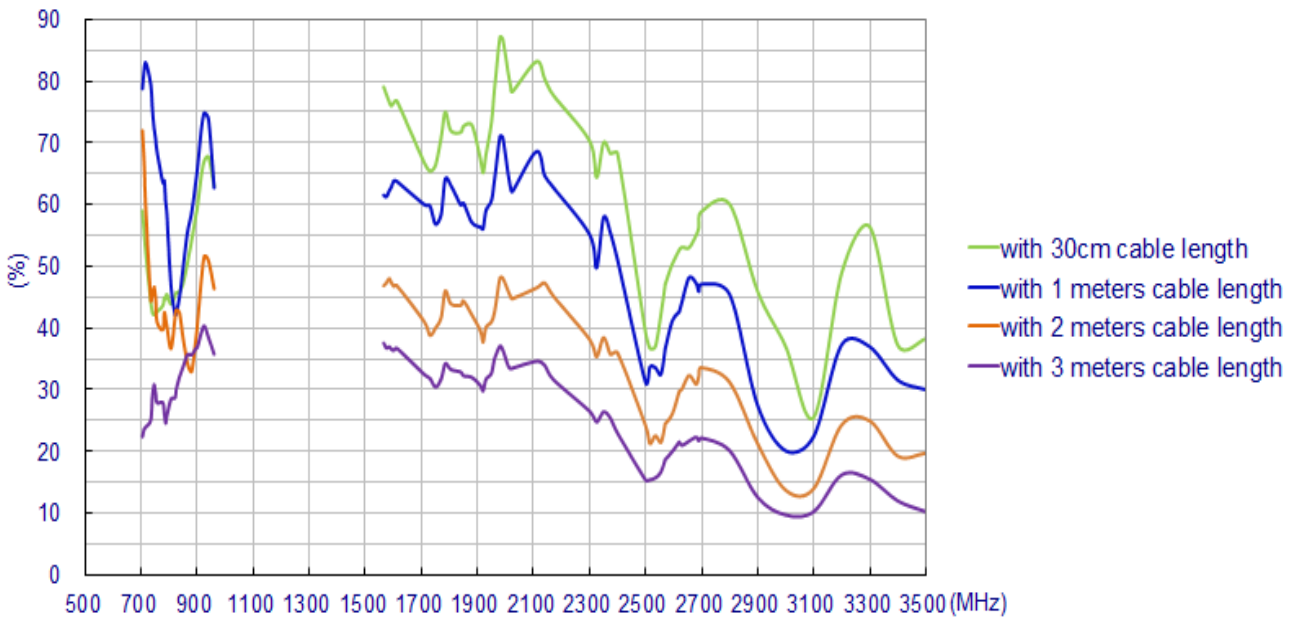

3.2. Antenna Characteristics (On Glass)

3.2.1. Return Loss

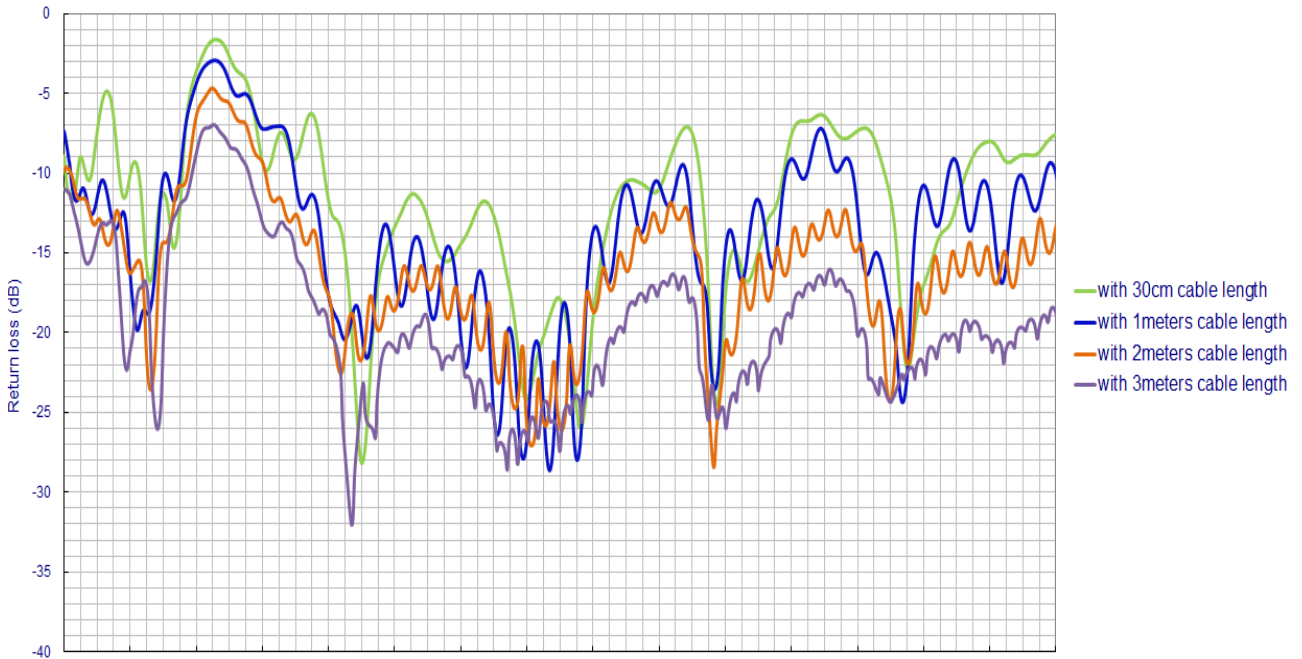

3.2.2. Peak Gain

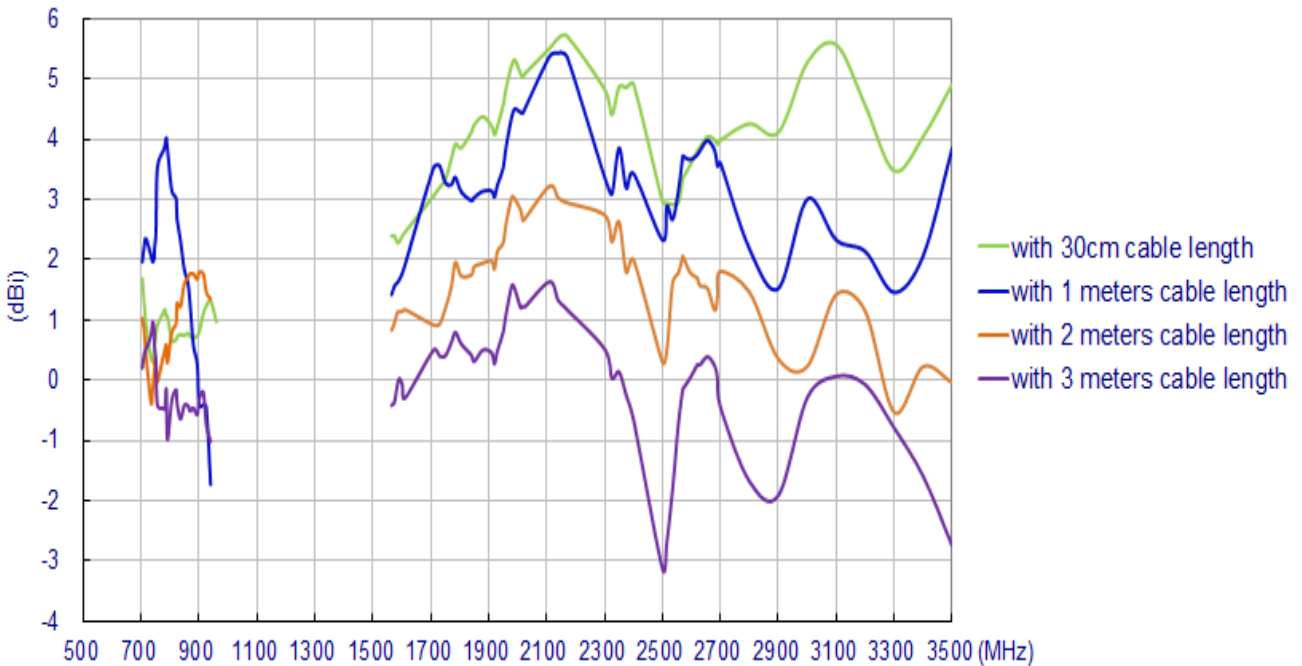

3.2.3. Average Gain

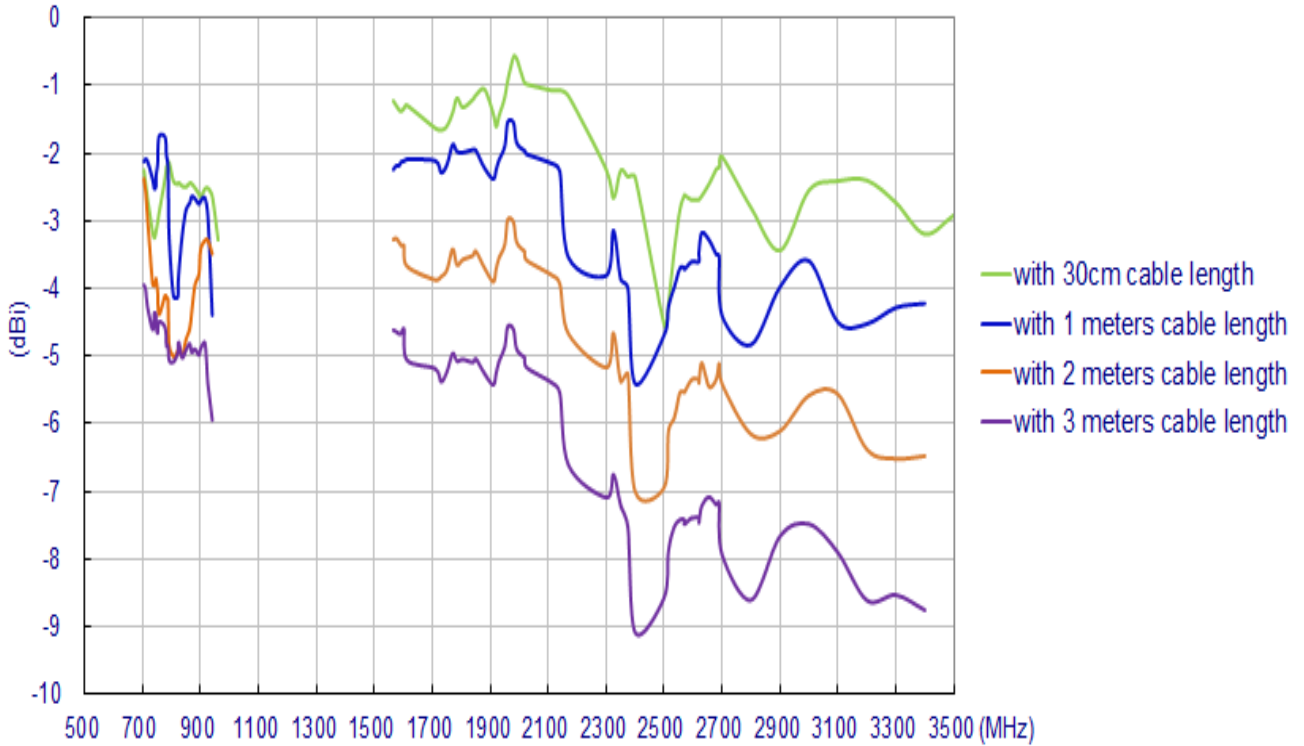

3.2.4. Efficiency

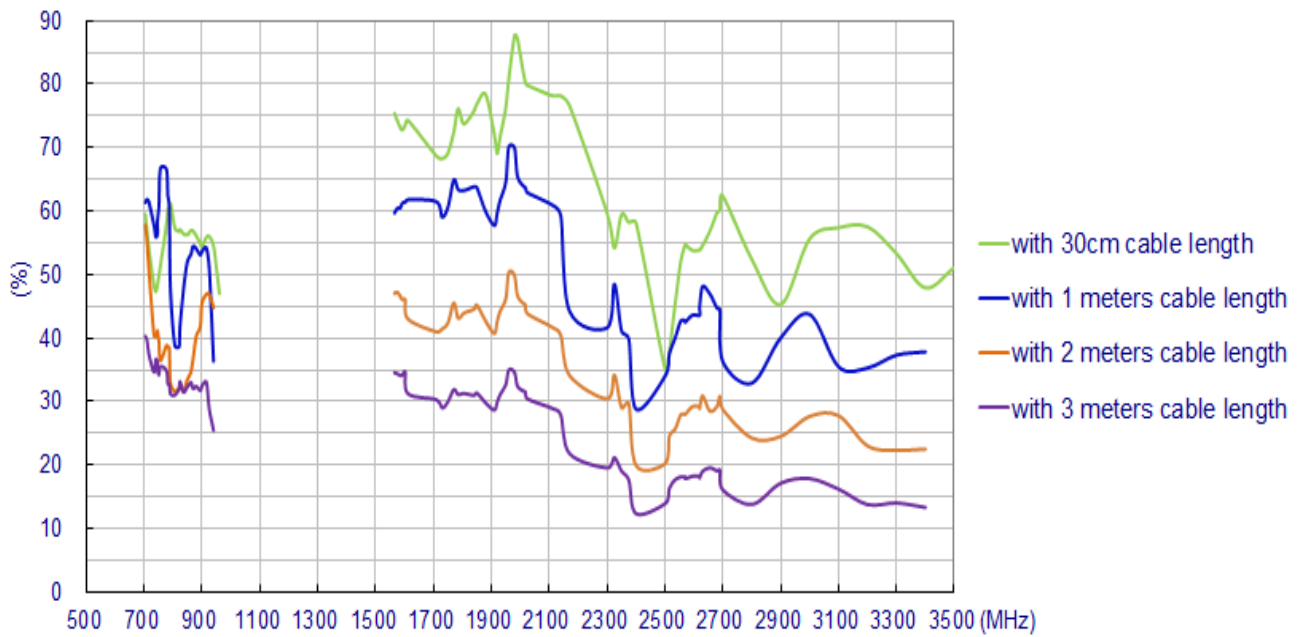

4. Antenna Radiation Patterns

4.1. Antenna Setup (Free Space with 1 Meter Cable Length)

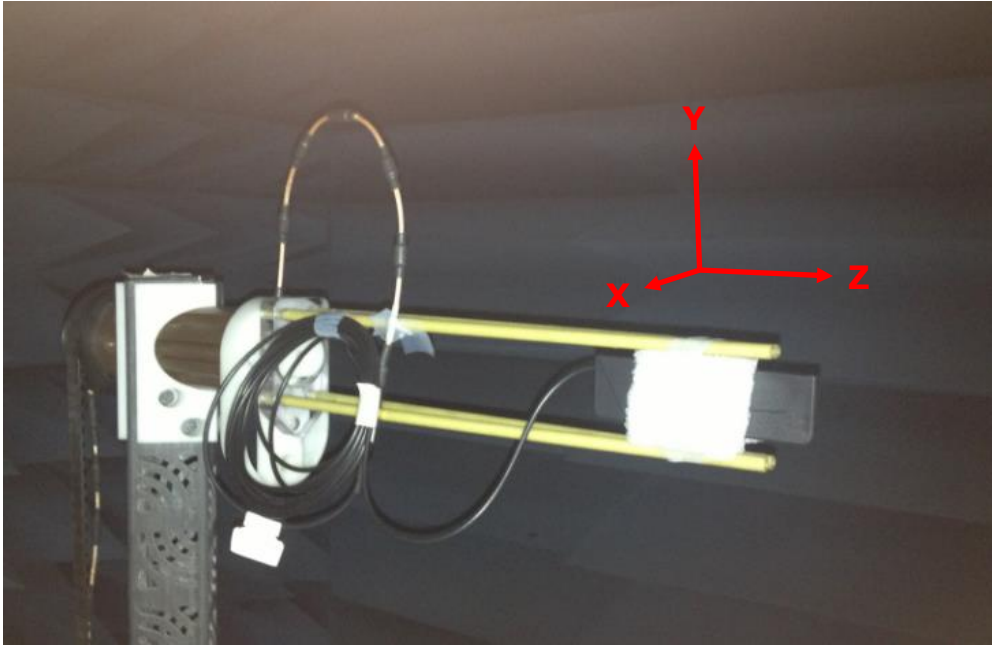

4.1.1. Radiation Patterns

XY Plane

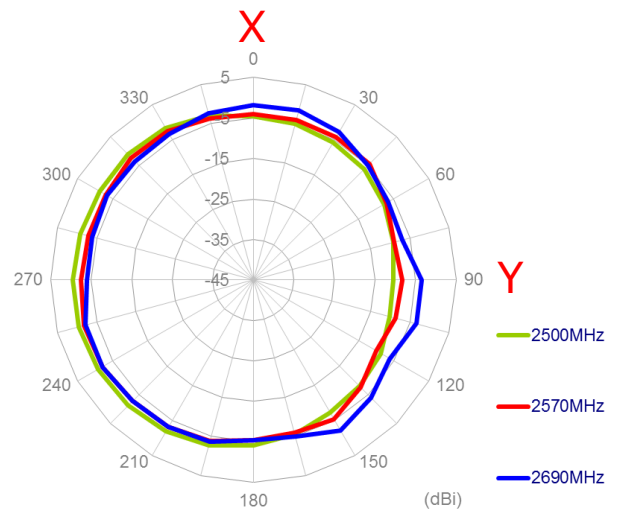
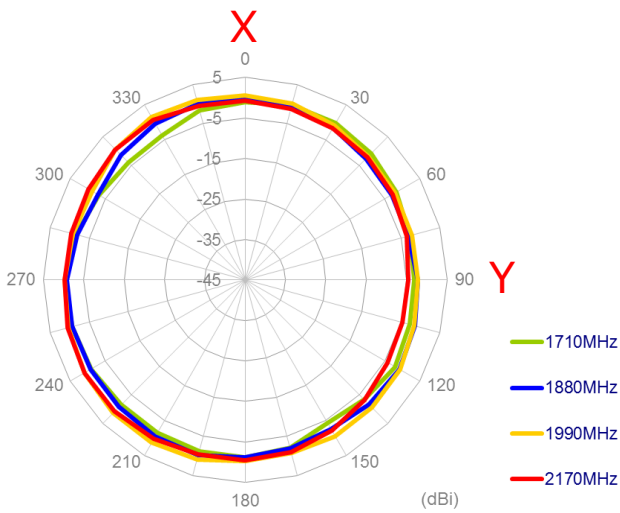
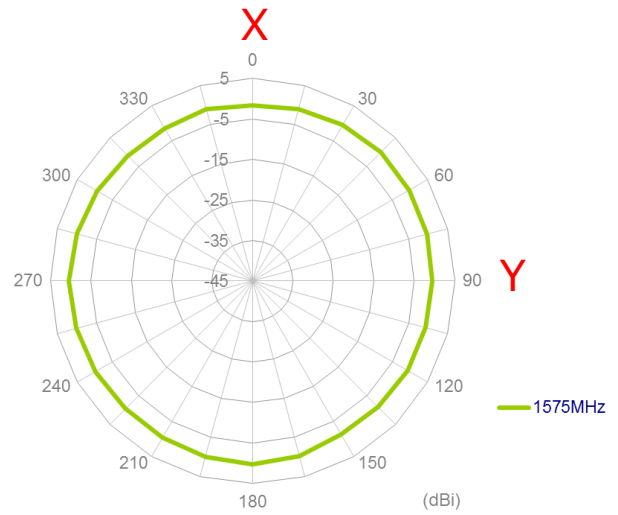
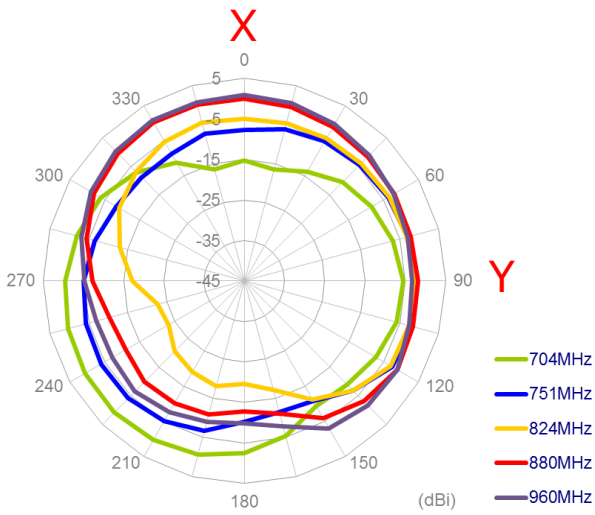

XZ Plane

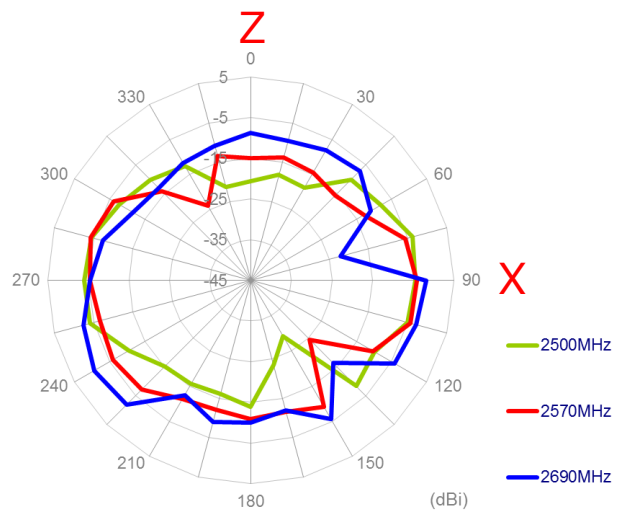
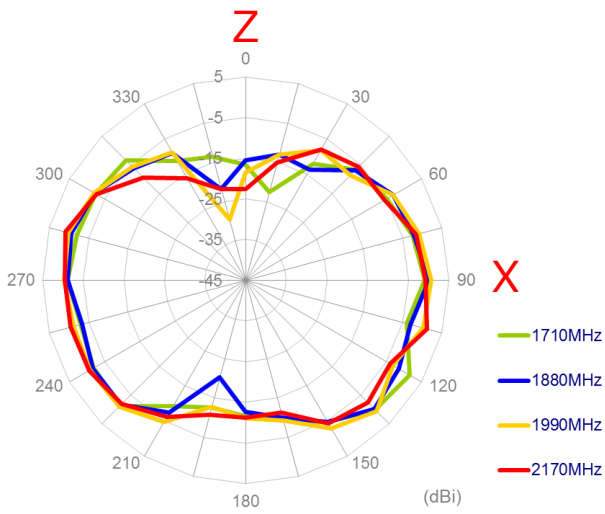
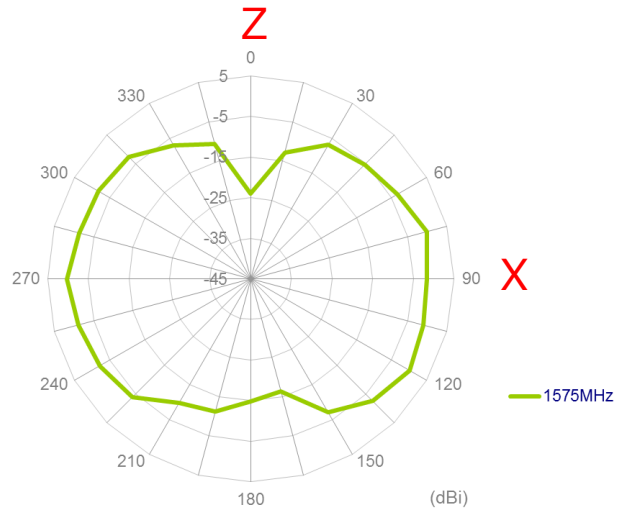
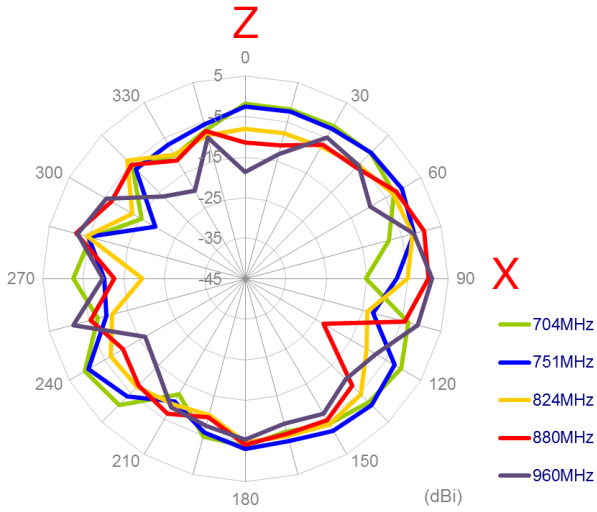

4.2. Antenna Setup (On Glass with 1 Meter Cable Length)

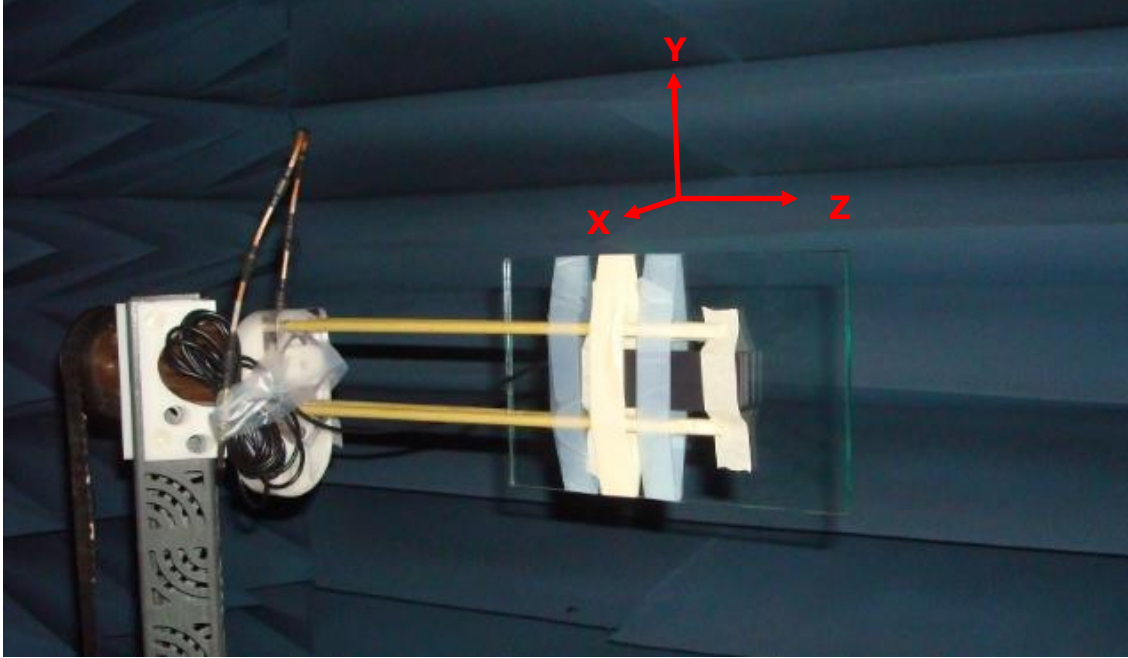

4.2.1. Radiation Patterns

XY Plane

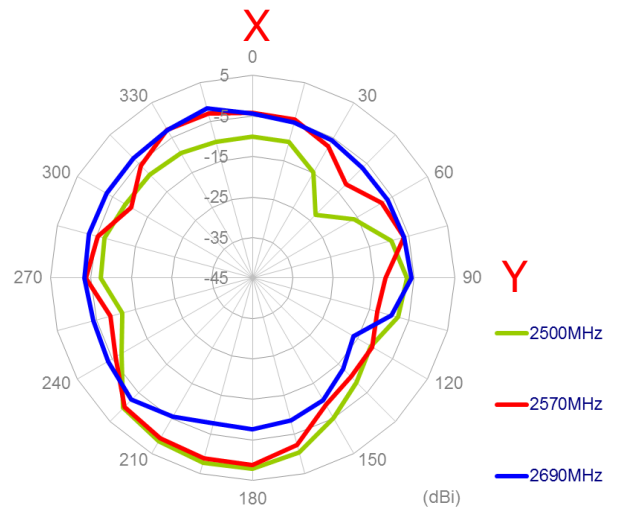
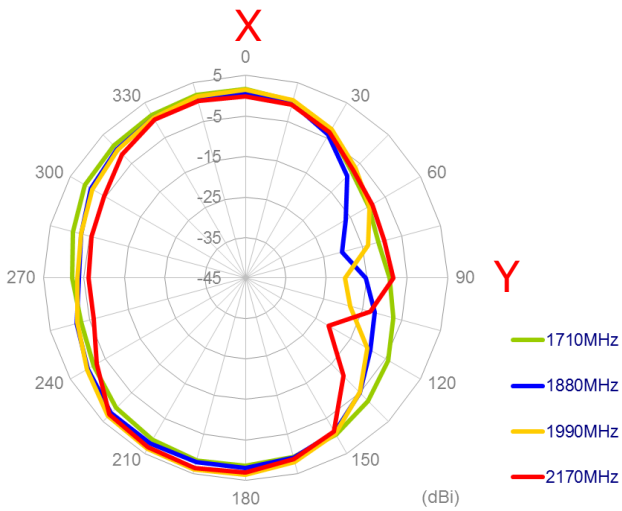
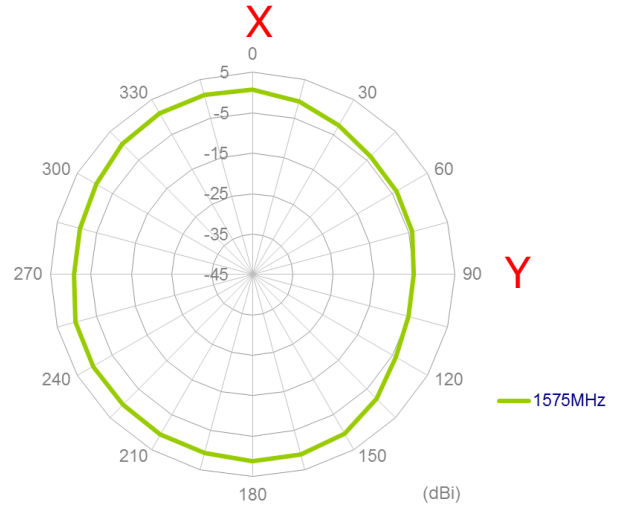
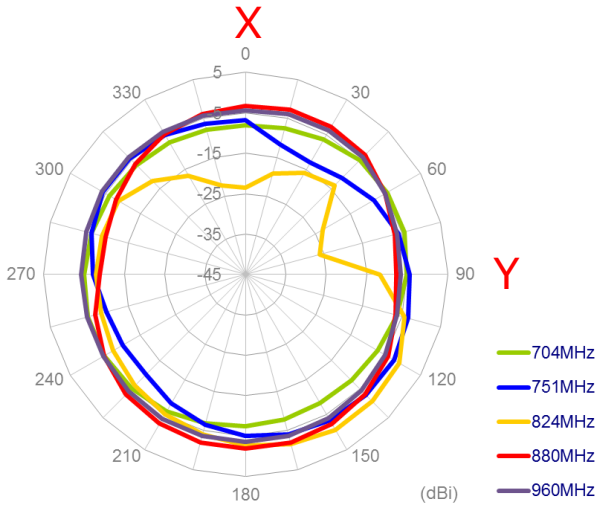

XZ Plane

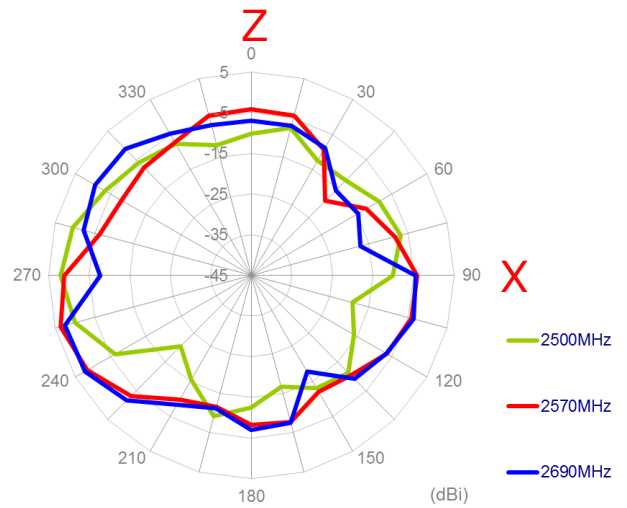
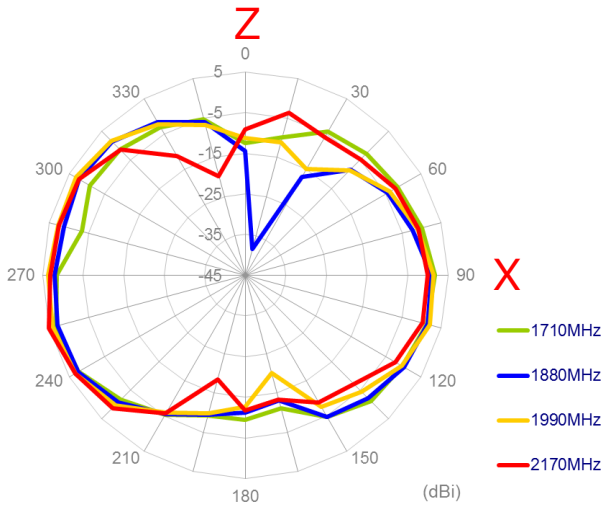
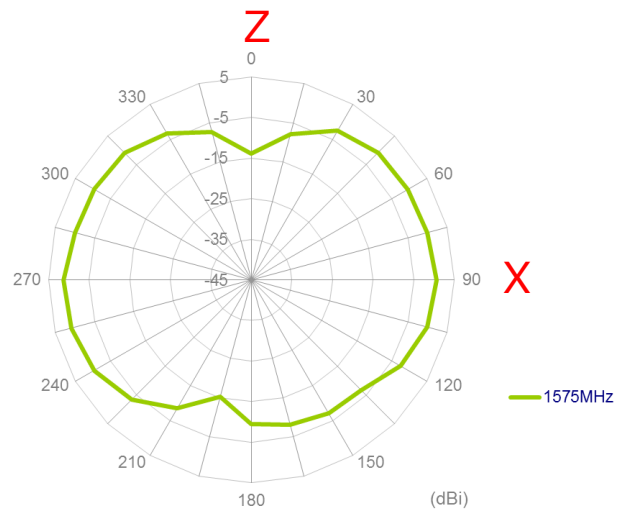
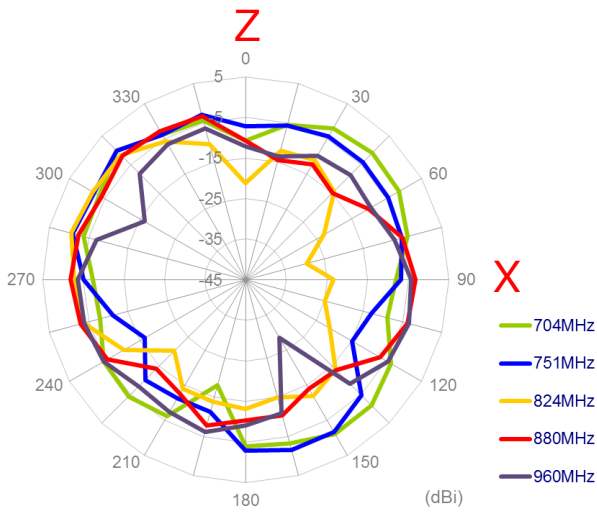

5. Mechanical Drawing (Unit: mm)

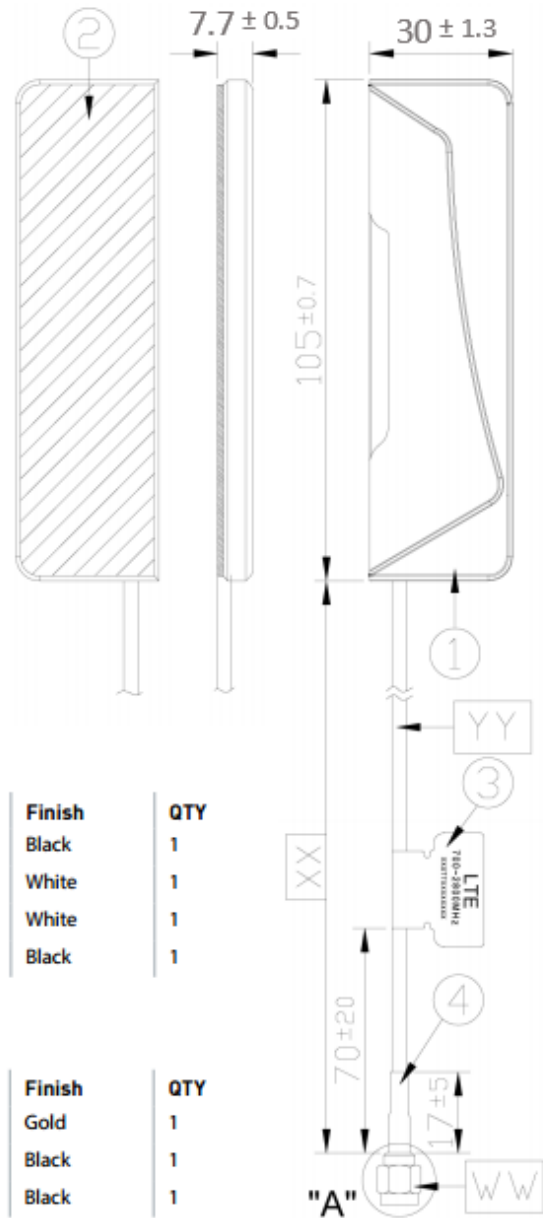
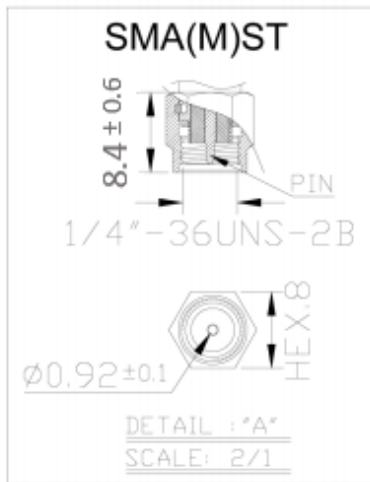

	Name	P/N	Material	Finish	QTY
1	Housing	000112G000015A	PC+ABS	Black	1
2	Double Sided Adhesive	001011J0000XXA	3M 1600T	White	1
3	LTE Label	001012G000015A	Coated Paper	White	1
4	Heat Shrink Tube	001311F0000XXA	PE	Black	1

	Name	P/N	Spec	Finish	QTY
WW	Connector Type	200212G000015A	SMA(M)ST	Gold	1
XX	Cable Length		1000±30mm	Black	1
YY	Cable Type	301313A0000XXA	RG174	Black	1

6. Packaging

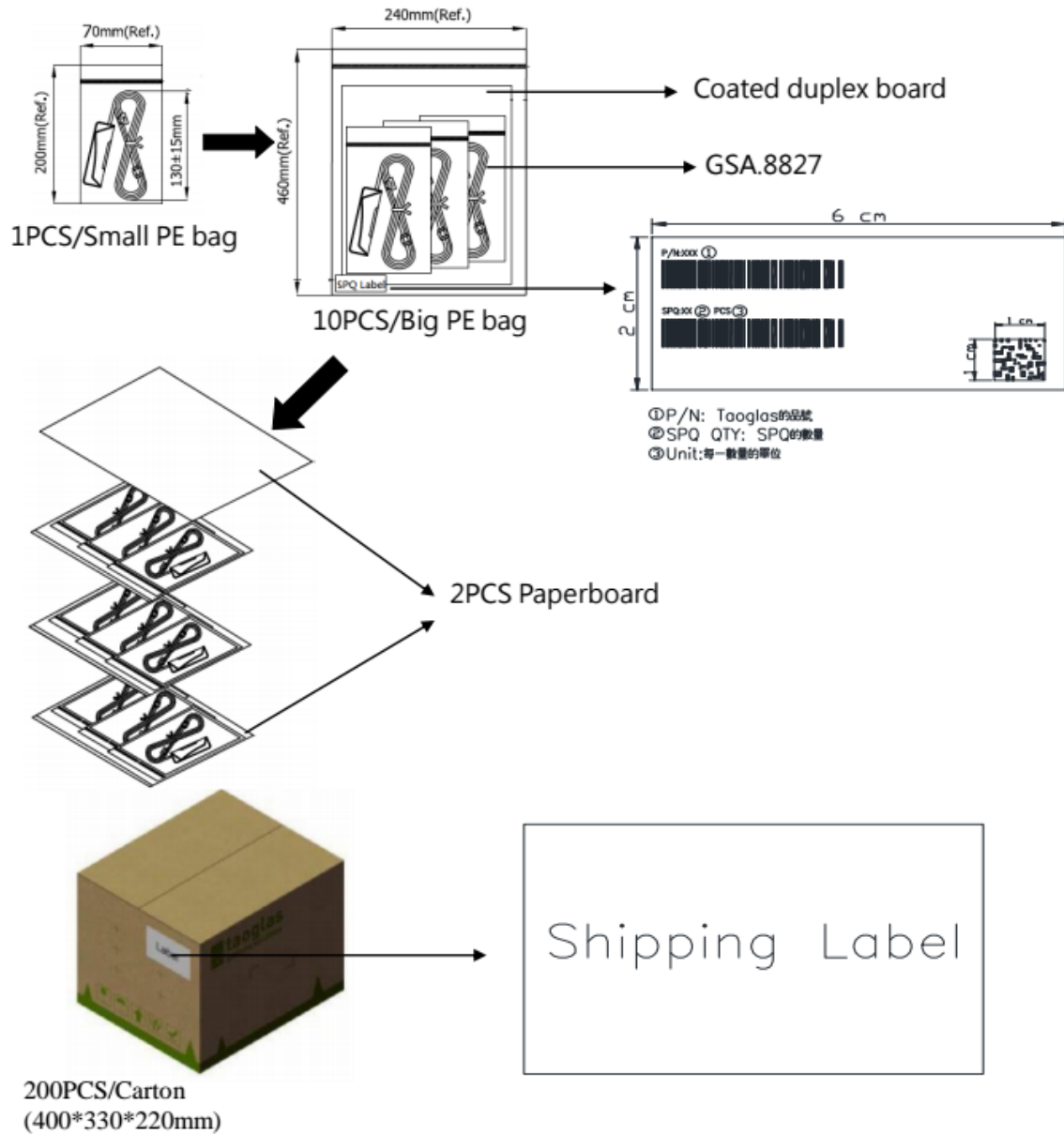

Taoglas makes no warranties based on the accuracy or completeness of the contents of this document and reserves the right to make changes to specifications and product descriptions at any time without notice. Taoglas reserves all rights to this document and the information contained herein.

Reproduction, use or disclosure to third parties without express permission is strictly prohibited.

Copyright © Taoglas Ltd.