

## 36V, Single-Supply, SOT553, Low-Power OPERATIONAL AMPLIFIERS Value Line Series

Check for Samples: [OPA170](#), [OPA2170](#), [OPA4170](#)

### FEATURES

- **Supply Range: +2.7V to +36V, ±1.35V to ±18V**
- **Low Noise: 19nV/√Hz**
- **RFI Filtered Inputs**
- **Input Range Includes the Negative Supply**
- **Input Range Operates to Positive Supply**
- **Rail-to-Rail Output**
- **Gain Bandwidth: 1.2MHz**
- **Low Quiescent Current: 110µA per Amplifier**
- **High Common-Mode Rejection: 120dB**
- **Low Bias Current: 15pA (max)**
- **Industry-Standard Packages:**
  - 8-Pin SOIC
  - 8-Pin MSOP
  - 14-Pin TSSOP
- **microPackages:**
  - Single in 5-Pin SOT553
  - Dual in 8-Pin VSSOP

### APPLICATIONS

- Tracking Amplifier in Power Modules
- Merchant Power Supplies
- Transducer Amplifiers
- Bridge Amplifiers
- Temperature Measurements
- Strain Gauge Amplifiers
- Precision Integrators
- Battery-Powered Instruments
- Test Equipment

Product Family

| DEVICE          | PACKAGE               |
|-----------------|-----------------------|
| OPA170 (single) | SOT553, SOT23-5, SO-8 |
| OPA2170 (dual)  | VSSOP-8, MSOP-8, SO-8 |
| OPA4170 (quad)  | TSSOP-14, SO-14       |

### DESCRIPTION

The OPA170, OPA2170 and OPA4170 (OPAx170) are a family of 36V, single-supply, low-noise operational amplifiers that feature micro packages with the ability to operate on supplies ranging from +2.7V (±1.35V) to +36V (±18V). They offer good offset, drift, and bandwidth with low quiescent current. The single, dual, and quad versions all have identical specifications for maximum design flexibility.

Unlike most op amps, which are specified at only one supply voltage, the OPAx170 family of op amps is specified from +2.7V to +36V. Input signals beyond the supply rails do not cause phase reversal. The OPAx170 family is stable with capacitive loads up to 300pF. The input can operate 100mV below the negative rail and within 2V of the positive rail for normal operation. Note that these devices can operate with full rail-to-rail input 100mV beyond the positive rail, but with reduced performance within 2V of the positive rail.

The OPA170 is available in SOT553, SOT23-5, and SO-8 packages. The dual OPA2170 comes in VSSOP-8, MSOP-8, and SO-8 packages. The quad OPA4170 is offered in TSSOP-14 and SO-14 packages. The OPAx170 op amps are specified from –40°C to +125°C.

Package Footprint Comparison (to Scale)

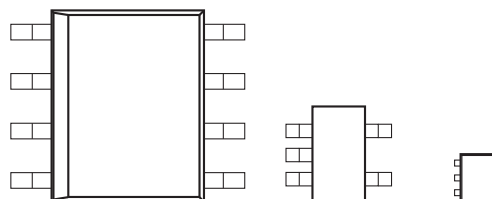

Package Height Comparison (to Scale)



D (SO-8)

DBV (SOT23-5)

DRL (SOT553)

### Smallest Packaging for 36V Op Amps



Please be aware that an important notice concerning availability, standard warranty, and use in critical applications of Texas Instruments semiconductor products and disclaimers thereto appears at the end of this data sheet.

All trademarks are the property of their respective owners.



This integrated circuit can be damaged by ESD. Texas Instruments recommends that all integrated circuits be handled with appropriate precautions. Failure to observe proper handling and installation procedures can cause damage.

ESD damage can range from subtle performance degradation to complete device failure. Precision integrated circuits may be more susceptible to damage because very small parametric changes could cause the device not to meet its published specifications.

### PACKAGE/ORDERING INFORMATION<sup>(1)</sup>

| PRODUCT | PACKAGE-LEAD | PACKAGE DESIGNATOR | PACKAGE MARKING | ORDERING NUMBER | TRANSPORT MEDIA, QUANTITY |
|---------|--------------|--------------------|-----------------|-----------------|---------------------------|
| OPA170  | SOT553-5     | DRL                | DAQ             | OPA170AIDRLT    | Tape and Reel, 250        |
|         |              |                    |                 | OPA170AIDRLR    | Tape and Reel, 4000       |
|         | SOT23-5      | DBV                | OSVI            | OPA170AIDBVT    | Tape and Reel, 250        |
|         |              |                    |                 | OPA170AIDBVR    | Tape and Reel, 3000       |
|         | SO-8         | D                  | O170A           | OPA170AID       | Rail, 75                  |
|         |              |                    |                 | OPA170AIDR      | Tape and Reel, 2500       |
| OPA2170 | MSOP-8       | DGK                | OPNI            | OPA2170AIDGK    | Rail, 80                  |
|         |              |                    |                 | OPA2170AIDGKR   | Tape and Reel, 2500       |
|         | VSSOP-8      | DCU                | OPQC            | OPA2170AIDCUT   | Tape and Reel, 250        |
|         |              |                    |                 | OPA2170AIDCUR   | Tape and Reel, 3000       |
|         | SO-8         | D                  | 2170A           | OPA2170AID      | Rail, 75                  |
|         |              |                    |                 | OPA2170AIDR     | Tape and Reel, 2500       |
| OPA4170 | SO-14        | D                  | OPA4170         | OPA4170AID      | Rail, 50                  |
|         |              |                    |                 | OPA4170AIDR     | Tape and Reel, 2500       |
|         | TSSOP-14     | PW                 | OPA4170         | OPA4170AIPW     | Rail, 90                  |
|         |              |                    |                 | OPA4170AIPWR    | Tape and Reel, 2000       |

(1) For the most current package and ordering information, see the Package Option Addendum at the end of this document, or visit the device product folder at [www.ti.com](http://www.ti.com).

### ABSOLUTE MAXIMUM RATINGS<sup>(1)</sup>

Over operating free-air temperature range, unless otherwise noted.

|                                     |                            | OPA170, OPA2170, OPA4170                           | UNIT |
|-------------------------------------|----------------------------|--|------|
| Supply voltage                      |                            | ±20, +40 (single supply)                           | V    |
| Signal input terminals              | Voltage                    | (V <sub>-</sub> ) – 0.5 to (V <sub>+</sub> ) + 0.5 | V    |
|                                     | Current                    | ±10  | mA   |
| Output short circuit <sup>(2)</sup> |                            | Continuous   |      |
| Operating temperature               |                            | –55 to +150  | °C   |
| Storage temperature                 |                            | –65 to +150  | °C   |
| Junction temperature                |                            | +150   | °C   |
| ESD ratings                         | Human body model (HBM)     | 4  | kV   |
|                                     | Charged device model (CDM) | 750  | V    |

(1) Stresses above these ratings may cause permanent damage. Exposure to absolute maximum conditions for extended periods may degrade device reliability. These are stress ratings only, and functional operation of the device at these or any other conditions beyond those specified is not implied.

(2) Short-circuit to ground, one amplifier per package.

## ELECTRICAL CHARACTERISTICS

**Boldface** limits apply over the specified temperature range,  $T_A = -40^{\circ}\text{C}$  to  $+125^{\circ}\text{C}$ .

At  $T_A = +25^{\circ}\text{C}$ ,  $V_{CM} = V_{OUT} = V_S/2$ , and  $R_L = 10\text{k}\Omega$  connected to  $V_S/2$ , unless otherwise noted.

| PARAMETER                                | TEST CONDITIONS            | OPA170, OPA2170, OPA4170  |   |                                 | UNIT   |
|--|----------------------------|---|---|---------------------------------|--|
|  |                            | MIN   | TYP   | MAX                             |  |
| <b>OFFSET VOLTAGE</b>                    |                            |   |   |                                 |  |
| Input offset voltage                     | $V_{OS}$                   |   | 0.25  | $\pm 1.8$                       | mV   |
| <b>Over temperature</b>                  |                            |   |   | <b><math>\pm 2</math></b>       | <b>mV</b>  |
| <b>Drift</b>                             | $dV_{OS}/dT$               |   | <b><math>\pm 0.3</math></b>                 | <b><math>\pm 2</math></b>       | <b><math>\mu\text{V}/^{\circ}\text{C}</math></b> |
| <b>vs power supply</b>                   | <b>PSRR</b>                | <b><math>V_S = +4\text{V}</math> to <b><math>+36\text{V}</math></b></b>   | <b>1</b>                                    | <b><math>\pm 5</math></b>       | <b><math>\mu\text{V}/\text{V}</math></b>         |
| Channel separation, dc                   | dc                         |   | 5   |                                 | $\mu\text{V}/\text{V}$                           |
| <b>INPUT BIAS CURRENT</b>                |                            |   |   |                                 |  |
| Input bias current                       | $I_B$                      |   | $\pm 8$                                     | $\pm 15$                        | pA   |
| <b>Over temperature</b>                  |                            |   |   | <b><math>\pm 3.5</math></b>     | <b>nA</b>  |
| Input offset current                     | $I_{OS}$                   |   | $\pm 4$                                     | $\pm 15$                        | pA   |
| <b>Over temperature</b>                  |                            |   |   | <b><math>\pm 3.5</math></b>     | <b>nA</b>  |
| <b>NOISE</b>                             |                            |   |   |                                 |  |
| Input voltage noise                      |                            | $f = 0.1\text{Hz}$ to $10\text{Hz}$   | 2   |                                 | $\mu\text{V}_{PP}$                               |
| Input voltage noise density              | $e_n$                      | $f = 100\text{Hz}$  | 22  |                                 | $\text{nV}/\sqrt{\text{Hz}}$                     |
|  |                            | $f = 1\text{kHz}$   | 19  |                                 | $\text{nV}/\sqrt{\text{Hz}}$                     |
| <b>INPUT VOLTAGE</b>                     |                            |   |   |                                 |  |
| Common-mode voltage range <sup>(1)</sup> | $V_{CM}$                   |   | $(V-) - 0.1\text{V}$                        | $(V+) - 2\text{V}$              | V  |
| <b>Common-mode rejection ratio</b>       | <b>CMRR</b>                | <b><math>V_S = \pm 2\text{V}</math>, <math>(V-) - 0.1\text{V} &lt; V_{CM} &lt; (V+) - 2\text{V}</math></b>                                  | <b>90</b>                                   | <b>104</b>                      | <b>dB</b>  |
|  |                            | <b><math>V_S = \pm 18\text{V}</math>, <math>(V-) - 0.1\text{V} &lt; V_{CM} &lt; (V+) - 2\text{V}</math></b>                                 | <b>104</b>                                  | <b>120</b>                      | <b>dB</b>  |
| <b>INPUT IMPEDANCE</b>                   |                            |   |   |                                 |  |
| Differential                             |                            |   | $100 \parallel 3$                           |                                 | $\text{M}\Omega \parallel \text{pF}$             |
| Common-mode                              |                            |   | $6 \parallel 3$                             |                                 | $10^{12} \Omega \parallel \text{pF}$             |
| <b>OPEN-LOOP GAIN</b>                    |                            |   |   |                                 |  |
| <b>Open-loop voltage gain</b>            | <b><math>A_{OL}</math></b> | <b><math>V_S = +4\text{V}</math> to <b><math>+36\text{V}</math>, <math>(V-) + 0.35\text{V} &lt; V_O &lt; (V+) - 0.35\text{V}</math></b></b> | <b>110</b>                                  | <b>130</b>                      | <b>dB</b>  |
| <b>FREQUENCY RESPONSE</b>                |                            |   |   |                                 |  |
| Gain bandwidth product                   | GBP                        |   | 1.2   |                                 | MHz  |
| Slew rate                                | SR                         | $G = +1$  | 0.4   |                                 | $\text{V}/\mu\text{s}$                           |
| Settling time                            | $t_S$                      | To 0.1%, $V_S = \pm 18\text{V}$ , $G = +1$ , 10V step   | 20  |                                 | $\mu\text{s}$                                    |
|  |                            | To 0.01% (12 bit), $V_S = \pm 18\text{V}$ , $G = +1$ , 10V step   | 28  |                                 | $\mu\text{s}$                                    |
| Overload recovery time                   |                            | $V_{IN} \times \text{Gain} > V_S$   | 2   |                                 | $\mu\text{s}$                                    |
| Total harmonic distortion + noise        | THD+N                      | $G = +1$ , $f = 1\text{kHz}$ , $V_O = 3V_{RMS}$   | 0.0002                                      |                                 | %  |
| <b>OUTPUT</b>                            |                            |   |   |                                 |  |
| <b>Voltage output swing from rail</b>    | <b><math>V_O</math></b>    |   |   |                                 |  |
| Positive rail                            |                            | $I_L = 0\text{mA}$ , $V_S = +4\text{V}$ to $+36\text{V}$  | 10  |                                 | mV   |
|  |                            | $I_L$ sourcing 1mA, $V_S = +4\text{V}$ to $+36\text{V}$   | 115   |                                 | mV   |
| Negative Rail                            |                            | $I_L = 0\text{mA}$ , $V_S = +4\text{V}$ to $+36\text{V}$  |   | 8                               | mV   |
|  |                            | $I_L$ sinking 1mA, $V_S = +4\text{V}$ to $+36\text{V}$  |   | 70                              | mV   |
| <b>Over temperature</b>                  |                            | <b><math>V_S = 5\text{V}</math>, <math>R_L = 10\text{k}\Omega</math></b>  | <b><math>(V-) + 0.03</math></b>             | <b><math>(V+) - 0.05</math></b> | <b>V</b>   |
|  |                            | <b><math>R_L = 10\text{k}\Omega</math>, <math>A_{OL} \geq 110\text{dB}</math></b>   | <b><math>(V-) + 0.35</math></b>             | <b><math>(V+) - 0.35</math></b> | <b>V</b>   |
| Short-circuit current                    | $I_{SC}$                   |   | $+17/-20$                                   |                                 | mA   |
| Capacitive load drive                    | $C_{LOAD}$                 |   | See <a href="#">Typical Characteristics</a> |                                 | pF   |
| Open-loop output resistance              | $R_O$                      | $f = 1\text{MHz}$ , $I_O = 0\text{A}$   | 900   |                                 | $\Omega$   |
| <b>POWER SUPPLY</b>                      |                            |   |   |                                 |  |
| Specified voltage range                  | $V_S$                      |   | +2.7  | +36                             | V  |
| Quiescent current per amplifier          | $I_Q$                      | $I_O = 0\text{A}$   | 110   | 145                             | $\mu\text{A}$                                    |
| <b>Over temperature</b>                  |                            | <b><math>I_O = 0\text{A}</math></b>   |   | <b>155</b>                      | <b><math>\mu\text{A}</math></b>                  |

(1) The input range can be extended beyond  $(V+) - 2\text{V}$  up to  $V+$ . See the [Typical Characteristics](#) and [Application Information](#) sections for additional information.

## ELECTRICAL CHARACTERISTICS (continued)

**Boldface** limits apply over the specified temperature range,  $T_A = -40^{\circ}\text{C}$  to  $+125^{\circ}\text{C}$ .

At  $T_A = +25^{\circ}\text{C}$ ,  $V_{CM} = V_{OUT} = V_S/2$ , and  $R_L = 10\text{k}\Omega$  connected to  $V_S/2$ , unless otherwise noted.

| PARAMETER          | TEST CONDITIONS | OPA170, OPA2170, OPA4170 |     |      | UNIT               |
|--------------------|-----------------|--------------------------|-----|------|--------------------|
|                    |                 | MIN                      | TYP | MAX  |                    |
| <b>TEMPERATURE</b> |                 |                          |     |      |                    |
| Specified range    |                 | -40                      |     | +125 | $^{\circ}\text{C}$ |
| Operating range    |                 | -55                      |     | +150 | $^{\circ}\text{C}$ |

### THERMAL INFORMATION: OPA170

| THERMAL METRIC <sup>(1)</sup> |  | OPA170        |               |               | UNITS                       |
|-------------------------------|--|---------------|---------------|---------------|-----------------------------|
|                               |  | D (SO)        | DBV (SOT23)   | DRL (SOT553)  |                             |
|                               |  | <b>8 PINS</b> | <b>5 PINS</b> | <b>5 PINS</b> |                             |
| $\theta_{JA}$                 | Junction-to-ambient thermal resistance       | 149.5         | 245.8         | 208.1         | $^{\circ}\text{C}/\text{W}$ |
| $\theta_{JC(\text{top})}$     | Junction-to-case(top) thermal resistance     | 97.9          | 133.9         | 0.1           |                             |
| $\theta_{JB}$                 | Junction-to-board thermal resistance         | 87.7          | 83.6          | 42.4          |                             |
| $\Psi_{JT}$                   | Junction-to-top characterization parameter   | 35.5          | 18.2          | 0.5           |                             |
| $\Psi_{JB}$                   | Junction-to-board characterization parameter | 89.5          | 83.1          | 42.2          |                             |
| $\theta_{JC(\text{bottom})}$  | Junction-to-case(bottom) thermal resistance  | N/A           | N/A           | N/A           |                             |

(1) For more information about traditional and new thermal metrics, see the *IC Package Thermal Metrics* application report, [SPRA953](#).

### THERMAL INFORMATION: OPA2170

| THERMAL METRIC <sup>(1)</sup> |  | OPA2170       |               |               | UNITS                       |
|-------------------------------|--|---------------|---------------|---------------|-----------------------------|
|                               |  | D (SO)        | DCU (VSSOP)   | DGK (MSOP)    |                             |
|                               |  | <b>8 PINS</b> | <b>8 PINS</b> | <b>8 PINS</b> |                             |
| $\theta_{JA}$                 | Junction-to-ambient thermal resistance       | 134.3         | 175.2         | 180           | $^{\circ}\text{C}/\text{W}$ |
| $\theta_{JC(\text{top})}$     | Junction-to-case(top) thermal resistance     | 72.1          | 74.9          | 55            |                             |
| $\theta_{JB}$                 | Junction-to-board thermal resistance         | 60.6          | 22.2          | 130           |                             |
| $\Psi_{JT}$                   | Junction-to-top characterization parameter   | 18.2          | 1.6           | 5.3           |                             |
| $\Psi_{JB}$                   | Junction-to-board characterization parameter | 53.8          | 22.8          | 120           |                             |
| $\theta_{JC(\text{bottom})}$  | Junction-to-case(bottom) thermal resistance  | N/A           | N/A           | N/A           |                             |

(1) For more information about traditional and new thermal metrics, see the *IC Package Thermal Metrics* application report, [SPRA953](#).

### THERMAL INFORMATION: OPA4170

| THERMAL METRIC <sup>(1)</sup> |  | OPA4170        |                | UNITS                       |
|-------------------------------|--|----------------|----------------|-----------------------------|
|                               |  | D (SO)         | PW (TSSOP)     |                             |
|                               |  | <b>14 PINS</b> | <b>14 PINS</b> |                             |
| $\theta_{JA}$                 | Junction-to-ambient thermal resistance       | 93.2           | 106.9          | $^{\circ}\text{C}/\text{W}$ |
| $\theta_{JC(\text{top})}$     | Junction-to-case(top) thermal resistance     | 51.8           | 24.4           |                             |
| $\theta_{JB}$                 | Junction-to-board thermal resistance         | 49.4           | 59.3           |                             |
| $\Psi_{JT}$                   | Junction-to-top characterization parameter   | 13.5           | 0.6            |                             |
| $\Psi_{JB}$                   | Junction-to-board characterization parameter | 42.2           | 54.3           |                             |
| $\theta_{JC(\text{bottom})}$  | Junction-to-case(bottom) thermal resistance  | N/A            | N/A            |                             |

(1) For more information about traditional and new thermal metrics, see the *IC Package Thermal Metrics* application report, [SPRA953](#).

**PIN CONFIGURATIONS**

**DRL PACKAGE: OPA170  
SOT-553  
(TOP VIEW)**

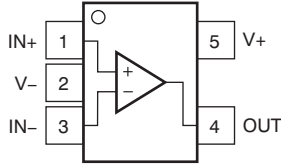

**DBV PACKAGE: OPA170  
SOT23-5  
(TOP VIEW)**

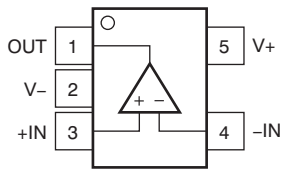

**D PACKAGE: OPA170  
SO-8  
(TOP VIEW)**

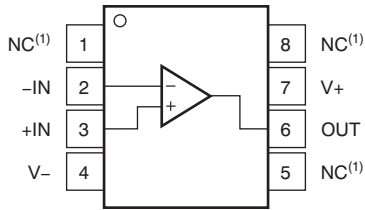

**D, DGK, AND DCU PACKAGES: OPA2170  
MSOP-8, SO-8, AND VSSOP-8  
(TOP VIEW)**

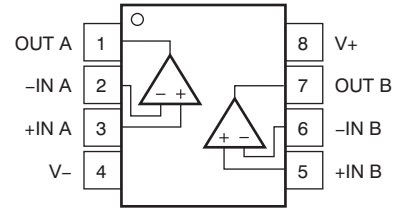

**D AND PW PACKAGES: OPA4170  
SO-14 AND TSSOP-14  
(TOP VIEW)**

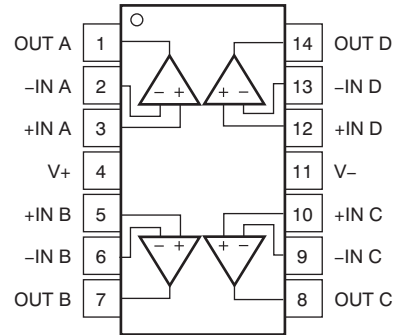

(1) No internal connection.

## TYPICAL CHARACTERISTICS

**Table 1. Characteristic Performance Measurements**

| DESCRIPTION   | FIGURE  |
|---|---|
| Offset Voltage Production Distribution                        | <a href="#">Figure 1</a>                              |
| Offset Voltage Drift Distribution                             | <a href="#">Figure 2</a>                              |
| Offset Voltage vs Temperature                                 | <a href="#">Figure 3</a>                              |
| Offset Voltage vs Common-Mode Voltage                         | <a href="#">Figure 4</a>                              |
| Offset Voltage vs Common-Mode Voltage (Upper Stage)           | <a href="#">Figure 5</a>                              |
| Offset Voltage vs Power Supply                                | <a href="#">Figure 6</a>                              |
| $I_B$ and $I_{OS}$ vs Common-Mode Voltage                     | <a href="#">Figure 7</a>                              |
| Input Bias Current vs Temperature                             | <a href="#">Figure 8</a>                              |
| Output Voltage Swing vs Output Current (Maximum Supply)       | <a href="#">Figure 9</a>                              |
| CMRR and PSRR vs Frequency (Referred-to Input)                | <a href="#">Figure 10</a>                             |
| CMRR vs Temperature   | <a href="#">Figure 11</a>                             |
| PSRR vs Temperature   | <a href="#">Figure 12</a>                             |
| 0.1Hz to 10Hz Noise   | <a href="#">Figure 13</a>                             |
| Input Voltage Noise Spectral Density vs Frequency             | <a href="#">Figure 14</a>                             |
| THD+N Ratio vs Frequency                                      | <a href="#">Figure 15</a>                             |
| THD+N vs Output Amplitude                                     | <a href="#">Figure 16</a>                             |
| Quiescent Current vs Temperature                              | <a href="#">Figure 17</a>                             |
| Quiescent Current vs Supply Voltage                           | <a href="#">Figure 18</a>                             |
| Open-Loop Gain and Phase vs Frequency                         | <a href="#">Figure 19</a>                             |
| Closed-Loop Gain vs Frequency                                 | <a href="#">Figure 20</a>                             |
| Open-Loop Gain vs Temperature                                 | <a href="#">Figure 21</a>                             |
| Open-Loop Output Impedance vs Frequency                       | <a href="#">Figure 22</a>                             |
| Small-Signal Overshoot vs Capacitive Load (100mV Output Step) | <a href="#">Figure 23</a> , <a href="#">Figure 24</a> |
| No Phase Reversal   | <a href="#">Figure 25</a>                             |
| Positive Overload Recovery                                    | <a href="#">Figure 26</a>                             |
| Negative Overload Recovery                                    | <a href="#">Figure 27</a>                             |
| Small-Signal Step Response (100mV)                            | <a href="#">Figure 28</a> , <a href="#">Figure 29</a> |
| Large-Signal Step Response                                    | <a href="#">Figure 30</a> , <a href="#">Figure 31</a> |
| Large-Signal Settling Time (10V Positive Step)                | <a href="#">Figure 32</a>                             |
| Large-Signal Settling Time (10V Negative Step)                | <a href="#">Figure 33</a>                             |
| Short-Circuit Current vs Temperature                          | <a href="#">Figure 34</a>                             |
| Maximum Output Voltage vs Frequency                           | <a href="#">Figure 35</a>                             |
| EMIRR IN+ vs Frequency  | <a href="#">Figure 36</a>                             |

### TYPICAL CHARACTERISTICS

$V_S = \pm 18V$ ,  $V_{CM} = V_S/2$ ,  $R_{LOAD} = 10k\Omega$  connected to  $V_S/2$ , and  $C_L = 100pF$ , unless otherwise noted.

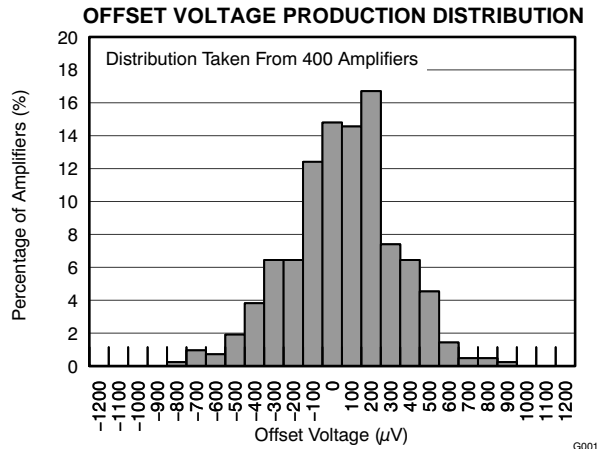

Figure 1.

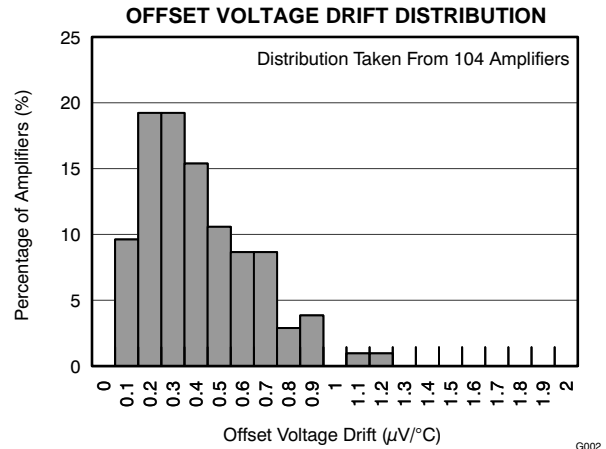

Figure 2.

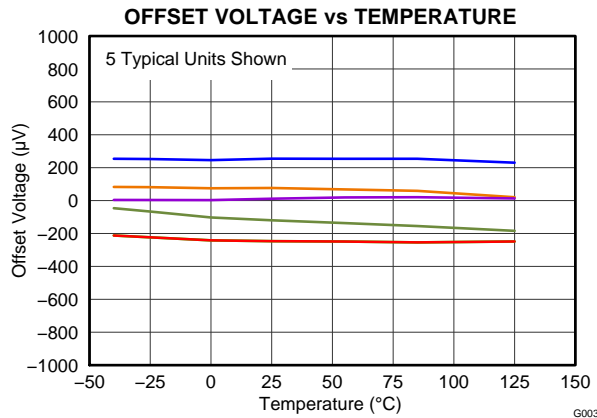

Figure 3.

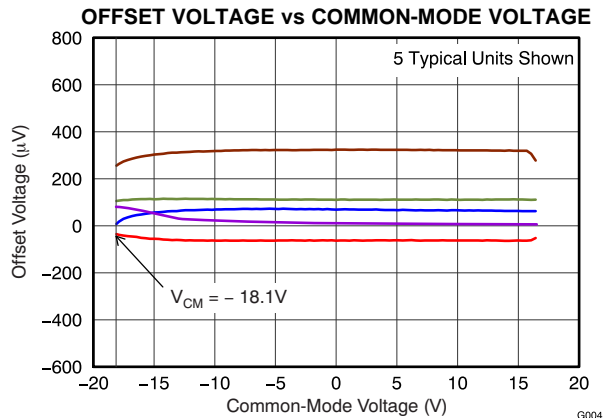

Figure 4.

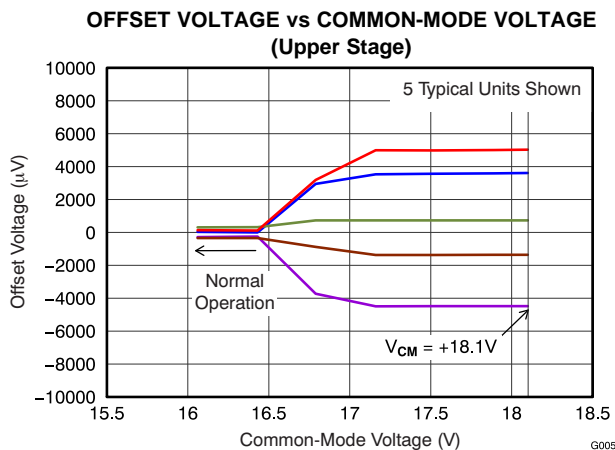

Figure 5.

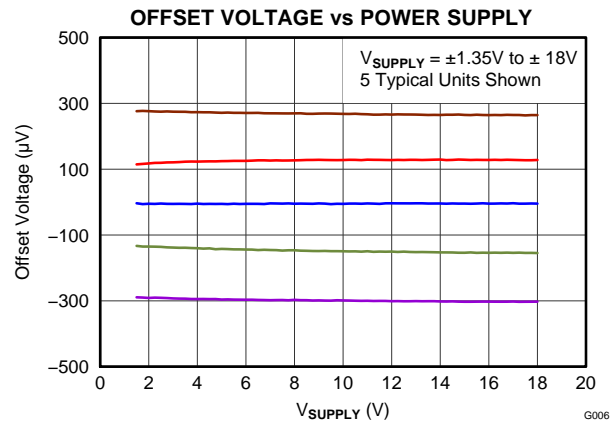

Figure 6.

**TYPICAL CHARACTERISTICS (continued)**

$V_S = \pm 18V$ ,  $V_{CM} = V_S/2$ ,  $R_{LOAD} = 10k\Omega$  connected to  $V_S/2$ , and  $C_L = 100pF$ , unless otherwise noted.

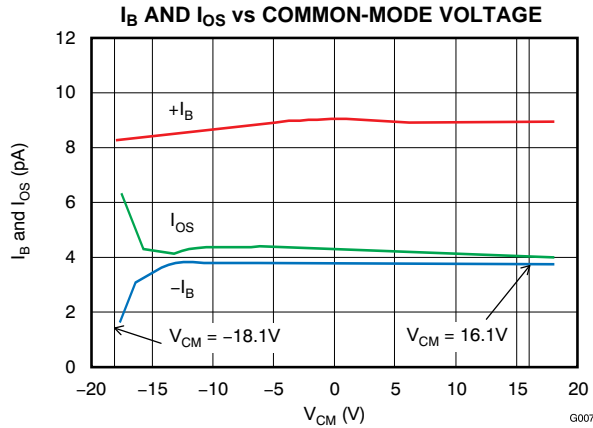

Figure 7.

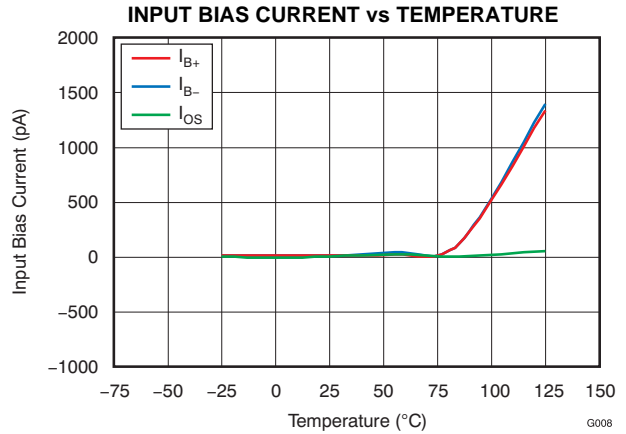

Figure 8.

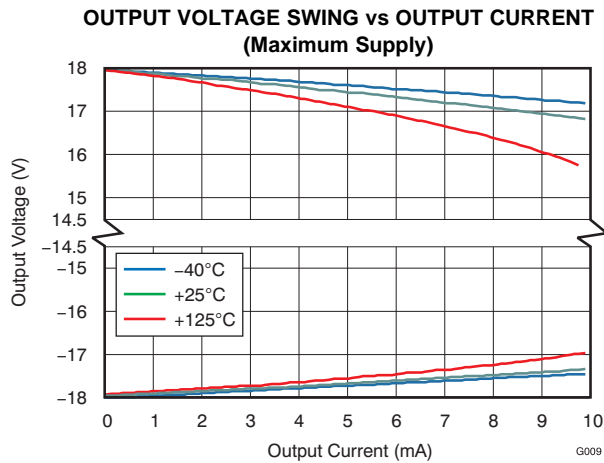

Figure 9.

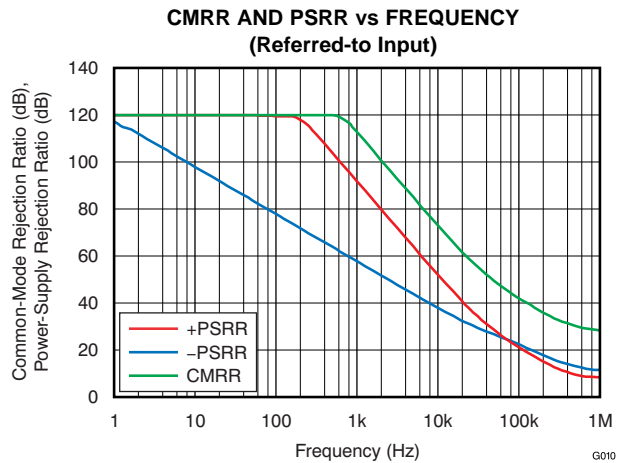

Figure 10.

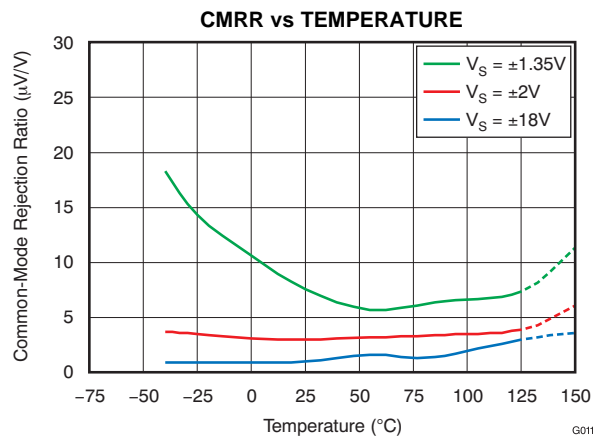

Figure 11.

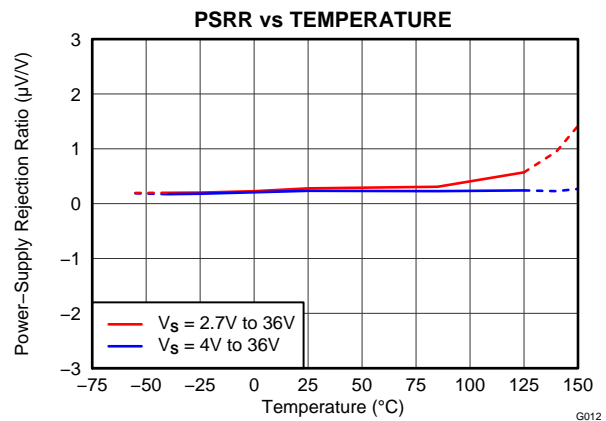

Figure 12.



**TYPICAL CHARACTERISTICS (continued)**

$V_S = \pm 18V$ ,  $V_{CM} = V_S/2$ ,  $R_{LOAD} = 10k\Omega$  connected to  $V_S/2$ , and  $C_L = 100pF$ , unless otherwise noted.

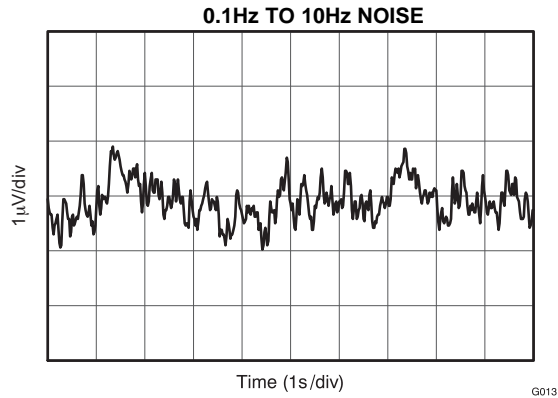

Figure 13.

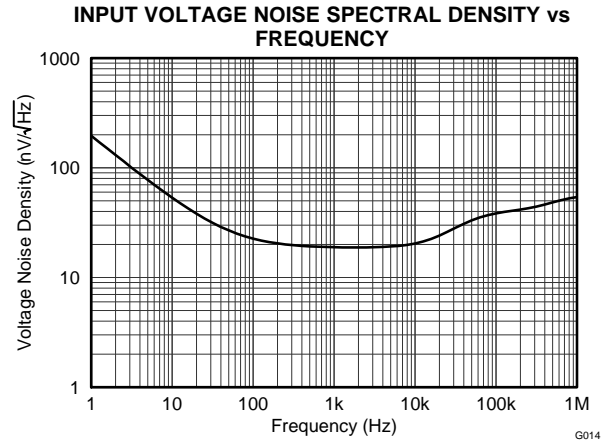

Figure 14.

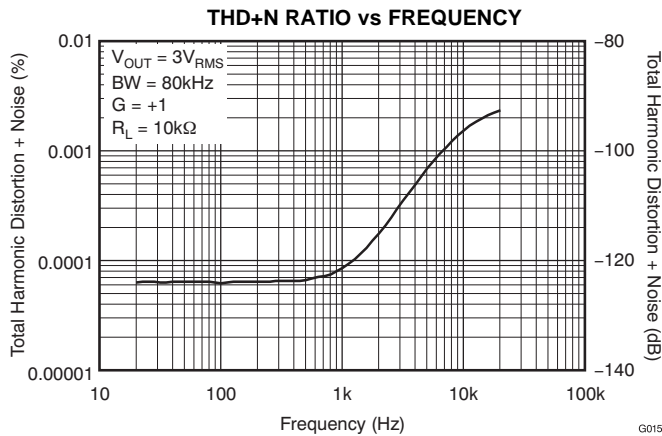

Figure 15.

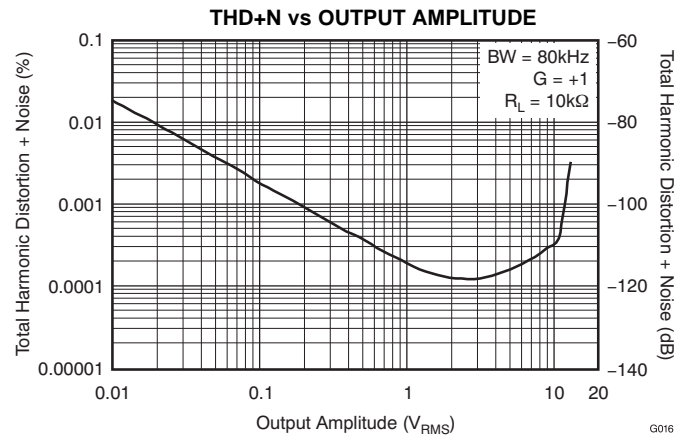

Figure 16.

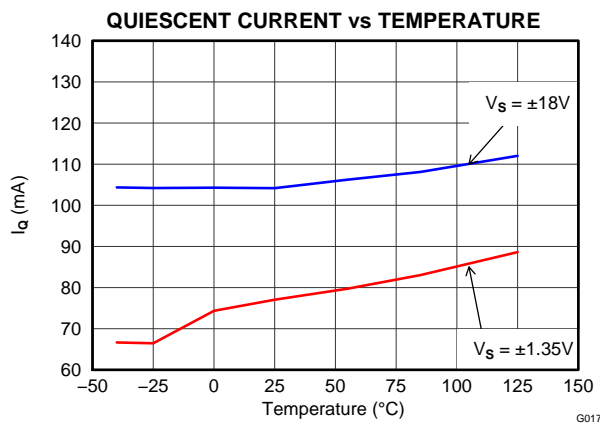

Figure 17.

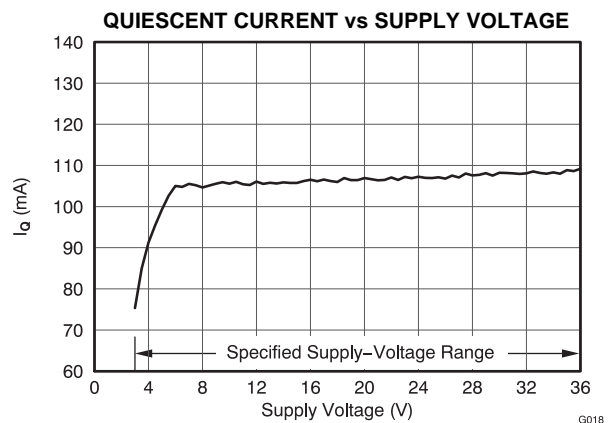

Figure 18.

**TYPICAL CHARACTERISTICS (continued)**

$V_S = \pm 18V$ ,  $V_{CM} = V_S/2$ ,  $R_{LOAD} = 10k\Omega$  connected to  $V_S/2$ , and  $C_L = 100pF$ , unless otherwise noted.

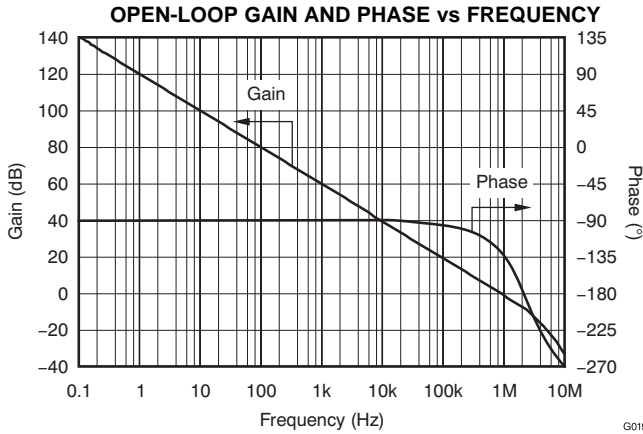

Figure 19.

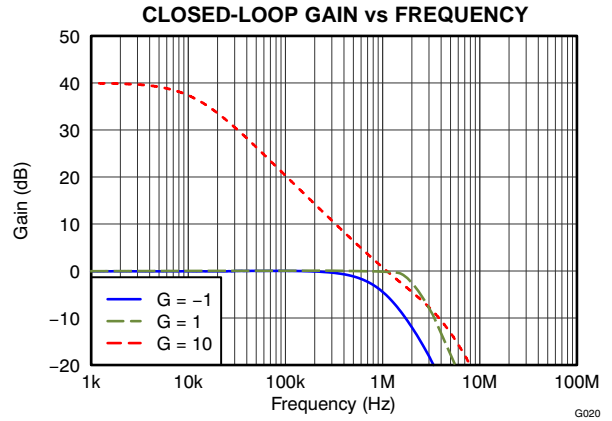

Figure 20.

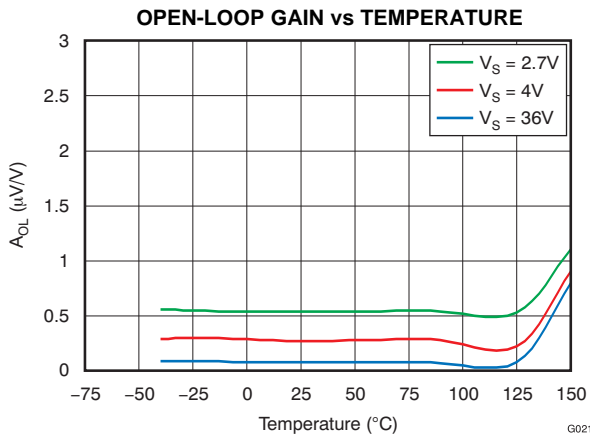

Figure 21.

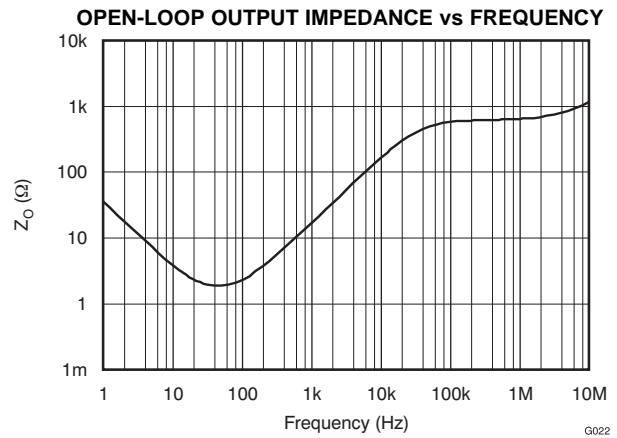

Figure 22.

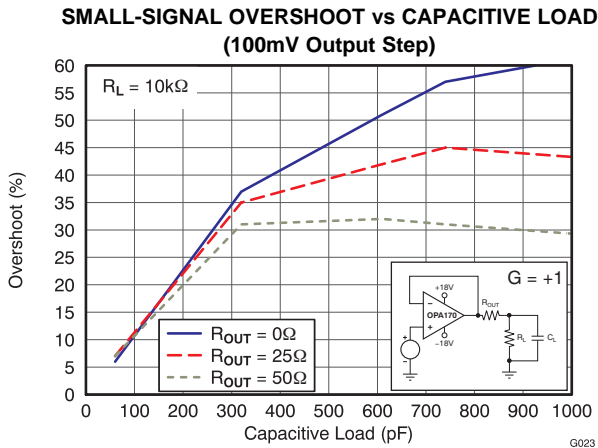

Figure 23.

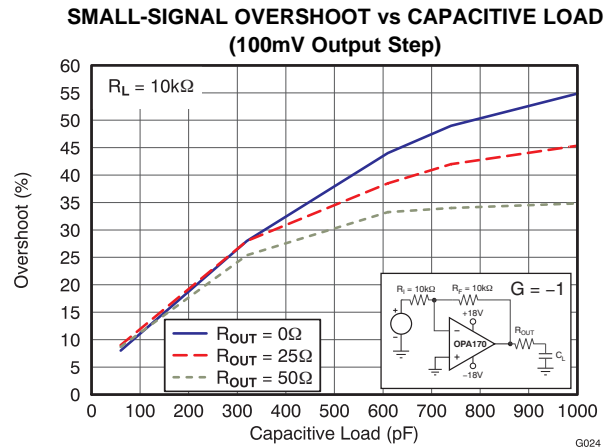

Figure 24.

**TYPICAL CHARACTERISTICS (continued)**

$V_S = \pm 18V$ ,  $V_{CM} = V_S/2$ ,  $R_{LOAD} = 10k\Omega$  connected to  $V_S/2$ , and  $C_L = 100pF$ , unless otherwise noted.

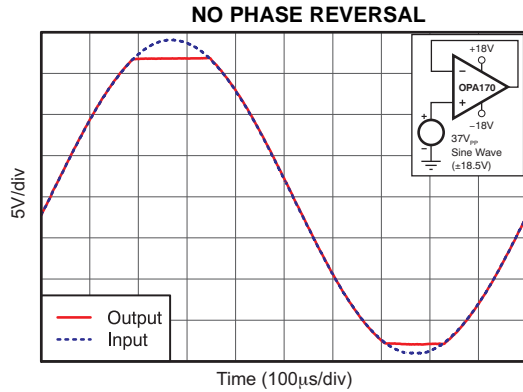

Figure 25.

G025

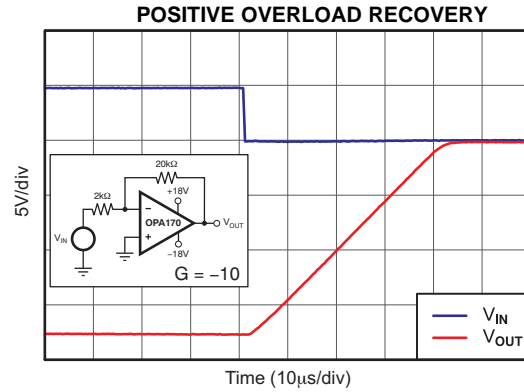

Figure 26.

G026

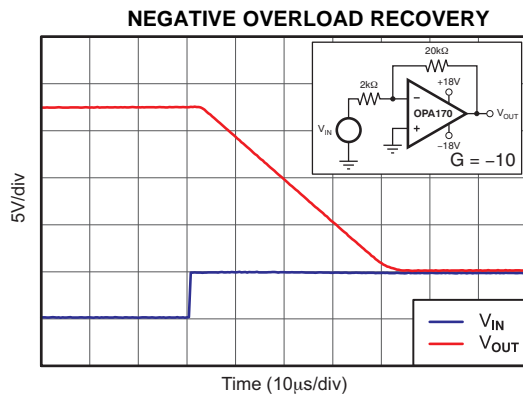

Figure 27.

G027

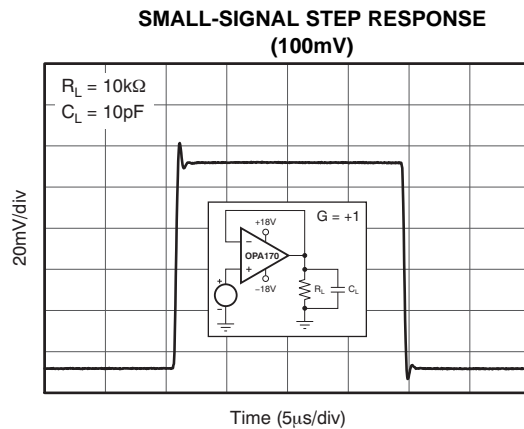

Figure 28.

G028

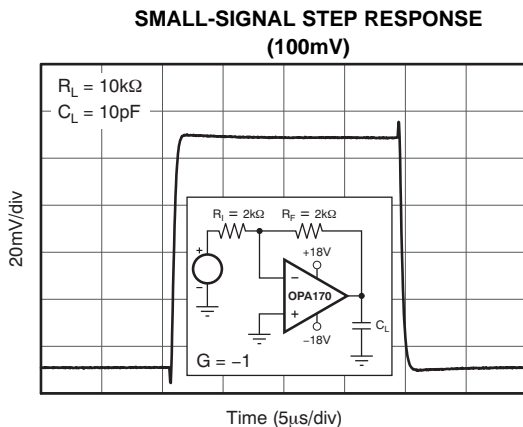

Figure 29.

G029

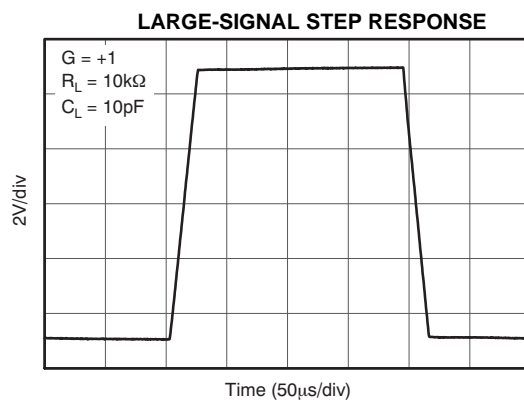

Figure 30.

G030

**TYPICAL CHARACTERISTICS (continued)**

$V_S = \pm 18V$ ,  $V_{CM} = V_S/2$ ,  $R_{LOAD} = 10k\Omega$  connected to  $V_S/2$ , and  $C_L = 100pF$ , unless otherwise noted.

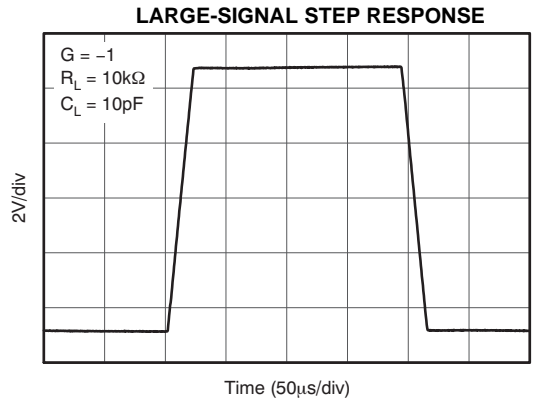

Figure 31.

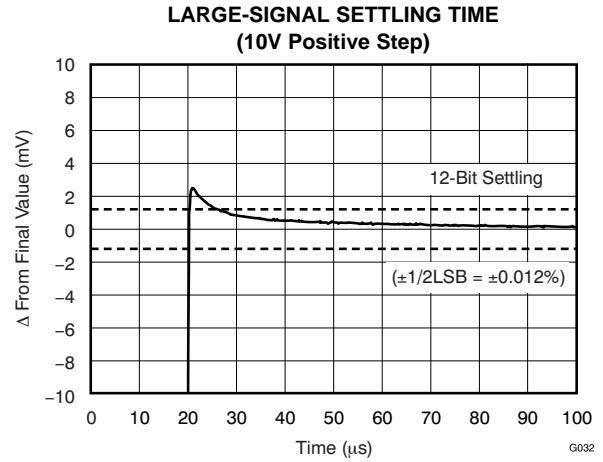

Figure 32.

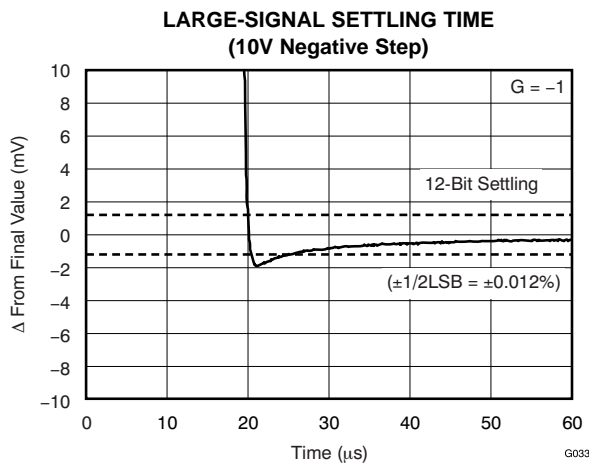

Figure 33.

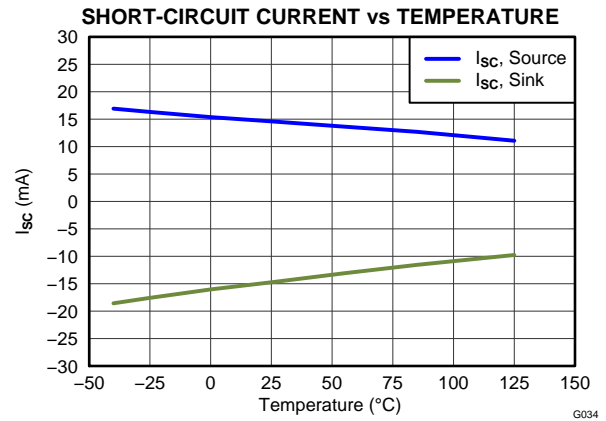

Figure 34.

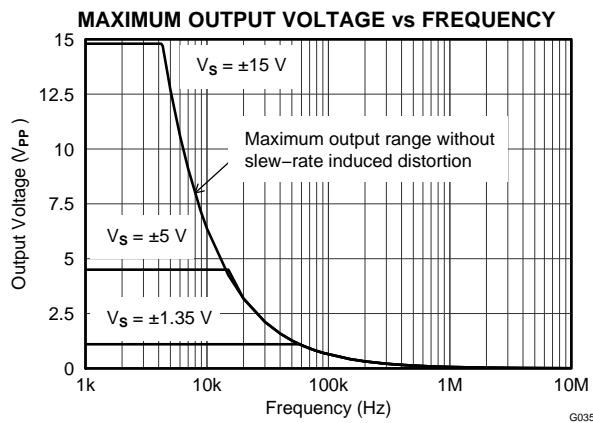

Figure 35.

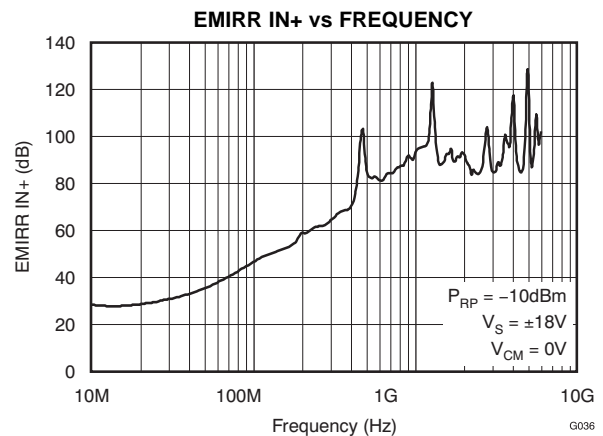

Figure 36.

## APPLICATION INFORMATION

The OPAx170 family of operational amplifiers provides high overall performance. These devices are ideal for many general-purpose applications. The excellent offset drift of only  $2\mu\text{V}/^\circ\text{C}$  provides excellent stability over the entire temperature range. In addition, the device offers very good overall performance with high CMRR, PSRR, and  $A_{OL}$ . As with all amplifiers, applications with noisy or high-impedance power supplies require decoupling capacitors placed close to the device pins. In most cases,  $0.1\mu\text{F}$  capacitors are adequate.

### OPERATING CHARACTERISTICS

The OPAx170 family of amplifiers is specified for operation from 2.7V to 36V ( $\pm 1.35\text{V}$  to  $\pm 18\text{V}$ ). Many of the specifications apply from  $-40^\circ\text{C}$  to  $+125^\circ\text{C}$ . Parameters that can exhibit significant variance with regard to operating voltage or temperature are presented in the [Typical Characteristics](#).

### GENERAL LAYOUT GUIDELINES

For best operational performance of the device, good printed circuit board (PCB) layout practices are recommended. Low-loss,  $0.1\mu\text{F}$  bypass capacitors should be connected between each supply pin and ground, placed as close to the device as possible. A single bypass capacitor from  $V+$  to ground is applicable to single-supply applications.

### COMMON-MODE VOLTAGE RANGE

The input common-mode voltage range of the OPAx170 series extends 100mV below the negative rail and within 2V of the positive rail for normal operation.

This device can operate with full rail-to-rail input 100mV beyond the positive rail, but with reduced performance within 2V of the positive rail. The typical performance in this range is summarized in [Table 2](#).

### PHASE-REVERSAL PROTECTION

The OPAx170 family has an internal phase-reversal protection. Many op amps exhibit a phase reversal when the input is driven beyond its linear common-mode range. This condition is most often encountered in noninverting circuits when the input is driven beyond the specified common-mode voltage range, causing the output to reverse into the opposite rail. The input of the OPAx170 prevents phase reversal with excessive common-mode voltage. Instead, the output limits into the appropriate rail. This performance is shown in [Figure 37](#).

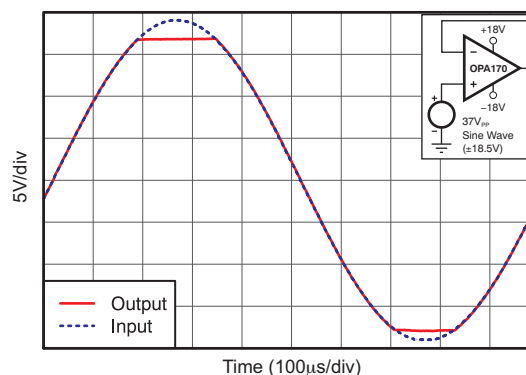

G025

Figure 37. No Phase Reversal

Table 2. Typical Performance Range

| PARAMETER                 | MIN        | TYP | MAX          | UNIT                         |
|---------------------------|------------|-----|--------------|------------------------------|
| Input Common-Mode Voltage | $(V+) - 2$ |     | $(V+) + 0.1$ | V                            |
| Offset voltage            |            | 7   |              | mV                           |
| vs Temperature            |            | 12  |              | $\mu\text{V}/^\circ\text{C}$ |
| Common-mode rejection     |            | 65  |              | dB                           |
| Open-loop gain            |            | 60  |              | dB                           |
| Gain-bandwidth product    |            | 0.3 |              | MHz                          |
| Slew rate                 |            | 0.3 |              | $\text{V}/\mu\text{s}$       |

## CAPACITIVE LOAD AND STABILITY

The dynamic characteristics of the OPAx170 have been optimized for common operating conditions. The combination of low closed-loop gain and high capacitive loads decreases the phase margin of the amplifier and can lead to gain peaking or oscillations. As a result, heavier capacitive loads must be isolated from the output. The simplest way to achieve this isolation is to add a small resistor (for example,  $R_{OUT}$  equal to  $50\Omega$ ) in series with the output. Figure 38 and Figure 39 illustrate graphs of small-signal overshoot versus capacitive load for several values of  $R_{OUT}$ . Also, refer to Applications Bulletin AB-028, *Feedback Plots Define Op Amp AC Performance* (literature number SBOA015, available for download from the TI website), for details of analysis techniques and application circuits.

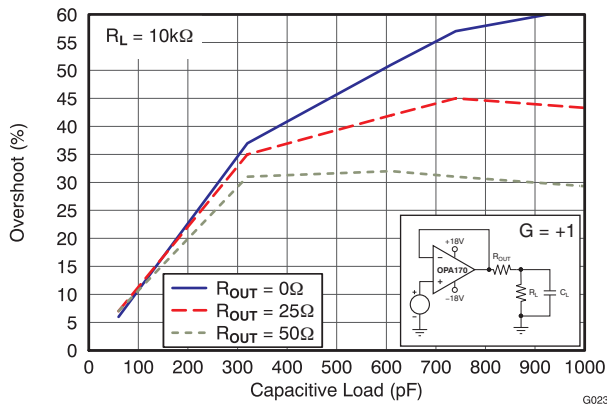

**Figure 38. Small-Signal Overshoot versus Capacitive Load (100mV Output Step,  $G = +1$ )**

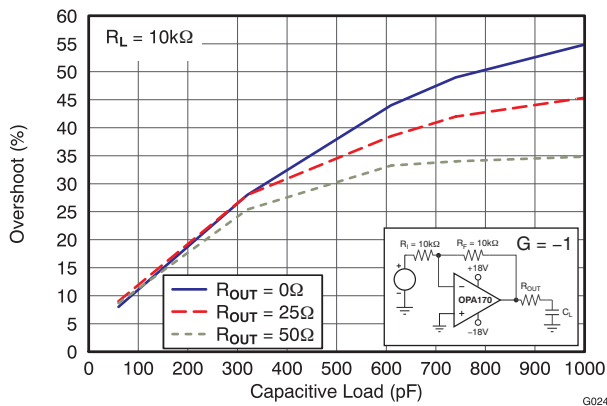

**Figure 39. Small-Signal Overshoot versus Capacitive Load (100mV Output Step,  $G = -1$ )**

## ELECTRICAL OVERSTRESS

Designers often ask questions about the capability of an operational amplifier to withstand electrical overstress. These questions tend to focus on the device inputs, but may involve the supply voltage pins

or even the output pin. Each of these different pin functions have electrical stress limits determined by the voltage breakdown characteristics of the particular semiconductor fabrication process and specific circuits connected to the pin. Additionally, internal electrostatic discharge (ESD) protection is built into these circuits to protect them from accidental ESD events both before and during product assembly.

These ESD protection diodes also provide in-circuit, input overdrive protection, as long as the current is limited to 10mA as stated in the Absolute Maximum Ratings. Figure 40 shows how a series input resistor may be added to the driven input to limit the input current. The added resistor contributes thermal noise at the amplifier input and its value should be kept to a minimum in noise-sensitive applications.

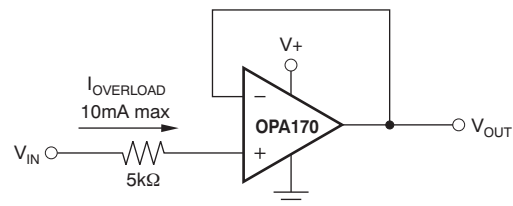

**Figure 40. Input Current Protection**

An ESD event produces a short duration, high-voltage pulse that is transformed into a short duration, high-current pulse as it discharges through a semiconductor device. The ESD protection circuits are designed to provide a current path around the operational amplifier core to prevent it from being damaged. The energy absorbed by the protection circuitry is then dissipated as heat.

When the operational amplifier connects into a circuit, the ESD protection components are intended to remain inactive and not become involved in the application circuit operation. However, circumstances may arise where an applied voltage exceeds the operating voltage range of a given pin. Should this condition occur, there is a risk that some of the internal ESD protection circuits may be biased on, and conduct current. Any such current flow occurs through ESD cells and rarely involves the absorption device.

If there is an uncertainty about the ability of the supply to absorb this current, external zener diodes may be added to the supply pins. The zener voltage must be selected such that the diode does not turn on during normal operation. However, its zener voltage should be low enough so that the zener diode conducts if the supply pin begins to rise above the safe operating supply voltage level.

## REVISION HISTORY

NOTE: Page numbers for previous revision may differ from page numbers in the current version.

| Changes from Revision A (September 2011) to Revision B | Page |
|--|------|
| • Added "Value Line Series" to title .....             | 1    |

**PACKAGING INFORMATION**

| Orderable Device | Status<br>(1) | Package Type | Package<br>Drawing | Pins | Package Qty | Eco Plan<br>(2)            | Lead/Ball Finish | MSL Peak Temp<br>(3) | Op Temp (°C) | Top-Side Markings<br>(4) | Samples                 |
|------------------|---------------|--------------|--------------------|------|-------------|----------------------------|------------------|----------------------|--------------|--------------------------|-------------------------|
| OPA170AID        | ACTIVE        | SOIC         | D                  | 8    | 75          | Green (RoHS<br>& no Sb/Br) | CU NIPDAU        | Level-2-260C-1 YEAR  | -40 to 125   | O170A                    | <a href="#">Samples</a> |
| OPA170AIDBVR     | ACTIVE        | SOT-23       | DBV                | 5    | 3000        | Green (RoHS<br>& no Sb/Br) | CU NIPDAU        | Level-2-260C-1 YEAR  | -40 to 125   | OSVI                     | <a href="#">Samples</a> |
| OPA170AIDBVT     | ACTIVE        | SOT-23       | DBV                | 5    | 250         | Green (RoHS<br>& no Sb/Br) | CU NIPDAU        | Level-2-260C-1 YEAR  | -40 to 125   | OSVI                     | <a href="#">Samples</a> |
| OPA170AIDR       | ACTIVE        | SOIC         | D                  | 8    | 2500        | Green (RoHS<br>& no Sb/Br) | CU NIPDAU        | Level-2-260C-1 YEAR  | -40 to 125   | O170A                    | <a href="#">Samples</a> |
| OPA170AIDRLR     | ACTIVE        | SOT          | DRL                | 5    | 4000        | Green (RoHS<br>& no Sb/Br) | CU NIPDAU        | Level-1-260C-UNLIM   | -40 to 125   | DAQ                      | <a href="#">Samples</a> |
| OPA170AIDRLT     | ACTIVE        | SOT          | DRL                | 5    | 250         | Green (RoHS<br>& no Sb/Br) | CU NIPDAU        | Level-1-260C-UNLIM   | -40 to 125   | DAQ                      | <a href="#">Samples</a> |
| OPA2170AID       | ACTIVE        | SOIC         | D                  | 8    | 75          | Green (RoHS<br>& no Sb/Br) | CU NIPDAU        | Level-2-260C-1 YEAR  | -40 to 125   | 2170A                    | <a href="#">Samples</a> |
| OPA2170AIDCUR    | ACTIVE        | US8          | DCU                | 8    | 3000        | Green (RoHS<br>& no Sb/Br) | CU NIPDAU        | Level-1-260C-UNLIM   | -40 to 125   | OPQC                     | <a href="#">Samples</a> |
| OPA2170AIDCUT    | ACTIVE        | US8          | DCU                | 8    | 250         | Green (RoHS<br>& no Sb/Br) | CU NIPDAU        | Level-1-260C-UNLIM   | -40 to 125   | OPQC                     | <a href="#">Samples</a> |
| OPA2170AIDGK     | ACTIVE        | VSSOP        | DGK                | 8    | 80          | Green (RoHS<br>& no Sb/Br) | CU NIPDAU        | Level-2-260C-1 YEAR  | -40 to 125   | OPNI                     | <a href="#">Samples</a> |
| OPA2170AIDGKR    | ACTIVE        | VSSOP        | DGK                | 8    | 2500        | Green (RoHS<br>& no Sb/Br) | CU NIPDAU        | Level-2-260C-1 YEAR  | -40 to 125   | OPNI                     | <a href="#">Samples</a> |
| OPA2170AIDR      | ACTIVE        | SOIC         | D                  | 8    | 2500        | Green (RoHS<br>& no Sb/Br) | CU NIPDAU        | Level-2-260C-1 YEAR  | -40 to 125   | 2170A                    | <a href="#">Samples</a> |
| OPA4170AID       | ACTIVE        | SOIC         | D                  | 14   | 50          | Green (RoHS<br>& no Sb/Br) | CU NIPDAU        | Level-3-260C-168 HR  | -40 to 125   | OPA4170                  | <a href="#">Samples</a> |
| OPA4170AIDR      | ACTIVE        | SOIC         | D                  | 14   | 2500        | Green (RoHS<br>& no Sb/Br) | CU NIPDAU        | Level-3-260C-168 HR  | -40 to 125   | OPA4170                  | <a href="#">Samples</a> |
| OPA4170AIPW      | ACTIVE        | TSSOP        | PW                 | 14   | 90          | Green (RoHS<br>& no Sb/Br) | CU NIPDAU        | Level-2-260C-1 YEAR  | -40 to 125   | OPA4170                  | <a href="#">Samples</a> |
| OPA4170AIPWR     | ACTIVE        | TSSOP        | PW                 | 14   | 2000        | Green (RoHS<br>& no Sb/Br) | CU NIPDAU        | Level-2-260C-1 YEAR  | -40 to 125   | OPA4170                  | <a href="#">Samples</a> |

(1) The marketing status values are defined as follows:

**ACTIVE:** Product device recommended for new designs.



**LIFEBUY:** TI has announced that the device will be discontinued, and a lifetime-buy period is in effect.

**NRND:** Not recommended for new designs. Device is in production to support existing customers, but TI does not recommend using this part in a new design.

**PREVIEW:** Device has been announced but is not in production. Samples may or may not be available.

**OBSOLETE:** TI has discontinued the production of the device.

<sup>(2)</sup> Eco Plan - The planned eco-friendly classification: Pb-Free (RoHS), Pb-Free (RoHS Exempt), or Green (RoHS & no Sb/Br) - please check <http://www.ti.com/productcontent> for the latest availability information and additional product content details.

**TBD:** The Pb-Free/Green conversion plan has not been defined.

**Pb-Free (RoHS):** TI's terms "Lead-Free" or "Pb-Free" mean semiconductor products that are compatible with the current RoHS requirements for all 6 substances, including the requirement that lead not exceed 0.1% by weight in homogeneous materials. Where designed to be soldered at high temperatures, TI Pb-Free products are suitable for use in specified lead-free processes.

**Pb-Free (RoHS Exempt):** This component has a RoHS exemption for either 1) lead-based flip-chip solder bumps used between the die and package, or 2) lead-based die adhesive used between the die and leadframe. The component is otherwise considered Pb-Free (RoHS compatible) as defined above.

**Green (RoHS & no Sb/Br):** TI defines "Green" to mean Pb-Free (RoHS compatible), and free of Bromine (Br) and Antimony (Sb) based flame retardants (Br or Sb do not exceed 0.1% by weight in homogeneous material)

<sup>(3)</sup> MSL, Peak Temp. -- The Moisture Sensitivity Level rating according to the JEDEC industry standard classifications, and peak solder temperature.

<sup>(4)</sup> Only one of markings shown within the brackets will appear on the physical device.

**Important Information and Disclaimer:** The information provided on this page represents TI's knowledge and belief as of the date that it is provided. TI bases its knowledge and belief on information provided by third parties, and makes no representation or warranty as to the accuracy of such information. Efforts are underway to better integrate information from third parties. TI has taken and continues to take reasonable steps to provide representative and accurate information but may not have conducted destructive testing or chemical analysis on incoming materials and chemicals. TI and TI suppliers consider certain information to be proprietary, and thus CAS numbers and other limited information may not be available for release.

In no event shall TI's liability arising out of such information exceed the total purchase price of the TI part(s) at issue in this document sold by TI to Customer on an annual basis.

#### **OTHER QUALIFIED VERSIONS OF OPA170 :**

- Enhanced Product: [OPA170-EP](#)

NOTE: Qualified Version Definitions:

- Enhanced Product - Supports Defense, Aerospace and Medical Applications

**TAPE AND REEL INFORMATION**

**QUADRANT ASSIGNMENTS FOR PIN 1 ORIENTATION IN TAPE**

\*All dimensions are nominal

| Device        | Package Type | Package Drawing | Pins | SPQ  | Reel Diameter (mm) | Reel Width W1 (mm) | A0 (mm) | B0 (mm) | K0 (mm) | P1 (mm) | W (mm) | Pin1 Quadrant |
|---------------|--------------|-----------------|------|------|--------------------|--------------------|---------|---------|---------|---------|--------|---------------|
| OPA170AIDBVR  | SOT-23       | DBV             | 5    | 3000 | 180.0              | 8.4                | 3.23    | 3.17    | 1.37    | 4.0     | 8.0    | Q3            |
| OPA170AIDBVT  | SOT-23       | DBV             | 5    | 250  | 180.0              | 8.4                | 3.23    | 3.17    | 1.37    | 4.0     | 8.0    | Q3            |
| OPA170AIDR    | SOIC         | D               | 8    | 2500 | 330.0              | 12.4               | 6.4     | 5.2     | 2.1     | 8.0     | 12.0   | Q1            |
| OPA170AIDRLR  | SOT          | DRL             | 5    | 4000 | 180.0              | 8.4                | 1.98    | 1.78    | 0.69    | 4.0     | 8.0    | Q3            |
| OPA170AIDRLT  | SOT          | DRL             | 5    | 250  | 180.0              | 8.4                | 1.98    | 1.78    | 0.69    | 4.0     | 8.0    | Q3            |
| OPA2170AIDGKR | VSSOP        | DGK             | 8    | 2500 | 330.0              | 12.4               | 5.3     | 3.4     | 1.4     | 8.0     | 12.0   | Q1            |
| OPA2170AIDR   | SOIC         | D               | 8    | 2500 | 330.0              | 12.4               | 6.4     | 5.2     | 2.1     | 8.0     | 12.0   | Q1            |
| OPA4170AIDR   | SOIC         | D               | 14   | 2500 | 330.0              | 16.4               | 6.5     | 9.0     | 2.1     | 8.0     | 16.0   | Q1            |
| OPA4170AIPWR  | TSSOP        | PW              | 14   | 2000 | 330.0              | 12.4               | 6.9     | 5.6     | 1.6     | 8.0     | 12.0   | Q1            |

**TAPE AND REEL BOX DIMENSIONS**



\*All dimensions are nominal

| Device        | Package Type | Package Drawing | Pins | SPQ  | Length (mm) | Width (mm) | Height (mm) |
|---------------|--------------|-----------------|------|------|-------------|------------|-------------|
| OPA170AIDBVR  | SOT-23       | DBV             | 5    | 3000 | 202.0       | 201.0      | 28.0        |
| OPA170AIDBVT  | SOT-23       | DBV             | 5    | 250  | 202.0       | 201.0      | 28.0        |
| OPA170AIDR    | SOIC         | D               | 8    | 2500 | 367.0       | 367.0      | 35.0        |
| OPA170AIDRLR  | SOT          | DRL             | 5    | 4000 | 202.0       | 201.0      | 28.0        |
| OPA170AIDRLT  | SOT          | DRL             | 5    | 250  | 202.0       | 201.0      | 28.0        |
| OPA2170AIDGKR | VSSOP        | DGK             | 8    | 2500 | 366.0       | 364.0      | 50.0        |
| OPA2170AIDR   | SOIC         | D               | 8    | 2500 | 367.0       | 367.0      | 35.0        |
| OPA4170AIDR   | SOIC         | D               | 14   | 2500 | 367.0       | 367.0      | 38.0        |
| OPA4170AIPWR  | TSSOP        | PW              | 14   | 2000 | 367.0       | 367.0      | 35.0        |

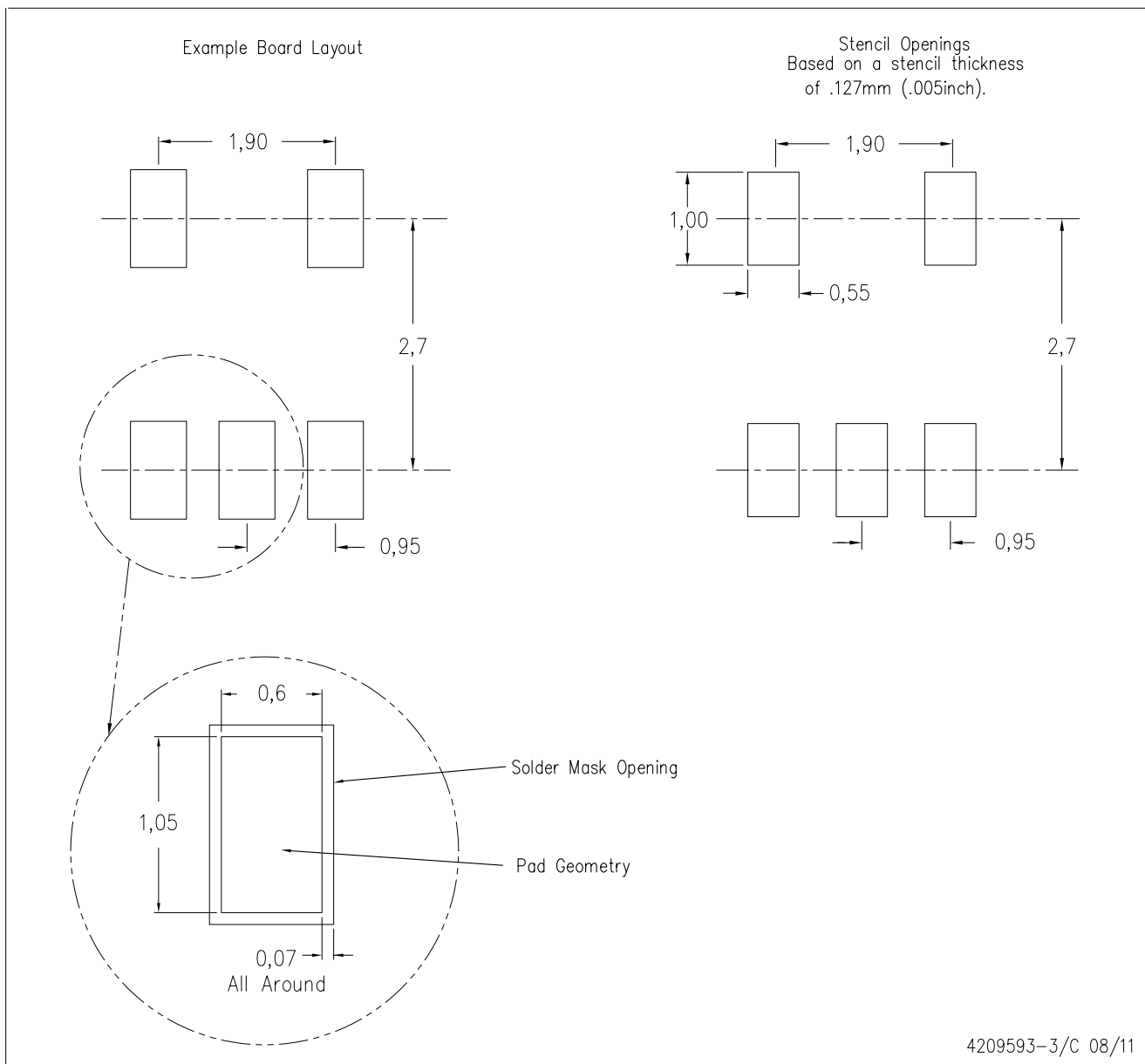

DBV (R-PDSO-G5)

PLASTIC SMALL OUTLINE



- NOTES:
- A. All linear dimensions are in millimeters.
  - B. This drawing is subject to change without notice.
  - C. Customers should place a note on the circuit board fabrication drawing not to alter the center solder mask defined pad.
  - D. Publication IPC-7351 is recommended for alternate designs.
  - E. Laser cutting apertures with trapezoidal walls and also rounding corners will offer better paste release. Customers should contact their board assembly site for stencil design recommendations. Example stencil design based on a 50% volumetric metal load solder paste. Refer to IPC-7525 for other stencil recommendations.

DGK (S-PDSO-G8)

PLASTIC SMALL-OUTLINE PACKAGE

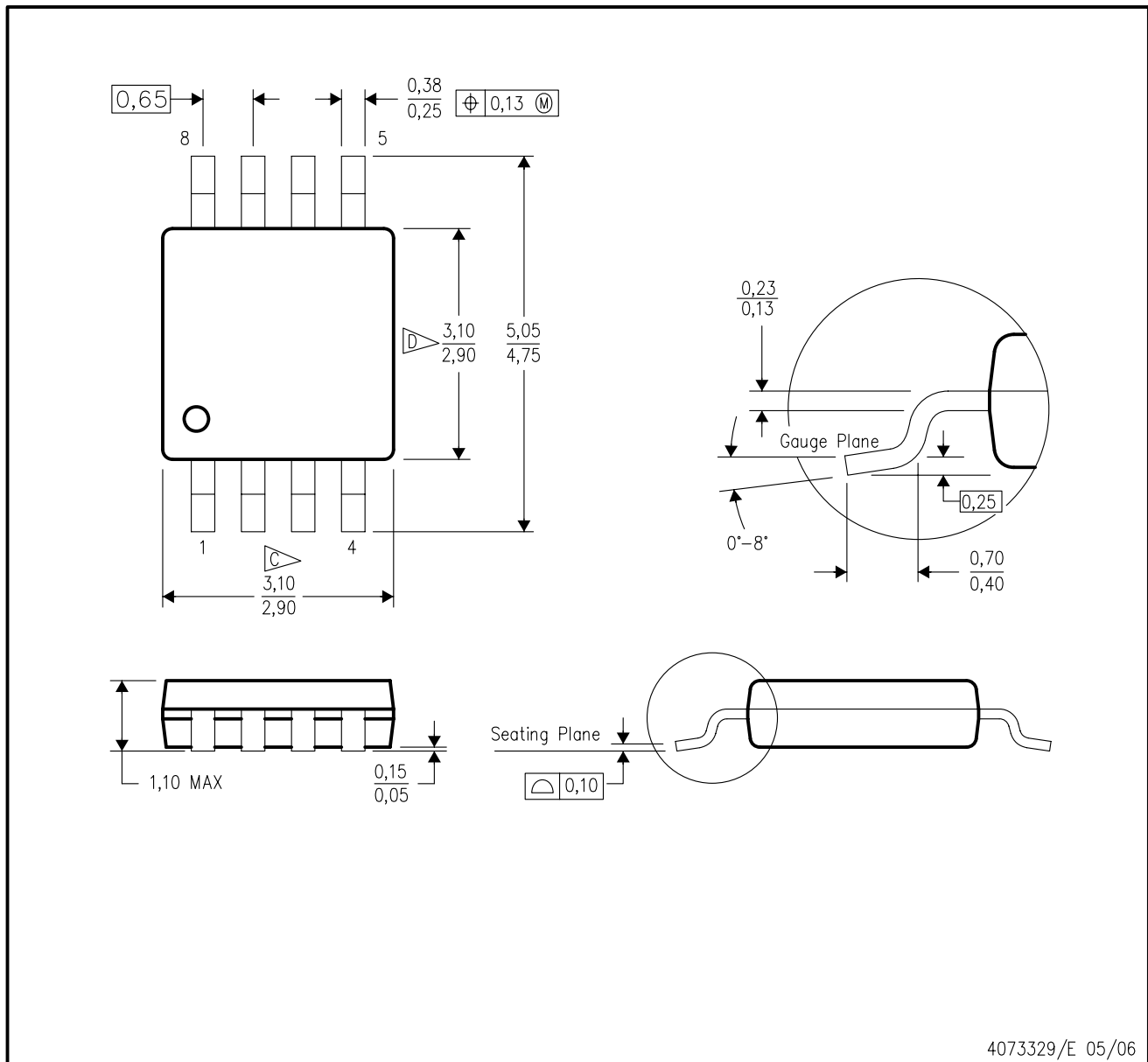

4073329/E 05/06

- NOTES:
- A. All linear dimensions are in millimeters.
  - B. This drawing is subject to change without notice.
  - C. Body length does not include mold flash, protrusions, or gate burrs. Mold flash, protrusions, or gate burrs shall not exceed 0.15 per end.
  - D. Body width does not include interlead flash. Interlead flash shall not exceed 0.50 per side.
  - E. Falls within JEDEC MO-187 variation AA, except interlead flash.



DCU (S-PDSO-G8)

PLASTIC SMALL OUTLINE PACKAGE (DIE DOWN)

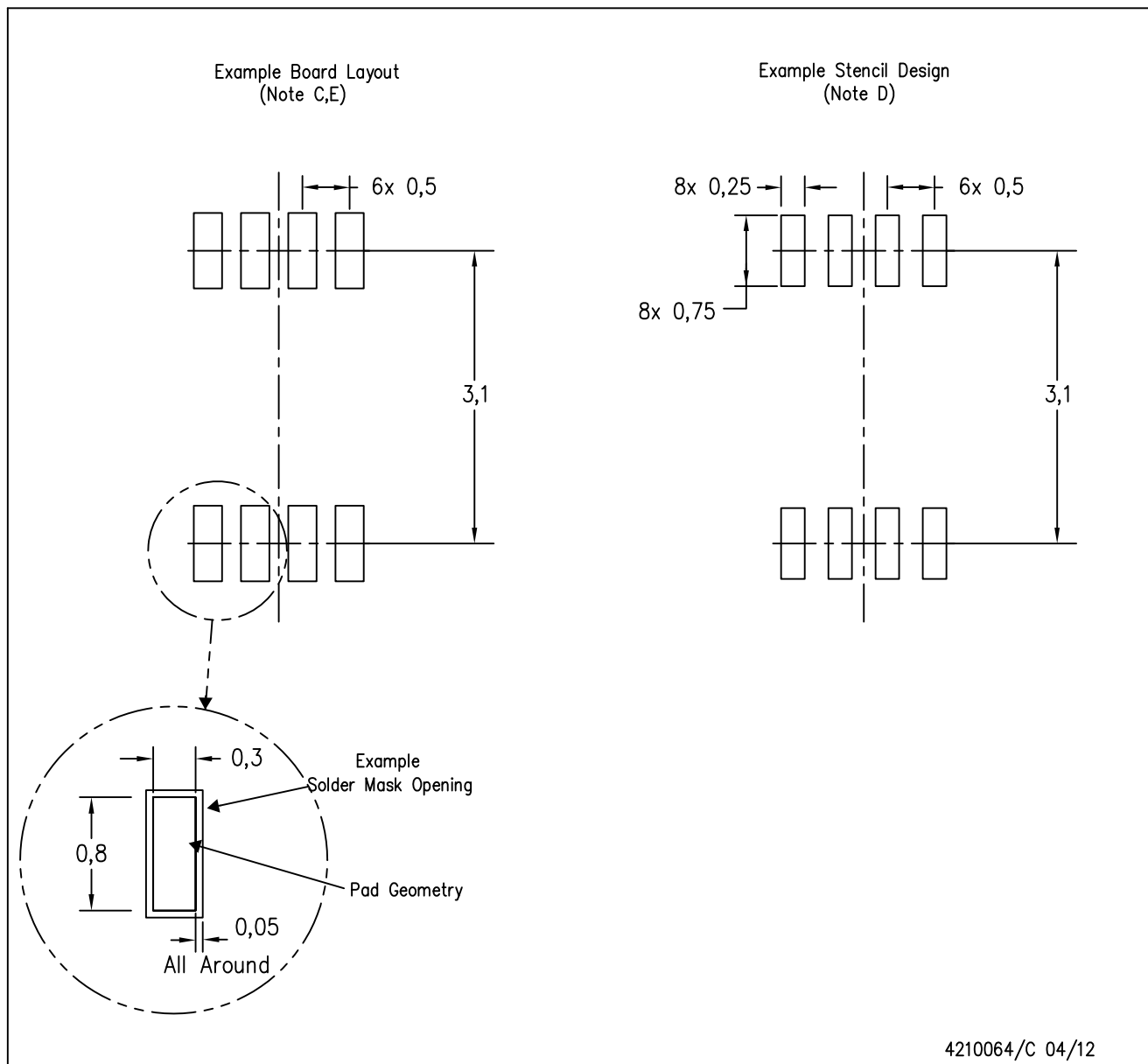

4210064/C 04/12

- NOTES:
- A. All linear dimensions are in millimeters.
  - B. This drawing is subject to change without notice.
  - C. Publication IPC-7351 is recommended for alternate designs.
  - D. Laser cutting apertures with trapezoidal walls and also rounding corners will offer better paste release. Customers should contact their board assembly site for stencil design recommendations. Refer to IPC-7525 for other stencil recommendations.
  - E. Customers should contact their board fabrication site for solder mask tolerances between and around signal pads.



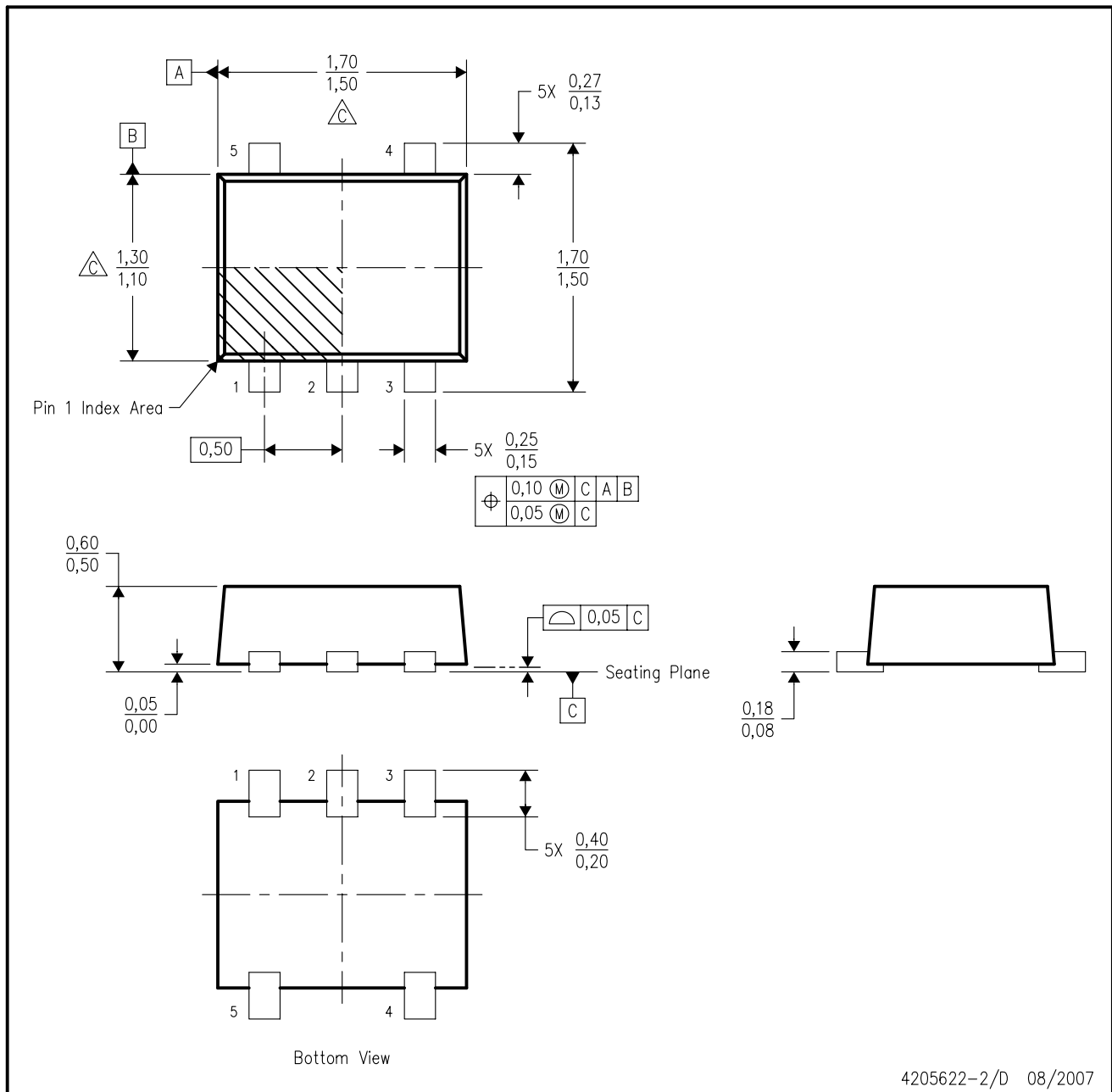

4205622-2/D 08/2007

- NOTES:
- A. All linear dimensions are in millimeters. Dimensioning and tolerancing per ASME Y14.5M-1994.
  - B. This drawing is subject to change without notice.
  - C. Body dimensions do not include mold flash, interlead flash, protrusions, or gate burrs. Mold flash, interlead flash, protrusions, or gate burrs shall not exceed 0,15 per end or side.
  - D. JEDEC package registration is pending.

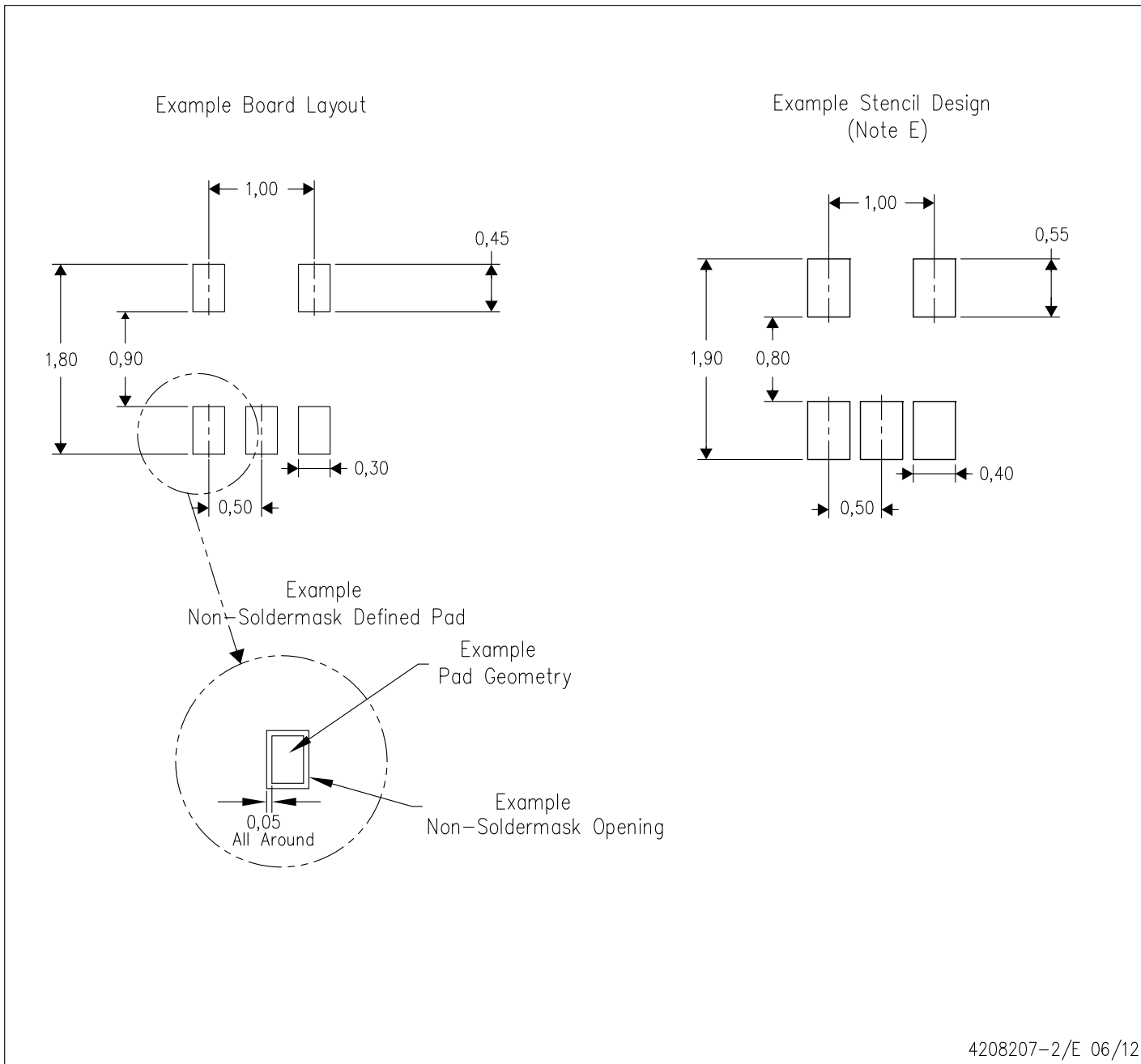



- NOTES:
- All linear dimensions are in millimeters.
  - This drawing is subject to change without notice.
  - Publication IPC-7351 is recommended for alternate designs.
  - Customers should contact their board fabrication site for minimum solder mask web tolerances between signal pads.
  - Maximum stencil thickness 0,127 mm (5 mils). All linear dimensions are in millimeters.
  - Laser cutting apertures with trapezoidal walls and also rounding corners will offer better paste release. Customers should contact their board assembly site for stencil design recommendations. Refer to IPC 7525 for stencil design considerations.
  - Side aperture dimensions over-print land for acceptable area ratio > 0.66. Customer may reduce side aperture dimensions if stencil manufacturing process allows for sufficient release at smaller opening.

D (R-PDSO-G14)

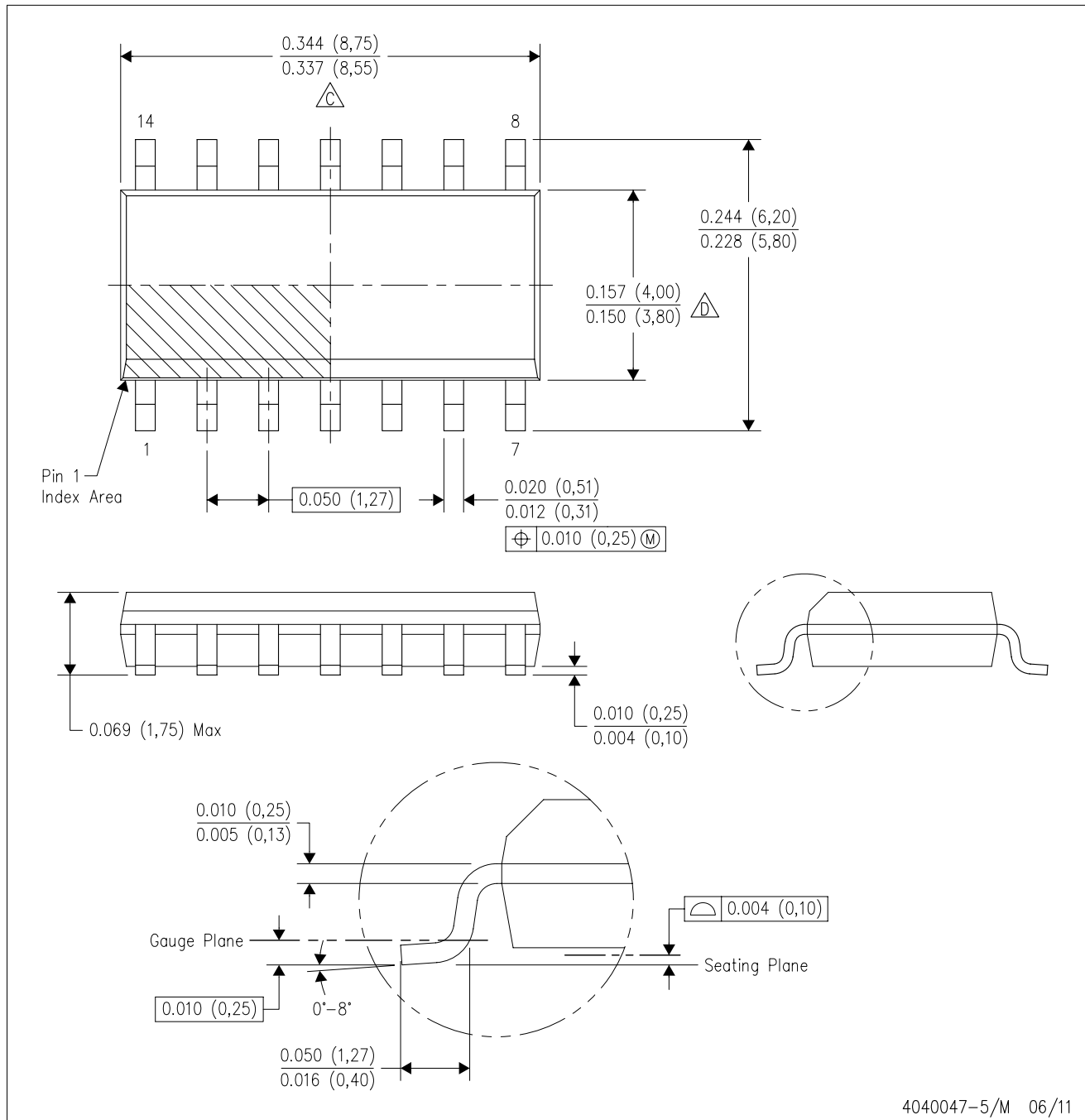
PLASTIC SMALL OUTLINE



4040047-5/M 06/11

- NOTES:
- A. All linear dimensions are in inches (millimeters).
  - B. This drawing is subject to change without notice.
  -  Body length does not include mold flash, protrusions, or gate burrs. Mold flash, protrusions, or gate burrs shall not exceed 0.006 (0,15) each side.
  -  Body width does not include interlead flash. Interlead flash shall not exceed 0.017 (0,43) each side.
  - E. Reference JEDEC MS-012 variation AB.

D (R-PDSO-G14)

PLASTIC SMALL OUTLINE



- NOTES:
- All linear dimensions are in millimeters.
  - This drawing is subject to change without notice.
  - Publication IPC-7351 is recommended for alternate designs.
  - Laser cutting apertures with trapezoidal walls and also rounding corners will offer better paste release. Customers should contact their board assembly site for stencil design recommendations. Refer to IPC-7525 for other stencil recommendations.
  - Customers should contact their board fabrication site for solder mask tolerances between and around signal pads.

PW (R-PDSO-G14)

PLASTIC SMALL OUTLINE

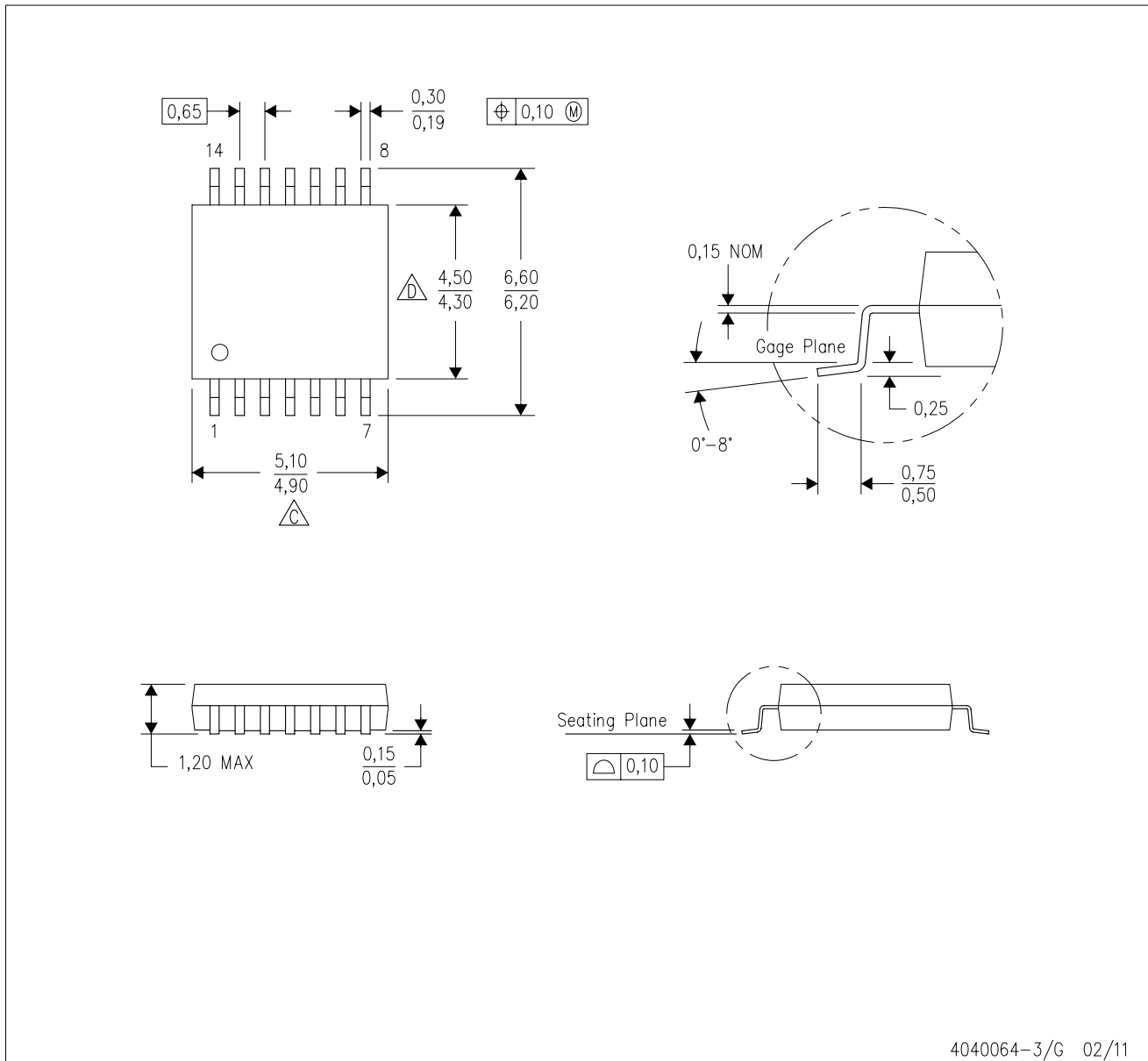

4040064-3/G 02/11

- NOTES:
- A. All linear dimensions are in millimeters. Dimensioning and tolerancing per ASME Y14.5M-1994.
  - B. This drawing is subject to change without notice.
  - C. Body length does not include mold flash, protrusions, or gate burrs. Mold flash, protrusions, or gate burrs shall not exceed 0,15 each side.
  - D. Body width does not include interlead flash. Interlead flash shall not exceed 0,25 each side.
  - E. Falls within JEDEC MO-153

PW (R-PDSO-G14)

PLASTIC SMALL OUTLINE

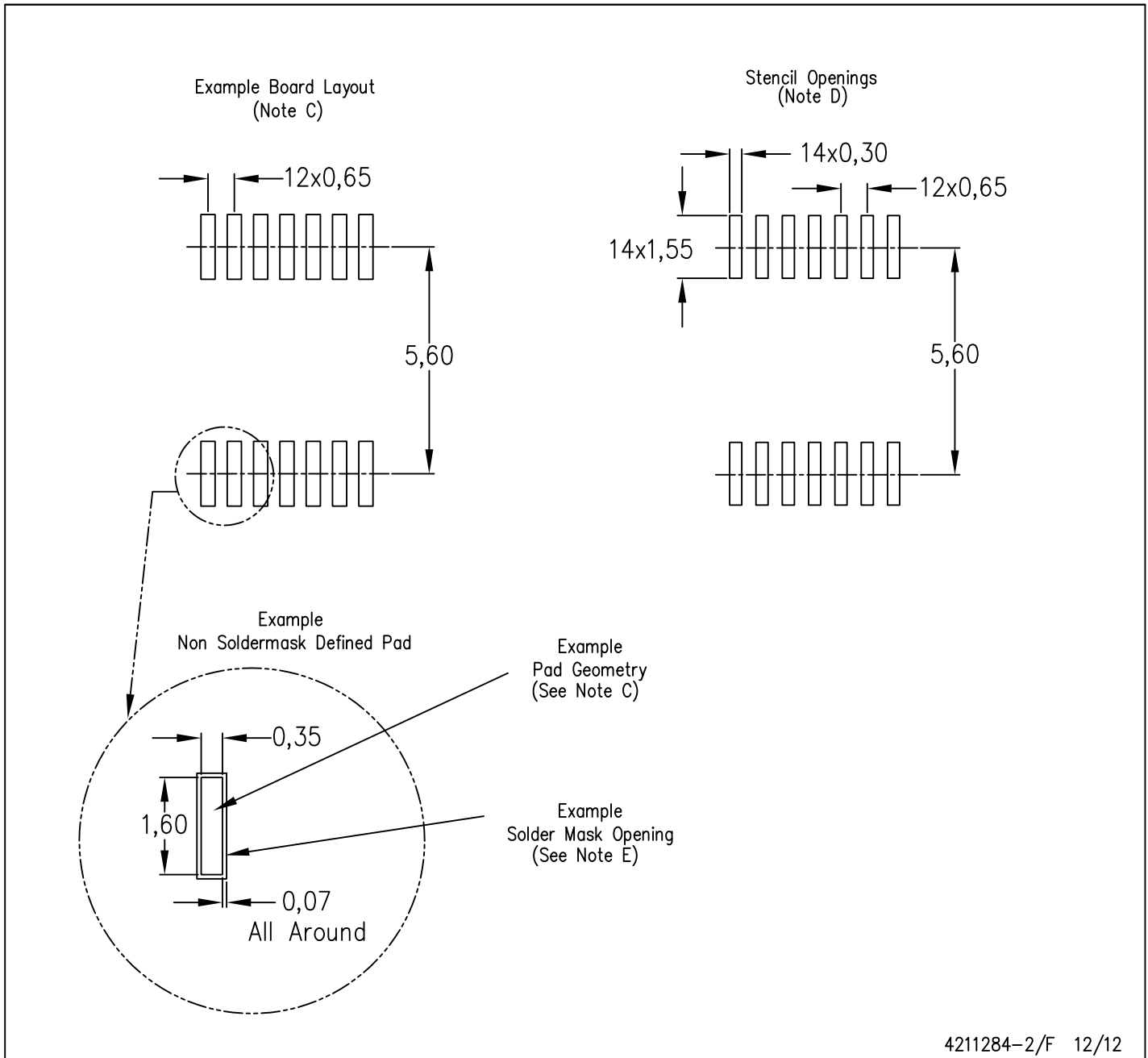

- NOTES:
- All linear dimensions are in millimeters.
  - This drawing is subject to change without notice.
  - Publication IPC-7351 is recommended for alternate designs.
  - Laser cutting apertures with trapezoidal walls and also rounding corners will offer better paste release. Customers should contact their board assembly site for stencil design recommendations. Refer to IPC-7525 for other stencil recommendations.
  - Customers should contact their board fabrication site for solder mask tolerances between and around signal pads.



D (R-PDSO-G8)

PLASTIC SMALL OUTLINE

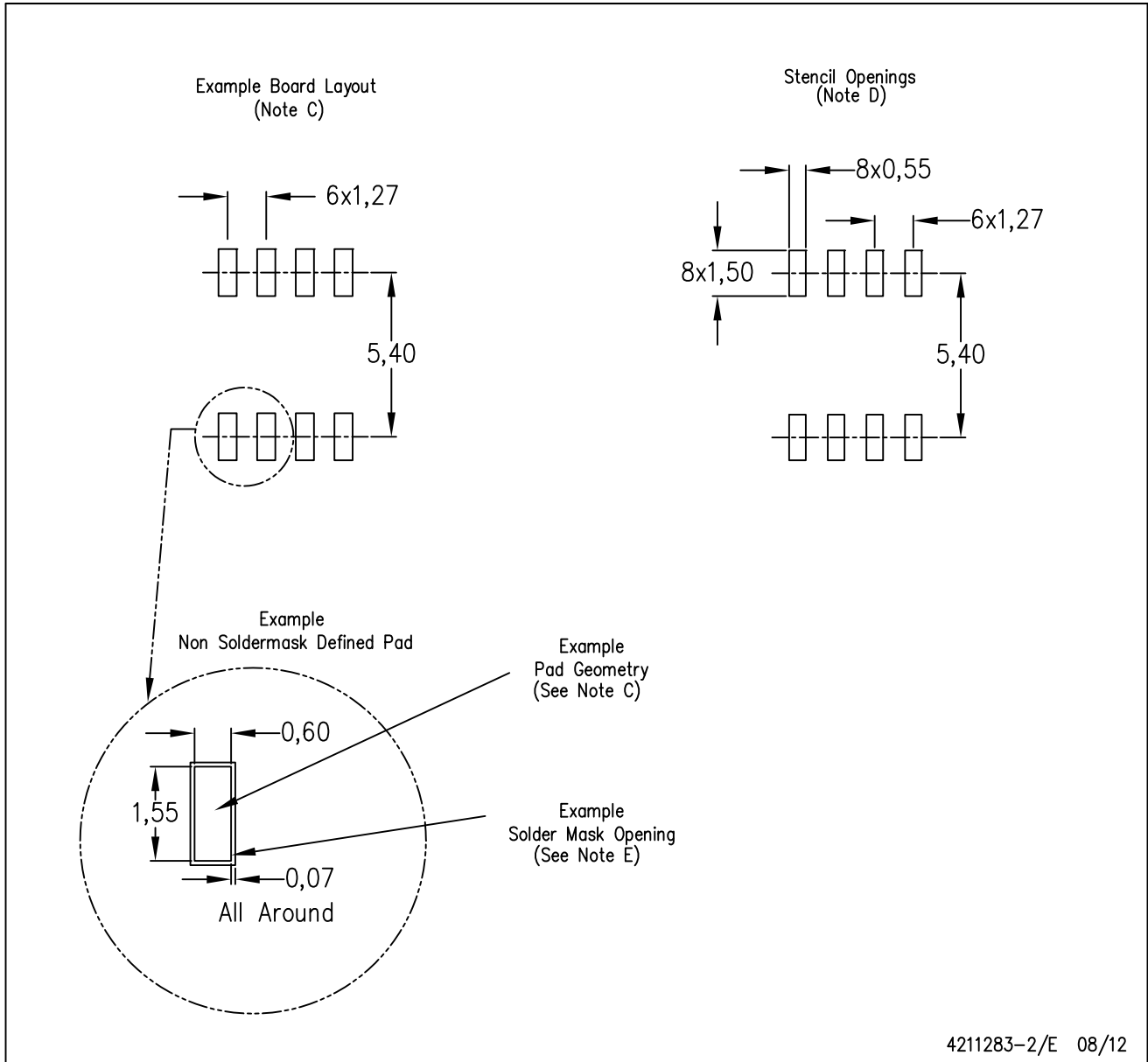

- NOTES:
- A. All linear dimensions are in millimeters.
  - B. This drawing is subject to change without notice.
  - C. Publication IPC-7351 is recommended for alternate designs.
  - D. Laser cutting apertures with trapezoidal walls and also rounding corners will offer better paste release. Customers should contact their board assembly site for stencil design recommendations. Refer to IPC-7525 for other stencil recommendations.
  - E. Customers should contact their board fabrication site for solder mask tolerances between and around signal pads.



## IMPORTANT NOTICE

Texas Instruments Incorporated and its subsidiaries (TI) reserve the right to make corrections, enhancements, improvements and other changes to its semiconductor products and services per JESD46, latest issue, and to discontinue any product or service per JESD48, latest issue. Buyers should obtain the latest relevant information before placing orders and should verify that such information is current and complete. All semiconductor products (also referred to herein as "components") are sold subject to TI's terms and conditions of sale supplied at the time of order acknowledgment.

TI warrants performance of its components to the specifications applicable at the time of sale, in accordance with the warranty in TI's terms and conditions of sale of semiconductor products. Testing and other quality control techniques are used to the extent TI deems necessary to support this warranty. Except where mandated by applicable law, testing of all parameters of each component is not necessarily performed.

TI assumes no liability for applications assistance or the design of Buyers' products. Buyers are responsible for their products and applications using TI components. To minimize the risks associated with Buyers' products and applications, Buyers should provide adequate design and operating safeguards.

TI does not warrant or represent that any license, either express or implied, is granted under any patent right, copyright, mask work right, or other intellectual property right relating to any combination, machine, or process in which TI components or services are used. Information published by TI regarding third-party products or services does not constitute a license to use such products or services or a warranty or endorsement thereof. Use of such information may require a license from a third party under the patents or other intellectual property of the third party, or a license from TI under the patents or other intellectual property of TI.

Reproduction of significant portions of TI information in TI data books or data sheets is permissible only if reproduction is without alteration and is accompanied by all associated warranties, conditions, limitations, and notices. TI is not responsible or liable for such altered documentation. Information of third parties may be subject to additional restrictions.

Resale of TI components or services with statements different from or beyond the parameters stated by TI for that component or service voids all express and any implied warranties for the associated TI component or service and is an unfair and deceptive business practice. TI is not responsible or liable for any such statements.

Buyer acknowledges and agrees that it is solely responsible for compliance with all legal, regulatory and safety-related requirements concerning its products, and any use of TI components in its applications, notwithstanding any applications-related information or support that may be provided by TI. Buyer represents and agrees that it has all the necessary expertise to create and implement safeguards which anticipate dangerous consequences of failures, monitor failures and their consequences, lessen the likelihood of failures that might cause harm and take appropriate remedial actions. Buyer will fully indemnify TI and its representatives against any damages arising out of the use of any TI components in safety-critical applications.

In some cases, TI components may be promoted specifically to facilitate safety-related applications. With such components, TI's goal is to help enable customers to design and create their own end-product solutions that meet applicable functional safety standards and requirements. Nonetheless, such components are subject to these terms.

No TI components are authorized for use in FDA Class III (or similar life-critical medical equipment) unless authorized officers of the parties have executed a special agreement specifically governing such use.

Only those TI components which TI has specifically designated as military grade or "enhanced plastic" are designed and intended for use in military/aerospace applications or environments. Buyer acknowledges and agrees that any military or aerospace use of TI components which have **not** been so designated is solely at the Buyer's risk, and that Buyer is solely responsible for compliance with all legal and regulatory requirements in connection with such use.

TI has specifically designated certain components as meeting ISO/TS16949 requirements, mainly for automotive use. In any case of use of non-designated products, TI will not be responsible for any failure to meet ISO/TS16949.

### Products

|                              |  |
|------------------------------|--|
| Audio                        | <a href="http://www.ti.com/audio">www.ti.com/audio</a>                               |
| Amplifiers                   | <a href="http://amplifier.ti.com">amplifier.ti.com</a>                               |
| Data Converters              | <a href="http://dataconverter.ti.com">dataconverter.ti.com</a>                       |
| DLP® Products                | <a href="http://www.dlp.com">www.dlp.com</a>   |
| DSP                          | <a href="http://dsp.ti.com">dsp.ti.com</a>   |
| Clocks and Timers            | <a href="http://www.ti.com/clocks">www.ti.com/clocks</a>                             |
| Interface                    | <a href="http://interface.ti.com">interface.ti.com</a>                               |
| Logic                        | <a href="http://logic.ti.com">logic.ti.com</a>                                       |
| Power Mgmt                   | <a href="http://power.ti.com">power.ti.com</a>                                       |
| Microcontrollers             | <a href="http://microcontroller.ti.com">microcontroller.ti.com</a>                   |
| RFID                         | <a href="http://www.ti-rfid.com">www.ti-rfid.com</a>                                 |
| OMAP Applications Processors | <a href="http://www.ti.com/omap">www.ti.com/omap</a>                                 |
| Wireless Connectivity        | <a href="http://www.ti.com/wirelessconnectivity">www.ti.com/wirelessconnectivity</a> |

### Applications

|                               |  |
|-------------------------------|--|
| Automotive and Transportation | <a href="http://www.ti.com/automotive">www.ti.com/automotive</a>                         |
| Communications and Telecom    | <a href="http://www.ti.com/communications">www.ti.com/communications</a>                 |
| Computers and Peripherals     | <a href="http://www.ti.com/computers">www.ti.com/computers</a>                           |
| Consumer Electronics          | <a href="http://www.ti.com/consumer-apps">www.ti.com/consumer-apps</a>                   |
| Energy and Lighting           | <a href="http://www.ti.com/energy">www.ti.com/energy</a>                                 |
| Industrial                    | <a href="http://www.ti.com/industrial">www.ti.com/industrial</a>                         |
| Medical                       | <a href="http://www.ti.com/medical">www.ti.com/medical</a>                               |
| Security                      | <a href="http://www.ti.com/security">www.ti.com/security</a>                             |
| Space, Avionics and Defense   | <a href="http://www.ti.com/space-avionics-defense">www.ti.com/space-avionics-defense</a> |
| Video and Imaging             | <a href="http://www.ti.com/video">www.ti.com/video</a>                                   |

### TI E2E Community

[e2e.ti.com](http://e2e.ti.com)