

Cree® P4 LED

Model # LP377FWH1-90G

Data Sheet

90-degree, 7.6x7.6mm LED lamp in white color with water-transparent lens and stopper

Applications

- Indicators
- Illuminations

Absolute Maximum Ratings ($T_A = 25^\circ\text{C}$)

Items	Symbol	Absolute Maximum Rating	Unit
Forward Current	I_F	30	mA
Peak Forward Current ^{Note 1}	I_{FP}	100	mA
Reverse Voltage	V_R	5	V
Power Dissipation	P_D	132	mW
Operation Temperature	T_{opr}	-40 ~ +95	°C
Storage Temperature	T_{stg}	-40 ~ +100	°C
Lead Soldering Temperature	T_{sol}	Max 260° for 3 sec. max. (3 mm from the base of the epoxy bulb)	

Note: Pulse width ≤ 0.1 msec, duty $\leq 1/10$.

Typical Electrical & Optical Characteristics ($T_A = 25^\circ\text{C}$)

Characteristics	Symbol	Condition	Unit	Minimum	Typical	Maximum
Forward Voltage	V_F	$I_F = 30$ mA	V		3.6	4.4
Reverse Current	I_R	$V_R = 5$ V	μA			100
Luminous Flux	Φ_V	$I_F = 30$ mA	mlm	3850	7000	
Luminous Intensity	I_V	$I_F = 30$ mA	mcd		3000	
Chromaticity Coordinates	x	$I_F = 30$ mA			0.2830	
	y	$I_F = 30$ mA			0.2640	
50% Power Angle	$2\theta_{1/2}$	$I_F = 30$ mA	deg		90	

Standard Bins for LP377FWH1-90G ($I_f = 30 \text{ mA}$)

Lamps are sorted to luminous flux (ϕ_v), V_f and chromaticity coordinates (x,y) bins shown.

Orders for LP377FWH1-90G may be filled with any or all bins contained as below.

All luminous flux (ϕ_v), V_f and chromaticity coordinates (x,y) values shown and specified are at $I_f = 30 \text{ mA}$.

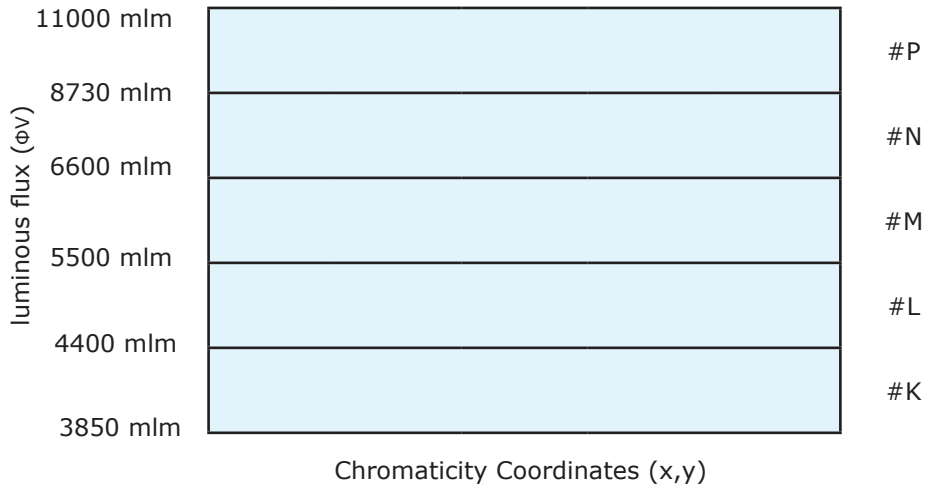

Rank		A11				A12				A13			
Chromaticity Coordinates	x	0.2450	0.2545	0.2633	0.2545	0.2633	0.2720	0.2640	0.2545	0.2545	0.2640	0.2720	0.2633
	y	0.2290	0.2480	0.2410	0.2245	0.2410	0.2340	0.2200	0.2245	0.2480	0.2670	0.2575	0.2410

Rank		A14				A21				A22			
Chromaticity Coordinates	x	0.2633	0.2720	0.2800	0.2720	0.2640	0.2735	0.2808	0.2720	0.2720	0.2808	0.2880	0.2800
	y	0.2410	0.2575	0.2480	0.2340	0.2670	0.2860	0.2740	0.2575	0.2575	0.2740	0.2620	0.2480

Rank		A23				A24				B11			
Chromaticity Coordinates	x	0.2735	0.2830	0.2895	0.2808	0.2808	0.2895	0.2960	0.2880	0.2830	0.2950	0.2998	0.2895
	y	0.2860	0.3050	0.2905	0.2740	0.2740	0.2905	0.2760	0.2620	0.3050	0.3210	0.3028	0.2905

Rank		B12				B13				B14			
Chromaticity Coordinates	x	0.2895	0.2998	0.3045	0.2960	0.2950	0.3070	0.3100	0.3000	0.3000	0.3100	0.3130	0.3050
	y	0.2905	0.3028	0.2865	0.2760	0.3210	0.3370	0.3150	0.3030	0.3030	0.3150	0.2970	0.2870

Rank		B21				B22				B23			
Chromaticity Coordinates	x	0.3070	0.3190	0.3200	0.3100	0.3100	0.3200	0.3220	0.3130	0.3190	0.3300	0.3300	0.3200
	y	0.3370	0.3490	0.3270	0.3150	0.3150	0.3270	0.3080	0.2970	0.3490	0.3600	0.3390	0.3270

Rank		B24			
Chromaticity Coordinates	x	0.3200	0.3300	0.3300	0.3220
	y	0.3270	0.3390	0.3180	0.3080

Forward Voltage (V_F)

Rank	V7	V8	V9	V10	V11	V12	V13	V14
Forward Voltage	2.8 - 3.0 V	3.0 - 3.2 V	3.2 - 3.4 V	3.4 - 3.6 V	3.6 - 3.8 V	3.8 - 4.0 V	4.0 - 4.2 V	4.2 - 4.4 V

Important Notes:

1. All ranks will be included per delivery; rank ratio will be based on the dice distribution.
2. Tolerance of measurement of luminous flux is $\pm 15\%$.
3. Tolerance of measurement of the Color Coordinates is ± 0.01 .
4. Tolerance of measurement of V_F is ± 0.05 V.
5. Packaging methods are available for selection; please refer to the "Cree LED Lamp Packaging Standard" document.
6. Please refer to the "Cree LED Lamp Reliability Test Standards" document for reliability test conditions.
7. Please refer to the "Cree LED Lamp Soldering & Handling" document for information about how to use this LED product safely.

CIE Chromaticity Diagram

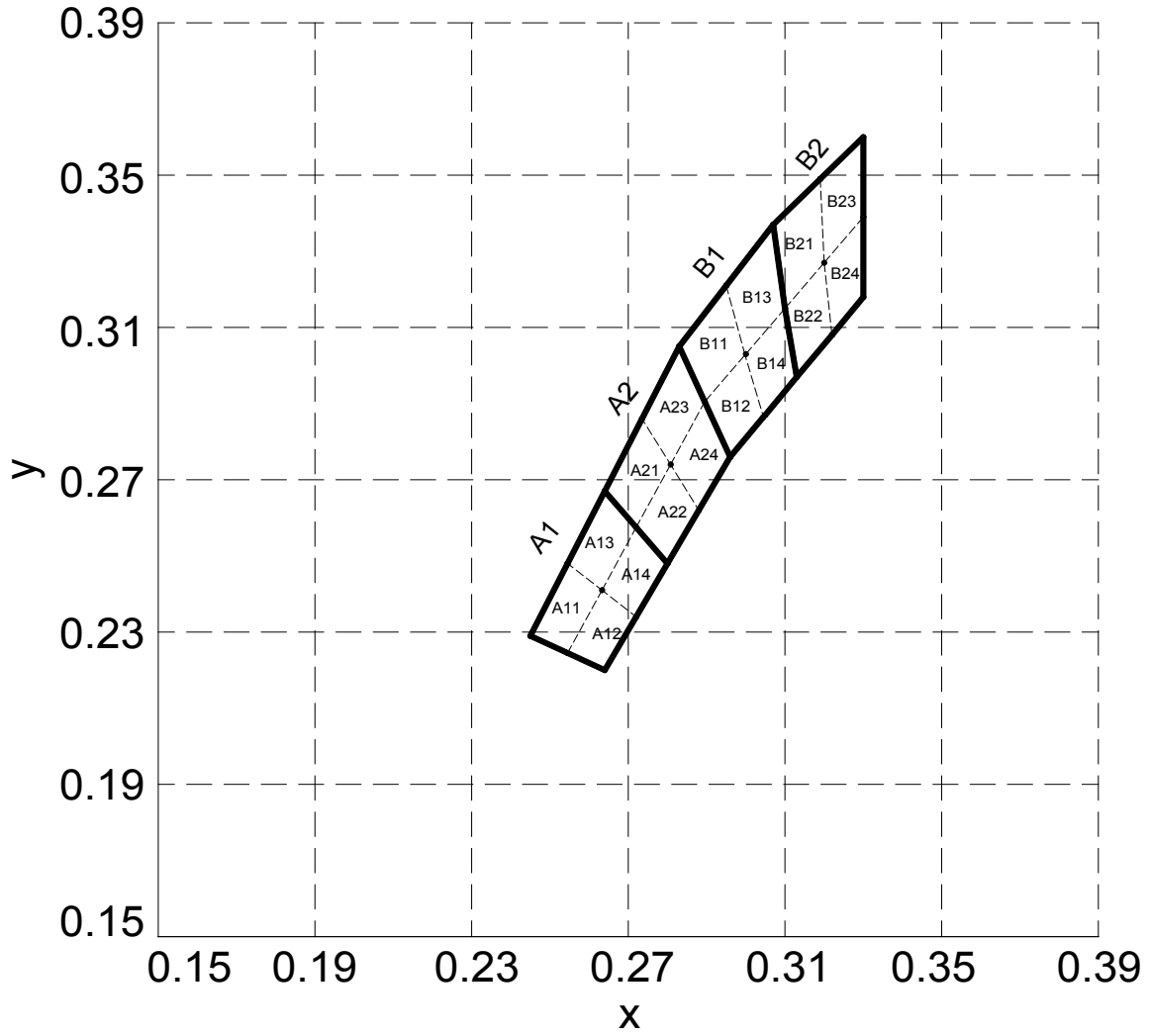

Graphs

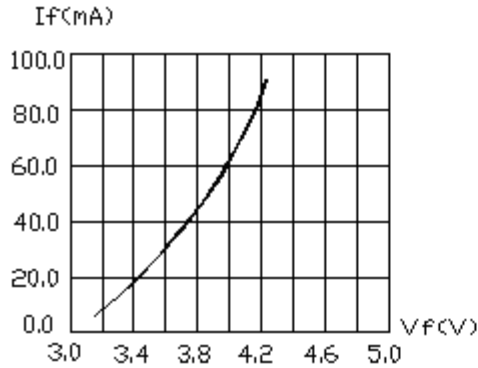

FIG.1 FORWARD CURRENT VS. FORWARD VOLTAGE

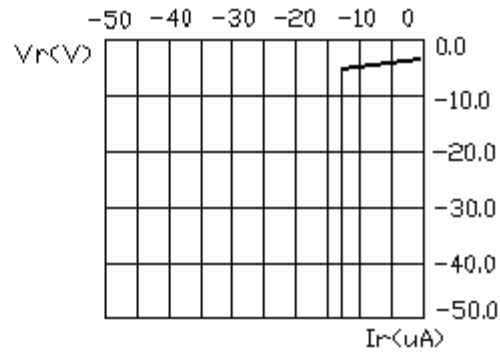

FIG.2 REVERSE CURRENT VS. REVERSE VOLTAGE

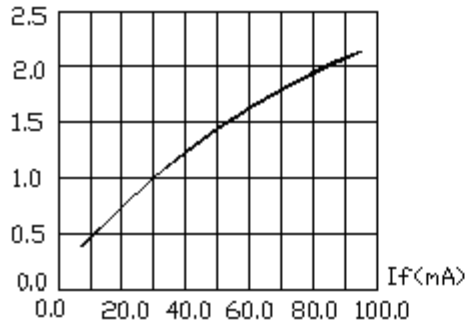

FIG.3 RELATIVE LUMINOUS INTENSITY VS. FORWARD CURRENT

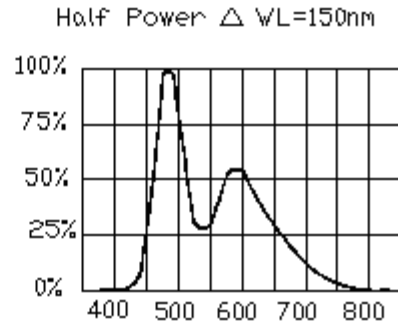

FIG.4 RELATIVE LUMINOUS INTENSITY VS. WAVELENGTH.

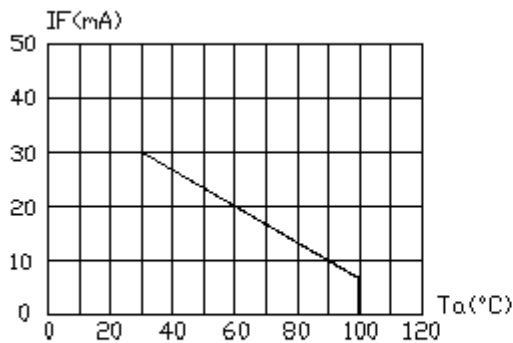

FIG.5 MAXIMUM FORWARD CURRENT VS. AMBIENT TEMPERATURE (T_{Jmax}=120°C)

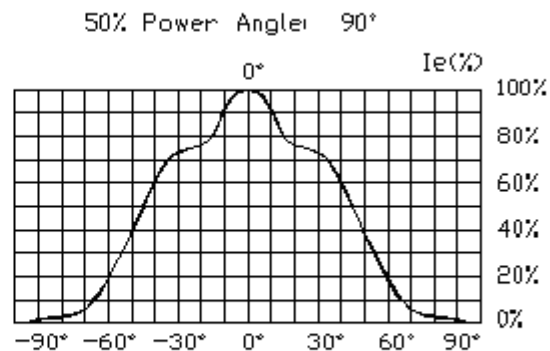

FIG.6 FAR FIELD PATTERN

Mechanical Dimensions

All dimensions are in mm. Tolerance is ± 0.25 mm unless otherwise noted.

An epoxy meniscus may extend about 1.5 mm down the leads.

Burr around bottom of epoxy may be 0.5 mm max.

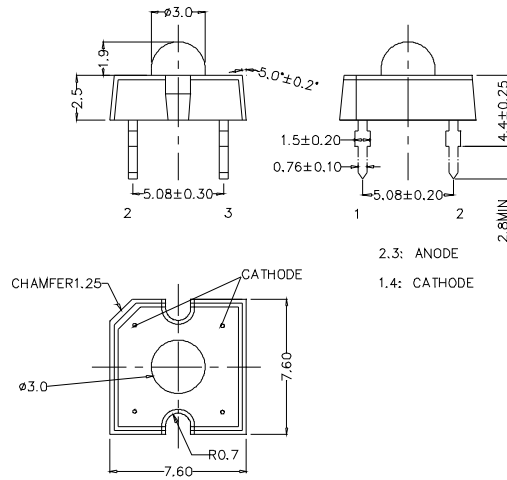

Notes

RoHS Compliance

The levels of environmentally sensitive, persistent biologically toxic (PBT), persistent organic pollutants (POP), or otherwise restricted materials in this product are below the maximum concentration values (also referred to as the threshold limits) permitted for such substances, or are used in an exempted application, in accordance with EU Directive 2002/95/EC on the restriction of the use of certain hazardous substances in electrical and electronic equipment (RoHS), as amended through April 21, 2006.

Vision Advisory Claim

Users should be cautioned not to stare at the light of this LED product. The bright light can damage the eye.

Kit Number System

Cree LED lamps are tested and sorted into performance bins. A bin is specified by ranges of color, forward voltage, and brightness. Sorted LEDs are packaged for shipping in various convenient options. Please refer to the "Cree LED Lamp Packaging Standard" document for more information about shipping and packaging options.

Cree LEDs are sold by order codes in combinations of bins called kits. Order codes are configured in the following manner:

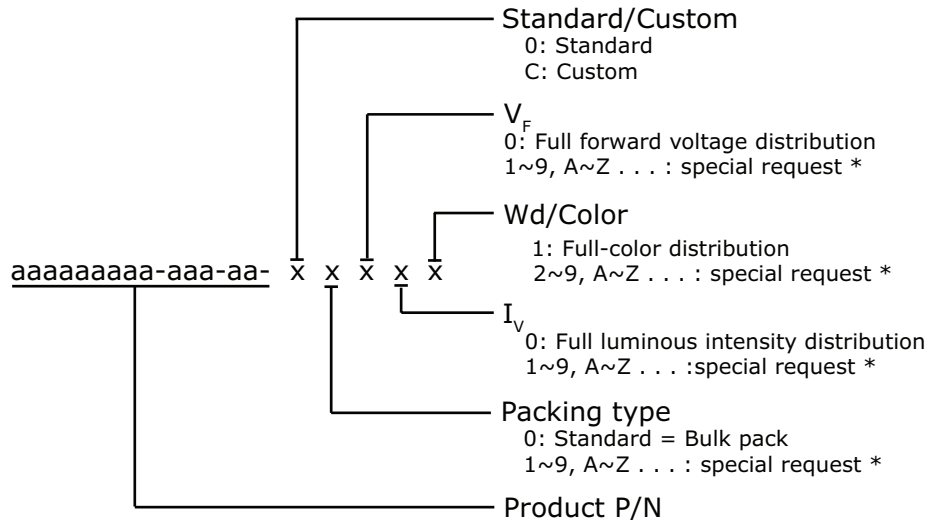

* Contact your Cree sales representative for ordering information.

Standard Available Kits*

Kit Number	Description
LP377FWH1-90G-00001	P4 90 White, FULL RANK, Tube Pack
LP377FWH1-90G-00012	P4 90 White, Consecutive 2 I_V bins of min #L; 2 Consecutive hues of A2,B1,B2, Tube Pack
LP377FWH1-90G-00022	P4 90 White, Consecutive 2 I_V bins of min #M; 2 Consecutive hues of A2,B1,B2, Tube Pack

* Please contact your Cree representative about the availability of non-standard kits.