

## 3-Phase Brushless Sinusoidal Sensorless Motor Driver

### Features

- Automotive AEC-Q100 Qualified, PPAP available upon request
- Position Sensorless BLDC Drivers (no Hall Sensor required)
- 180° Sinusoidal Drive for High Efficiency and Low Acoustic Noise
- Supports 2V to 14V Power Supplies
- Speed Control through Power Supply Modulation (PSM) and/or Pulse-Width Modulation (PWM)
- Built-In Frequency Generator (FG output signal)
- Built-In Lock-Up Protection and Automatic Recovery Circuit (external capacitor not necessary)
- Built-In Overcurrent Limitation (1.5A)
- Built-In Overvoltage Protection
- Built-In Thermal Shutdown Protection
- Thermally Enhanced 8-Lead 4 mm x 4 mm DFN Package with Exposed Pad
- 23 kHz PWM Output Frequency
- No External Tuning Required
- Optimized for Fan Cooling Systems

### Typical Applications

- Silent Notebook CPU/GPU Cooling Fans
- Air Ventilation System
- 12V 3-Phase BLDC Motors

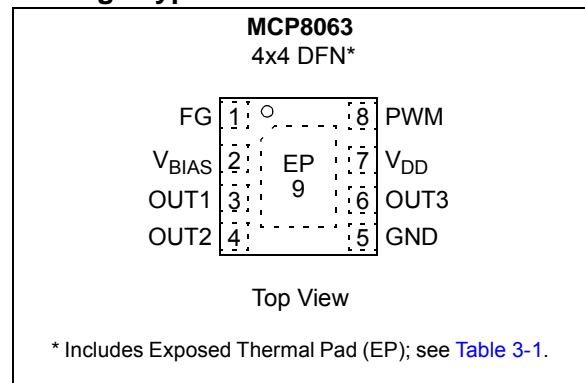
### Description

The MCP8063 device is a highly integrated 3-phase, full-wave sensorless driver for brushless motors. It features a 180° sinusoidal drive, high torque output, and silent drive. Its integrated features and the wide power supply range (2V to 14V) make the MCP8063 an ideal candidate for a broad range of motor characteristics, requiring no external tuning. Speed control can be achieved through either power supply modulation (PSM) or pulse-width modulation (PWM).

Due to the compact packaging and minimum bill of materials (power transistors integrated, no Hall sensor, no external tuning), the MCP8063 is optimized for fan applications that require high efficiency and low acoustic noise at competitive costs. Frequency generator output enables precision speed control in closed-loop applications. The MCP8063 driver includes a Lock-Up Protection mode, which turns off the output current when the motor is under lock condition, and an automatic recovery that enables the fan to restart when the lock condition is removed. Features such as motor overcurrent limitation and thermal shutdown protection improve motor system reliability without additional efforts from design engineers.

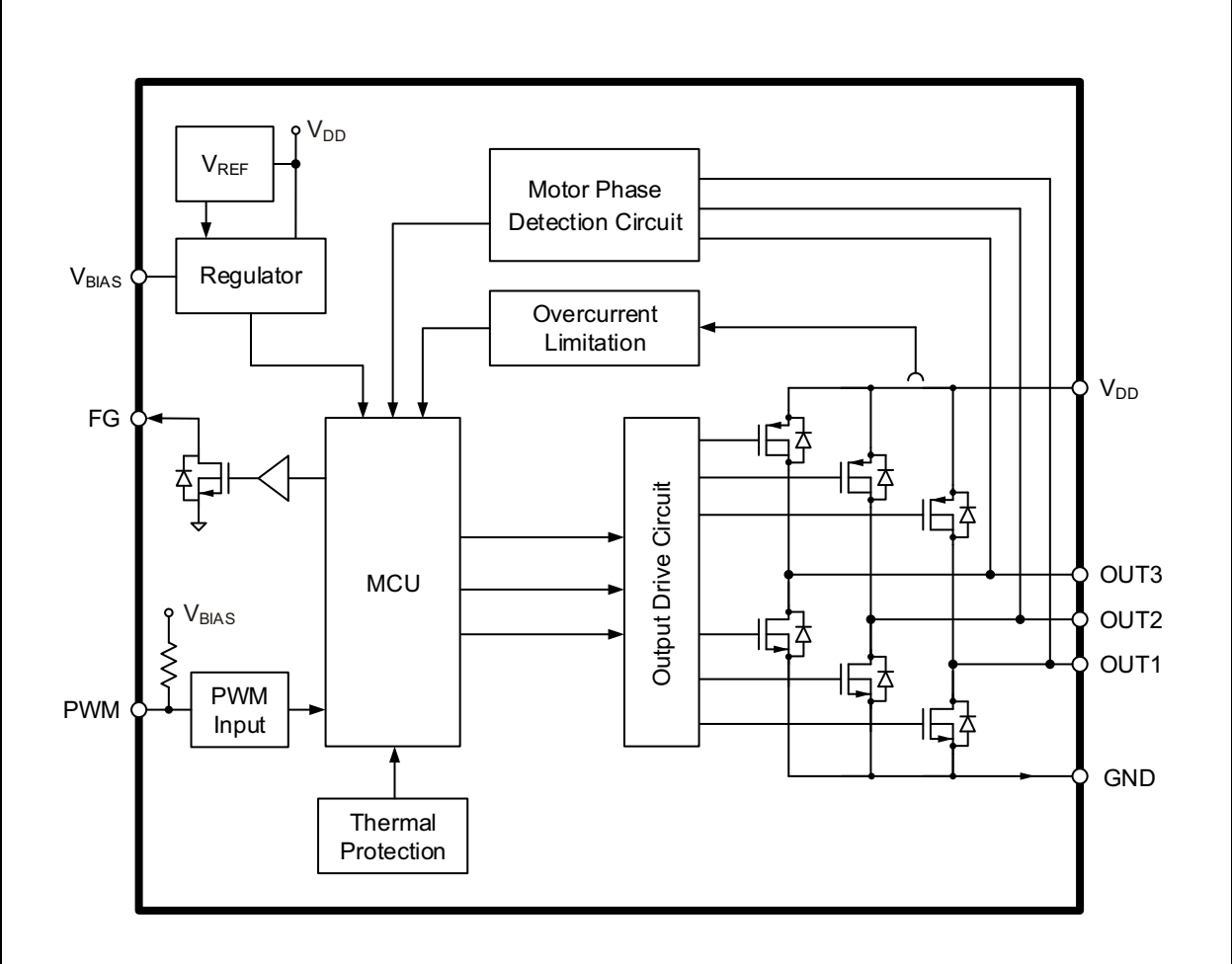
The MCP8063 is available in a compact thermally-enhanced 8-lead 4 mm x 4 mm DFN package with exposed pad.

### Package Types

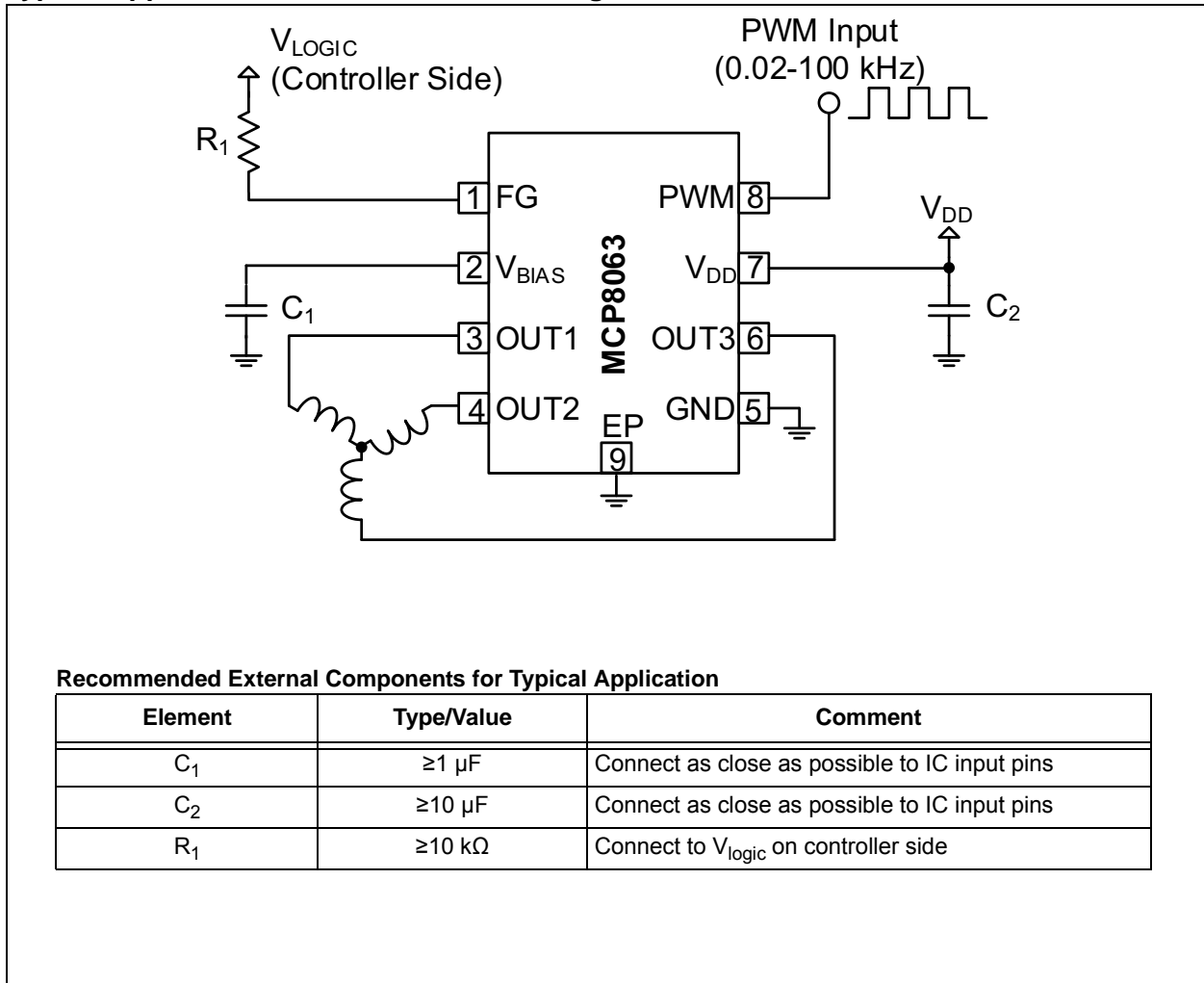


# MCP8063

## Functional Block Diagram



## Typical Application – Fan Motor Driver Using the MCP8063



# MCP8063

## 1.0 ELECTRICAL CHARACTERISTICS

### Absolute Maximum Ratings†

Power Supply Voltage ( $V_{DD\_MAX}$ )	-0.7 to +16.0V
Maximum OUT1,2,3 Voltage ( $V_{OUT\_MAX}$ )	-0.7 to +16.0V
Maximum Output Current <sup>(1)</sup> ( $I_{OUT\_MAX}$ )	-1.7A to +1.7A
FG Maximum Output Voltage ( $V_{FG\_MAX}$ )	-0.7 to +16.0V
FG Maximum Output Current ( $I_{FG\_MAX}$ )	5.0 mA
$V_{BIAS}$ Maximum Voltage ( $V_{BIAS\_MAX}$ )	-0.7 to +4.0V
PWM Maximum Voltage ( $V_{PWM\_MAX}$ )	-0.7 to +4.0V
Maximum Junction Temperature ( $T_J$ )	+150°C
HBM ESD protection on all pins	4 kV

† **Notice:** Stresses above those listed under “Maximum Ratings” may cause permanent damage to the device. This is a stress rating only and functional operation of the device at those or any other conditions above those indicated in the operational listings of this specification is not implied. Exposure to maximum rating conditions for extended periods may affect device reliability.

**Note 1:** OUT1, OUT2, OUT3 (Continuous, 100% duty cycle).

### ELECTRICAL CHARACTERISTICS

**Electrical Specifications:** Unless otherwise specified, all limits are established for  $V_{DD} = 12.0V$ , Temperature = +25°C.

Parameters	Sym.	Min.	Typ.	Max.	Units	Conditions
Power Supply Voltage	$V_{DD}$	2	—	14	V	
Power Supply Current	$I_{VDD}$	—	10	—	mA	Rotation Mode
		—	5	—	mA	Lock-Protection Mode
OUT1/2/3 High Resistance	$R_{ON(H)}$	—	0.6	1	$\Omega$	$I_{OUT} = 0.5A$ , $V_{DD} = 3.3V$ to 14V ( <b>Note 1</b> )
OUT1/2/3 Low Resistance	$R_{ON(L)}$	—	0.6	1	$\Omega$	$I_{OUT} = -0.5A$ , $V_{DD} = 3.3V$ to 14V ( <b>Note 1</b> )
OUT1/2/3 Total Resistance	$R_{ON(H+L)}$	—	1.2	2	$\Omega$	$I_{OUT} = 0.5A$ , $V_{DD} = 3.3V$ to 14V ( <b>Note 1</b> )
OUT1/2/3 Maximum Current Limitation	$I_{OUT\_LIM}$	1.4	1.5	1.6	A	<b>Note 1</b>
$V_{BIAS}$ Output Voltage	$V_{BIAS}$	—	3	—	V	$V_{DD} = 3.3V$ to 14V
		—	$V_{DD} - 0.2$	—	V	$V_{DD} < 3.3V$
PWM Input Frequency	$f_{PWM}$	0.02	—	100	kHz	
PWM Input H Level	$V_{PWM\_H}$	$0.8 \times V_{BIAS}$	—	3.6	V	
PWM Input L Level	$V_{PWM\_L}$	0	—	$0.2 \times V_{BIAS}$	V	
PWM Internal Pull-Up Current	$I_{PWM\_L}$	17	34	—	$\mu A$	PWM = GND, $V_{DD} = 3.3V$ to 14V
		8	17	—	$\mu A$	PWM = GND, $V_{DD} < 3.3V$
PWM Output Frequency	$f_{PWM\_O}$	—	23	—	kHz	
FG Output Pin Low Level Voltage	$V_{OL\_FG}$	—	—	0.25	V	$I_{FG} = -1$ mA
FG Output Pin Leakage Current	$I_{LH\_FG}$	—	—	10	$\mu A$	$V_{FG} = 14V$
Lock Protection Operating Time	$T_{RUN}$	—	0.5	—	s	
Lock Protection Waiting Time	$T_{WAIT}$	4.0	4.5	5.0	s	

**Note 1:** Minimum and maximum parameter is not production tested and is specified by design and validation. Reference PCB, according to JEDEC standard EIA/JESD 51-9.

## ELECTRICAL CHARACTERISTICS (CONTINUED)

**Electrical Specifications:** Unless otherwise specified, all limits are established for  $V_{DD} = 12.0V$ , Temperature =  $+25^{\circ}C$ .

Parameters	Sym.	Min.	Typ.	Max.	Units	Conditions
Thermal Shutdown	$T_{SD}$	—	170	—	$^{\circ}C$	
Thermal Shutdown Hysteresis	$T_{SD\_HYS}$	—	25	—	$^{\circ}C$	
Input Over Voltage	$V_{OV}$	—	18.5	—	V	

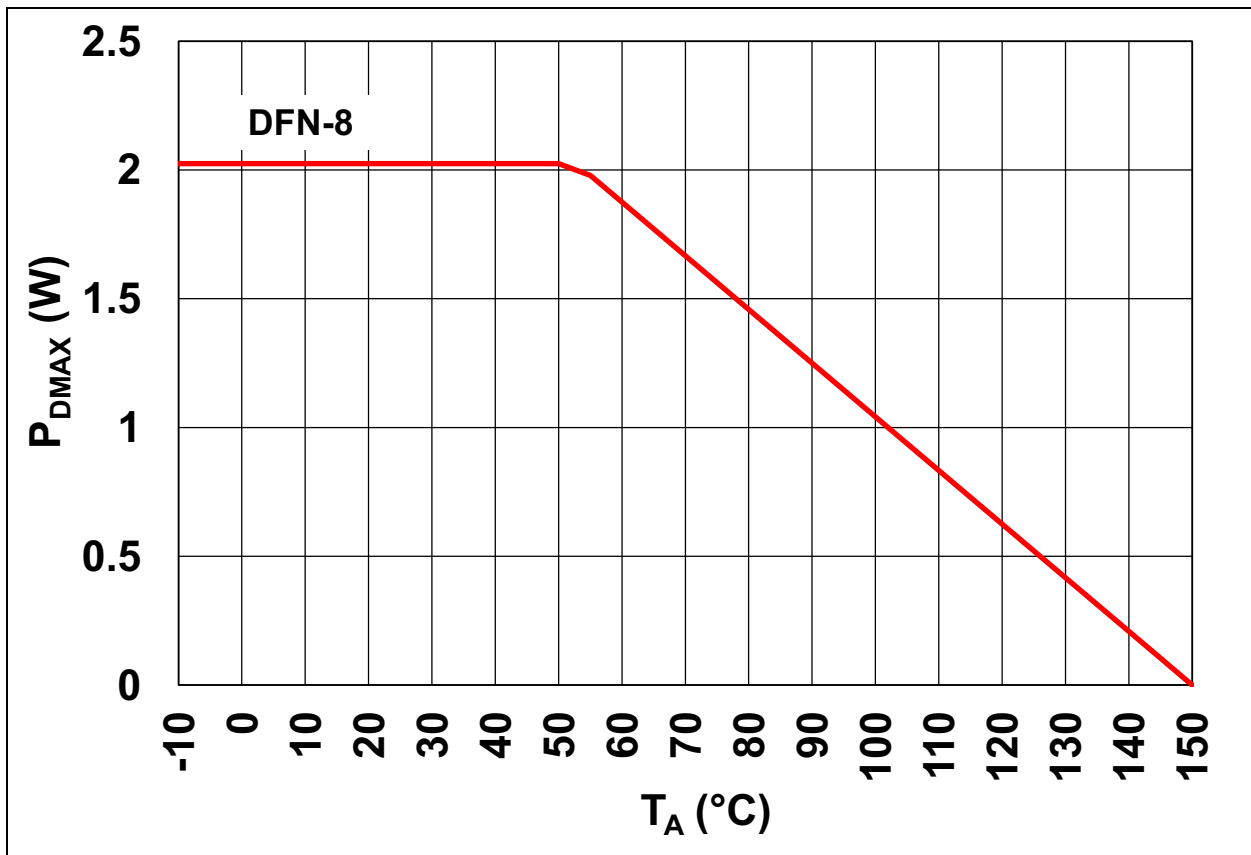
**Note 1:** Minimum and maximum parameter is not production tested and is specified by design and validation. Reference PCB, according to JEDEC standard EIA/JESD 51-9.

## TEMPERATURE SPECIFICATIONS

**Electrical Specifications:** Unless otherwise specified, all limits are established for  $V_{DD} = 12.0V$ ,  $T_A = +25^{\circ}C$ .

Parameters	Sym.	Min.	Typ.	Max.	Units	Conditions
<b>Temperature Ranges</b>						
Operating Temperature	$T_{OPR}$	-40	—	+125	$^{\circ}C$	
Storage Temperature Range	$T_{STG}$	-55	—	+150	$^{\circ}C$	
<b>Package Thermal Resistances</b>						
Thermal Resistance, 8LD 4x4 DFN	$\theta_{JA}$	—	48	—	$^{\circ}C/W$	
	$\theta_{JC}$	—	7	—	$^{\circ}C/W$	

**Note 1:** Minimum and maximum parameter is not production tested and is specified by design and validation. Derating applies for ambient temperatures outside the specified operating range (refer to [Figure 1-1](#)).



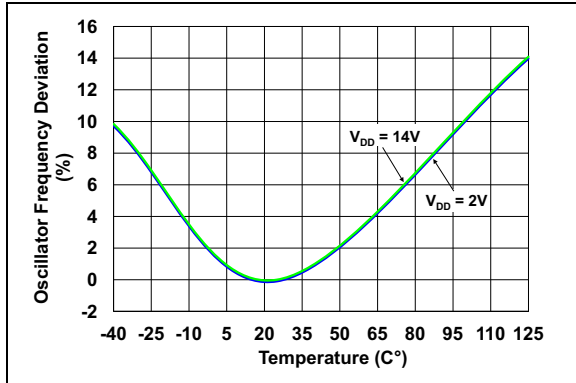
**FIGURE 1-1:** Allowable Power Dissipation ( $P_{D\_MAX}$ ) as a Function of Ambient Temperature ( $T_A$ ).

# MCP8063

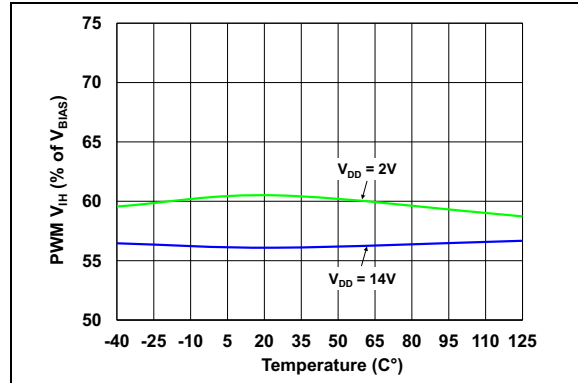
## 2.0 TYPICAL PERFORMANCE CURVES

**Note:** The graphs and tables provided following this note are a statistical summary based on a limited number of samples and are provided for informational purposes only. The performance characteristics listed herein are not tested or guaranteed. In some graphs or tables, the data presented may be outside the specified operating range (e.g., outside specified power supply range) and therefore outside the warranted range.

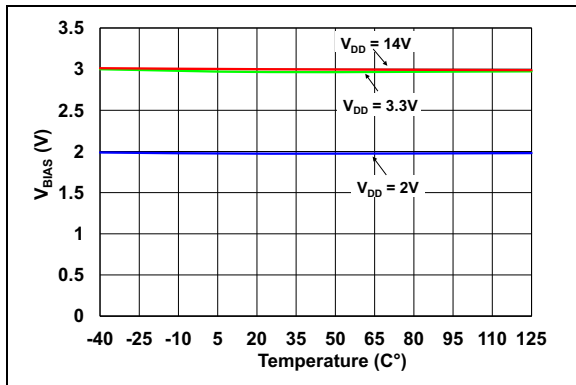
**Note:** Unless otherwise indicated,  $T_A = +25^\circ\text{C}$ ,  $V_{DD} = 14\text{V}$ , OUT1, 2, 3 and PWM open.



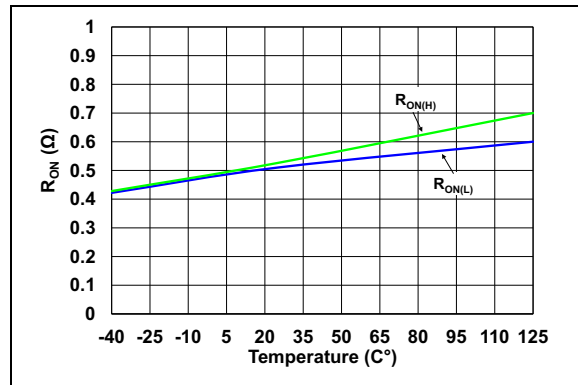
**FIGURE 2-1:** Oscillator Frequency Deviation vs. Temperature.



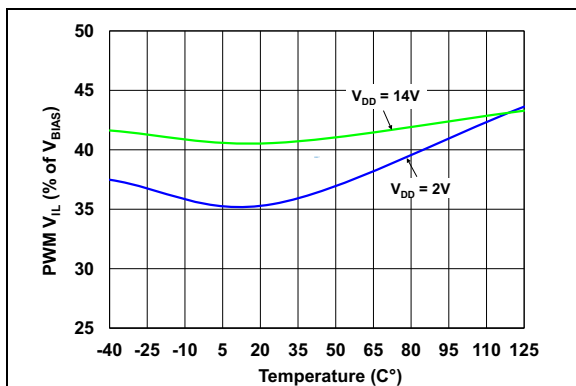
**FIGURE 2-4:** Input (PWM)  $V_{IH}$  vs. Temperature.



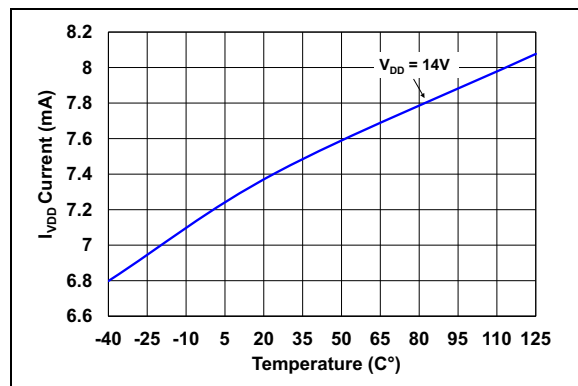
**FIGURE 2-2:** Internal Regulated Voltage ( $V_{BIAS}$ ) vs. Temperature.



**FIGURE 2-5:** Output  $R_{ON}$  Resistance vs. Temperature ( $V_{DD} = 3.3\text{V}$ ).

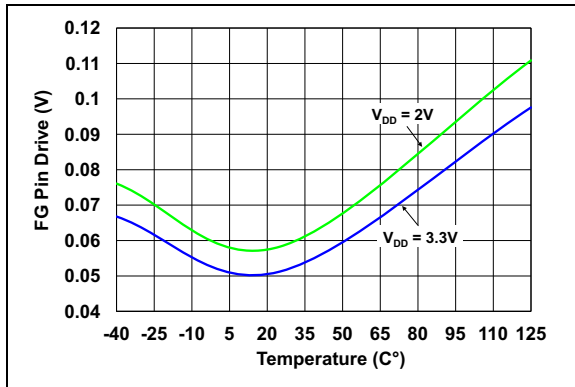


**FIGURE 2-3:** Input (PWM)  $V_{IL}$  vs. Temperature.

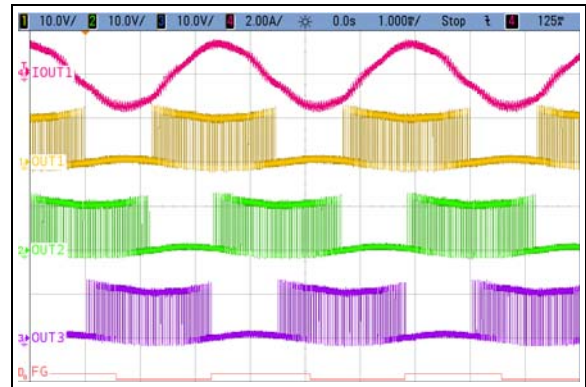


**FIGURE 2-6:** Supply Current vs. Temperature.

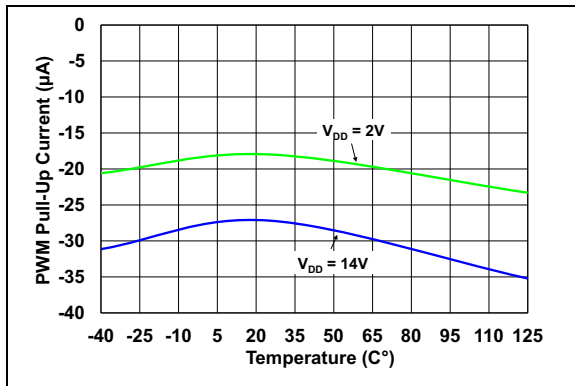
**Note:** Unless otherwise indicated,  $T_A = +25^\circ\text{C}$ ,  $V_{DD} = 14\text{V}$ , OUT1, 2, 3 and PWM open.



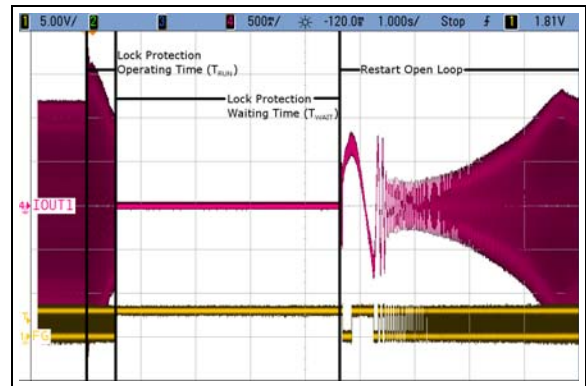
**FIGURE 2-7:** FG Output Pin Low Level Voltage ( $I_{FG} = -1\text{ mA}$ ).



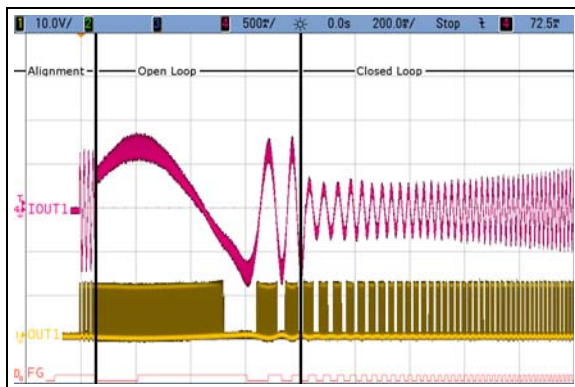
**FIGURE 2-10:** Typical Outputs on Closed Loop.



**FIGURE 2-8:** PWM Pull-Up Current vs. Temperature.



**FIGURE 2-11:** Typical Rotor Lock Situation.



**FIGURE 2-9:** Typical Output on Start-Up.

# MCP8063

---

## 3.0 PIN DESCRIPTIONS

The descriptions of the pins are listed in [Table 3-1](#).

**TABLE 3-1: MCP8063 PIN FUNCTION TABLE**

MCP8063	Symbol	Type	Description
4x4 DFN			
1	FG	O	Motor Speed Indication Output Pin
2	V <sub>BIAS</sub>	P	Internal Regulator Output Pin (for decoupling only)
3	OUT1	O	Single-Phase Coil Output Pin
4	OUT2	O	Single-Phase Coil Output Pin
5	GND	P	Negative Voltage Supply Pin (Ground)
6	OUT3	O	Single-Phase Coil Output Pin
7	V <sub>DD</sub>	P	Positive Voltage Supply for Motor Driver Pin
8	PWM	I	PWM Input Signal for Speed Control Pin
9	EP	P	Exposed pad is used for thermal dissipation. Connect to GND.

**Legend:** I = Input; O = Output; P = Power



## 4.0 FUNCTIONAL DESCRIPTION

The MCP8063 device generates a full-wave signal to drive a 3-phase sensorless BLDC motor. High efficiency and low power consumption are achieved due to DMOS transistors and synchronous rectification drive type. The current carrying order of the output is as follows: OUT1 → OUT2 → OUT3.

### 4.1 Speed Control

The rotational speed of the motor can be controlled either through the PWM digital input signal or by varying the power supply ( $V_{DD}$ ). When the PWM signal is “High” (or left open), the motor rotates at full speed. When the PWM signal is “Low”, the motor is stopped (and the driver outputs are set to high impedance). By changing the PWM duty cycle, the speed can be adjusted. Notice that the PWM frequency has no special meaning for the motor speed and is asynchronous with the activation of the output transistors. Thus, the user has maximum freedom to choose the PWM system frequency within a wide range (from 20 Hz to 100 kHz), while the output transistor activation always occurs at a fixed rate, which is outside the range of audible frequencies. The typical output frequency of MCP8063 is 23 kHz.

### 4.2 Frequency Generator Function

The Frequency Generator output is a “Hall-sensor equivalent” digital output, giving information to an external controller about the speed and phase of the motor. The FG pin is an open-drain output, connecting to a logical voltage level through an external pull-up resistor. When a lock (or out-of-sync) situation is detected by the driver, this output is set to high impedance until the motor is restarted. Leave the pin open when not used. The FG signal can be used to compute the motor speed in rotations per minute (RPM). Typically, for a four-pole BLDC fan (4P/6S), the speed in RPMs is  $30 \times \text{FG frequency (Hz)}$ .

#### EQUATION 1-1:

$$\frac{FG \times 720}{(P \times S)} = \text{Rotor speed RPM}$$

Where:

- P = Total number of poles in the motor
- S = Total number of slots in the motor

### 4.3 Lock-Up Protection and Automatic Restart

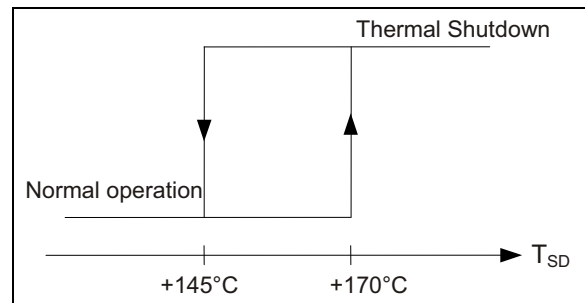
If the motor is stopped (blocked) or if it loses synchronization with the driver, a lock-up protection circuit detects this situation and ties the outputs to GND in order to dissipate the remaining energy from the rotor with a minimum of self heating. After a “waiting time” ( $T_{WAIT}$ ), the lock-up protection is released and normal operation resumes for a given time ( $T_{RUN}$ ). In case the motor is still blocked, a new period of waiting time is started.  $T_{WAIT}$  and  $T_{RUN}$  timings are fixed internally, so that no external capacitor is needed.

### 4.4 Overcurrent Limitation

The motor peak current is limited by the driver to a fixed value (defined internally), thus limiting the maximum power dissipation in the coils.

### 4.5 Thermal Shutdown

The MCP8063 device has a thermal protection function which detects when the die temperature exceeds  $T_{SD} = +170^{\circ}\text{C}$ . When this temperature is reached, the circuit enters Thermal Shutdown mode and the outputs OUT1, OUT2 and OUT3 are tied to GND in order to dissipate the remaining energy from the rotor with a minimum of self-heating. Once the junction temperature ( $T_{SD}$ ) has dropped below  $+145^{\circ}\text{C}$ , the normal operation resumes (the thermal detection circuit has  $+25^{\circ}\text{C}$  hysteresis function).



**FIGURE 4-1:** Thermal Protection Hysteresis.

### 4.6 Internal Voltage Regulator

$V_{BIAS}$  voltage is generated internally and is used to supply internal logical blocks. The  $V_{BIAS}$  pin is used to connect an external decoupling capacitor (1  $\mu\text{F}$  or higher). Notice that this pin is for IC internal use and is not designed to supply DC current to external blocks.

### 4.7 Overvoltage Shutdown

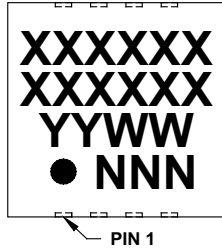
The MCP8063 device has an overvoltage protection function which detects when the  $V_{DD}$  voltage exceeds  $V_{OV} = +18.5\text{V}$ . When this temperature is reached, the circuit enters Thermal Shutdown mode, and outputs OUT1, OUT2 and OUT3 are disabled (high impedance).

# MCP8063

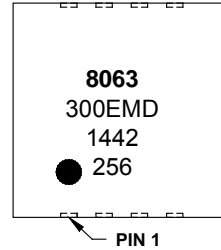
## 5.0 PACKAGING INFORMATION

### 5.1 Package Marking Information

8-Lead DFN (4x4x0.9 mm)



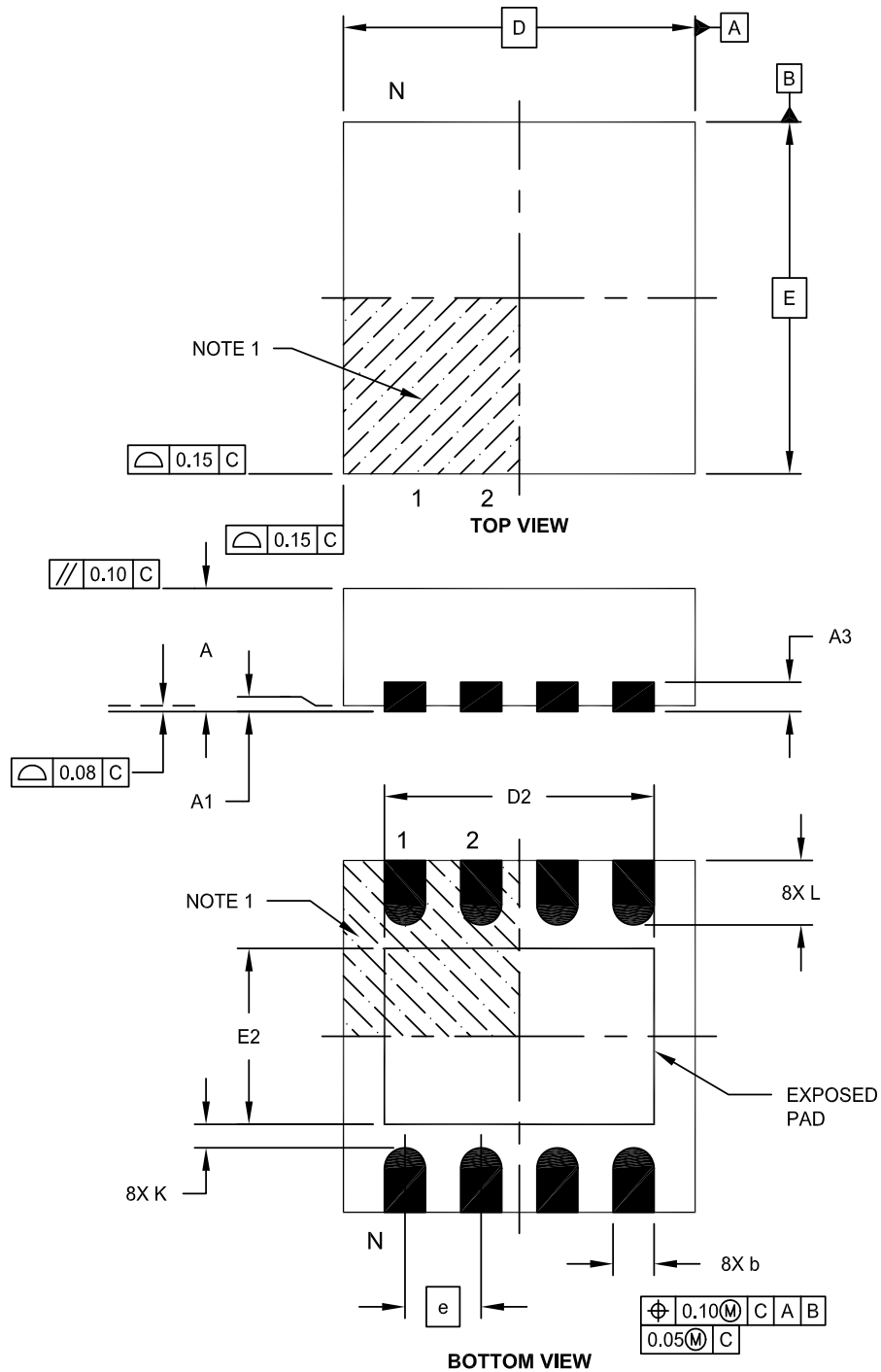
Example



<b>Legend:</b>	XX...X	Customer-specific information
	Y	Year code (last digit of calendar year)
	YY	Year code (last 2 digits of calendar year)
	WW	Week code (week of January 1 is week '01')
	NNN	Alphanumeric traceability code
	(e3)	Pb-free JEDEC® designator for Matte Tin (Sn)
	*	This package is Pb-free. The Pb-free JEDEC designator (e3) can be found on the outer packaging for this package.
<b>Note:</b>	In the event the full Microchip part number cannot be marked on one line, it will be carried over to the next line, thus limiting the number of available characters for customer-specific information.	

## 8-Lead Plastic Dual Flat, No Lead Package (MD) – 4x4x0.9 mm Body [DFN]

**Note:** For the most current package drawings, please see the Microchip Packaging Specification located at <http://www.microchip.com/packaging>

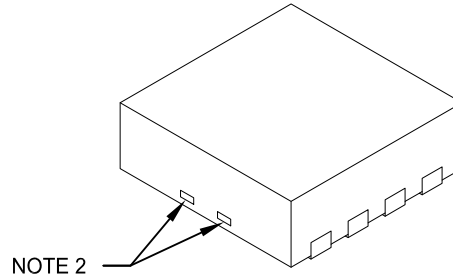


Microchip Technology Drawing C04-131E Sheet 1 of 2

# MCP8063

## 8-Lead Plastic Dual Flat, No Lead Package (MD) – 4x4x0.9 mm Body [DFN]

**Note:** For the most current package drawings, please see the Microchip Packaging Specification located at <http://www.microchip.com/packaging>



Dimension Limits	Units	MILLIMETERS		
		MIN	NOM	MAX
Number of Pins	N	8		
Pitch	e	0.80 BSC		
Overall Height	A	0.80	0.90	1.00
Standoff	A1	0.00	0.02	0.05
Contact Thickness	A3	0.20 REF		
Overall Length	D	4.00 BSC		
Exposed Pad Width	E2	2.60	2.70	2.80
Overall Width	E	4.00 BSC		
Exposed Pad Length	D2	3.40	3.50	3.60
Contact Width	b	0.25	0.30	0.35
Contact Length	L	0.30	0.40	0.50
Contact-to-Exposed Pad	K	0.20	-	-

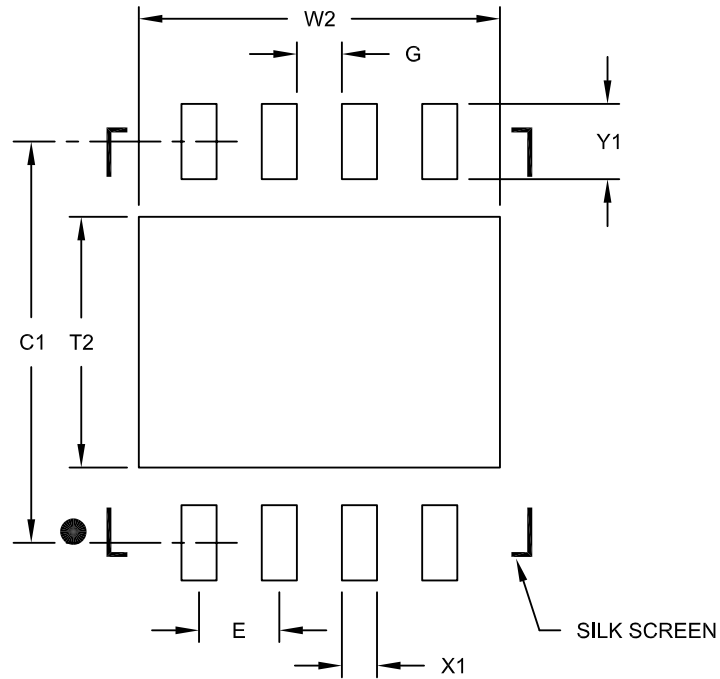
**Notes:**

1. Pin 1 visual index feature may vary, but must be located within the hatched area.
2. Package may have one or more exposed tie bars at ends.
3. Package is saw singulated
4. Dimensioning and tolerancing per ASME Y14.5M  
BSC: Basic Dimension. Theoretically exact value shown without tolerances.  
REF: Reference Dimension, usually without tolerance, for information purposes only.

Microchip Technology Drawing C04-131E Sheet 2 of 2

## 8-Lead Plastic Dual Flat, No Lead Package (MD) - 4x4x0.9 mm Body [DFN]

**Note:** For the most current package drawings, please see the Microchip Packaging Specification located at <http://www.microchip.com/packaging>



### RECOMMENDED LAND PATTERN

Dimension Limits	Units	MILLIMETERS		
		MIN	NOM	MAX
Contact Pitch	E	0.80 BSC		
Optional Center Pad Width	W2			3.60
Optional Center Pad Length	T2			2.50
Contact Pad Spacing	C1	4.00		
Contact Pad Width (X8)	X1			0.35
Contact Pad Length (X8)	Y1			0.75
Distance Between Pads	G	0.45		

**Notes:**

1. Dimensioning and tolerancing per ASME Y14.5M

BSC: Basic Dimension. Theoretically exact value shown without tolerances.

Microchip Technology Drawing No. C04-2131C

# MCP8063

---

NOTES:

## APPENDIX A: REVISION HISTORY

### Revision B (November 2014)

The following is the list of modifications:

1. Changed FG Maximum Output Voltage values under [Absolute Maximum Ratings†](#) section
2. Changed Power Supply Voltage value under [Absolute Maximum Ratings†](#) section.
3. Added Input Overvoltage Value in [Electrical Characteristics](#) table.
4. Minor typographical corrections.

### Revision A (February 2014)

- Original Release of this Document.

# MCP8063

---

NOTES:



## PRODUCT IDENTIFICATION SYSTEM

To order or obtain information, e.g., on pricing or delivery, refer to the factory or the listed sales office.

<u>PART NO.</u>	<u>X</u>	<u>-X</u>	<u>/XX</u>
Device	Tube/Tape and Reel	Temperature Range	Package
<b>Device:</b> MCP8063: 3-Phase BLDC Sinusoidal Sensorless Motor Driver MCP8063T: 3-Phase BLDC Sinusoidal Sensorless Motor Driver (Tape and Reel)			
<b>Temperature Range:</b> E = -40°C to +125°C (Extended)			
<b>Package:</b> MD = 8-Lead Plastic Dual Flat, No Lead – 4x4x0.9 mm Body (DFN)			

**Examples:**

a) MCP8063-E/MD: Extended temperature, 8LD 4x4 DFN package

b) MCP8063T-E/MD: Extended temperature, 8LD 4x4 DFN package, Tape and Reel

# MCP8063

---

NOTES:

---

**Note the following details of the code protection feature on Microchip devices:**

- Microchip products meet the specification contained in their particular Microchip Data Sheet.
- Microchip believes that its family of products is one of the most secure families of its kind on the market today, when used in the intended manner and under normal conditions.
- There are dishonest and possibly illegal methods used to breach the code protection feature. All of these methods, to our knowledge, require using the Microchip products in a manner outside the operating specifications contained in Microchip's Data Sheets. Most likely, the person doing so is engaged in theft of intellectual property.
- Microchip is willing to work with the customer who is concerned about the integrity of their code.
- Neither Microchip nor any other semiconductor manufacturer can guarantee the security of their code. Code protection does not mean that we are guaranteeing the product as “unbreakable.”

Code protection is constantly evolving. We at Microchip are committed to continuously improving the code protection features of our products. Attempts to break Microchip's code protection feature may be a violation of the Digital Millennium Copyright Act. If such acts allow unauthorized access to your software or other copyrighted work, you may have a right to sue for relief under that Act.

---

Information contained in this publication regarding device applications and the like is provided only for your convenience and may be superseded by updates. It is your responsibility to ensure that your application meets with your specifications. MICROCHIP MAKES NO REPRESENTATIONS OR WARRANTIES OF ANY KIND WHETHER EXPRESS OR IMPLIED, WRITTEN OR ORAL, STATUTORY OR OTHERWISE, RELATED TO THE INFORMATION, INCLUDING BUT NOT LIMITED TO ITS CONDITION, QUALITY, PERFORMANCE, MERCHANTABILITY OR FITNESS FOR PURPOSE. Microchip disclaims all liability arising from this information and its use. Use of Microchip devices in life support and/or safety applications is entirely at the buyer's risk, and the buyer agrees to defend, indemnify and hold harmless Microchip from any and all damages, claims, suits, or expenses resulting from such use. No licenses are conveyed, implicitly or otherwise, under any Microchip intellectual property rights.

**Trademarks**

The Microchip name and logo, the Microchip logo, dsPIC, FlashFlex, flexPWR, JukeBlox, KEELOQ, KEELOQ logo, Kleer, LANCheck, MediaLB, MOST, MOST logo, MPLAB, OptoLyzer, PIC, PICSTART, PIC<sup>32</sup> logo, RightTouch, SpyNIC, SST, SST Logo, SuperFlash and UNI/O are registered trademarks of Microchip Technology Incorporated in the U.S.A. and other countries.

The Embedded Control Solutions Company and mTouch are registered trademarks of Microchip Technology Incorporated in the U.S.A.

Analog-for-the-Digital Age, BodyCom, chipKIT, chipKIT logo, CodeGuard, dsPICDEM, dsPICDEM.net, ECAN, In-Circuit Serial Programming, ICSP, Inter-Chip Connectivity, KleerNet, KleerNet logo, MiWi, MPASM, MPF, MPLAB Certified logo, MPLIB, MPLINK, MultiTRAK, NetDetach, Omniscient Code Generation, PICDEM, PICDEM.net, PICkit, PICtail, RightTouch logo, REAL ICE, SQI, Serial Quad I/O, Total Endurance, TSHARC, USBCheck, VariSense, ViewSpan, WiperLock, Wireless DNA, and ZENA are trademarks of Microchip Technology Incorporated in the U.S.A. and other countries.

SQTP is a service mark of Microchip Technology Incorporated in the U.S.A.

Silicon Storage Technology is a registered trademark of Microchip Technology Inc. in other countries.

GestIC is a registered trademarks of Microchip Technology Germany II GmbH & Co. KG, a subsidiary of Microchip Technology Inc., in other countries.

All other trademarks mentioned herein are property of their respective companies.

© 2014, Microchip Technology Incorporated, Printed in the U.S.A., All Rights Reserved.

ISBN: 978-1-63276-791-2

**QUALITY MANAGEMENT SYSTEM**  
**CERTIFIED BY DNV**  
**== ISO/TS 16949 ==**

*Microchip received ISO/TS-16949:2009 certification for its worldwide headquarters, design and wafer fabrication facilities in Chandler and Tempe, Arizona; Gresham, Oregon and design centers in California and India. The Company's quality system processes and procedures are for its PIC<sup>®</sup> MCUs and dsPIC<sup>®</sup> DSCs, KEELOQ<sup>®</sup> code hopping devices, Serial EEPROMs, microperipherals, nonvolatile memory and analog products. In addition, Microchip's quality system for the design and manufacture of development systems is ISO 9001:2000 certified.*



# MICROCHIP

## Worldwide Sales and Service

### AMERICAS

**Corporate Office**  
2355 West Chandler Blvd.  
Chandler, AZ 85224-6199  
Tel: 480-792-7200  
Fax: 480-792-7277  
Technical Support:  
<http://www.microchip.com/support>  
Web Address:  
[www.microchip.com](http://www.microchip.com)

**Atlanta**  
Duluth, GA  
Tel: 678-957-9614  
Fax: 678-957-1455

**Austin, TX**  
Tel: 512-257-3370

**Boston**  
Westborough, MA  
Tel: 774-760-0087  
Fax: 774-760-0088

**Chicago**  
Itasca, IL  
Tel: 630-285-0071  
Fax: 630-285-0075

**Cleveland**  
Independence, OH  
Tel: 216-447-0464  
Fax: 216-447-0643

**Dallas**  
Addison, TX  
Tel: 972-818-7423  
Fax: 972-818-2924

**Detroit**  
Novi, MI  
Tel: 248-848-4000

**Houston, TX**  
Tel: 281-894-5983

**Indianapolis**  
Noblesville, IN  
Tel: 317-773-8323  
Fax: 317-773-5453

**Los Angeles**  
Mission Viejo, CA  
Tel: 949-462-9523  
Fax: 949-462-9608

**New York, NY**  
Tel: 631-435-6000

**San Jose, CA**  
Tel: 408-735-9110

**Canada - Toronto**  
Tel: 905-673-0699  
Fax: 905-673-6509

### ASIA/PACIFIC

**Asia Pacific Office**  
Suites 3707-14, 37th Floor  
Tower 6, The Gateway  
Harbour City, Kowloon  
Hong Kong  
Tel: 852-2943-5100  
Fax: 852-2401-3431

**Australia - Sydney**  
Tel: 61-2-9868-6733  
Fax: 61-2-9868-6755

**China - Beijing**  
Tel: 86-10-8569-7000  
Fax: 86-10-8528-2104

**China - Chengdu**  
Tel: 86-28-8665-5511  
Fax: 86-28-8665-7889

**China - Chongqing**  
Tel: 86-23-8980-9588  
Fax: 86-23-8980-9500

**China - Hangzhou**  
Tel: 86-571-8792-8115  
Fax: 86-571-8792-8116

**China - Hong Kong SAR**  
Tel: 852-2943-5100  
Fax: 852-2401-3431

**China - Nanjing**  
Tel: 86-25-8473-2460  
Fax: 86-25-8473-2470

**China - Qingdao**  
Tel: 86-532-8502-7355  
Fax: 86-532-8502-7205

**China - Shanghai**  
Tel: 86-21-5407-5533  
Fax: 86-21-5407-5066

**China - Shenyang**  
Tel: 86-24-2334-2829  
Fax: 86-24-2334-2393

**China - Shenzhen**  
Tel: 86-755-8864-2200  
Fax: 86-755-8203-1760

**China - Wuhan**  
Tel: 86-27-5980-5300  
Fax: 86-27-5980-5118

**China - Xian**  
Tel: 86-29-8833-7252  
Fax: 86-29-8833-7256

**China - Xiamen**  
Tel: 86-592-2388138  
Fax: 86-592-2388130

**China - Zhuhai**  
Tel: 86-756-3210040  
Fax: 86-756-3210049

### ASIA/PACIFIC

**India - Bangalore**  
Tel: 91-80-3090-4444  
Fax: 91-80-3090-4123

**India - New Delhi**  
Tel: 91-11-4160-8631  
Fax: 91-11-4160-8632

**India - Pune**  
Tel: 91-20-3019-1500

**Japan - Osaka**  
Tel: 81-6-6152-7160  
Fax: 81-6-6152-9310

**Japan - Tokyo**  
Tel: 81-3-6880-3770  
Fax: 81-3-6880-3771

**Korea - Daegu**  
Tel: 82-53-744-4301  
Fax: 82-53-744-4302

**Korea - Seoul**  
Tel: 82-2-554-7200  
Fax: 82-2-558-5932 or  
82-2-558-5934

**Malaysia - Kuala Lumpur**  
Tel: 60-3-6201-9857  
Fax: 60-3-6201-9859

**Malaysia - Penang**  
Tel: 60-4-227-8870  
Fax: 60-4-227-4068

**Philippines - Manila**  
Tel: 63-2-634-9065  
Fax: 63-2-634-9069

**Singapore**  
Tel: 65-6334-8870  
Fax: 65-6334-8850

**Taiwan - Hsin Chu**  
Tel: 886-3-5778-366  
Fax: 886-3-5770-955

**Taiwan - Kaohsiung**  
Tel: 886-7-213-7830

**Taiwan - Taipei**  
Tel: 886-2-2508-8600  
Fax: 886-2-2508-0102

**Thailand - Bangkok**  
Tel: 66-2-694-1351  
Fax: 66-2-694-1350

### EUROPE

**Austria - Wels**  
Tel: 43-7242-2244-39  
Fax: 43-7242-2244-393

**Denmark - Copenhagen**  
Tel: 45-4450-2828  
Fax: 45-4485-2829

**France - Paris**  
Tel: 33-1-69-53-63-20  
Fax: 33-1-69-30-90-79

**Germany - Dusseldorf**  
Tel: 49-2129-3766400

**Germany - Munich**  
Tel: 49-89-627-144-0  
Fax: 49-89-627-144-44

**Germany - Pforzheim**  
Tel: 49-7231-424750

**Italy - Milan**  
Tel: 39-0331-742611  
Fax: 39-0331-466781

**Italy - Venice**  
Tel: 39-049-7625286

**Netherlands - Drunen**  
Tel: 31-416-690399  
Fax: 31-416-690340

**Poland - Warsaw**  
Tel: 48-22-3325737

**Spain - Madrid**  
Tel: 34-91-708-08-90  
Fax: 34-91-708-08-91

**Sweden - Stockholm**  
Tel: 46-8-5090-4654

**UK - Wokingham**  
Tel: 44-118-921-5800  
Fax: 44-118-921-5820

03/25/14

# Mouser Electronics

Authorized Distributor

Click to View Pricing, Inventory, Delivery & Lifecycle Information:

[Microchip:](#)

[MCP8063-E/MD](#) [MCP8063T-E/MD](#)