

# NCC Series

## Surface Mount Common Mode Chokes



### FEATURES

- HIGH COMMON MODE IMPEDANCE AT HIGH FREQUENCY
- LOW PROFILE SURFACE MOUNT PACKAGE
- SHIELDED PROVIDING EXCELLENT NOISE SUPPRESSION
- SUITABLE FOR HIGH SPEED DIGITAL EQUIPMENT (USB/IEEE)
- Pb-FREE CONSTRUCTION
- BOTH FLOW AND REFLOW SOLDERING APPLICABLE

**RoHS  
Compliant**

includes all homogeneous materials

\*See Part Number System for Details

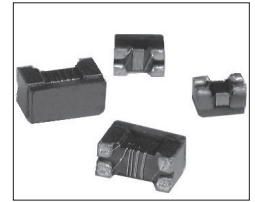

### CHARACTERISTICS

Case Size	0805	1206	1210	1812
Impedance Range	30~ 370 Ohms	30 ~ 2,200 Ohms	90 ~ 1,000 Ohms	90 ~ 2,800 Ohms
Available Tolerance	±25%			
Temperature Range	-40°C ~ +125°C			
Withstanding voltage	125VDC 30 seconds			
Insulation Resistance	10MΩ after application 50V for 30 seconds			
Resistance to Solder Heat	260°C ±5°C for 10 seconds			
Temperature Cycling	±25% of initial value after 10 cycles (-40°C/+20°C/+125°C/+20°C)			

### PART NUMBER SYSTEM

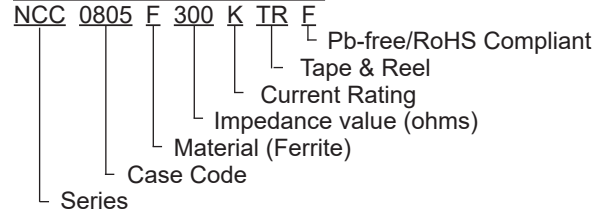

### NCC0805 SPECIFICATIONS

NIC Part Number	Impedance (Ω)	Test Frequency (MHz)	DC Resistance (Ω max.)	DC Current (mA max.)	Voltage Rating (Vdc)	Withstanding Voltage (Vdc)	Insulation Resistance (Ω)
NCC0805F300KTRF	30 ±25%	100	0.20	400	50	125	10Meg
NCC0805F670KTRF	67 ±25%		0.25	400			
NCC0805F900KTRF	90 ±25%		0.30	400			
NCC0805F121KTRF	120 ±25%		0.30	400			
NCC0805F161JTRF	160 ±25%		0.35	350			
NCC0805F181JTRF	180 ±25%		0.35	350			
NCC0805F221HTRF	220 ±25%		0.40	300			
NCC0805F221MTRF	220 ±25%		0.40	600			
NCC0805F261HTRF	260 ±25%		0.40	300			
NCC0805F301HTRF	300 ±25%		0.45	300			
NCC0805F361FTRF	360 ±25%		0.50	100			
NCC0805F371FTRF	370 ±25%		0.50	100			

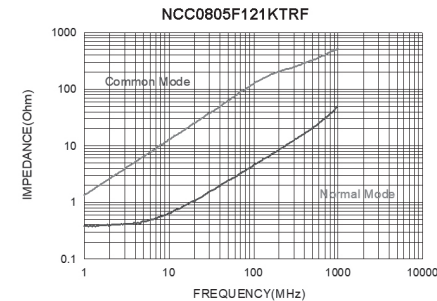
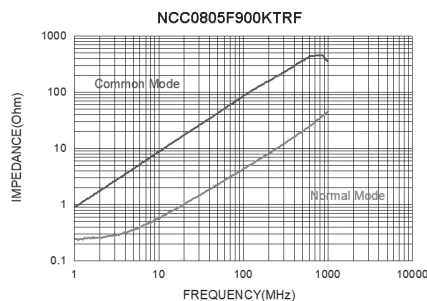
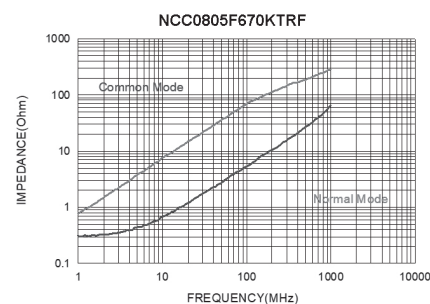
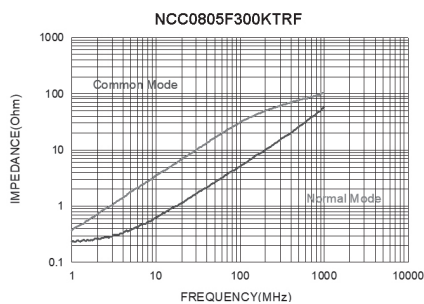

Performance Passives By Design

NIC Components Corp.  
100 Baylis Road, Melville, NY 11747

Page 1

www.niccomp.com

Last Updated: 03-20-2023. Specification subject to change without notice. Please check web site for latest information.

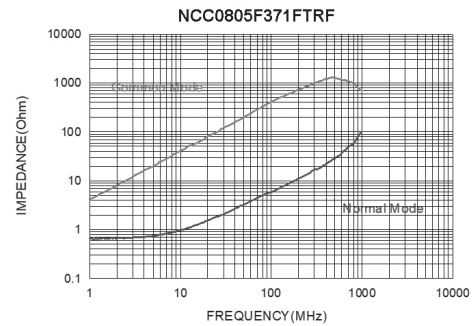
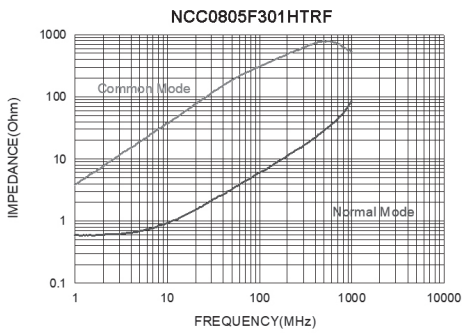
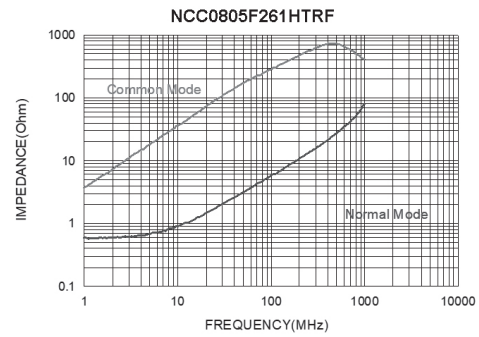
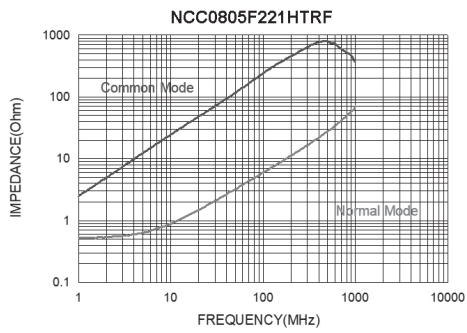
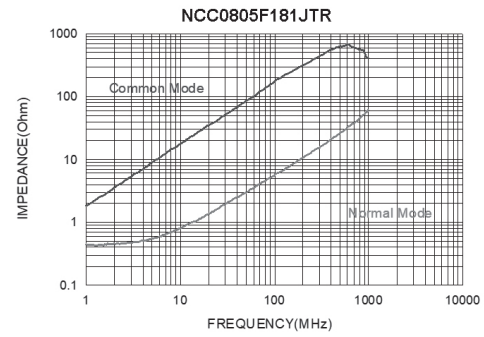
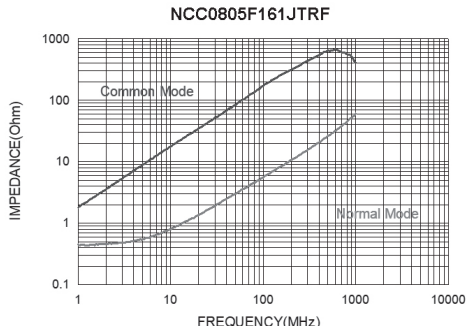



**NCC1206 SPECIFICATIONS**

NIC Part Number	Impedance (Ω)	Test Frequency (MHz)	DC Resistance (Ω max.)	DC Current (mA max.)	Voltage Rating (Vdc)	Withstanding Voltage (Vdc)	Insulation Resistance (Ω)
NCC1206F300KTRF	30 ±25%	100	0.20	400	50	125	10Meg
NCC1206F670KTRF	67 ±25%		0.30	400			
NCC1206F800KTRF	80 ±25%		0.30	400			
NCC1206F900KTRF	90 ±25%		0.30	400			
NCC1206F121KTRF	120 ±25%		0.30	400			
NCC1206F161JTRF	160 ±25%		0.35	350			
NCC1206F181JTRF	180 ±25%		0.35	350			
NCC1206F221HTRF	220 ±25%		0.45	300			
NCC1206F261HTRF	260 ±25%		0.45	300			
NCC1206F281HTRF	280 ±25%		0.45	300			
NCC1206F301HTRF	300 ±25%		0.50	300			
NCC1206F361HTRF	360 ±25%		0.60	300			
NCC1206F431HTRF	430 ±25%		0.60	300			
NCC1206F471HTRF	470 ±25%		0.70	300			
NCC1206F551HTRF	550 ±25%		0.75	300			
NCC1206F601HTRF	600 ±25%		0.80	300			
NCC1206F222GTRF	2200 ±25%		1.20	200			

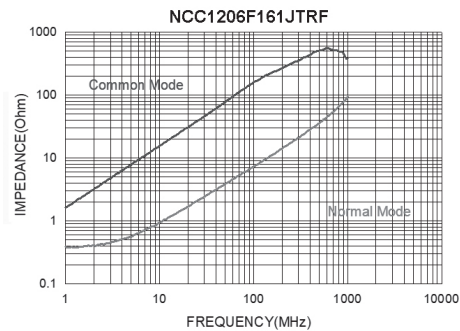
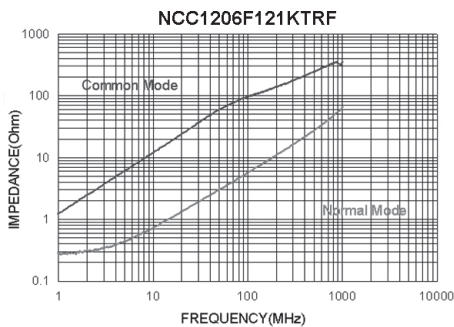
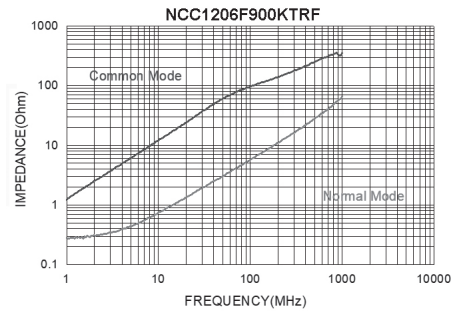
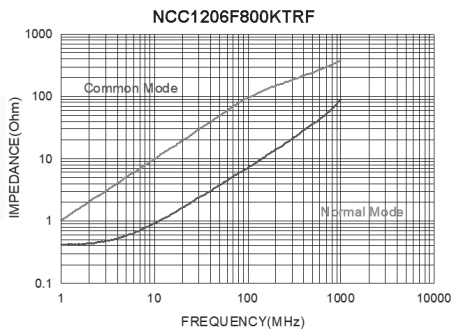
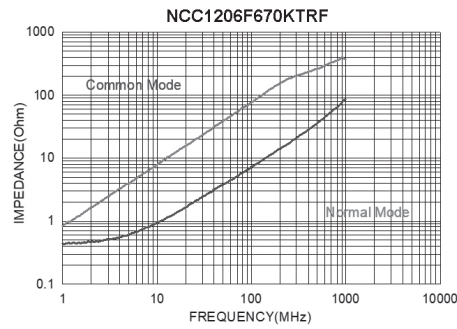
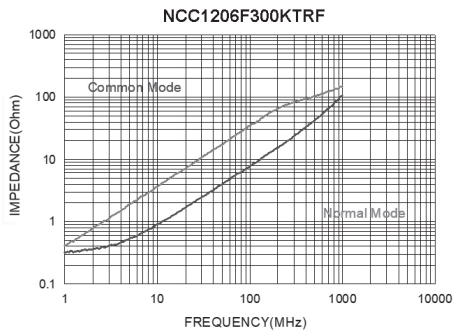

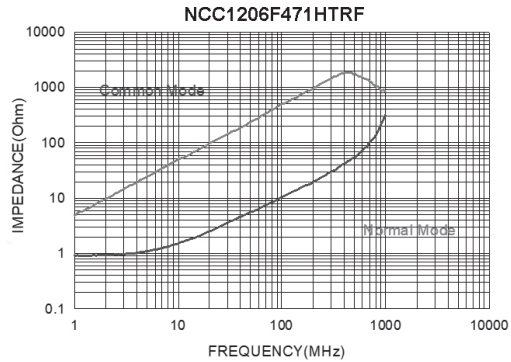
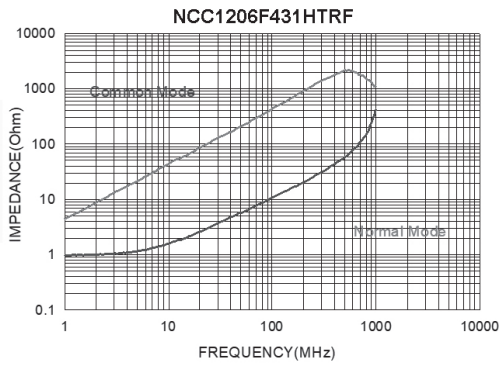
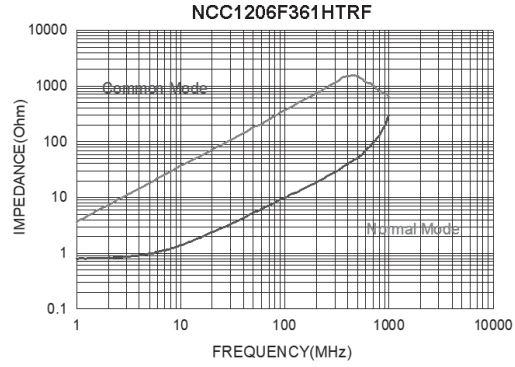
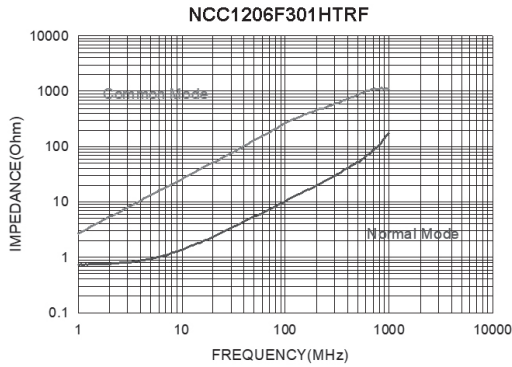
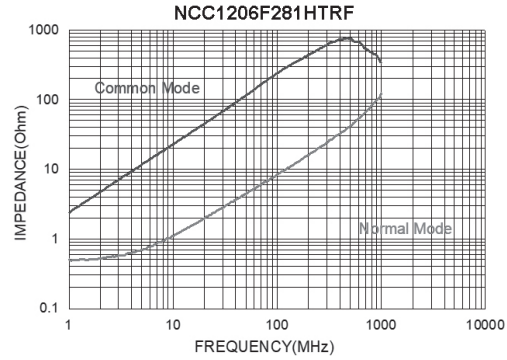
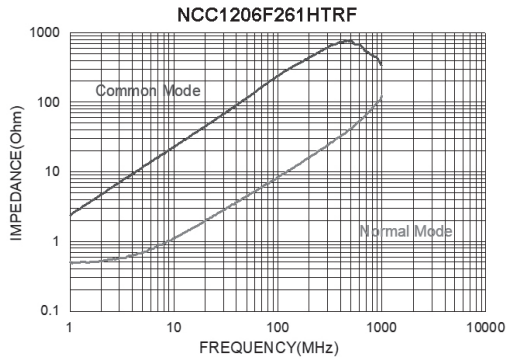
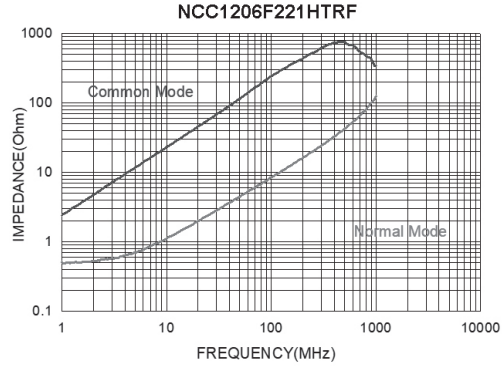
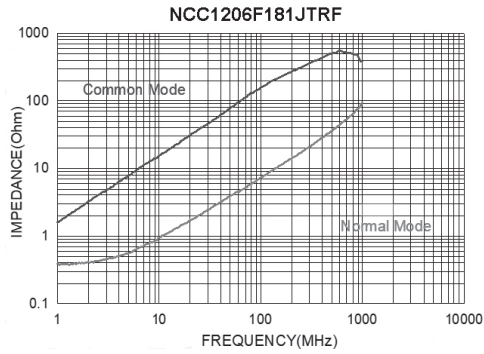

# NCC Series

## Surface Mount Common Mode Chokes

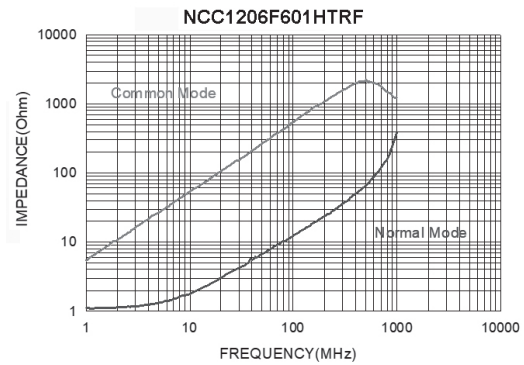
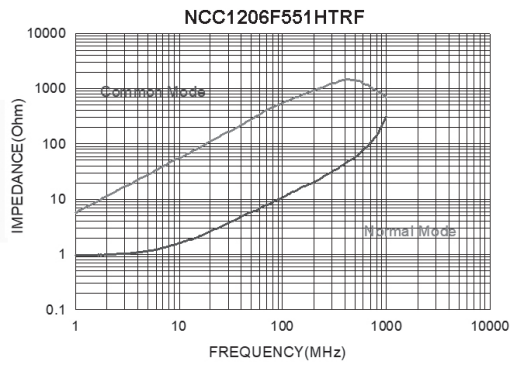

### NCC1210 SPECIFICATIONS

NIC Part Number	Impedance ( $\Omega$ )	Test Frequency (MHz)	DC Resistance ( $\Omega$ max.)	DC Current (mA max.)	Voltage Rating (Vdc)	Withstanding Voltage (Vdc)	Insulation Resistance ( $\Omega$ )
NCC1210F900STRF	90 $\pm$ 25%	100	0.05	1000	50	125	10Meg
NCC1210F601STRF	600 $\pm$ 25%		0.20	1000			
NCC1210F102KTRF	1000 $\pm$ 25%		0.30	400			

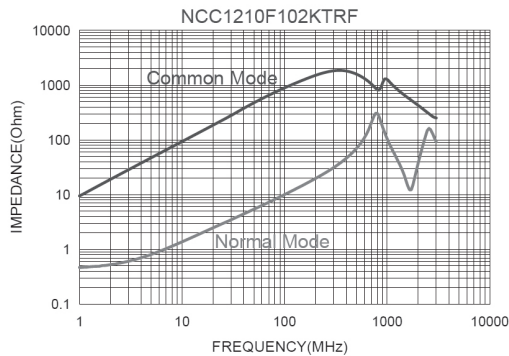
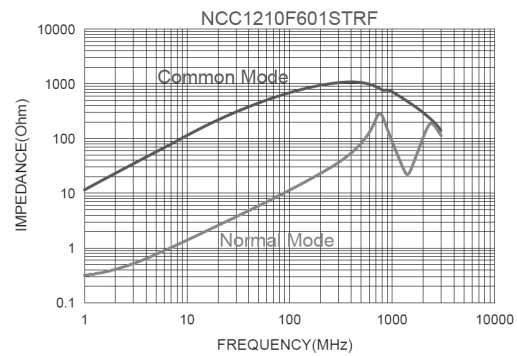
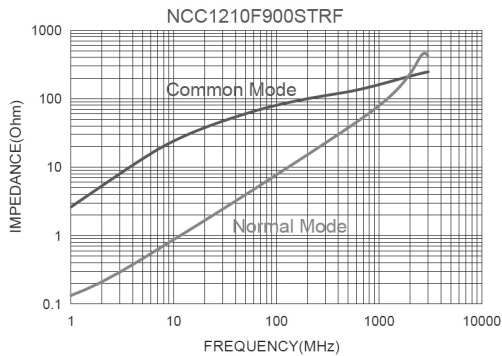

**Performance Passives By Design**

NIC Components Corp.  
100 Baylis Road. Melville, NY 11747

Page 5

[www.niccomp.com](http://www.niccomp.com)

Last Updated 03-20-2023. Specification subject to change without notice. Please check web site for latest information.



**NCC1812 SPECIFICATIONS**

NIC Part Number	Impedance ( $\Omega$ )	Test Frequency (MHz)	DC Resistance ( $\Omega$ max.)	DC Current (mA max.)	Voltage Rating (Vdc)	Withstanding Voltage (Vdc)	Insulation Resistance ( $\Omega$ )
NCC1812F900ZTRF	90 $\pm$ 25%	100	0.05	4000	50	125	10Meg
NCC1812F231YTRF	230 $\pm$ 25%		0.05	3500			
NCC1812F421XTRF	420 $\pm$ 25%		0.055	3200			
NCC1812F601VTRF	600 $\pm$ 25%		0.06	2500			
NCC1812F901UTRF	900 $\pm$ 25%		0.07	2300			
NCC1812F142TTRF	1400 $\pm$ 25%		0.10	2000			
NCC1812F282RTRF	2800 $\pm$ 25%		0.35	900			

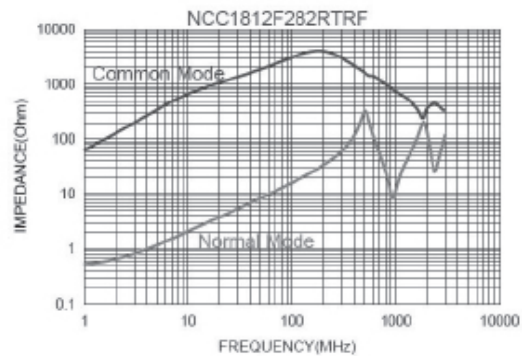
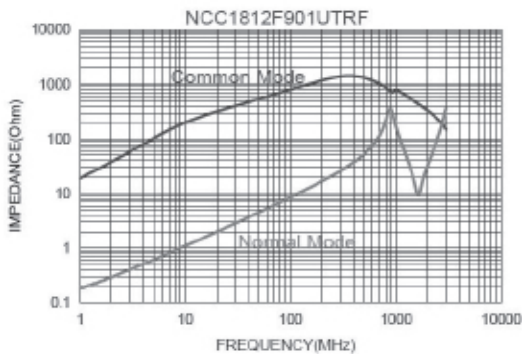
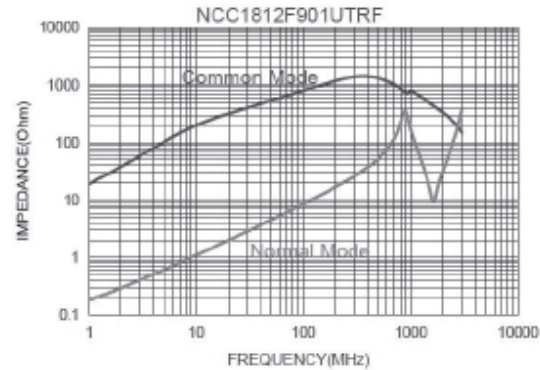
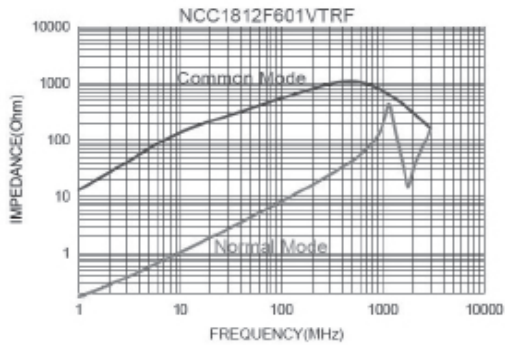
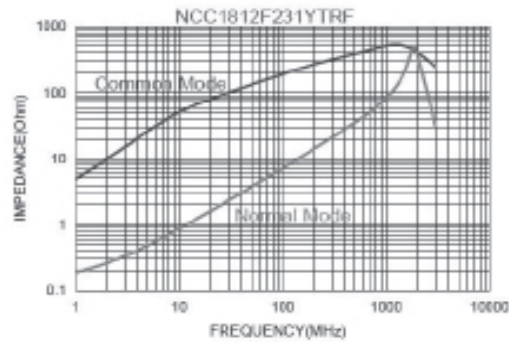
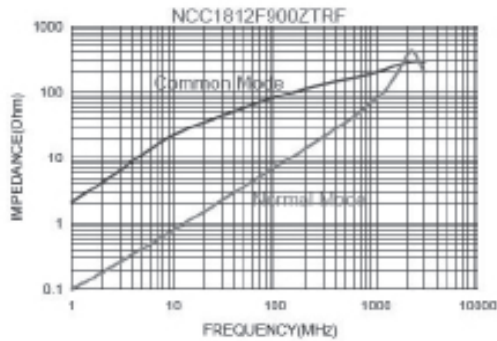



**CASE DIMENSIONS (mm)**

Type	A ±0.2	B ±0.2	C ±0.2	D1 ±0.1	D2 ±0.1	E ±0.1
NCC0805	2.0	1.2	1.2	0.50	0.51	0.15
NCC1206	3.2	1.6	2.0	0.50	0.50	0.15
NCC1210	3.2	2.5	2.2	0.80	0.90	0.15
NCC1812	4.5	3.2	2.8	0.90±0.15	1.05±0.15	0.15±0.10

**CIRCUIT SCHEMATIC**

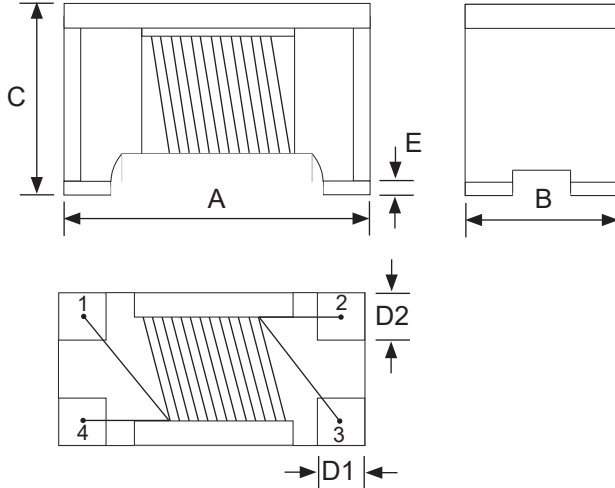
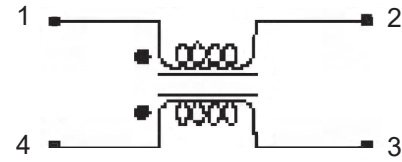

**LAND PATTERN DIMENSIONS (mm)**

Case Size	L	W	T1	T2
0805	2.60	1.25	1.10	0.45
1206	3.70	1.60	1.90	0.40
1210	4.40	3.50	1.60	0.60
1812	5.00	3.60	3.00	1.20

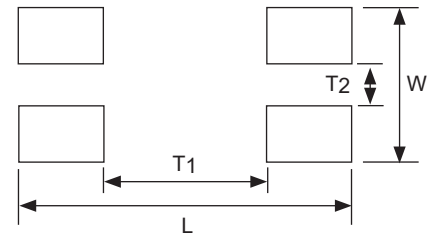

**RECOMMENDED REFLOW SOLDERING PROFILE**

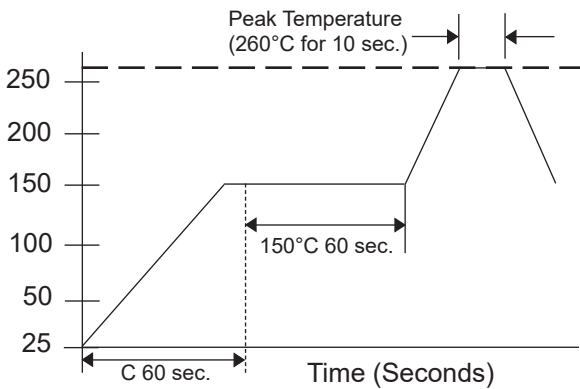

**RECOMMENDED FLOW SOLDERING PROFILE**

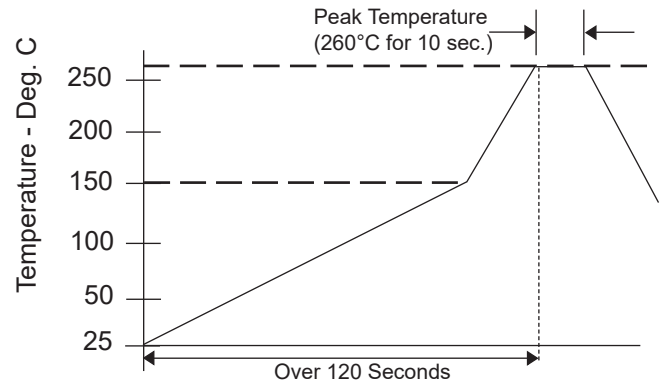

Series	A ± 0.1	B ± 0.1	E ± 0.1	F ± 0.05	P <sub>0</sub> ± 0.1	P <sub>1</sub> ± 0.1	Dφ ± 0.1	W ± 0.1	t <sub>1</sub> ± 0.05	t <sub>2</sub> ± 0.1	Reel Quantity
NCC0805	1.50	2.35	1.75	3.5	4.0	4.0	1.5	8.0	0.22	1.45	2,000
NCC1206	1.88	3.50								2.10	
NCC1210	2.88	3.7								2.5	
NCC1812	3.6	4.9	5.5	8.0	8.0	12.0	0.26	3.0	500		

