

Selection diagram

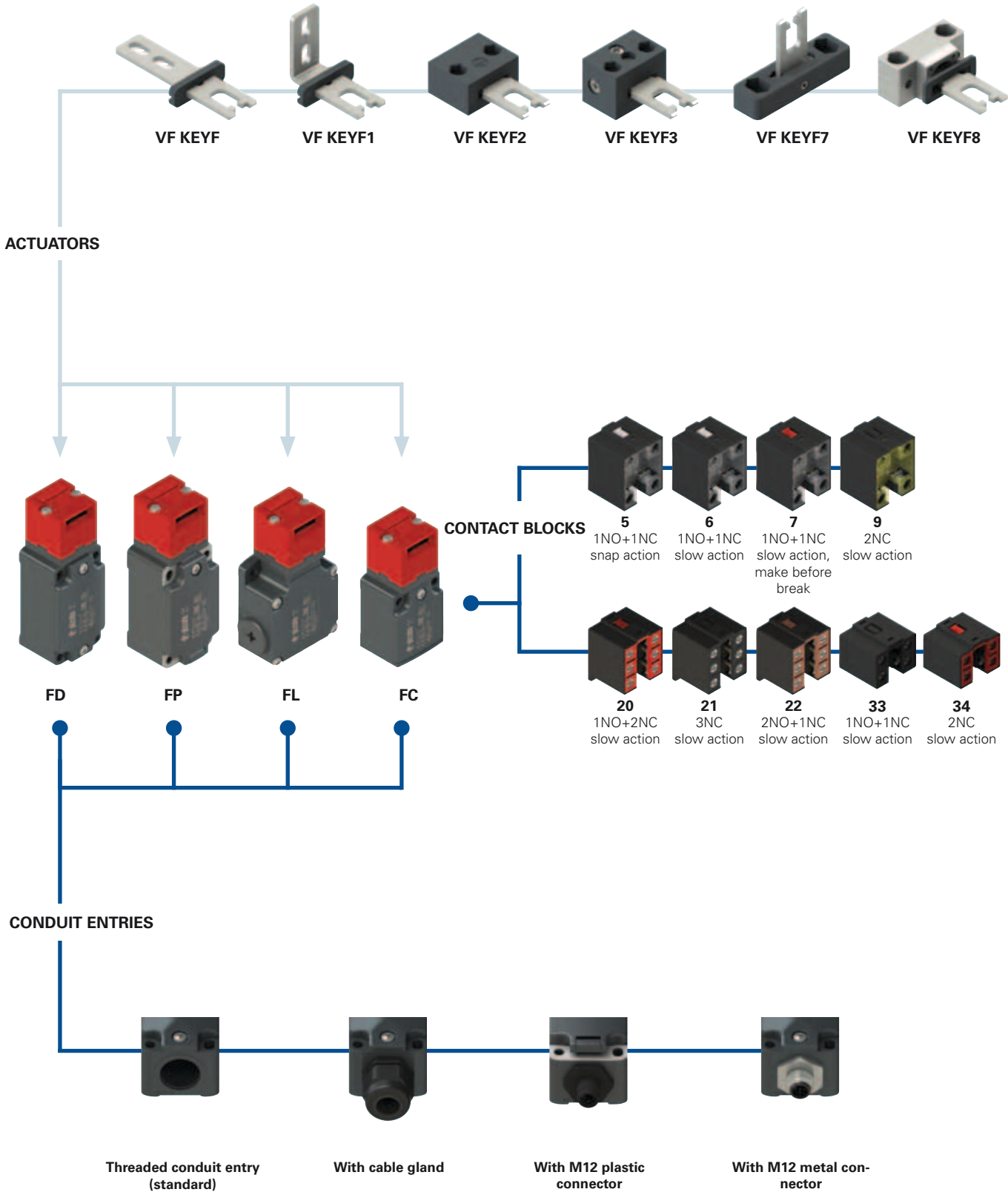

—●— product option
 —▶— accessory sold separately



Code structure **Attention!** The feasibility of a code number does not mean the effective availability of a product. Please contact our sales office.

article options options
FD 693-F1GM2K50T6

Housing	
FD	metal, one conduit entry
FL	metal, three conduit entries
FP	technopolymer, one conduit entry

Contact block	
5	1NO+1NC, snap action
6	1NO+1NC, slow action
7	1NO+1NC, slow action, make before break
9	2NC, slow action
20	1NO+2NC, slow action
21	3NC, slow action
22	2NO+1NC, slow action
33	1NO+1NC, slow action
34	2NC, slow action

Actuators	
	without actuator (standard)
F	straight actuator VF KEYF
F1	angled actuator VF KEYF1
F2	jointed actuator VF KEYF2
F3	jointed actuator adjustable in two directions VF KEYF3
F7	jointed actuator adjustable in one direction VF KEYF7
F8	universal actuator VF KEYF8

Ambient temperature	
	-25°C ... +80°C (standard)
T6	-40°C ... +80°C

Pre-installed cable glands or connectors	
	no cable gland or connector (standard)
K23	cable gland for cables Ø 6 ... 12 mm
...
K50	M12 metal connector, 5-pole
...

For the complete list of possible combinations please contact our technical department.

Threaded conduit entry	
M2	M20x1.5 (standard)
	PG13.5

Contact type	
	silver contacts (standard)
G	silver contacts with 1 µm gold coating
G1	silver contacts, 2.5 µm gold coating (not for contact blocks 20, 21, 22, 33, 34)

article options options
FC 3393-F1GM2K50T6

Housing	
FC	metal, one conduit entry

Contact block	
33	1NO+1NC, slow action
34	2NC, slow action

Actuators	
	without actuator (standard)
F	straight actuator VF KEYF
F1	angled actuator VF KEYF1
F2	jointed actuator VF KEYF2
F3	jointed actuator adjustable in two directions VF KEYF3
F7	jointed actuator adjustable in one direction VF KEYF7
F8	universal actuator VF KEYF8

Ambient temperature	
	-25°C ... +80°C (standard)
T6	-40°C ... +80°C

Pre-installed cable glands or connectors	
	no cable gland (standard)
K23	cable gland for cables Ø 6 ... 12 mm
K50	M12 metal connector, 5-pole

Threaded conduit entry	
M2	M20x1.5 (standard)
	PG11

Contact type	
	silver contacts (standard)
G	silver contacts with 1 µm gold coating

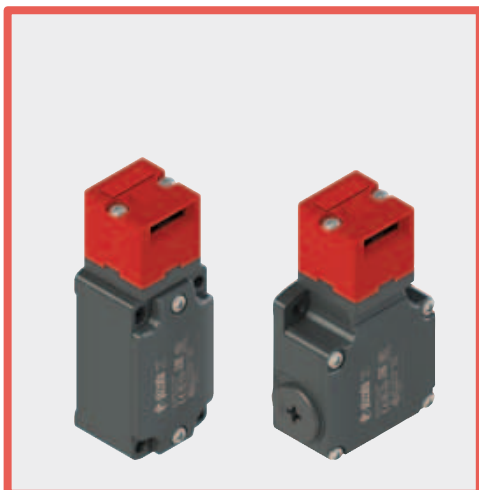

Main features

- Metal housing or technopolymer housing, from one to three conduit entries
- Protection degree IP67
- 9 contact blocks available
- 6 stainless steel actuators available
- Versions with M12 connector
- Versions with gold-plated silver contacts

Quality marks:



IMQ approval:	EG605
UL approval:	E131787
CCC approval:	2007010305230000 (FD-FL-FC series) 2007010305230014 (FP series)
EAC approval:	RU C-IT.A.35.B.00454

Technical data

Housing

FP series housing made of glass fibre reinforced technopolymer, self-extinguishing, shock-proof and with double insulation: 

FD, FL and FC series: metal housing, baked powder coating.

Metal head, baked powder coating.

FD, FP, FC series: one threaded conduit entry: M20x1.5 (standard)

FL series: three threaded conduit entries: M20x1.5 (standard)

Protection degree: IP67 acc. to EN 60529 with cable gland of equal or higher protection degree

General data

For safety applications up to:	SIL 3 acc. to EN 62061 PL e acc. to EN ISO 13849-1
Mechanical interlock, coded:	type 2 acc. to EN ISO 14119
Coding level:	low acc. to EN ISO 14119
Safety parameter B_{10D} :	2,000,000 for NC contacts
Service life:	20 years
Ambient temperature:	-25°C ... +80°C
Max. actuation frequency:	3600 operating cycles/hour
Mechanical endurance:	1 million operating cycles
Max. actuation speed:	0.5 m/s
Min. actuation speed:	1 mm/s
Tightening torques for installation:	see page 313-324

Cable cross section (flexible copper strands)

Contact blocks 20, 21, 22, 33, 34:	min.	1 x 0.34 mm ²	(1 x AWG 22)
	max.	2 x 1.5 mm ²	(2 x AWG 16)
Contact blocks 5, 6, 7, 9:	min.	1 x 0.5 mm ²	(1 x AWG 20)
	max.	2 x 2.5 mm ²	(2 x AWG 14)

In compliance with standards:

IEC 60947-5-1, EN 60947-5-1, EN 60947-1, IEC 60204-1, EN 60204-1, EN ISO 14119, EN ISO 12100, IEC 60529, EN 60529, BG-GS-ET-15, UL 508, CSA 22.2 No.14.

Approvals:

IEC 60947-5-1, UL 508, CSA 22.2 No.14, GB14048.5-2001.

Compliance with the requirements of:

Machinery Directive 2006/42/EC and EMC Directive 2014/30/EU.

Positive contact opening in conformity with standards:

IEC 60947-5-1, EN 60947-5-1

⚠ If not expressly indicated in this chapter, for correct installation and utilization of all articles see chapter utilization requirements from page 313 to page 324.

	Electrical data	Utilization category
without connector	Thermal current (I_{th}):	10 A
	Rated insulation voltage (U_r):	500 Vac 600 Vdc 400 Vac 500 Vdc (contact blocks 20, 21, 22, 33, 34)
	Rated impulse withstand voltage (U_{imp}):	6 kV 4 kV (contact blocks 20, 21, 22, 33, 34)
	Conditional short circuit current: Protection against short circuits: Pollution degree:	1000 A acc. to EN 60947-5-1 type aM fuse 10 A 500 V 3
with M12 connector, 4 or 5-pole	Thermal current (I_{th}):	4 A
	Rated insulation voltage (U_r):	250 Vac 300 Vdc
	Protection against short circuits: Pollution degree:	type gG fuse 4 A 500 V 3
		Alternating current: AC15 (50±60 Hz) U_e (V) 250 400 500 I_e (A) 6 4 1 Direct current: DC13 U_e (V) 24 125 250 I_e (A) 6 1.1 0.4
with M12 connector, 8-pole	Thermal current (I_{th}):	2 A
	Rated insulation voltage (U_r):	30 Vac 36 Vdc
	Protection against short circuits: Pollution degree:	type gG fuse 2 A 500 V 3
		Alternating current: AC15 (50±60 Hz) U_e (V) 24 I_e (A) 2 Direct current: DC13 U_e (V) 24 I_e (A) 2



Description



These safety switches are ideal for controlling gates, sliding doors and other guards which protect dangerous parts of machines without inertia.

The stainless steel actuator is fastened to the moving part of the guard in such a way that it is separated from the switch each time the guard is opened. A special mechanism ensures that removing the actuator forces the positive opening of the electrical contacts. Easy to install, these switches can be used with all types of guards (with hinge as well as sliding and removable types). The possibility to actuate the switch only with a specific actuator guarantees that the machine can be restarted only after the guard has been closed. These switches are made of robust materials with larger dimensions and are designed especially for heavy gates and harsh environments.

Head with variable orientation

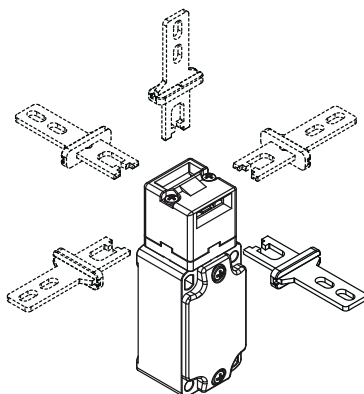

For all switches, the head can be adjusted in 90° steps after removing the two fastening screws. In this way it is possible to actuate the switch from 5 different directions.

Wide-ranging actuator travel

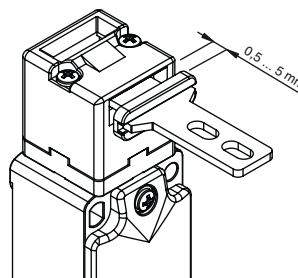

The actuation head of this switch features a wide range of travel. In this way the guard can oscillate along the direction of insertion (4.5 mm) without causing unwanted machine shutdowns. This wide range of travel is available in all actuators in order to ensure maximum device reliability.

Protection degree IP67

IP67

These devices are designed to be used in the toughest environmental conditions and they pass the IP67 immersion test acc. to EN 60529. They can therefore be used in all environments where maximum protection degree of the housing is required.

Safety screws for actuators

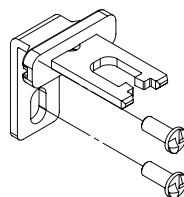

As required by EN ISO 14119, the actuator must be fixed immovably to the door frame. Pan head safety screws with one-way fitting are available for this purpose. With this screw type, the actuators cannot be removed or tampered by using common tools. See accessories on page 310.

Extended temperature range

-40°C

These devices are also available in a special version suitable for an ambient operating temperature range from -40°C up to +80°C.

They can therefore be used for applications in cold stores, sterilisers and other equipment with low temperature environments. The special materials used to produce these versions retain their characteristics even under these conditions, thereby expanding the installation possibilities.

Laser engraving



All devices are marked using a dedicated indelible laser system. These engravings are therefore suitable for extreme environments too. Thanks to this system that does not use labels, the loss of plate data is prevented and a greater resistance of the marking is achieved over time.

Features approved by IMQ

Rated insulation voltage (U _i):	500 Vac 400 Vac (for contact blocks 20, 21, 22, 33, 34)
Conventional free air thermal current (I _{th}):	10 A
Protection against short circuits:	type aM fuse 10 A 500 V
Rated impulse withstand voltage (U _{imp}):	6 kV 4 kV (for contact blocks 20, 21, 22, 33, 34)
Protection degree of the housing:	IP67
MV terminals (screw terminals)	
Pollution degree:	3
Utilization category:	AC15
Operating voltage (U _e):	400 Vac (50 Hz)
Operating current (I _e):	3 A

Forms of the contact element: Zb, Y+Y, Y+Y+X, Y+Y+Y, Y+X+X

Positive opening contacts on contact blocks 5, 6, 7, 9, 20, 21, 22, 33, 34

In compliance with standards: EN 60947-1, EN 60947-5-1+ A1:2009, fundamental requirements of the Low Voltage Directive 2014/35/EU.

Please contact our technical department for the list of approved products.

Features approved by UL

Utilization categories	Q300 (69 VA, 125-250 Vdc) A600 (720 VA, 120-600 Vac)
Housing features type 1, 4X "indoor use only"; 12, 13	
For all contact blocks use 60 or 75 °C copper (Cu) conductor, rigid or flexible, wire size 12, 14 AWG. Tightening torque for terminal screws of 7.1 lb in (0.8 Nm).	

In compliance with standard: UL 508, CSA 22.2 No.14.

Please contact our technical department for the list of approved products.

Dimensional drawings

All values in the drawings are in mm

Contact type:

- R = snap action
L = slow action
LO = slow action, make before break

Contact block

	Technopolymer housing		Metal housing		Metal housing		Metal housing	
	Without actuator		Without actuator		Without actuator		Without actuator	
5	R	FP 593-M2 \oplus 1NO+1NC	FD 593-M2 \oplus 1NO+1NC	FL 593-M2 \oplus 1NO+1NC				
6	L	FP 693-M2 \oplus 1NO+1NC	FD 693-M2 \oplus 1NO+1NC	FL 693-M2 \oplus 1NO+1NC				
7	LO	FP 793-M2 \oplus 1NO+1NC	FD 793-M2 \oplus 1NO+1NC	FL 793-M2 \oplus 1NO+1NC				
9	L	FP 993-M2 \oplus 2NC	FD 993-M2 \oplus 2NC	FL 993-M2 \oplus 2NC				
20	L	FP 2093-M2 \oplus 1NO+2NC	FD 2093-M2 \oplus 1NO+2NC	FL 2093-M2 \oplus 1NO+2NC				
21	L	FP 2193-M2 \oplus 3NC	FD 2193-M2 \oplus 3NC	FL 2193-M2 \oplus 3NC				
22	L	FP 2293-M2 \oplus 2NO+1NC	FD 2293-M2 \oplus 2NO+1NC	FL 2293-M2 \oplus 2NO+1NC				
33	L	FP 3393-M2 \oplus 1NO+1NC	FD 3393-M2 \oplus 1NO+1NC	FL 3393-M2 \oplus 1NO+1NC			FC 3393-M2 \oplus 1NO+1NC	
34	L	FP 3493-M2 \oplus 2NC	FD 3493-M2 \oplus 2NC	FL 3493-M2 \oplus 2NC			FC 3493-M2 \oplus 2NC	
Actuating force		10 N (18 N \oplus)	10 N (18 N \oplus)	10 N (18 N \oplus)			10 N (18 N \oplus)	

How to read travel diagrams

All values in the diagrams are in mm

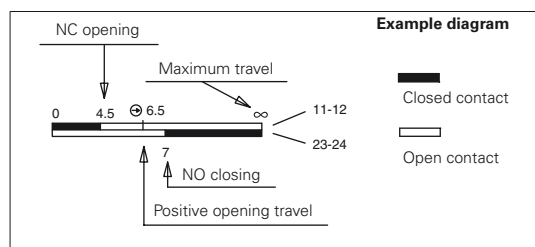
**IMPORTANT:**

The state of the NC contact refers to the switch with inserted actuator. In **safety applications**, actuate the switch **at least up to the positive opening travel** shown in the travel diagrams with symbol \oplus . Actuate the switch **at least with the positive opening force**, reported in brackets below each article, next to the actuating force value.

Limits of use

Do not use where dust and dirt may penetrate in any way into the head and deposit there. Especially not where powder, shavings, concrete or chemicals are sprayed. Adhere to the EN ISO 14119 requirements regarding low level of coding for interlocks. Do not use in environments with presence of explosive or flammable gas. In these case use ATEX products (see dedicated Pizzato catalogue).



Stainless steel actuators

All values in the drawings are in mm

IMPORTANT: These actuators can be used only with items of the FD, FP, FL, FC and FS series (e.g. FD 693-M2).
Low level of coding acc. to EN ISO 14119.

Article	Description
VF KEYF	Straight actuator

Article	Description
VF KEYF1	Angled actuator

Article	Description
VF KEYF2	Jointed actuator

Article	Description
VF KEYF3	Actuator adjustable in two directions

The actuator can flex in four directions for applications where the door alignment is not precise.

Actuator adjustable in two directions for doors with reduced dimensions.

Article	Description
VF KEYF7	Actuator adjustable in one direction

Actuator adjustable in one direction for doors with reduced dimensions.

Article	Description
VF KEYF8	Universal actuator

Actuator adjustable in two dimensions for small doors; can be mounted in various positions.

The fixing block has two pairs of bore holes; it is provided for rotating the working plane of the actuator by 90°.

Body material: zinc alloy.

Accessories

Article	Description
VF KB1	Actuator entry locking device

Padlockable device to lock the actuator entry in order to prevent the accidental closing of the door behind operators while they are in the danger area.

Items with code on **green** background are stock items

Accessories See page 299

→ The 2D and 3D files are available at www.pizzato.com