

Approximate Performance in Laboratory Tests

Direct Torque: 50 Nm
Tensile Strength: 32000 N
Shear Strength: 5000 N

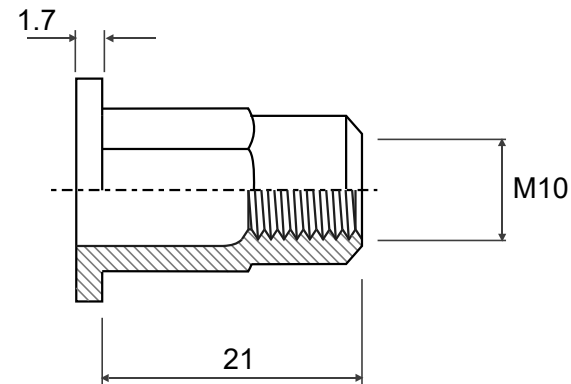
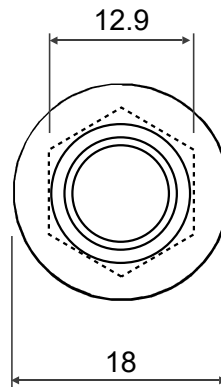
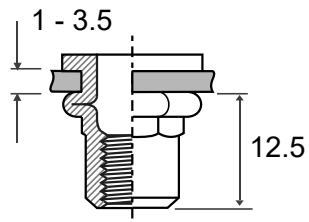

	Material		Customer Part No.	
	Finish		Web Ref No	