

C&K S Series Slide Switches

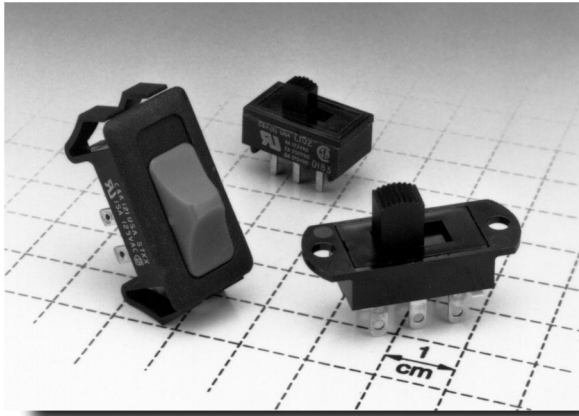

Features/Benefits

- 6 to 15 AMPS
- Enclosed housing
- PC and Snap-in panel mounting
- Reversing option



Typical Applications

- Portable tools
- Small appliances
- Floor care products

Build-A-Switch

Our easy Build-A-Switch concept allows you to mix and match options to create the switch you need. Below is a complete listing of options shown in catalog. To order, simply select desired option from each category and place in the appropriate box. Switches with standard options are shown on page E-31. Available options are shown and described on pages E-32 thru E-35. For additional options not shown in catalog, consult Customer Service Center.

Typical Example: S 1 0 1 — 0 3 — 1 — S S — 0 3 — — Q —

Switch Function

- S101** (STD.) SPST, 6 AMPS
- S202** (STD.) DPDT, 6 AMPS
- S802** (STD.) DPDT, 15 AMPS
- S102** SPDT, 6 AMPS
- S111** SPST, mom., 6 AMPS
- S112** SPDT, mom., 6 AMPS
- S201** DPST, 6 AMPS
- S501** SPST, 12 AMPS
- S502** SPDT, 12 AMPS
- S511** SPST, mom., 12 AMPS
- S512** SPDT, mom., 12 AMPS
- S601** DPST, 12 AMPS
- S602** DPDT, 12 AMPS
- S701** SPST, 15 AMPS
- S702** SPDT, 15 AMPS
- S711** SPST, mom., 15 AMPS
- S712** SPDT, mom., 15 AMPS
- S801** DPST, 15 AMPS

Actuator

- 03** (STD.) .335" high
- 04** .500" high
- 09** .250" high
- 12** Screwdriver slot (with marking)
- 13** Screwdriver slot (without marking)
- C1** White snap-on cap
- C2** Black cap
- C3** Red cap
- CT** Beige cap

Detent

- 1** (STD.) With detent
- 2** (STD.) Without detent

Mounting Style

- SS** (STD.) Panel with mounting ears
- MS** PC thru-hole
- S1** Snap-in panel
- S2** Snap-in panel
- S3** Snap-in panel
- ST** Snap-in panel

Terminations

- 03** (STD.) Solder lug with hole
- 01** Solder lug with notch
- 02** PC Thru-hole
- 04** PC Thru-hole
- 07** Quick connect
- 08** PC Thru-hole
- 51** Reversing feature
- 52** Reversing feature
- 53** Reversing feature
- 54** Reversing feature
- 57** Reversing feature
- WC** Wire lead
- WR** Reversing feature

Housing Markings

- NONE** (STD.) No markings
- D** ON-OFF
- L** ON
- M** ON-OFF
- N** Red rectangle on one end

Contact Material

- Q** (STD.) Silver
- B** Gold
- G** Gold over silver

Seal

- NONE** (STD.) No seal
- E** Epoxy seal

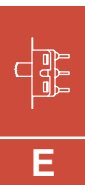

Slide

Specifications

CONTACT RATING: Q contact material (S1XX, S2XX Models): 6 AMPS @ 125 V AC; 6 AMPS @ 250 V AC; 1 AMP @ 125 V DC (UL/CSA). (S5XX, S6XX Models): 12 AMPS @ 125 V AC; 6 AMPS @ 250 V AC; 1 AMP @ 125 V DC (UL/CSA). (S7XX, S8XX Models): 15 AMPS @ 125 V AC; 6 AMPS @ 250 V AC (UL/CSA). See page E-35 for additional ratings.

ELECTRICAL LIFE: 10,000 make-and-break cycles at full load.

CONTACT RESISTANCE: Below 10 milliohms typ. initial @ 2-4 V DC, 100 mA, for both silver and gold plated contacts.

INSULATION RESISTANCE: 10⁹ ohms min.

DIELECTRIC STRENGTH: 1,000 V RMS min. @ sea level.

Materials

HOUSING: 6/6 nylon (UL94V-2), black.

TOP PLATE: 6/6 nylon (UL94V-2), black.

ACTUATOR: 6/6 nylon (UL94V-2), black (standard).

CONTACTS: Q contact material: Copper, silver plated. See page E-35 for additional contact materials.

TERMINALS: Q contact material: Copper, silver plated. See page E-35 for additional contact materials.

CONTACT SPRING: Music wire or stainless steel.

TERMINAL SEAL: Epoxy.

NOTE: Specifications and materials listed above are for switches with standard options. For information on specific and custom switches, consult Customer Service Center.

SWITCHES WITH STANDARD OPTIONS

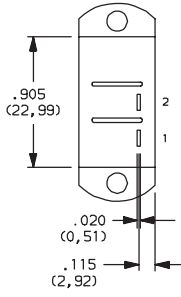
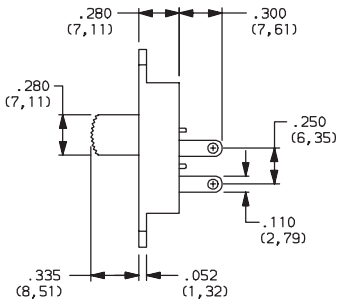
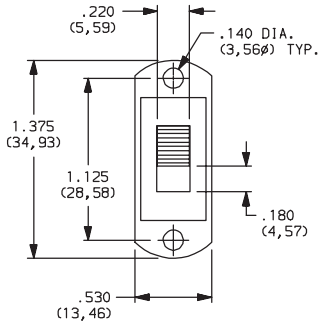

S101031SS03Q
SPST

TERM. NOS. FOR REFERENCE ONLY

PART NUMBER	FUNCTION	AMP RATING
S101031SS03Q	SPST	6

NOTE: For panel mounting information, see page E-33.

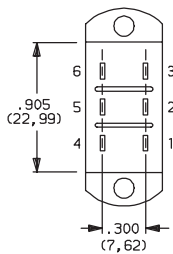
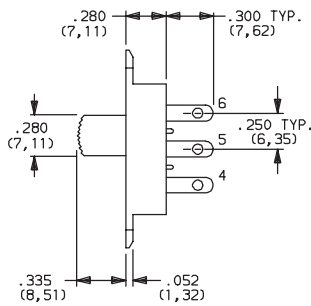
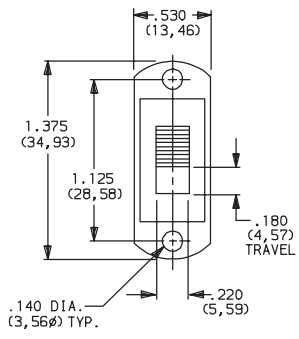

S202031SS03Q
DPDT

TERM. NOS. FOR REFERENCE ONLY













PART NUMBER	FUNCTION	AMP RATING
S202031SS03Q	DPDT	6







NOTE: For panel mounting information, see page E-33.





C&K S Series Slide Switches

SWITCH FUNCTION

NO. POLES	MODEL NO.	AMP RATING	SWITCH FUNCTION	SCHEMATIC	AVAILABLE MOUNTING STYLES
SP	S101 (STD.)	6	SPST		MM,SS
	S102	6	SPDT		MS
	S111	6	SPST-MOM.		MS
	S112	6	SPDT-MOM.		MS,SS
	S501	12	SPST		MS,SS
	S502	12	SPDT		MS,SS
	S511	12	SPST-MOM.		MS,SS
	S512	12	SPDT-MOM.		MS,SS
	S701	15	SPST		S1,S2,S3,ST
	S702	15	SPDT		S1,S2,S3,ST
	S711	15	SPST-MOM.		S1,S2,S3,ST
	S712	15	SPDT-MOM.		S1,S2,S3,ST

NO. POLES	MODEL NO.	AMP RATING	SWITCH FUNCTION	SCHEMATIC	AVAILABLE MOUNTING STYLES
DP	S201	6	DPST		MS,SS
	S202 (STD.)	6	DPDT		MS,SS
	S601	12	DPST		MS,SS
	S602	12	DPDT		MS,SS
	S801	15	DPST		S1,S2,S3,ST
	S802 (STD.)	15	DPDT		S1,S2,S3,ST

NOTE:  and MOM. in table indicates momentary action.

All models   with all options when ordered with 'G' or 'Q' contact material.

Contacts make on side actuator thrown.

ACTUATOR

03 (STD.) .335" HIGH

04 .500" HIGH

09 .250" HIGH

12 SCREWDRIVER SLOT
(WITH MARKING)

13 SCREWDRIVER SLOT
(WITHOUT MARKING)

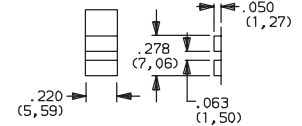
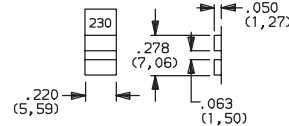
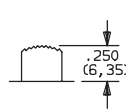
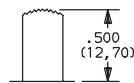
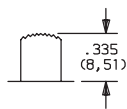

NOTE: Standard actuator color is black, other colors available, consult Customer Service Center. Alternate heights are available with '03, 04, 09 and 10' actuators, consult Customer Service Center. Models with 'S1, S2, S3 and ST' mounting style, subtract .090 (2,29). Actuators '12' and '13' are available with DPST and DPDT models only.

White 115-230 markings (std.).

Without markings.

C1-CT SNAP-ON CAP

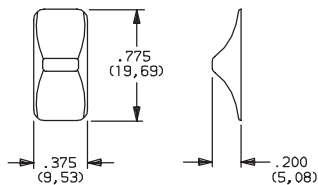

Available with 'S1, S2, S3 and ST' mounting style only.

OPTION CODE2	C1-CT CAP COLOR
C2	(STD.) BLACK
C1	WHITE
C3	RED
CT	BEIGE

NOTE: Actuator finish: matte. If no color is specified, black will be supplied. Colored actuator caps may also be ordered separately and user installed, see page L-9.

DETENT

1 (STD.) WITH DETENT

Standard with all maintained models: S101, S102, S103, S202, S203, S501, S502, S601, S602, S701, S702, S801 and S802.

2 (STD.) WITHOUT DETENT

Standard with all momentary models: S111, S112, S511, S512, S711 and S712.

MOUNTING STYLE

SS (STD.) PANEL WITH MOUNTING EARS

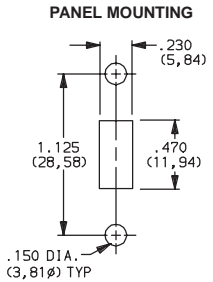
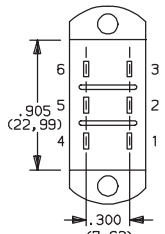
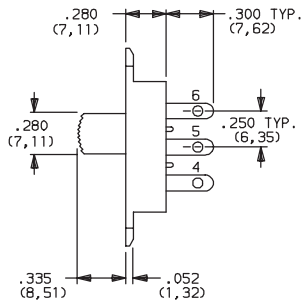
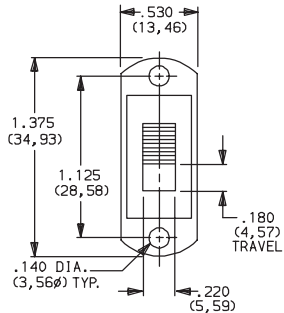

S202031SS03Q
DPDT

AVAILABLE WITH:

Models: S101, S102, S111, S112, S201, S202, S501, S502, S511, S512, S601 and S602
Terminations: All except 08
Actuators: 03, 04, 09, 10, 12* and 13*
 *12 and 13 actuators not available with S1XX models.

MS PC THRU-HOLE

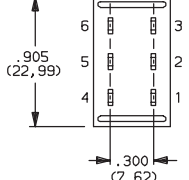
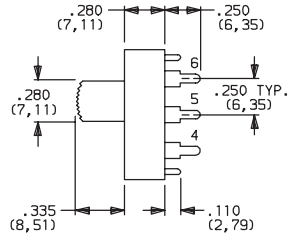
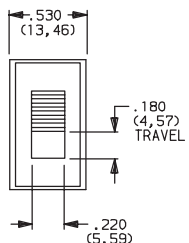

AVAILABLE WITH:

Models: S101, S111, S102, S112, S201, S202.
Terminations: 02, 04, 08, 52 and 54
Actuators: 03, 04, 09, 10, 12* and 13*
 *12 and 13 actuators available with S201, S202, S601 and S602 models only.

PC MOUNTING

For mounting information, see TERMINATIONS section, page E-34.



S202031MS02Q
DPDT

S1-ST SNAP-IN PANEL

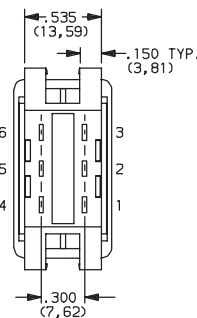
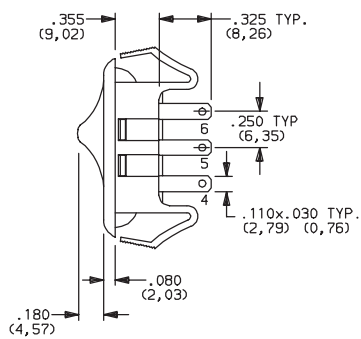
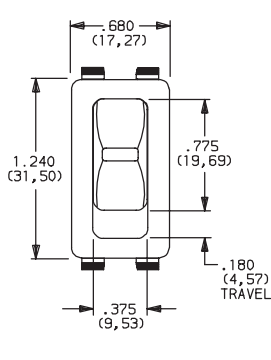

PANEL MOUNTING

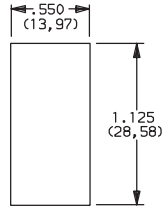

PANEL THICKNESS:
 .020(0,57)–.200(5,08)



S802C21S207Q
DPDT

AVAILABLE WITH:

Models: S701, S702, S711, S712, S801 and S802
Terminations: 04, 07, 54, 57, WC and WR
Actuators: C1, C2, C3, CT and 03

OPTION CODE	TOP PLATE COLOR
S2	(STD.) BLACK
S1	WHITE
S3	RED
ST	BEIGE

NOTE: Housing top plate finish: matte. If no color is specified, black will be supplied.



C&K S Series Slide Switches

TERMINATIONS

03 (STD.) SOLDER LUG WITH HOLE

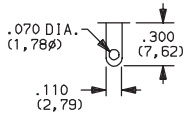

01 SOLDER LUG WITH NOTCH

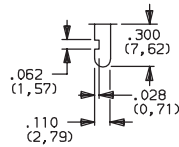

02 PC THRU-HOLE

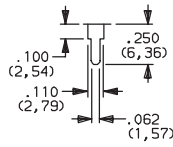

Recommended with 'MS' mounting style only.

04 PC THRU-HOLE

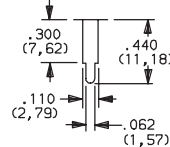

Recommended with double pole mounting style only.

07 QUICK CONNECT

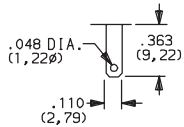

08 PC THRU-HOLE

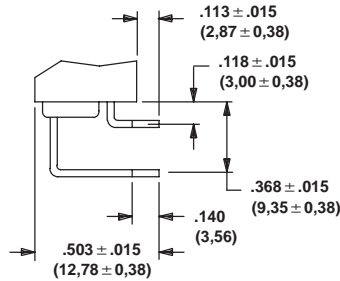

MS mounting style only.

WC WIRE LEAD

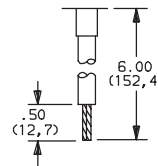

18 AWG wire for S1XX and S2XX models.
16 AWG wire for all other models. Black wire standard, other colors and lengths available, consult Customer Service Center. UL style 1015.

PC MOUNTING

02 & 04 terminations

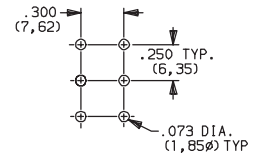

08 terminations with MS mounting style.

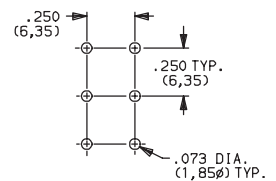

NOTE: All terminals on S1XX, S2XX, S5XX and S6XX models are .020 (0,51) thick; all terminals on S7XX and S8XX models are .031 (0,79) thick.

REVERSING SWITCH OPTION

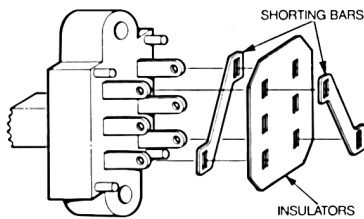

DPST and DPDT models are only available with two diagonal terminal jumper strips, providing reversing capability. Select desired termination option from chart.

REVERSING SWITCH TERMINATION OPTIONS

OPTION CODE	DESCRIPTION
51	01 TERMINALS + REVERSING FEATURE
52	02 TERMINALS + REVERSING FEATURE
53	03 TERMINALS + REVERSING FEATURE
54	04 TERMINALS + REVERSING FEATURE
57	07 TERMINALS + REVERSING FEATURE
WR	WC TERMINALS + REVERSING FEATURE

TOP PLATE MARKINGS

NONE (STD.) NO MARKINGS

D ON-OFF

L ON

M ON-OFF

N RED RECTANGLE ON ONE END

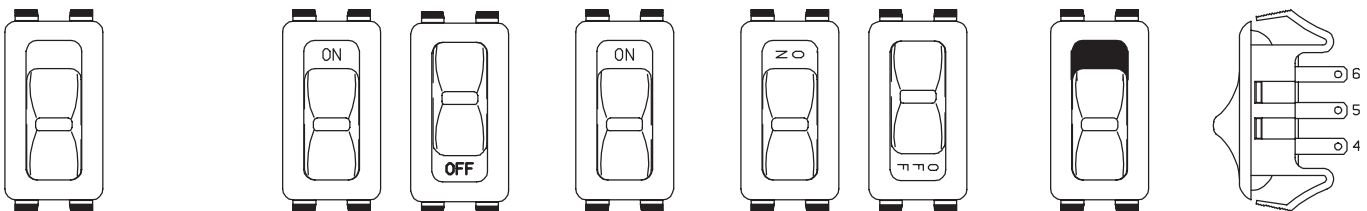

NOTE: Top plate markings are available with 'S1, S2, S3 and ST' mounting style only. The marking color on all top plates with marking options 'D, L and M' is white, standard. (except white top plates: marking color is black, standard). The marking color on all top plates with 'N' marking option is red, standard. Other marking colors are available, consult Customer Service Center.

Note: Orientation of actuator markings and terminals.

CONTACT MATERIAL

OPTION CODE	CONTACT AND TERMINAL MATERIAL	RATINGS	
Q (STD.)	SILVER ²	POWER	S1XX, S2XX MODELS: 6 AMPS @ 125 V AC; 6 AMPS @ 250 V AC; 1 AMP @ 125 V DC (UL/CSA). S5XX, S6XX MODELS: 12 AMPS @ 125 V AC; 6 AMPS @ 250 V AC; 1 AMP @ 125 V DC (UL/CSA). S7XX, S8XX MODELS: 15 AMPS @ 125 V AC; 6 AMPS @ 250 V AC (UL/CSA).
B	GOLD ¹	LOW LEVEL/DRY CIRCUIT	0.4 VA MAX. @20 V AC OR DC max.
G	GOLD OVER SILVER ³	LOW LEVEL/DRY CIRCUIT OR POWER	S1XX, S2XX MODELS: 0.4 VA MAX. @ 20 V AC OR DC MAX. OR 6 AMPS @ 125 V AC; 6 AMPS @ 250 V AC; 1 AMP @ 125 V DC (UL/CSA). S5XX, S6XX MODELS: 0.4 VA MAX. @ 20 V AC OR DC MAX. OR 12 AMPS @ 125 V AC; 6 AMPS @ 250 V AC; 1 AMP @ 125 V DC (UL/CSA). S7XX, S8XX MODELS: 0.4 VA MAX. @ 20 V AC OR DC MAX. OR 15 AMPS @ 125 V AC; 6 AMPS @ 250 V AC (UL/CSA).

CONTACT MATERIAL/APPLICATION RECOMMENDATIONS — SEE CHART, PAGE L-31.

¹ CONTACTS & TERMINALS: Copper, with gold plate over nickel plate.
² CONTACTS & TERMINALS: Copper, silver plated (standard with all termination options).
³ CONTACTS & TERMINALS: Copper, with gold plate over nickel plate over silver plate.

All models  with all options when ordered with 'G' or 'Q' contact material.
NOTE: 'G' contact material is equivalent to both 'B' and 'Q' contact materials.

SEAL

NONE (STD.) NO SEAL

E EPOXY SEAL

