

## ADJUSTABLE HIGH PRECISION SHUNT REGULATOR

### ■GENERAL DESCRIPTION

**NJM2373 / NJM2373A / NJM2376** is an adjustable high precision shunt regulator.

The output voltage can be adjusted to any value between reference voltage and 14V by two extend resistors.

### ■PACKAGE OUTLINE



**NJM2373F/AF**  
**NJM2376F**

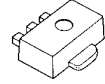

**NJM2373AU**  
**NJM2376U**

### ■FEATURES

- Operating Voltage  $V_{REF}$  to 13V
- High Precision Voltage Reference
 

NJM2373	1.25V±2%
NJM2373A/76	1.25V±1%
- Minimum Input Current 80µA typ.
- Adjustable Output Voltage
- Bipolar Technology
- Package Outline SOT-89 (3pin), MTP5

### ■BLOCK DIAGRAM

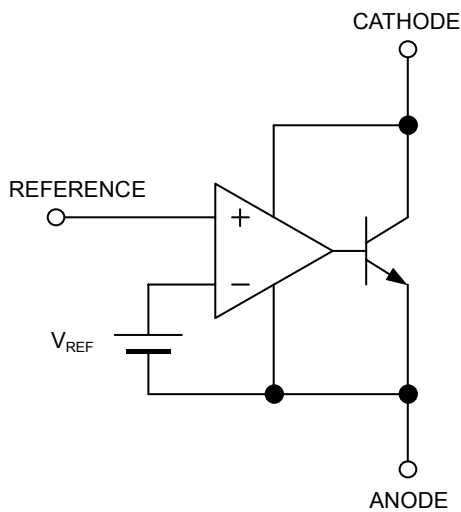

### ■PIN CONFIGURATION

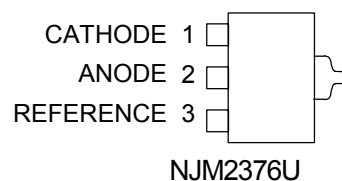
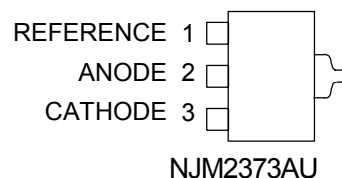
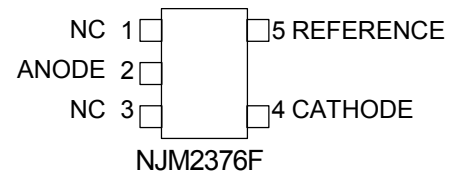
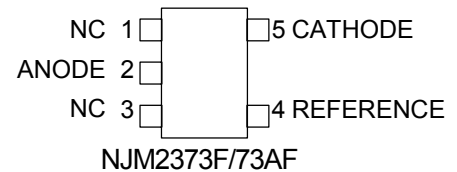

# NJM2373/73A/76

## ■ABSOLUTE MAXIMUM RATINGS (Ta=25°C)

PARAMETER	SYMBOL	MAXIMUM RATINGS	UNIT
Cathode Voltage	$V_{KA}$	+14	V
Continuous Cathode Current	$I_K$	-30 ~ 50	mA
Reference Input Current	$I_{REF}$	-10 ~ 0.05	mA
Power Dissipation	$P_D$	(SOT-89) 350 (MTP5) 200	mW
Operating Temperature Range	$T_{OPR}$	-40 ~ +85	°C
Storage Temperature Range	$T_{STG}$	-40 ~ +150	°C

## ■RECOMMENDED OPERATING CONDITIONS (Ta=25°C)

PARAMETER	SYMBOL	MIN.	TYP.	MAX.	UNIT
Cathode Voltage	$V_{KA}$	$V_{REF}$	—	13	V
Cathode Current	$I_K$	0.5	—	30	mA

## ■ELECTRICAL CHARACTERISTICS ( $I_K=1mA$ , Ta=25°C)

PARAMETER	SYMBOL	TEST CONDITION	MIN.	TYP.	MAX.	UNIT
Reference Voltage	$V_{REF}$	$V_{KA}=V_{REF}$ NJM2373A (*1)	1225	1250	1275	mV
		$V_{KA}=V_{REF}$ NJM2373A/ NJM2376 (*1)	1237	1250	1263	
Reference Voltage Change vs. Cathode Voltage Change	$\Delta V_{REF}/\Delta V_{KA}$	$ V_{REF}  \leq V_{KA} \leq 5V$ (*2)	—	—	$\pm 2.7$	mV/V
		$5V \leq V_{KA} \leq 13V$ (*2)	—	—	$\pm 2.0$	mV/V
Reference Input Current	$I_{REF}$	$V_{KA}=V_{REF}$ $R1=10k\Omega$ , $R2=\infty$ (*2)	—	2.0	4.0	$\mu A$
Minimum Input Current	$I_{MIN}$	$V_{KA}=V_{REF}$ , $\Delta V_{REF}=\pm 1\%$ (*1)	—	80	500	$\mu A$
Cathode Current (Off Cond.)	$I_{OFF}$	$V_{KA}=13V$ , $V_{REF}=0V$ (*3)	—	0.01	1.0	$\mu A$
Dynamic Impedance	$ Z_{KA} $	$V_{KA}=V_{REF}$ , $f \leq 1kHz$ $0.5mA \leq I_K \leq 30mA$ (*1)	—	0.12	—	$\Omega$

## ■TEMPERATURE CHARACTERISTICS ( $I_K=1mA$ , Ta= -40°C ~ 85°C)

PARAMETER	SYMBOL	TEST CONDITION	MIN.	TYP.	MAX.	UNIT
Reference Voltage Change	$\Delta V_{REF}$	$V_{KA}=V_{REF}$ (*1)	—	$\pm 10$	—	mV
Reference Input Current Change	$\Delta I_{REF}$	$V_{KA}=V_{REF}$ $R1=10k\Omega$ , $R2=\infty$ (*2)	—	0.5	—	$\mu A$

$|V_{REF}|$  ...Reference voltage includes error.

(\*1): Test Circuit (Fig.1)

(\*2): Test Circuit (Fig.2)

(\*3): Test Circuit (Fig.3)

## ■TEST CIRCUIT

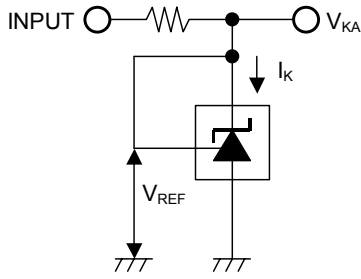

Fig.1  $V_{KA}=V_{REF}$  to test circuit

$$V_O = V_{KA} = V_{REF}$$

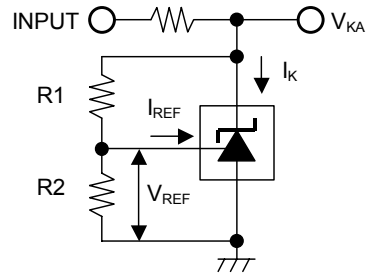

Fig.2  $V_{KA} > V_{REF}$  to test circuit

$$V_O = V_{KA} = V_{REF} \left( 1 + \frac{R1}{R2} \right) + I_{REF} \times R1$$

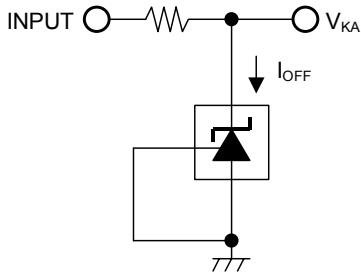

Fig.3  $I_{OFF}$  to test circuit

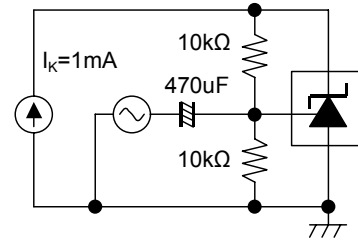
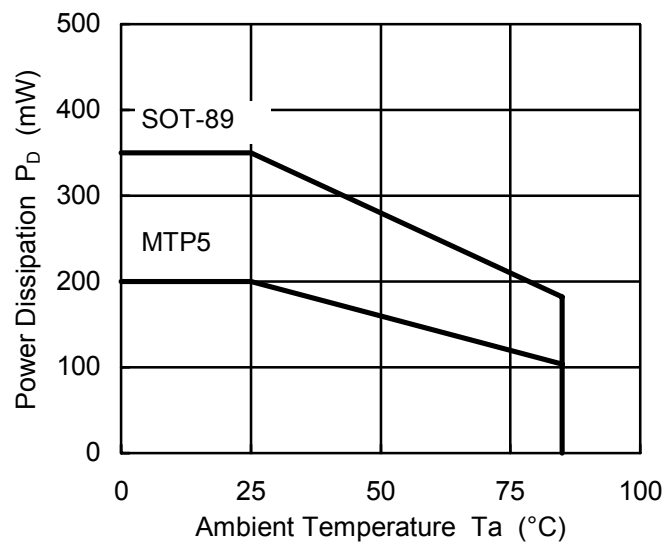

Fig.4 Gain and Phase to test circuit

## ■POWER DISSIPATION VS. AMBIENT TEMPERATURE



# NJM2373/73A/76

## ■ TYPICAL CHARACTERISTICS

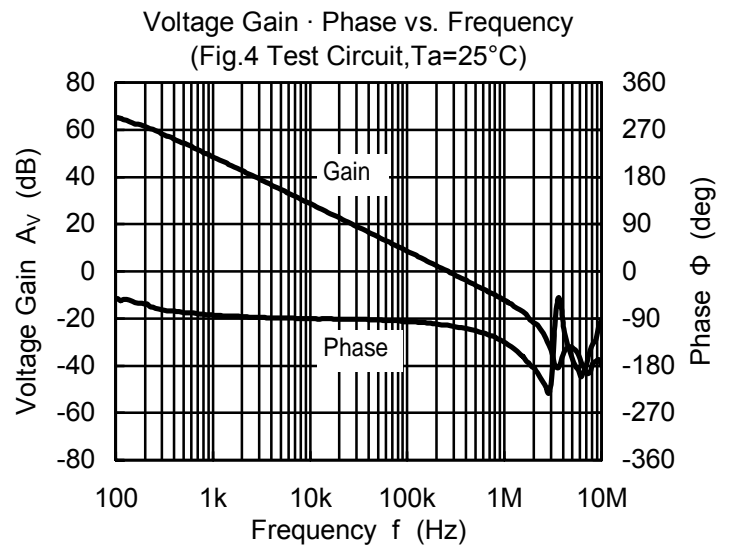
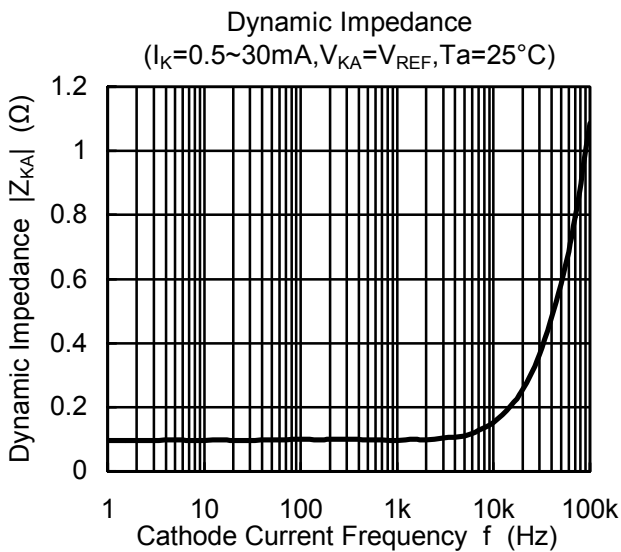
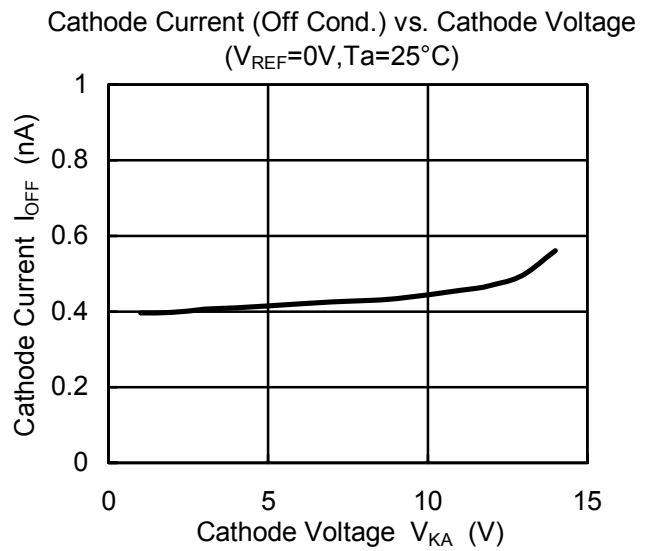
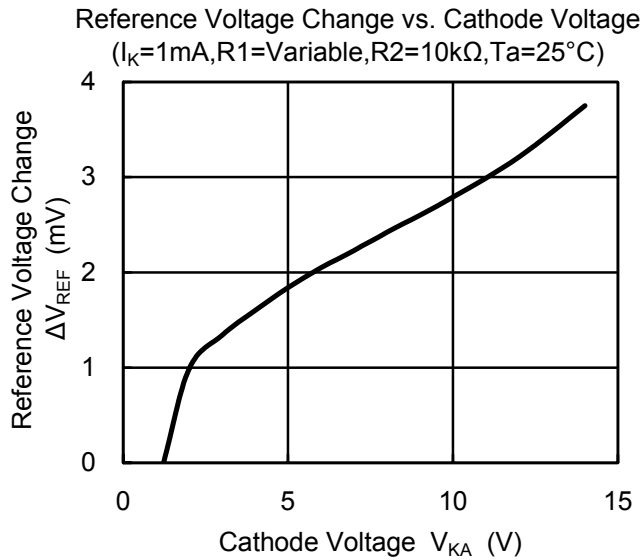
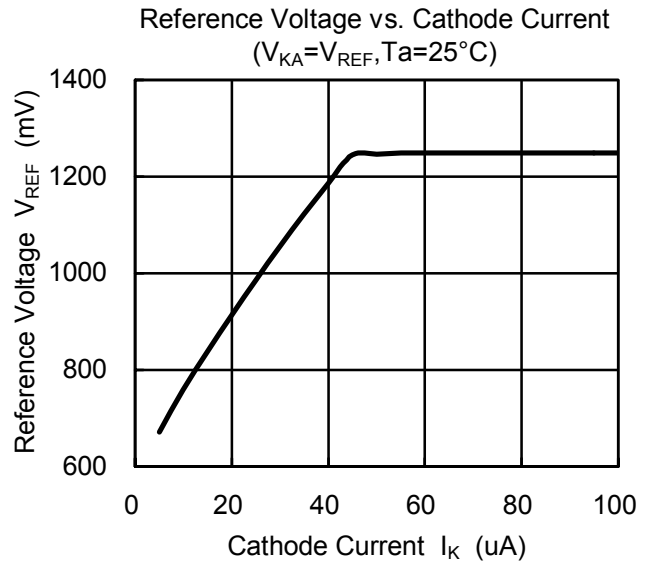
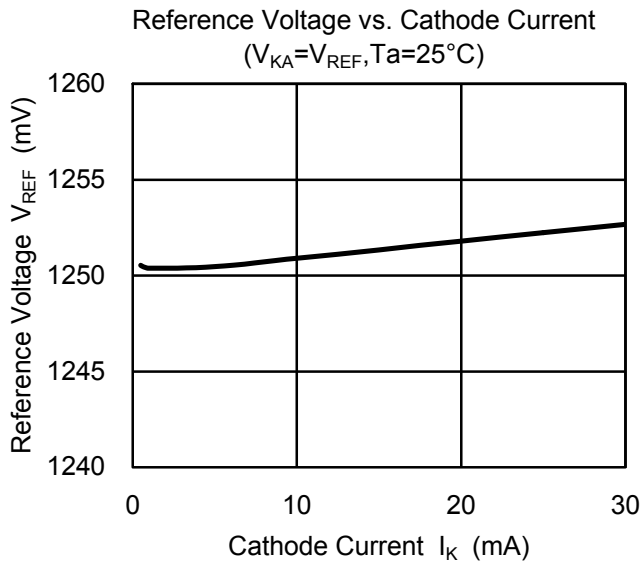

■ TYPICAL CHARACTERISTICS

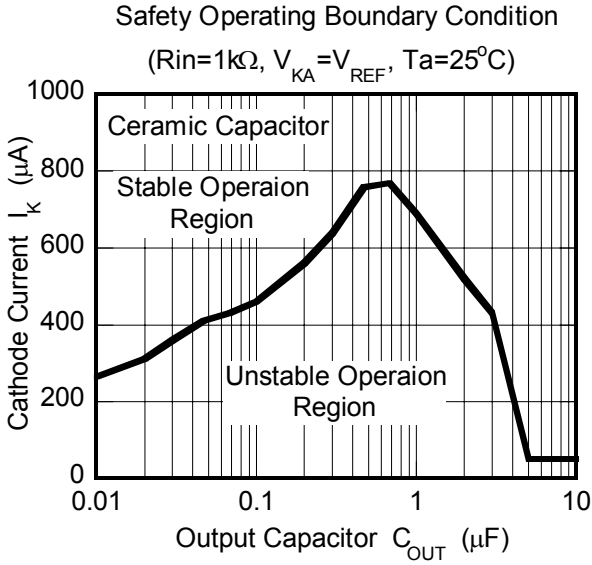

Safety Operating Boundary Condition  
Test Circuit

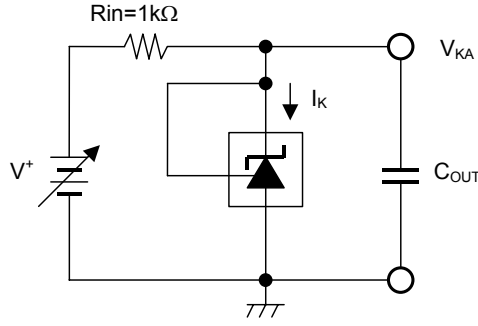

Note) Oscillation might occur while operating within the range of safety curve.  
So that, it is necessary to make ample margins by taking considerations of fluctuation of the device.

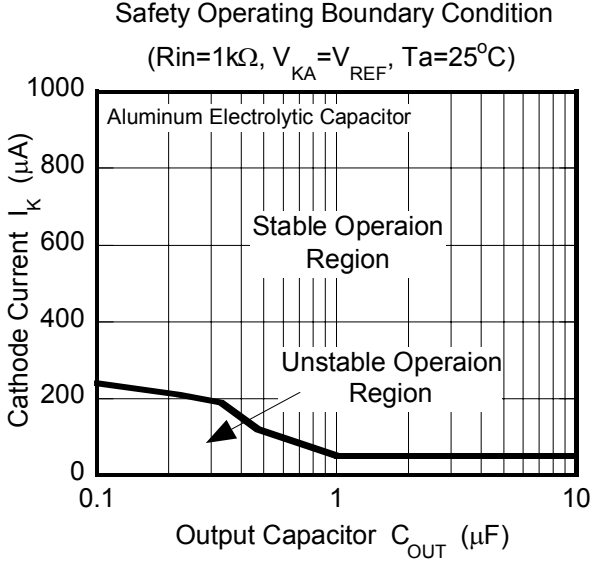

# NJM2373/73A/76

## ■ TYPICAL CHARACTERISTICS

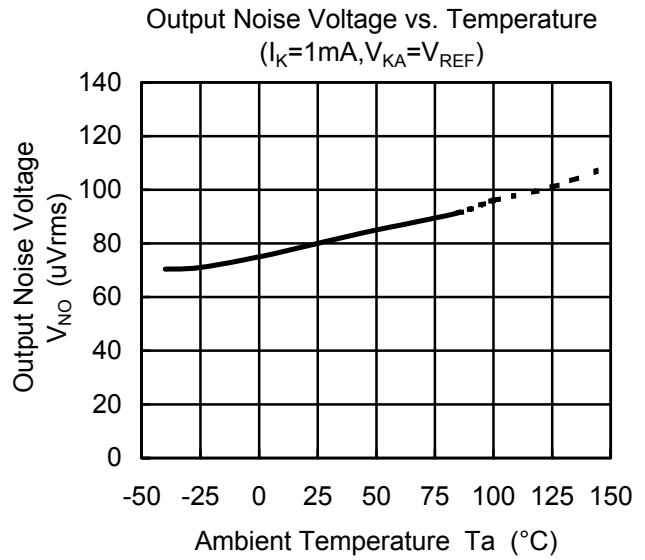
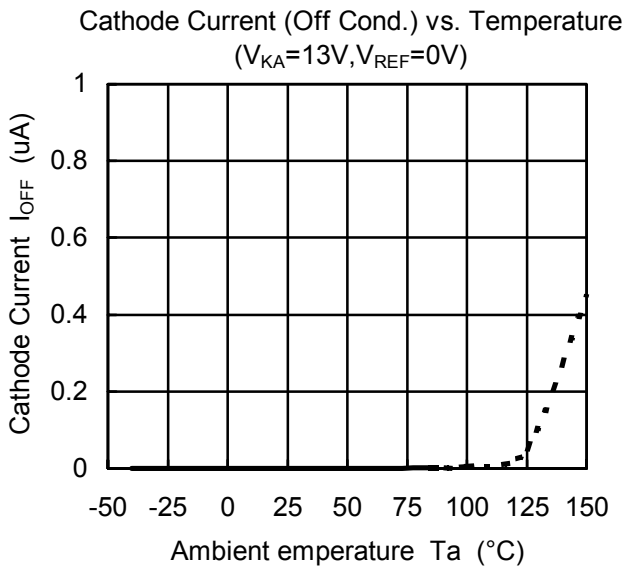
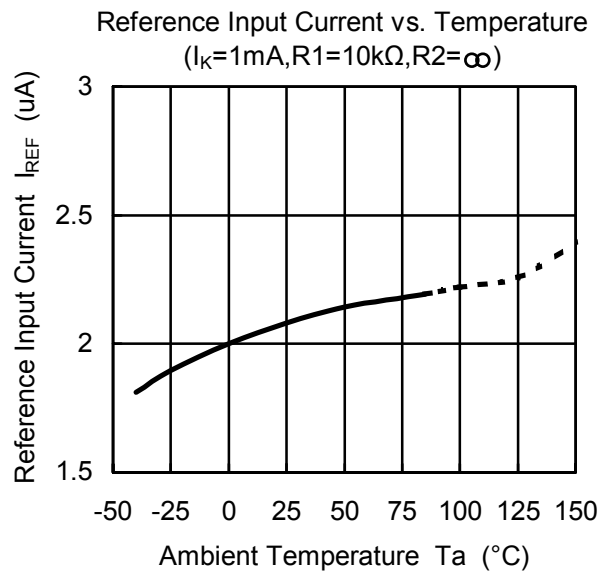
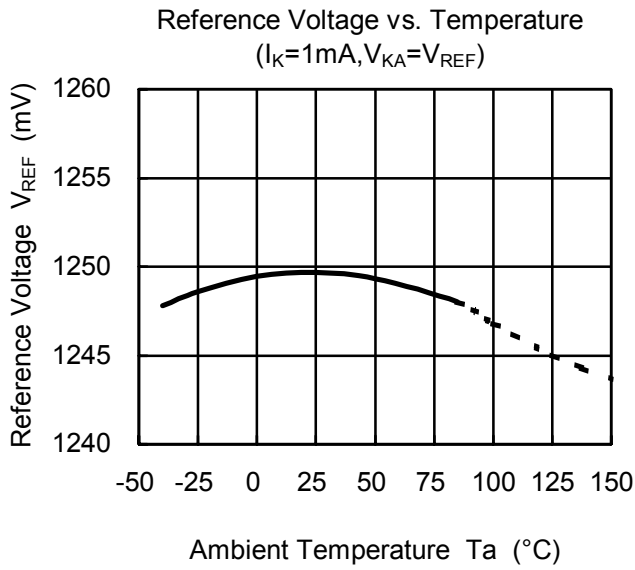

MEMO

[CAUTION]

The specifications on this databook are only given for information, without any guarantee as regards either mistakes or omissions. The application circuits in this databook are described only to show representative usages of the product and not intended for the guarantee or permission of any right including the industrial rights.

# Mouser Electronics

Authorized Distributor

Click to View Pricing, Inventory, Delivery & Lifecycle Information:

[Nisshinbo Micro Devices:](#)

[NJM2376U-TE1](#) [NJM2373AU-TE1](#) [NJM2376F-TE1](#) [NJM2373AF-TE1](#)