

## SPECIFICATIONS

**CUSTOMER** : \_\_\_\_\_  
**SAMPLE CODE** : SH720128T005ZBC  
**MASS PRODUCTION CODE** : PH720128T005ZBC  
**SAMPLE VERSION** : 01  
**SPECIFICATIONS EDITION** : 001  
**DRAWING NO. (Ver.)** : LMD- PH720128T005ZBC (Ver.001)  
**PACKAGING NO. (Ver.)** : PKG- PH720128T005ZBC (Ver.001)

**Customer Approved**

**Date:**

Approved	Checked	Designer
黃秋源 Oliver Huang	石建莊 Stone Shin	劉俊毅 Terry Liu

- Preliminary specification for design input  
 Specification for sample approval



### POWERTIP TECH. CORP.

**Headquarters:**

No.8, 6<sup>th</sup> Road, Taichung Industrial Park,  
Taichung, Taiwan  
台中市 407 工業區六路 8 號

TEL: 886-4-2355-8168  
FAX: 886-4-2355-8166

E-mail: [sales@powertip.com.tw](mailto:sales@powertip.com.tw)  
[Http://www.powertip.com.tw](http://www.powertip.com.tw)

## History of Version

Date <small>(mm / dd / yyyy)</small>	Ver.	Edi.	Description	Page	Design by
07/20/2019	01	001	New Sample	-	Terry

## Contents

### 1. SPECIFICATIONS

- 1.1 Features
- 1.2 Mechanical Specifications
- 1.3 Absolute Maximum Ratings
- 1.4 DC Electrical Characteristics
- 1.5 Optical Characteristics
- 1.6 Backlight Characteristics
- 1.7 Touch Panel Characteristics

### 2. MODULE STRUCTURE

- 2.1 Counter Drawing
- 2.2 Interface Pin Description
- 2.3 AC Characteristics
- 2.4 Refer Initial Code

### 3. QUALITY ASSURANCE SYSTEM

- 3.1 Quality Assurance Flow Chart
- 3.2 Inspection Specification

### 4. RELIABILITY TEST

- 4.1 Reliability Test Condition

### 5. PRECAUTION RELATING PRODUCT HANDLING

- 5.1 Safety
- 5.2 Handling
- 5.3 Storage
- 5.4 Terms of Warranty

Appendix : LCM Drawing.  
PKG Drawing

## 1. SPECIFICATIONS

### 1.1 Features

Item	Standard Value
Display Type	720 * (RGB) * 1280
LCD Type	Full Viewing Angle, Normally Black , Transmissive type
Touch panel	True Multi-Touch Capacitive Touch Panel True Multi-touch with up to 5 Points of Absolution
Screen size(Inch)	7.0 Inch
Backlight Type	LED B/L
Weight	170g
Control IC	ILI9881C (TFT Unit)
Interface	MIPI Interface (TFT Unit)
ROHS	THIS PRODUCT CONFORMS THE ROHS OF PTC Detail information please refer website : <a href="http://www.powertip.com.tw/news_detail.php?Key=1&amp;cID=1">http://www.powertip.com.tw/news_detail.php?Key=1&amp;cID=1</a>

### 1.2 Mechanical Specifications

Item	Standard Value	Unit
Outline Dimension	120.24 (W) * 189.32 (L) * 5.36(H)	mm
Viewing Area	87.74 (W) * 155.36 (L)	mm
Active Area	86.94 (W) * 154.56 (L)	mm

Note : For detailed information please refer to LCM drawing.

### 1.3 Absolute Maximum Ratings

Item	Symbol	Condition	Min.	Max.	Unit	Remark
Supply Voltage	VDD	GND=0	-0.3	+3.8	V	-
	VCI		-0.3	+7.0	V	
Operating Temperature	T <sub>OP</sub>	-	-20	+70	°C	
Storage Temperature	T <sub>ST</sub>	-	-30	+80	°C	

### 1.4 DC Electrical Characteristics

GND = 0V, Ta = 25 °C

Item	Symbol	Min.	Typ.	Max.	Unit	Remark
Supply Voltage	VDD	3.0	3.3	3.6	V	Note2
	VCI	3.0	3.3	3.6		
Input signal Voltage	V <sub>IH</sub>	0.7*VDD	-	VDD		
	V <sub>IL</sub>	-0.3	-	0.3*VDD		
	V <sub>OH</sub>	0.8*VDD	-	VDD		
	V <sub>OL</sub>	0	-	0.2*VDD		
Supply Current	I <sub>VDD</sub>	-	20mA	35mA		Note1
	I <sub>VCI</sub>	-	25mA	50mA		Note1

Note1: Maximum current display.

Note2 :For DSI DC level please refer to driver IC ILI9881C Specifications

## 1.5 Optical Characteristics

VDD= 3.3 V, Ta=25 °C

Item	Symbol	Condition	Min.	Typ.	Max.	unit		
Response time	Tr +Tf	Ta = 25 °C $\theta X, \theta Y = 0^\circ$	-	35	40	ms	Note 2	
Viewing angle	Top	$\theta Y+$	CR $\geq 10$	-	80	-	Deg.	Note 4
	Bottom	$\theta Y-$		-	80	-		
	Left	$\theta X-$		-	80	-		
	Right	$\theta X+$		-	80	-		
Contrast ratio	CR		650	800	-		Note 3	
Color of CIE Coordinate ( With B/L & touch panel )	White	X	Ta = 25 °C $\theta X, \theta Y = 0^\circ$	0.255	0.305	0.355	-	Note1
		Y		0.305	0.355	0.405		
	Red	X		0.595	0.645	0.695		
		Y		0.283	0.332	0.382		
	Green	X		0.258	0.308	0.358		
		Y		0.566	0.616	0.666		
	Blue	X		0.082	0.132	0.182		
		Y		0.005	0.055	0.105		
Average Brightness Pattern=white display ( With B/L & touch panel ) *2	IV	IF=90mA	430	500	-	cd/m <sup>2</sup>	Note1	
Uniformity ( With B/L & touch panel ) *1	$\Delta B$		70	-	-	%	Note1	

Note 1:

\*1 :  $\Delta B = B(\min) / B(\max) * 100\%$

\*2 : Measurement Condition for Optical Characteristics:

- a : Environment:  $25^{\circ}\text{C} \pm 5^{\circ}\text{C}$  /  $60 \pm 20\% \text{R.H}$  , no wind , dark room below 10 Lux at typical lamp current and typical operating frequency.
- b : Measurement Distance:  $500 \pm 50 \text{ mm}$  , ( $\theta = 0^{\circ}$ )
- c : Equipment: TOPCON BM-7 fast , (field  $1^{\circ}$ ) , after 10 minutes operation.
- d : The uncertainty of the C.I.E coordinate measurement  $\pm 0.01$  , Average Brightness  $\pm 4\%$

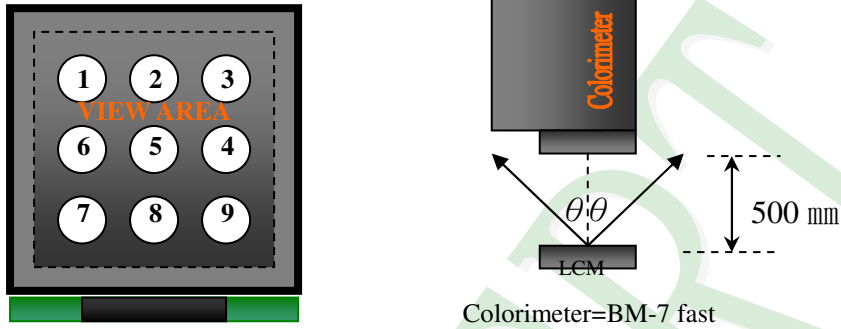

To be measured at the center area of panel with a viewing cone of  $1^{\circ}$  by Topcon luminance meter BM-7, after 10 minutes operation (module)

Note2: Definition of response time:

The output signals of photo detector are measured when the input signals are changed from "black" to "white"(falling time) and from "white" to "black"(rising time), respectively. The response time is defined as the time interval between the 10% and 90% of Amplitudes.

Refer to figure as below:

Normally White



### Normally Black

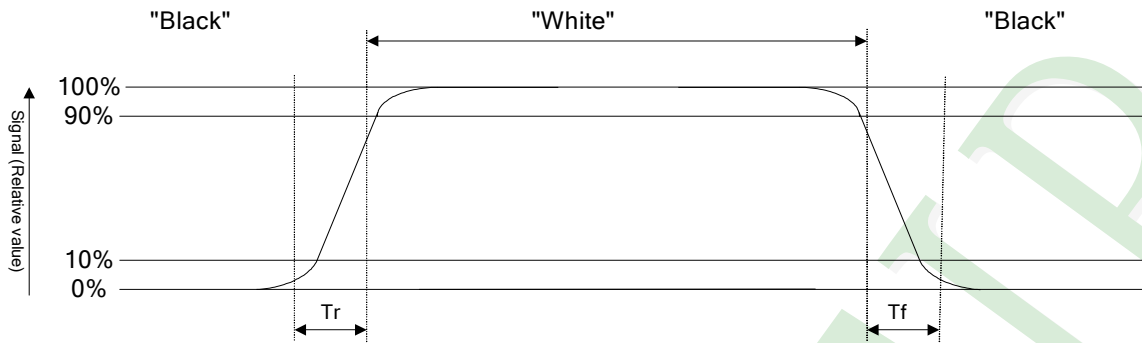

Note3: Definition of contrast ratio:

Contrast ratio is calculated with the following formula

$$\text{Contrast ratio (CR)} = \frac{\text{Photo detector output when LCD is at "White" state}}{\text{Photo detector output when LCD is at "Black" state}}$$

Note4: Definition of viewing angle:

Refer to figure as below:

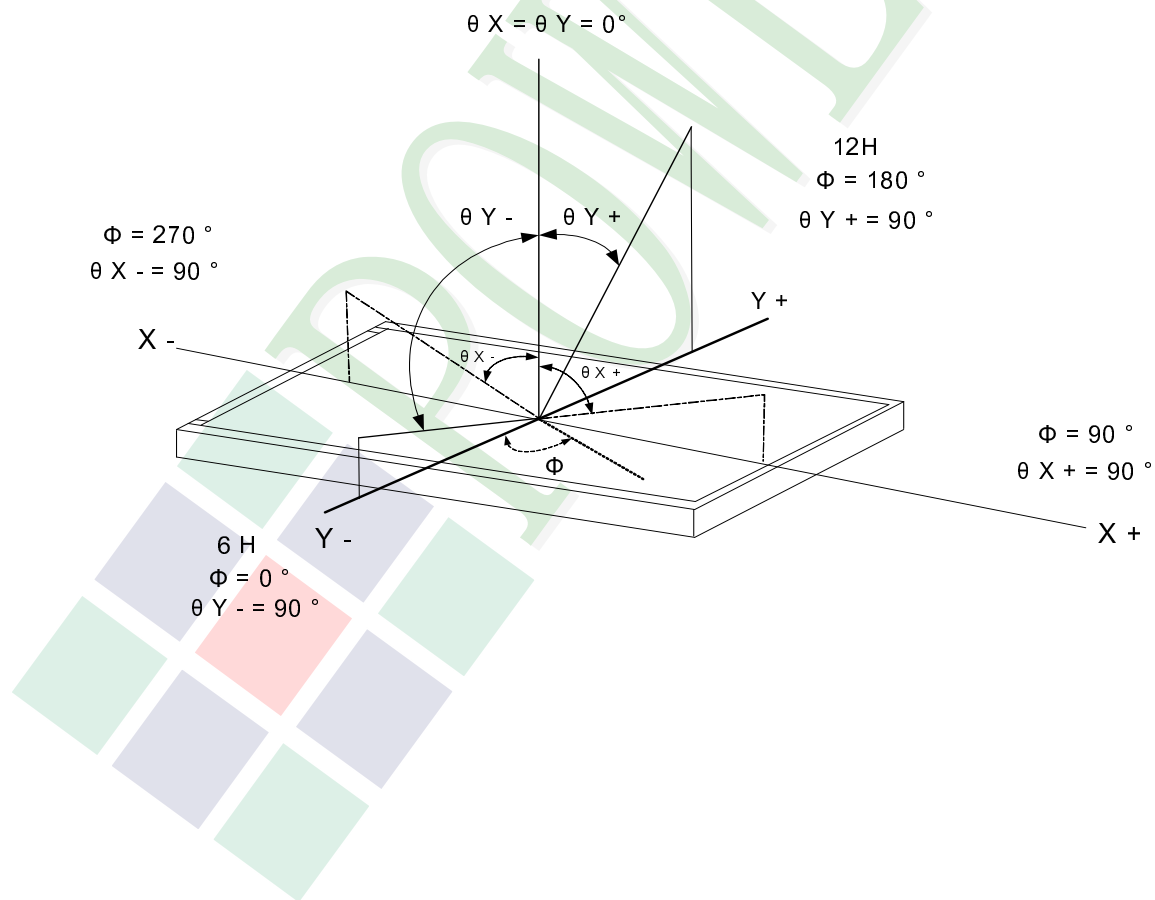



## 1.6 Backlight Characteristics

### Electrical / Optical Characteristics

Item	Symbol	Min.	Typ.	Max.	Unit	Remark
Forward Voltage	$V_f$	16.2	19.2	21.0	V	Ta=25°C IF=90mA
Life time	-	20000	-	-	H <sub>r</sub>	

LED Backlight Circuit:

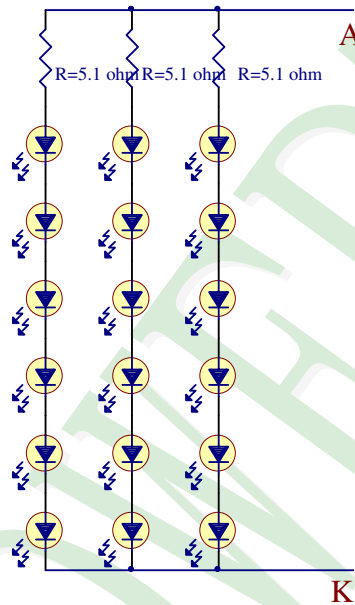

## 1.7 Touch Panel Characteristics

Item	Standard Value
Touch Panel Size	7"
Touch type	Projective Capacitive Touch Panel
Input Method	True Multi-touch with up to 5 Points of Absolution X and Y Coordinates
IC	GT911
Output Interface	I2C
I2C Address	0XBA

### I<sup>2</sup>C Address

Bit 7	Bit 6	Bit 5	Bit 4	Bit 3	Bit 2	Bit 1	Bit 0
1	0	1	1	1	0	1	<b>R/W</b>

Bit 0: 0 for Write / 1 for Read

## Mechanical Specifications

Item	Standard Value	Unit
Viewing Area	87.74 (W) * 155.36 (L)	mm
Number of sensing channel	25(TX) * 15 (RX)	

## Absolute Maximum Ratings

Item	Symbol	Condition	Min.	Max.	Unit
Supply voltage	TPVDD	-	7.7	+3.4	V
Operating Temperature	T <sub>OP</sub>	-	-20	+70	°C
Storage Temperature	T <sub>ST</sub>	-	-30	+80	°C

## DC Electrical Characteristics

Item	Symbol	Condition	Min.	Typ.	Max.	Unit
Power Supply Voltage	TPVDD	Ta=25°C	2.8	3.3	3.6	V
Input High Voltage	VIH		0.7 * TPVDD	-	TPVDD	V
Input Low Voltage	VIL		-0.3	-	0.3* TPVDD	V

## I<sup>2</sup>C Timing

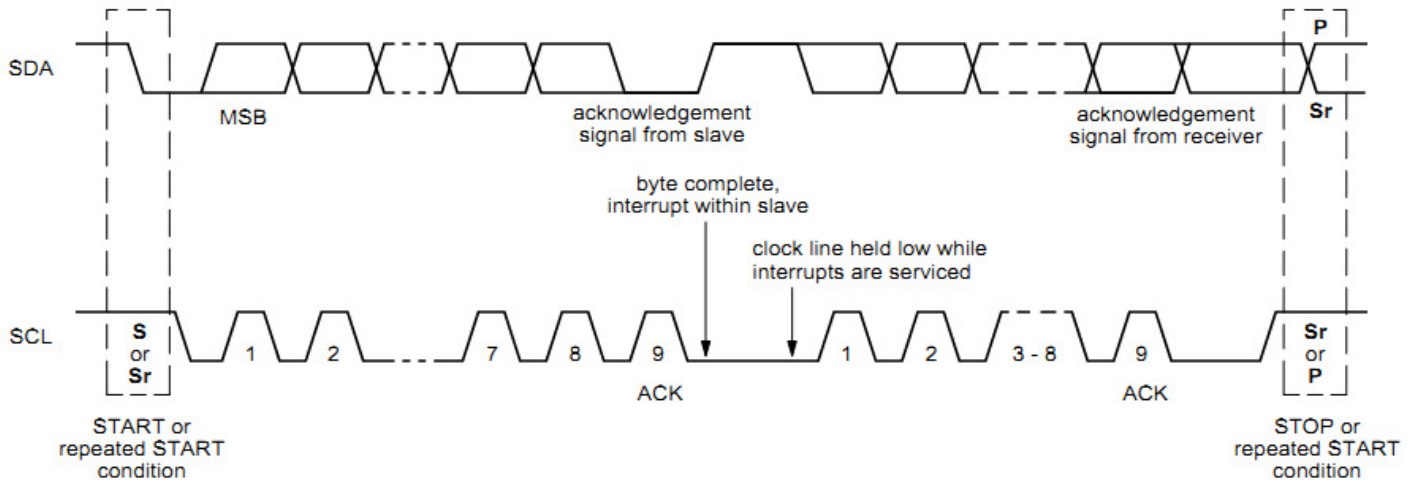

## I<sup>2</sup>C Write Interface description

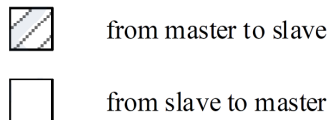
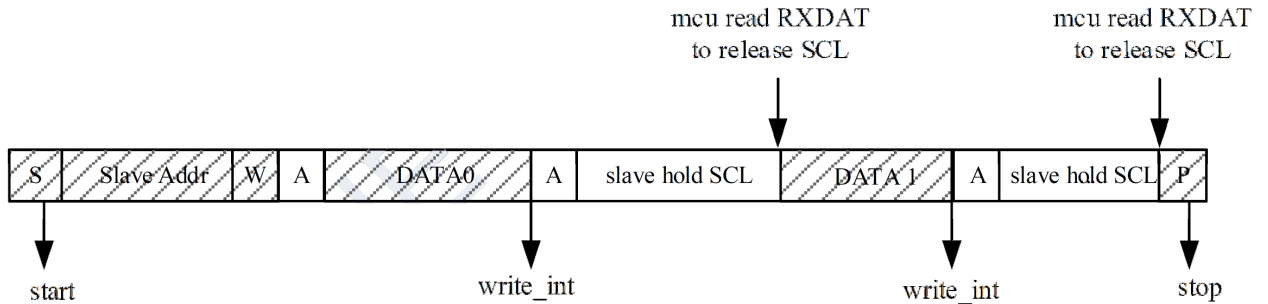

A = acknowledge (SDA LOW)  
 A = not acknowledge (SDA HIGH)  
 S = START condition  
 P = STOP condition

## I<sup>2</sup>C Read Interface description

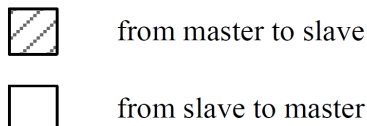
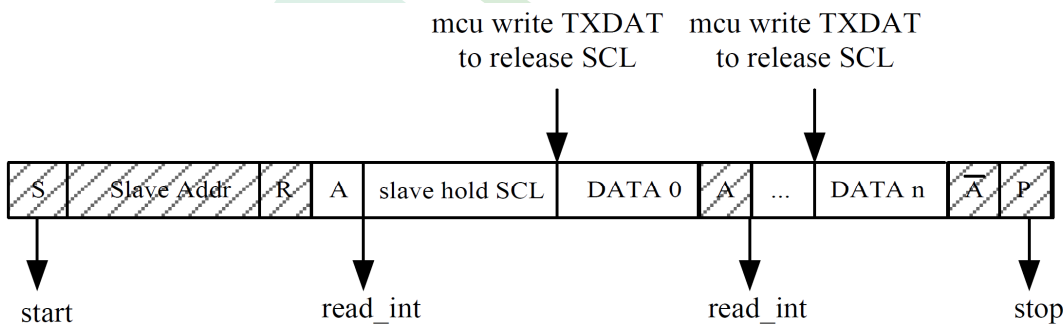

A = acknowledge (SDA LOW)  
A = not acknowledge (SDA HIGH)  
 S = START condition  
 P = STOP condition

## 2. MODULE STRUCTURE

### 2.1 Counter Drawing

#### 2.1.1 LCM Mechanical Diagram

\* See Appendix

#### 2.1.2 Block Diagram

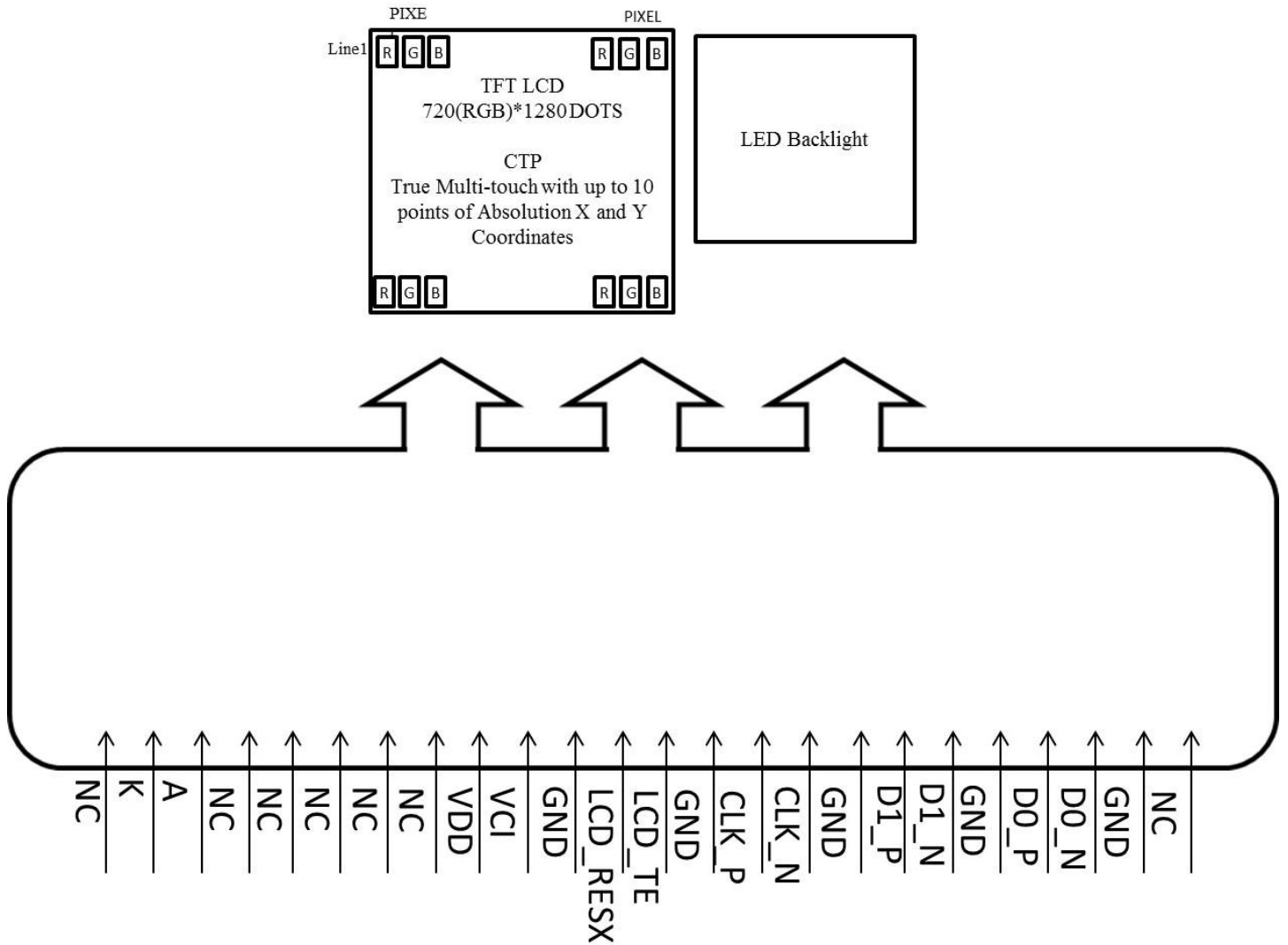

## 2.2 Interface Pin Description

### Interface for TFT display :

Pin#	Name	DESCRIPTION
1	NC	No connection.
2	K	Power for LED backlight cathode input.
3	A	Power for LED backlight anode input.
4	NC	No connection.
5	NC	No connection.
6	GND	Ground
7	NC	No connection.
8	NC	No connection.
9	VDD	Power supply for internal logic regulator.
10	VCI	Power supply for analog circuit.
11	GND	Ground.
12	LCD_RESX	The external reset input Initializes the chip with a low input. Be sure to execute a power-on reset after supplying power.
13	LCD_TE	Tearing effect output pin.
14	GND	Ground.
15	CLK_P	MIPI DSI differential clock pair
16	CLK_N	MIPI DSI differential clock pair
17	GND	Ground.
18	D1_P	MIPI DSI differential data pair. (Data lane 1)
19	D1_N	MIPI DSI differential data pair. (Data lane 1)
20	GND	Ground.
21	D0_P	MIPI DSI differential data pair. (Data lane 0)
22	D0_N	MIPI DSI differential data pair. (Data lane 0)
23	GND	Ground.
24	NC	No connection.

**Interface for CTP:**

Pin#	Name	DESCRIPTION
1	RST	RESET.
2	SCL	I2C Data.
3	SDA	I2C Data.
4	INT	The interrupt from the CTP to the Host.
5	TPVDD	Power.
6	GND	Ground.

## 2.3 AC Electrical Characteristics

### Timing for DSI video mode

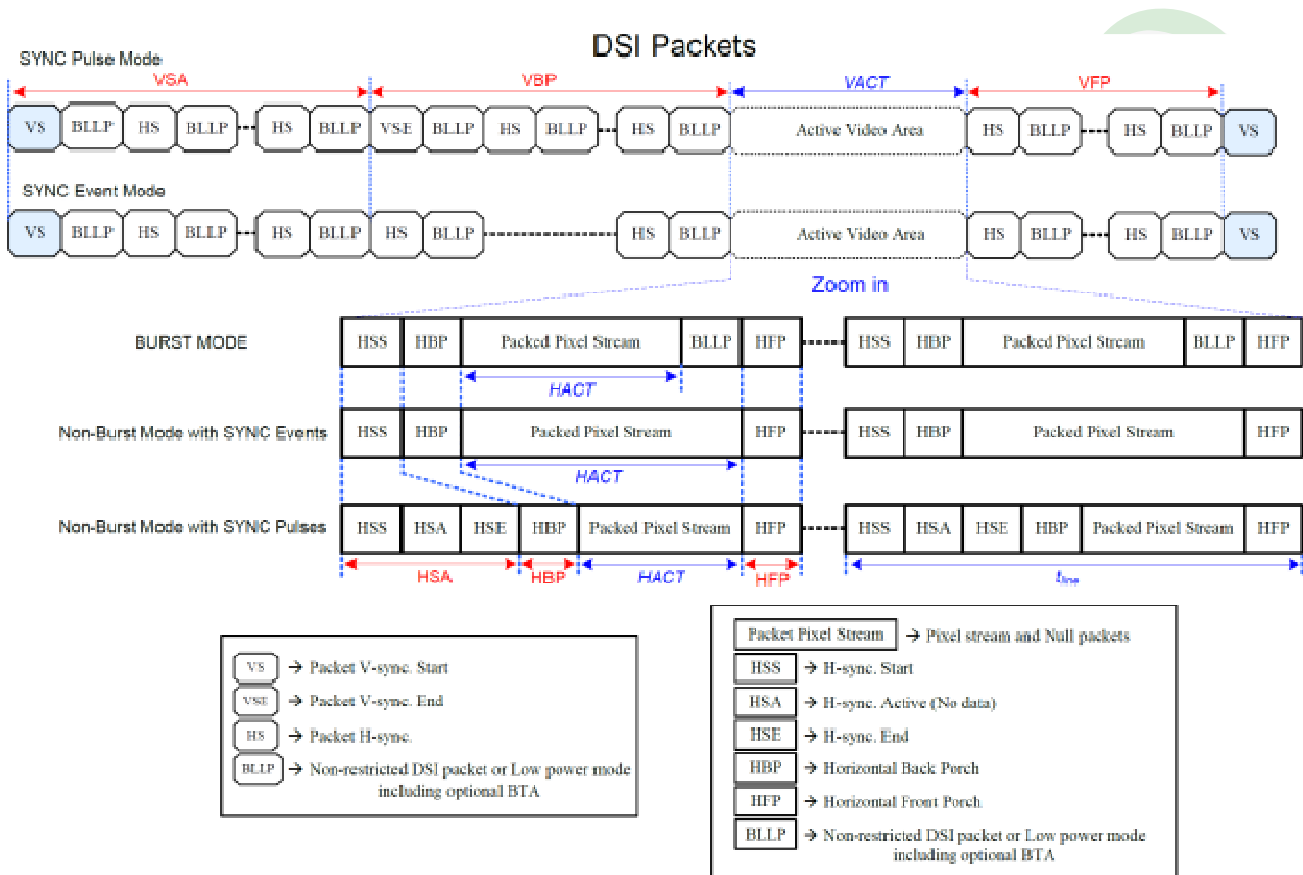

Parameters	Symbols	Min.	Typ.	Max.	Units
Vertical sync. active	VSA	2 <small>(Note 6)</small>	-	-	Line
Vertical Back Porch	VBP	14 <small>(Note 6)</small>	-	-	Line
Vertical Front Porch	VFP	8 <small>(Note 6)</small>	-	-	Line
Active lines per frame	VACT	-	1280	-	Line
Horizontal sync. active	HSA	2	-	-	Pixel
Horizontal Porch period	HSA + HBP + HFP	1.6	-	-	us
Active pixels per line	HACT	-	720	-	Pixel
Bit rate	BR <sub>bps</sub>	385		Note 5	Mbps/lane

1 UI=1/Bit rate

$HSA(\text{pixel}) = (tHSA \times \text{lane number}) / (UI \times \text{pixel format})$

$HBP(\text{pixel}) = (tHBP \times \text{lane number}) / (UI \times \text{pixel format})$

$HFP(\text{pixel}) = (tHFP \times \text{lane number}) / (UI \times \text{pixel format})$

$$\text{Frame Rate} = \frac{BR_{\text{bps}} \times \text{Lane}_{\text{num}}}{(VACT+VSA+VBP+VFP) \times (HACT+HSA+HBP+HFP) \times \text{Pixel Format}}$$

Example : BR<sub>bps</sub> = 457Mbps/lane, 1UI=2.1883ns, Frame rate=60Hz, VACT=1280, VSA=2, VBP=30, VFP=20, HACT=720, HSA=33, HBP=100, HFP=100, Lane<sub>num</sub>=4(lane), Pixel Format=24(bit).

**Note:**

1. Lane<sub>num</sub>: Data lane of MIPI-DSI.
2. Pixel Format: Please reference to “4.1 DSI System Interface”.
3. The formula exists slightly error because of the host-transmission way.
4. The best frame rate setting : 2 data lanes : 50~60 Hz / 3 data lanes : 50~70 Hz / 4 data lanes : 50~70 Hz.
5. Please reference to “Table 39: Limited Clock Channel Speed”.
6. The minimum values of this table mean the limitation of IC without considering the panel GIP. The actual values of VSA, VBP and VFP will be changed by different panel GIP setting.

## 2.4 Refer Initial Code

```
Void ILI9881C_HSD070FHW1-D_(C0700)_3H_Initial Code(Void)
```

```
{// IOVCC=1.8V //VSP=5.5 VSN=-5.5 External
```

```
//***** Reset LCD Driver *****//
```

```
LCD_nRESET = 1;
```

```
Delaysms(1); // Delay 1ms
```

```
LCD_nRESET = 0;
```

```
Delaysms(1); // Delay 1ms // This Delay time is necessary
```

```
LCD_nRESET = 1;
```

```
Delaysms(10); // Delay 120 ms
```

```
//***** Start Initial Sequence *****//
```

```
LCD_ILI9881C_CMD(0xFF);
```

```
LCD_ILI9881C_INDEX(0x98);
```

```
LCD_ILI9881C_INDEX(0x81);
```

```
LCD_ILI9881C_INDEX(0x03);
```

```
LCD_ILI9881C_CMD(0x01);
```

```
LCD_ILI9881C_INDEX(0x00);
```

```
LCD_ILI9881C_CMD(0x02);
```

```
LCD_ILI9881C_INDEX(0x00);
```

```
LCD_ILI9881C_CMD(0x03);
```

```
LCD_ILI9881C_INDEX(0x73);
```

```
LCD_ILI9881C_CMD(0x04);
```

```
LCD_ILI9881C_INDEX(0x00);
```

```
LCD_ILI9881C_CMD(0x05);
```

```
LCD_ILI9881C_INDEX(0x00);
```

```
LCD_ILI9881C_CMD(0x06);
```

```
LCD_ILI9881C_INDEX(0x0A);
```

```
LCD_ILI9881C_CMD(0x07);
```

```
LCD_ILI9881C_INDEX(0x00);
```



LCD\_ILI9881C\_CMD(0x08);  
LCD\_ILI9881C\_INDEX(0x00);  
LCD\_ILI9881C\_CMD(0x09);  
LCD\_ILI9881C\_INDEX(0x61);  
LCD\_ILI9881C\_CMD(0x0A);  
LCD\_ILI9881C\_INDEX(0x00);  
LCD\_ILI9881C\_CMD(0x0B);  
LCD\_ILI9881C\_INDEX(0x00);  
LCD\_ILI9881C\_CMD(0x0C);  
LCD\_ILI9881C\_INDEX(0x01);  
LCD\_ILI9881C\_CMD(0x0D);  
LCD\_ILI9881C\_INDEX(0x00);  
LCD\_ILI9881C\_CMD(0x0E);  
LCD\_ILI9881C\_INDEX(0x00);  
LCD\_ILI9881C\_CMD(0x0F);  
LCD\_ILI9881C\_INDEX(0x61);  
LCD\_ILI9881C\_CMD(0x10);  
LCD\_ILI9881C\_INDEX(0x61);  
LCD\_ILI9881C\_CMD(0x11);  
LCD\_ILI9881C\_INDEX(0x00);  
LCD\_ILI9881C\_CMD(0x12);  
LCD\_ILI9881C\_INDEX(0x00);  
LCD\_ILI9881C\_CMD(0x13);  
LCD\_ILI9881C\_INDEX(0x00);  
LCD\_ILI9881C\_CMD(0x14);  
LCD\_ILI9881C\_INDEX(0x00);  
LCD\_ILI9881C\_CMD(0x15);  
LCD\_ILI9881C\_INDEX(0x00);  
LCD\_ILI9881C\_CMD(0x16);  
LCD\_ILI9881C\_INDEX(0x00);  
LCD\_ILI9881C\_CMD(0x17);  
LCD\_ILI9881C\_INDEX(0x00);  
LCD\_ILI9881C\_CMD(0x18);  
LCD\_ILI9881C\_INDEX(0x00);  
LCD\_ILI9881C\_CMD(0x19);  
LCD\_ILI9881C\_INDEX(0x00);  
LCD\_ILI9881C\_CMD(0x1A);  
LCD\_ILI9881C\_INDEX(0x00);  
LCD\_ILI9881C\_CMD(0x1B);

LCD\_ILI9881C\_INDEX(0x00);  
LCD\_ILI9881C\_CMD(0x1C);  
LCD\_ILI9881C\_INDEX(0x00);  
LCD\_ILI9881C\_CMD(0x1D);  
LCD\_ILI9881C\_INDEX(0x00);  
LCD\_ILI9881C\_CMD(0x1E);  
LCD\_ILI9881C\_INDEX(0x40);  
LCD\_ILI9881C\_CMD(0x1F);  
LCD\_ILI9881C\_INDEX(0x80);  
LCD\_ILI9881C\_CMD(0x20);  
LCD\_ILI9881C\_INDEX(0x06);  
LCD\_ILI9881C\_CMD(0x21);  
LCD\_ILI9881C\_INDEX(0x01);  
LCD\_ILI9881C\_CMD(0x22);  
LCD\_ILI9881C\_INDEX(0x00);  
LCD\_ILI9881C\_CMD(0x23);  
LCD\_ILI9881C\_INDEX(0x00);  
LCD\_ILI9881C\_CMD(0x24);  
LCD\_ILI9881C\_INDEX(0x00);  
LCD\_ILI9881C\_CMD(0x25);  
LCD\_ILI9881C\_INDEX(0x00);  
LCD\_ILI9881C\_CMD(0x26);  
LCD\_ILI9881C\_INDEX(0x00);  
LCD\_ILI9881C\_CMD(0x27);  
LCD\_ILI9881C\_INDEX(0x00);  
LCD\_ILI9881C\_CMD(0x28);  
LCD\_ILI9881C\_INDEX(0x33);  
LCD\_ILI9881C\_CMD(0x29);  
LCD\_ILI9881C\_INDEX(0x03);  
LCD\_ILI9881C\_CMD(0x2A);  
LCD\_ILI9881C\_INDEX(0x00);  
LCD\_ILI9881C\_CMD(0x2B);  
LCD\_ILI9881C\_INDEX(0x00);  
LCD\_ILI9881C\_CMD(0x2C);  
LCD\_ILI9881C\_INDEX(0x00);  
LCD\_ILI9881C\_CMD(0x2D);  
LCD\_ILI9881C\_INDEX(0x00);  
LCD\_ILI9881C\_CMD(0x2E);  
LCD\_ILI9881C\_INDEX(0x00);

LCD\_ILI9881C\_CMD(0x2F);  
LCD\_ILI9881C\_INDEX(0x00);  
LCD\_ILI9881C\_CMD(0x30);  
LCD\_ILI9881C\_INDEX(0x00);  
LCD\_ILI9881C\_CMD(0x31);  
LCD\_ILI9881C\_INDEX(0x00);  
LCD\_ILI9881C\_CMD(0x32);  
LCD\_ILI9881C\_INDEX(0x00);  
LCD\_ILI9881C\_CMD(0x33);  
LCD\_ILI9881C\_INDEX(0x00);  
LCD\_ILI9881C\_CMD(0x34);  
LCD\_ILI9881C\_INDEX(0x04);  
LCD\_ILI9881C\_CMD(0x35);  
LCD\_ILI9881C\_INDEX(0x00);  
LCD\_ILI9881C\_CMD(0x36);  
LCD\_ILI9881C\_INDEX(0x00);  
LCD\_ILI9881C\_CMD(0x37);  
LCD\_ILI9881C\_INDEX(0x00);  
LCD\_ILI9881C\_CMD(0x38);  
LCD\_ILI9881C\_INDEX(0x3C);  
LCD\_ILI9881C\_CMD(0x39);  
LCD\_ILI9881C\_INDEX(0x00);  
LCD\_ILI9881C\_CMD(0x3A);  
LCD\_ILI9881C\_INDEX(0x00);  
LCD\_ILI9881C\_CMD(0x3B);  
LCD\_ILI9881C\_INDEX(0x00);  
LCD\_ILI9881C\_CMD(0x3C);  
LCD\_ILI9881C\_INDEX(0x00);  
LCD\_ILI9881C\_CMD(0x3D);  
LCD\_ILI9881C\_INDEX(0x00);  
LCD\_ILI9881C\_CMD(0x3E);  
LCD\_ILI9881C\_INDEX(0x00);  
LCD\_ILI9881C\_CMD(0x3F);  
LCD\_ILI9881C\_INDEX(0x00);  
LCD\_ILI9881C\_CMD(0x40);  
LCD\_ILI9881C\_INDEX(0x00);  
LCD\_ILI9881C\_CMD(0x41);  
LCD\_ILI9881C\_INDEX(0x00);  
LCD\_ILI9881C\_CMD(0x42);

LCD\_ILI9881C\_INDEX(0x00);  
LCD\_ILI9881C\_CMD(0x43);  
LCD\_ILI9881C\_INDEX(0x00);  
LCD\_ILI9881C\_CMD(0x44);  
LCD\_ILI9881C\_INDEX(0x00);  
LCD\_ILI9881C\_CMD(0x50);  
LCD\_ILI9881C\_INDEX(0x10);  
LCD\_ILI9881C\_CMD(0x51);  
LCD\_ILI9881C\_INDEX(0x32);  
LCD\_ILI9881C\_CMD(0x52);  
LCD\_ILI9881C\_INDEX(0x54);  
LCD\_ILI9881C\_CMD(0x53);  
LCD\_ILI9881C\_INDEX(0x76);  
LCD\_ILI9881C\_CMD(0x54);  
LCD\_ILI9881C\_INDEX(0x98);  
LCD\_ILI9881C\_CMD(0x55);  
LCD\_ILI9881C\_INDEX(0xBA);  
LCD\_ILI9881C\_CMD(0x56);  
LCD\_ILI9881C\_INDEX(0x10);  
LCD\_ILI9881C\_CMD(0x57);  
LCD\_ILI9881C\_INDEX(0x32);  
LCD\_ILI9881C\_CMD(0x58);  
LCD\_ILI9881C\_INDEX(0x54);  
LCD\_ILI9881C\_CMD(0x59);  
LCD\_ILI9881C\_INDEX(0x76);  
LCD\_ILI9881C\_CMD(0x5A);  
LCD\_ILI9881C\_INDEX(0x98);  
LCD\_ILI9881C\_CMD(0x5B);  
LCD\_ILI9881C\_INDEX(0xBA);  
LCD\_ILI9881C\_CMD(0x5C);  
LCD\_ILI9881C\_INDEX(0xDC);  
LCD\_ILI9881C\_CMD(0x5D);  
LCD\_ILI9881C\_INDEX(0xFE);  
LCD\_ILI9881C\_CMD(0x5E);  
LCD\_ILI9881C\_INDEX(0x00);  
LCD\_ILI9881C\_CMD(0x5F);  
LCD\_ILI9881C\_INDEX(0x0E);  
LCD\_ILI9881C\_CMD(0x60);  
LCD\_ILI9881C\_INDEX(0x0F);

LCD\_ILI9881C\_CMD(0x61);  
LCD\_ILI9881C\_INDEX(0x0C);  
LCD\_ILI9881C\_CMD(0x62);  
LCD\_ILI9881C\_INDEX(0x0D);  
LCD\_ILI9881C\_CMD(0x63);  
LCD\_ILI9881C\_INDEX(0x06);  
LCD\_ILI9881C\_CMD(0x64);  
LCD\_ILI9881C\_INDEX(0x07);  
LCD\_ILI9881C\_CMD(0x65);  
LCD\_ILI9881C\_INDEX(0x02);  
LCD\_ILI9881C\_CMD(0x66);  
LCD\_ILI9881C\_INDEX(0x02);  
LCD\_ILI9881C\_CMD(0x67);  
LCD\_ILI9881C\_INDEX(0x02);  
LCD\_ILI9881C\_CMD(0x68);  
LCD\_ILI9881C\_INDEX(0x02);  
LCD\_ILI9881C\_CMD(0x69);  
LCD\_ILI9881C\_INDEX(0x01);  
LCD\_ILI9881C\_CMD(0x6A);  
LCD\_ILI9881C\_INDEX(0x00);  
LCD\_ILI9881C\_CMD(0x6B);  
LCD\_ILI9881C\_INDEX(0x02);  
LCD\_ILI9881C\_CMD(0x6C);  
LCD\_ILI9881C\_INDEX(0x15);  
LCD\_ILI9881C\_CMD(0x6D);  
LCD\_ILI9881C\_INDEX(0x14);  
LCD\_ILI9881C\_CMD(0x6E);  
LCD\_ILI9881C\_INDEX(0x02);  
LCD\_ILI9881C\_CMD(0x6F);  
LCD\_ILI9881C\_INDEX(0x02);  
LCD\_ILI9881C\_CMD(0x70);  
LCD\_ILI9881C\_INDEX(0x02);  
LCD\_ILI9881C\_CMD(0x71);  
LCD\_ILI9881C\_INDEX(0x02);  
LCD\_ILI9881C\_CMD(0x72);  
LCD\_ILI9881C\_INDEX(0x02);  
LCD\_ILI9881C\_CMD(0x73);  
LCD\_ILI9881C\_INDEX(0x02);  
LCD\_ILI9881C\_CMD(0x74);

LCD\_ILI9881C\_INDEX(0x02);  
LCD\_ILI9881C\_CMD(0x75);  
LCD\_ILI9881C\_INDEX(0x0E);  
LCD\_ILI9881C\_CMD(0x76);  
LCD\_ILI9881C\_INDEX(0x0F);  
LCD\_ILI9881C\_CMD(0x77);  
LCD\_ILI9881C\_INDEX(0x0C);  
LCD\_ILI9881C\_CMD(0x78);  
LCD\_ILI9881C\_INDEX(0x0D);  
LCD\_ILI9881C\_CMD(0x79);  
LCD\_ILI9881C\_INDEX(0x06);  
LCD\_ILI9881C\_CMD(0x7A);  
LCD\_ILI9881C\_INDEX(0x07);  
LCD\_ILI9881C\_CMD(0x7B);  
LCD\_ILI9881C\_INDEX(0x02);  
LCD\_ILI9881C\_CMD(0x7C);  
LCD\_ILI9881C\_INDEX(0x02);  
LCD\_ILI9881C\_CMD(0x7D);  
LCD\_ILI9881C\_INDEX(0x02);  
LCD\_ILI9881C\_CMD(0x7E);  
LCD\_ILI9881C\_INDEX(0x02);  
LCD\_ILI9881C\_CMD(0x7F);  
LCD\_ILI9881C\_INDEX(0x01);  
LCD\_ILI9881C\_CMD(0x80);  
LCD\_ILI9881C\_INDEX(0x00);  
LCD\_ILI9881C\_CMD(0x81);  
LCD\_ILI9881C\_INDEX(0x02);  
LCD\_ILI9881C\_CMD(0x82);  
LCD\_ILI9881C\_INDEX(0x14);  
LCD\_ILI9881C\_CMD(0x83);  
LCD\_ILI9881C\_INDEX(0x15);  
LCD\_ILI9881C\_CMD(0x84);  
LCD\_ILI9881C\_INDEX(0x02);  
LCD\_ILI9881C\_CMD(0x85);  
LCD\_ILI9881C\_INDEX(0x02);  
LCD\_ILI9881C\_CMD(0x86);  
LCD\_ILI9881C\_INDEX(0x02);  
LCD\_ILI9881C\_CMD(0x87);  
LCD\_ILI9881C\_INDEX(0x02);

LCD\_ILI9881C\_CMD(0x88);  
LCD\_ILI9881C\_INDEX(0x02);  
LCD\_ILI9881C\_CMD(0x89);  
LCD\_ILI9881C\_INDEX(0x02);  
LCD\_ILI9881C\_CMD(0x8A);  
LCD\_ILI9881C\_INDEX(0x02);  
LCD\_ILI9881C\_CMD(0xFF);  
LCD\_ILI9881C\_INDEX(0x98);  
LCD\_ILI9881C\_INDEX(0x81);  
LCD\_ILI9881C\_INDEX(0x04);  
LCD\_ILI9881C\_CMD(0x6C);  
LCD\_ILI9881C\_INDEX(0x15);  
LCD\_ILI9881C\_CMD(0x6E);  
LCD\_ILI9881C\_INDEX(0x2A);  
LCD\_ILI9881C\_CMD(0x6F);  
LCD\_ILI9881C\_INDEX(0x33);  
LCD\_ILI9881C\_CMD(0x3A);  
LCD\_ILI9881C\_INDEX(0x94);  
LCD\_ILI9881C\_CMD(0x8D);  
LCD\_ILI9881C\_INDEX(0x14);  
LCD\_ILI9881C\_CMD(0x87);  
LCD\_ILI9881C\_INDEX(0xBA);  
LCD\_ILI9881C\_CMD(0x26);  
LCD\_ILI9881C\_INDEX(0x76);  
LCD\_ILI9881C\_CMD(0xB2);  
LCD\_ILI9881C\_INDEX(0xD1);  
LCD\_ILI9881C\_CMD(0xB5);  
LCD\_ILI9881C\_INDEX(0x06);  
LCD\_ILI9881C\_CMD(0x38);  
LCD\_ILI9881C\_INDEX(0x01);  
LCD\_ILI9881C\_CMD(0x39);  
LCD\_ILI9881C\_INDEX(0x00);  
LCD\_ILI9881C\_CMD(0xFF);  
LCD\_ILI9881C\_INDEX(0x98);  
LCD\_ILI9881C\_INDEX(0x81);  
LCD\_ILI9881C\_INDEX(0x01);  
LCD\_ILI9881C\_CMD(0x22);  
LCD\_ILI9881C\_INDEX(0x0A);  
LCD\_ILI9881C\_CMD(0x31);

LCD\_ILI9881C\_INDEX(0x00);  
LCD\_ILI9881C\_CMD(0x53);  
LCD\_ILI9881C\_INDEX(0x7D);  
LCD\_ILI9881C\_CMD(0x55);  
LCD\_ILI9881C\_INDEX(0x8F);  
LCD\_ILI9881C\_CMD(0x40);  
LCD\_ILI9881C\_INDEX(0x33);  
LCD\_ILI9881C\_CMD(0x50);  
LCD\_ILI9881C\_INDEX(0x96);  
LCD\_ILI9881C\_CMD(0x51);  
LCD\_ILI9881C\_INDEX(0x96);  
LCD\_ILI9881C\_CMD(0x60);  
LCD\_ILI9881C\_INDEX(0x23);  
LCD\_ILI9881C\_CMD(0xA0);  
LCD\_ILI9881C\_INDEX(0x08);  
LCD\_ILI9881C\_CMD(0xA1);  
LCD\_ILI9881C\_INDEX(0x1D);  
LCD\_ILI9881C\_CMD(0xA2);  
LCD\_ILI9881C\_INDEX(0x2A);  
LCD\_ILI9881C\_CMD(0xA3);  
LCD\_ILI9881C\_INDEX(0x10);  
LCD\_ILI9881C\_CMD(0xA4);  
LCD\_ILI9881C\_INDEX(0x15);  
LCD\_ILI9881C\_CMD(0xA5);  
LCD\_ILI9881C\_INDEX(0x28);  
LCD\_ILI9881C\_CMD(0xA6);  
LCD\_ILI9881C\_INDEX(0x1C);  
LCD\_ILI9881C\_CMD(0xA7);  
LCD\_ILI9881C\_INDEX(0x1D);  
LCD\_ILI9881C\_CMD(0xA8);  
LCD\_ILI9881C\_INDEX(0x7E);  
LCD\_ILI9881C\_CMD(0xA9);  
LCD\_ILI9881C\_INDEX(0x1D);  
LCD\_ILI9881C\_CMD(0xAA);  
LCD\_ILI9881C\_INDEX(0x29);  
LCD\_ILI9881C\_CMD(0xAB);  
LCD\_ILI9881C\_INDEX(0x6B);  
LCD\_ILI9881C\_CMD(0xAC);  
LCD\_ILI9881C\_INDEX(0x1A);



LCD\_ILI9881C\_CMD(0xAD);  
LCD\_ILI9881C\_INDEX(0x18);  
LCD\_ILI9881C\_CMD(0xAE);  
LCD\_ILI9881C\_INDEX(0x4B);  
LCD\_ILI9881C\_CMD(0xAF);  
LCD\_ILI9881C\_INDEX(0x20);  
LCD\_ILI9881C\_CMD(0xB0);  
LCD\_ILI9881C\_INDEX(0x27);  
LCD\_ILI9881C\_CMD(0xB1);  
LCD\_ILI9881C\_INDEX(0x50);  
LCD\_ILI9881C\_CMD(0xB2);  
LCD\_ILI9881C\_INDEX(0x64);  
LCD\_ILI9881C\_CMD(0xB3);  
LCD\_ILI9881C\_INDEX(0x39);  
LCD\_ILI9881C\_CMD(0xC0);  
LCD\_ILI9881C\_INDEX(0x08);  
LCD\_ILI9881C\_CMD(0xC1);  
LCD\_ILI9881C\_INDEX(0x1D);  
LCD\_ILI9881C\_CMD(0xC2);  
LCD\_ILI9881C\_INDEX(0x2A);  
LCD\_ILI9881C\_CMD(0xC3);  
LCD\_ILI9881C\_INDEX(0x10);  
LCD\_ILI9881C\_CMD(0xC4);  
LCD\_ILI9881C\_INDEX(0x15);  
LCD\_ILI9881C\_CMD(0xC5);  
LCD\_ILI9881C\_INDEX(0x28);  
LCD\_ILI9881C\_CMD(0xC6);  
LCD\_ILI9881C\_INDEX(0x1C);  
LCD\_ILI9881C\_CMD(0xC7);  
LCD\_ILI9881C\_INDEX(0x1D);  
LCD\_ILI9881C\_CMD(0xC8);  
LCD\_ILI9881C\_INDEX(0x7E);  
LCD\_ILI9881C\_CMD(0xC9);  
LCD\_ILI9881C\_INDEX(0x1D);  
LCD\_ILI9881C\_CMD(0xCA);  
LCD\_ILI9881C\_INDEX(0x29);  
LCD\_ILI9881C\_CMD(0xCB);  
LCD\_ILI9881C\_INDEX(0x6B);  
LCD\_ILI9881C\_CMD(0xCC);

```
LCD_ILI9881C_INDEX(0x1A);
LCD_ILI9881C_CMD(0xCD);
LCD_ILI9881C_INDEX(0x18);
LCD_ILI9881C_CMD(0xCE);
LCD_ILI9881C_INDEX(0x4B);
LCD_ILI9881C_CMD(0xCF);
LCD_ILI9881C_INDEX(0x20);
LCD_ILI9881C_CMD(0xD0);
LCD_ILI9881C_INDEX(0x27);
LCD_ILI9881C_CMD(0xD1);
LCD_ILI9881C_INDEX(0x50);
LCD_ILI9881C_CMD(0xD2);
LCD_ILI9881C_INDEX(0x64);
LCD_ILI9881C_CMD(0xD3);
LCD_ILI9881C_INDEX(0x39);
LCD_ILI9881C_CMD(0xFF);
LCD_ILI9881C_INDEX(0x98);
LCD_ILI9881C_INDEX(0x81);
LCD_ILI9881C_INDEX(0x00);
LCD_ILI9881C_CMD(0x35);
LCD_ILI9881C_INDEX(0x00);
Void ILI9881C_ExitSleep_Code(Void)
{
LCD_ILI9881C_CMD(0x11); // Sleep Out
Delays(120);
LCD_ILI9881C_CMD(0x29) //Display on
Delays(20);
}
```

### 3. QUALITY ASSURANCE SYSTEM

#### 3.1 Quality Assurance Flow Chart

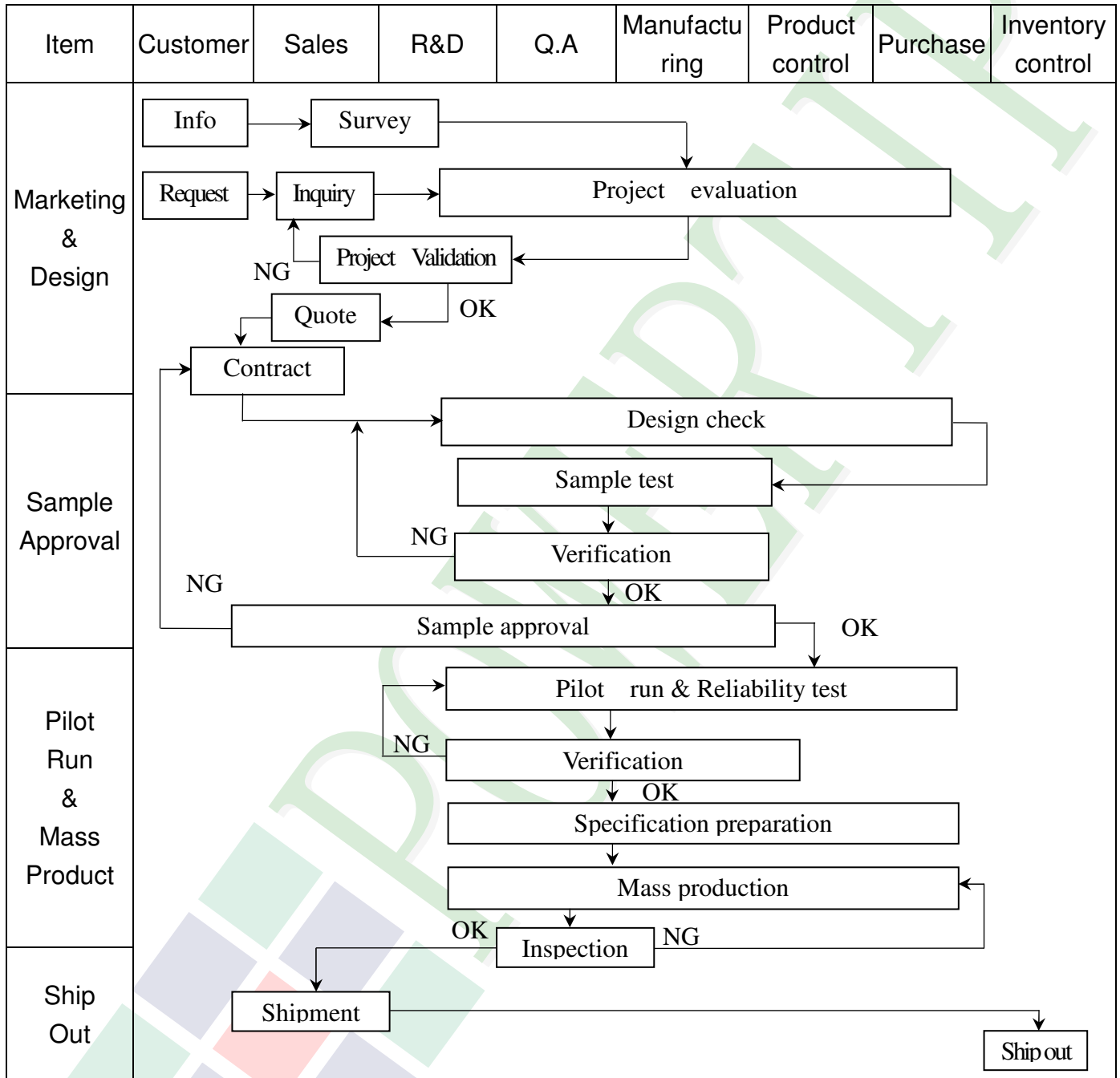

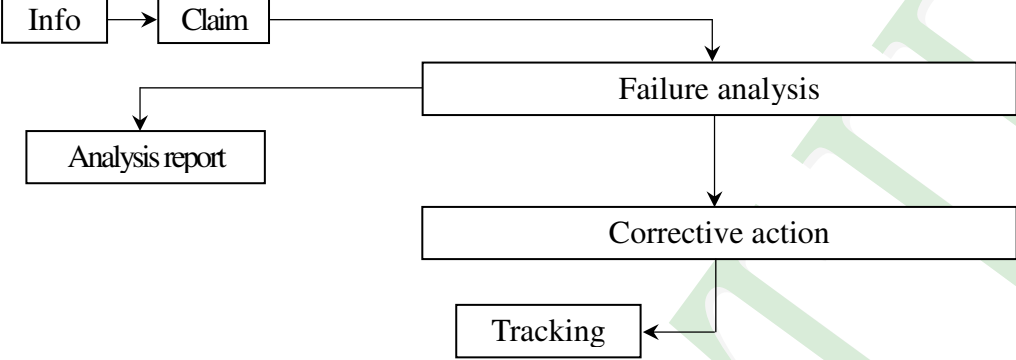
Item	Customer	Sales	R&D	Q.A	Manufacturing	Product control	Purchase	Inventory control
Sales Service	 <pre> graph TD     Info[Info] --&gt; Claim[Claim]     Claim --&gt; Failure[Failure analysis]     Failure --&gt; Report[Analysis report]     Failure --&gt; Action[Corrective action]     Action --&gt; Tracking[Tracking]           </pre>							
Q.A Activity	1. ISO 9001 Maintenance Activities 3. Equipment calibration 5. Standardization Management				2. Process improvement proposal 4. Education And Training Activities			

### 3.2. Inspection Specification

- ◆ **Scope:** The document shall be applied to TFT-LCD Module for 3.5" -15" (Ver.B01).
- ◆ **Inspection Standard:** MIL-STD-105E Table Normal Inspection Single Sampling Level II.
- ◆ **Equipment:** Gauge, MIL-STD, Powertip Tester, Sample
- ◆ **Defect Level:** Major Defect AQL: 0.4; Minor Defect AQL: 1.5
- ◆ **OUT Going Defect Level:** Sampling.
- ◆ **Standard of the product appearance test:**

**a. Manner of appearance test:**

- (1). The test best be under 20W×2 fluorescent light(about 300lux ~500lux), and distance of view must be at 30~40 cm.
- (2). The test direction is base on about around 45° of vertical line.

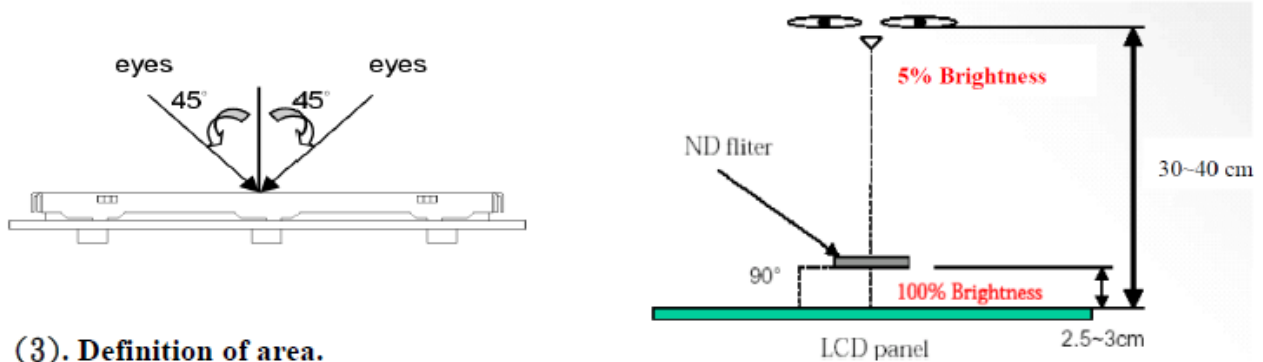

**(3). Definition of area.**

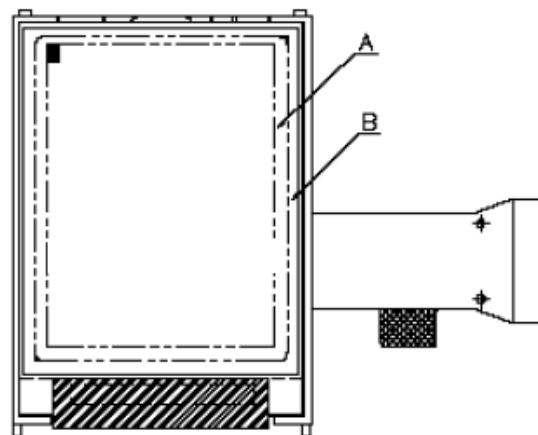

**A area: viewing area**

**B area: Outside of viewing area**

**(4). Standard of inspection : (Unit : mm)**

**◆ Specification For TFT-LCD Module 3.5" ~15" :**

(Ver.B01)

NO	Item	Criterion	Level												
01	Product condition	1. 1 The part number is inconsistent with work order of production.	Major												
		1. 2 Mixed product types.	Major												
		1. 3 Assembled in inverse direction.	Major												
02	Quantity	2. 1 The quantity is inconsistent with work order of production.	Major												
03	Outline dimension	3. 1 Product dimension and structure must conform to structure diagram.	Major												
04	Electrical Testing	4. 1 Missing line character and icon.	Major												
		4. 2 No function or no display.	Major												
		4. 3 Display malfunction.	Major												
		4. 4 LCD viewing angle defect.	Major												
		4. 5 Current consumption exceeds product specifications.	Major												
		4. 6 Mura cannot be seen through 5% ND filter at 50% Gray, should be judged by the viewing angle of 90 degree.	Minor												
05	Dot defect (Bright dot, Dark dot)  On -display	<table border="1" style="margin-left: auto; margin-right: auto;"> <thead> <tr> <th colspan="2">Item</th> <th>Acceptance (Q'ty)</th> </tr> </thead> <tbody> <tr> <td rowspan="4" style="text-align: center; vertical-align: middle;">Dot Defect</td> <td style="text-align: center;">Bright Dot</td> <td style="text-align: center;"><math>\leq 4</math></td> </tr> <tr> <td style="text-align: center;">Dark Dot</td> <td style="text-align: center;"><math>\leq 5</math></td> </tr> <tr> <td style="text-align: center;">Joint Dot</td> <td style="text-align: center;"><math>\leq 3</math></td> </tr> <tr> <td style="text-align: center;">Total</td> <td style="text-align: center;"><math>\leq 7</math></td> </tr> </tbody> </table>	Item		Acceptance (Q'ty)	Dot Defect	Bright Dot	$\leq 4$	Dark Dot	$\leq 5$	Joint Dot	$\leq 3$	Total	$\leq 7$	Minor
		Item		Acceptance (Q'ty)											
Dot Defect	Bright Dot	$\leq 4$													
	Dark Dot	$\leq 5$													
	Joint Dot	$\leq 3$													
	Total	$\leq 7$													
5. 1 Inspection pattern: full white, full black, Red, Green and blue screens. 5. 2 It is defined as dot defect if defect area $> 1/2$ dot. 5. 3 The distance between two dot defect $\geq 5$ mm. 5. 4 Bright dot that can not be seen through 5% ND filter.															

**◆ Specification For TFT-LCD Module 3.5" ~15" :**

(Ver.B01)

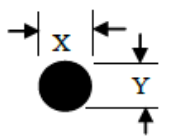
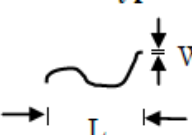
NO	Item	Criterion	Level																																																					
06	Black or white Dot, scratch, contamination  Round type  $\Phi = (x + y) / 2$  Line type 	6.1 Round type (Non-display or display):  <table border="1"> <thead> <tr> <th rowspan="2">Dimension (diameter : <math>\Phi</math>)</th> <th colspan="2">Acceptance (Q'ty)</th> </tr> <tr> <th>A area</th> <th>B area</th> </tr> </thead> <tbody> <tr> <td><math>\Phi \leq 0.25</math></td> <td colspan="2">Ignore</td> </tr> <tr> <td><math>0.25 &lt; \Phi \leq 0.50</math></td> <td>5</td> <td rowspan="3">Ignore</td> </tr> <tr> <td><math>\Phi &gt; 0.50</math></td> <td>0</td> </tr> <tr> <td><b>Total</b></td> <td>5</td> </tr> </tbody> </table>  6.2 Line type(Non-display or display):  <table border="1"> <thead> <tr> <th rowspan="2">module size</th> <th rowspan="2">Length (L)</th> <th rowspan="2">Width (W)</th> <th colspan="2">Acceptance (Q'ty)</th> </tr> <tr> <th>A area</th> <th>B area</th> </tr> </thead> <tbody> <tr> <td rowspan="5">3.5" to less 9"</td> <td>---</td> <td><math>W \leq 0.03</math></td> <td>Ignore</td> <td rowspan="5">Ignore</td> </tr> <tr> <td><math>L \leq 10.0</math></td> <td><math>0.03 &lt; W \leq 0.05</math></td> <td>4</td> </tr> <tr> <td><math>L \leq 5.0</math></td> <td><math>0.05 &lt; W \leq 0.10</math></td> <td>2</td> </tr> <tr> <td>---</td> <td><math>W &gt; 0.10</math></td> <td>As round type</td> </tr> <tr> <td colspan="2">Total</td> <td>5</td> </tr> <tr> <td rowspan="5">9" to 15"</td> <td>---</td> <td><math>W \leq 0.05</math></td> <td>Ignore</td> <td rowspan="5">Ignore</td> </tr> <tr> <td><math>L \leq 10.0</math></td> <td><math>0.05 &lt; W \leq 0.10</math></td> <td>5</td> </tr> <tr> <td>---</td> <td><math>W &gt; 0.10</math></td> <td>As round type</td> </tr> <tr> <td colspan="2">Total</td> <td>5</td> </tr> </tbody> </table>	Dimension (diameter : $\Phi$ )	Acceptance (Q'ty)		A area	B area	$\Phi \leq 0.25$	Ignore		$0.25 < \Phi \leq 0.50$	5	Ignore	$\Phi > 0.50$	0	<b>Total</b>	5	module size	Length (L)	Width (W)	Acceptance (Q'ty)		A area	B area	3.5" to less 9"	---	$W \leq 0.03$	Ignore	Ignore	$L \leq 10.0$	$0.03 < W \leq 0.05$	4	$L \leq 5.0$	$0.05 < W \leq 0.10$	2	---	$W > 0.10$	As round type	Total		5	9" to 15"	---	$W \leq 0.05$	Ignore	Ignore	$L \leq 10.0$	$0.05 < W \leq 0.10$	5	---	$W > 0.10$	As round type	Total		5	Minor
Dimension (diameter : $\Phi$ )	Acceptance (Q'ty)																																																							
	A area	B area																																																						
$\Phi \leq 0.25$	Ignore																																																							
$0.25 < \Phi \leq 0.50$	5	Ignore																																																						
$\Phi > 0.50$	0																																																							
<b>Total</b>	5																																																							
module size	Length (L)	Width (W)	Acceptance (Q'ty)																																																					
			A area	B area																																																				
3.5" to less 9"	---	$W \leq 0.03$	Ignore	Ignore																																																				
	$L \leq 10.0$	$0.03 < W \leq 0.05$	4																																																					
	$L \leq 5.0$	$0.05 < W \leq 0.10$	2																																																					
	---	$W > 0.10$	As round type																																																					
	Total		5																																																					
9" to 15"	---	$W \leq 0.05$	Ignore	Ignore																																																				
	$L \leq 10.0$	$0.05 < W \leq 0.10$	5																																																					
	---	$W > 0.10$	As round type																																																					
	Total		5																																																					
	07	Polarizer Bubble	<table border="1"> <thead> <tr> <th rowspan="2">Dimension (diameter: <math>\Phi</math>)</th> <th colspan="2">Acceptance (Q'ty)</th> </tr> <tr> <th>A area</th> <th>B area</th> </tr> </thead> <tbody> <tr> <td><math>\Phi \leq 0.25</math></td> <td>Ignore</td> <td rowspan="5">Ignore</td> </tr> <tr> <td><math>0.25 &lt; \Phi \leq 0.50</math></td> <td>4</td> </tr> <tr> <td><math>0.50 &lt; \Phi \leq 0.80</math></td> <td>1</td> </tr> <tr> <td><math>\Phi &gt; 0.80</math></td> <td>0</td> </tr> <tr> <td><b>Total</b></td> <td>5</td> </tr> </tbody> </table>		Dimension (diameter: $\Phi$ )	Acceptance (Q'ty)		A area	B area	$\Phi \leq 0.25$	Ignore	Ignore	$0.25 < \Phi \leq 0.50$	4	$0.50 < \Phi \leq 0.80$	1	$\Phi > 0.80$	0	<b>Total</b>	5	Minor																																			
Dimension (diameter: $\Phi$ )	Acceptance (Q'ty)																																																							
	A area	B area																																																						
$\Phi \leq 0.25$	Ignore	Ignore																																																						
$0.25 < \Phi \leq 0.50$	4																																																							
$0.50 < \Phi \leq 0.80$	1																																																							
$\Phi > 0.80$	0																																																							
<b>Total</b>	5																																																							

**◆ Specification For TFT-LCD Module 3.5" ~15" :**

(Ver.B01)

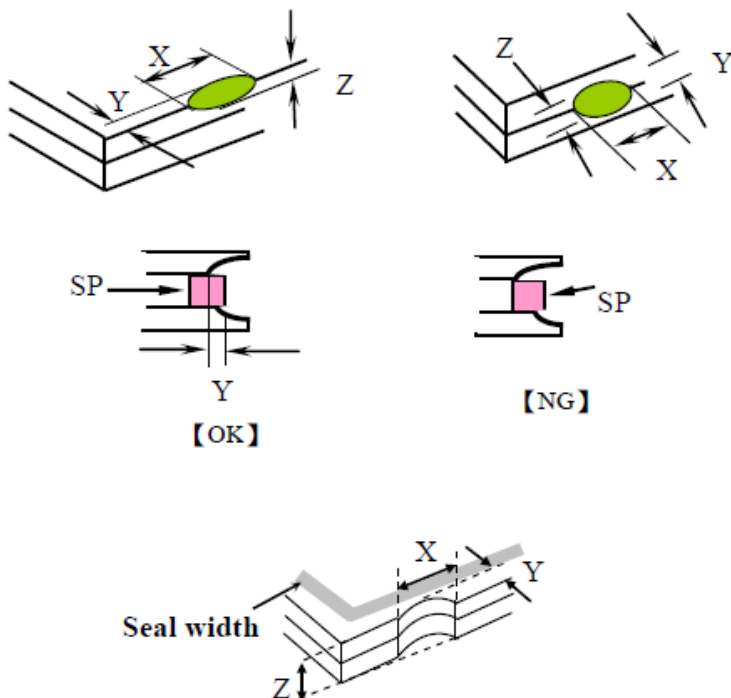

NO	Item	Criterion	Level						
08	The crack of glass	<p><b>Symbols :</b></p> <p><b>X:</b> The length of crack  <b>Z:</b> The thickness of crack  <b>t:</b> The thickness of glass</p> <p><b>Y:</b> The width of crack.  <b>W:</b> terminal length  <b>a:</b> LCD side length</p>	Minor						
		<p>8.1 General glass chip:</p> <p>8.1.1 Chip on panel surface and crack between panels:</p>  <table border="1" data-bbox="542 1523 1324 1803"> <thead> <tr> <th>X</th> <th>Y</th> <th>Z</th> </tr> </thead> <tbody> <tr> <td><math>\leq a</math></td> <td>Crack can't enter viewing area</td> <td><math>\leq 1/2 t</math></td> </tr> <tr> <td><math>\leq a</math></td> <td>Crack can't exceed the half of SP width.</td> <td><math>1/2 t &lt; Z \leq 2 t</math></td> </tr> </tbody> </table>		X	Y	Z	$\leq a$	Crack can't enter viewing area	$\leq 1/2 t$
X	Y	Z							
$\leq a$	Crack can't enter viewing area	$\leq 1/2 t$							
$\leq a$	Crack can't exceed the half of SP width.	$1/2 t < Z \leq 2 t$							

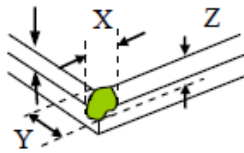
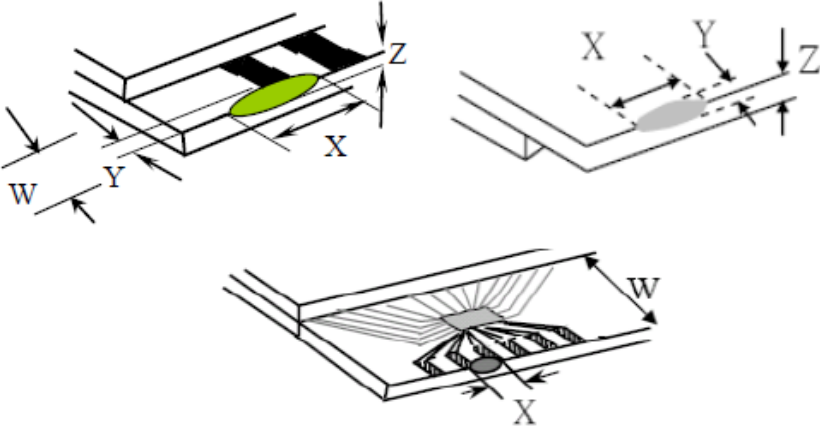

**◆ Specification For TFT-LCD Module 3.5" ~15" :**

(Ver.B01)

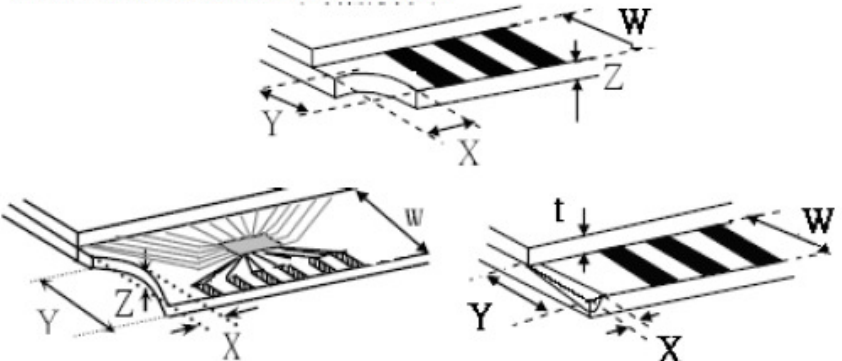
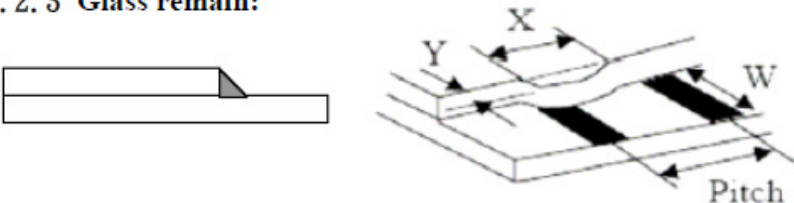
NO	Item	Criterion	Level												
08	The crack of glass	Symbols :  <b>X:</b> The length of crack <b>Z:</b> The thickness of crack <b>t:</b> The thickness of glass  <b>Y:</b> The width of crack. <b>W:</b> terminal length <b>a:</b> LCD side length	Minor												
		8.1.2 Corner crack:   <table border="1" data-bbox="528 757 1326 1048"> <thead> <tr> <th>X</th> <th>Y</th> <th>Z</th> </tr> </thead> <tbody> <tr> <td><math>\leq 1/5 a</math></td> <td>Crack can't enter viewing area</td> <td><math>Z \leq 1/2 t</math></td> </tr> <tr> <td><math>\leq 1/5 a</math></td> <td>Crack can't exceed the half of SP width.</td> <td><math>1/2 t &lt; Z \leq 2 t</math></td> </tr> </tbody> </table>		X	Y	Z	$\leq 1/5 a$	Crack can't enter viewing area	$Z \leq 1/2 t$	$\leq 1/5 a$	Crack can't exceed the half of SP width.	$1/2 t < Z \leq 2 t$			
X	Y	Z													
$\leq 1/5 a$	Crack can't enter viewing area	$Z \leq 1/2 t$													
$\leq 1/5 a$	Crack can't exceed the half of SP width.	$1/2 t < Z \leq 2 t$													
		8.2 Protrusion over terminal: 8.2.1 Chip on electrode pad:   <table border="1" data-bbox="563 1675 1337 1843"> <thead> <tr> <th></th> <th>X</th> <th>Y</th> <th>Z</th> </tr> </thead> <tbody> <tr> <td>Front</td> <td><math>\leq a</math></td> <td><math>\leq 1/2 W</math></td> <td><math>\leq t</math></td> </tr> <tr> <td>Back</td> <td><math>\leq a</math></td> <td><math>\leq W</math></td> <td><math>\leq 1/2 t</math></td> </tr> </tbody> </table>		X	Y	Z	Front	$\leq a$	$\leq 1/2 W$	$\leq t$	Back	$\leq a$	$\leq W$	$\leq 1/2 t$	
	X	Y	Z												
Front	$\leq a$	$\leq 1/2 W$	$\leq t$												
Back	$\leq a$	$\leq W$	$\leq 1/2 t$												

NO	Item	Criterion	Level												
08	The crack of glass	<p><b>Symbols:</b></p> <p><b>X:</b> The length of crack                      <b>Y:</b> The width of crack.  <b>Z:</b> The thickness of crack                  <b>W:</b> terminal length  <b>t:</b> The thickness of glass                   <b>a:</b> LCD side length</p> <p><b>8.2.2 Non-conductive portion:</b></p>  <table border="1" data-bbox="635 936 1246 1057"> <thead> <tr> <th>X</th> <th>Y</th> <th>Z</th> </tr> </thead> <tbody> <tr> <td><math>\leq 1/3 a</math></td> <td><math>\leq W</math></td> <td><math>\leq t</math></td> </tr> </tbody> </table> <p>⊙ If the chipped area touches the ITO terminal, over 2/3 of the ITO must remain and be inspected according to electrode terminal specifications.</p> <p><b>8.2.3 Glass remain:</b></p>  <table border="1" data-bbox="557 1473 1227 1594"> <thead> <tr> <th>X</th> <th>Y</th> <th>Z</th> </tr> </thead> <tbody> <tr> <td><math>\leq a</math></td> <td><math>\leq 1/3 W</math></td> <td><math>\leq t</math></td> </tr> </tbody> </table> <p><b>8.2.4 Cracking:</b></p>  <p style="text-align: center;"><b>Not Allowed</b></p>	X	Y	Z	$\leq 1/3 a$	$\leq W$	$\leq t$	X	Y	Z	$\leq a$	$\leq 1/3 W$	$\leq t$	Minor
X	Y	Z													
$\leq 1/3 a$	$\leq W$	$\leq t$													
X	Y	Z													
$\leq a$	$\leq 1/3 W$	$\leq t$													

**◆ Specification For TFT-LCD Module 3. 5" ~15" :**

(Ver.B01)

NO	Item	Criterion	Level
09	Backlight elements	9. 1 Backlight can't work normally.	Major
		9. 2 Backlight doesn't light or color is wrong.	Major
		9. 3 Illumination source flickers when lit.	Major
10	General appearance	10. 1 Pin type 、 quantity 、 dimension must match type in structure diagram.	Major
		10. 2 No short circuits in components on PCB or FPC.	Major
		10. 3 Parts on PCB or FPC must be: no wrong parts, missing parts or excess parts.	Major
		10. 4 Product packaging must the same as specified on packaging specification sheet.	Minor
		10. 5 The folding and peeled off in polarizer are not acceptable.	Minor
		10. 6 The PCB or FPC between B/L assembled distance(PCB or FPC ) is $\leq 1.5$ mm.	Minor

## 4. RELIABILITY TEST

### 4.1 Reliability Test Condition

(Ver.B01)

NO.	TEST ITEM	TEST CONDITION											
1	High Temperature Storage Test	Keep in <b>80 ±5°C</b> 240 hrs											
2	Low Temperature Storage Test	Keep in <b>-30 ±5°C</b> 240 hrs											
3	High Temperature / High Humidity Storage Test	Keep in <b>60 °C / 90% R.H</b> duration for 240 hrs (Excluding the polarizer)											
4	Temperature Cycling Storage Test	$-30^{\circ}\text{C} \xrightarrow{(30\text{mins})} +25^{\circ}\text{C} \xrightarrow{(5\text{mins})} 80^{\circ}\text{C} \xrightarrow{(30\text{mins})} +25^{\circ}\text{C} \xrightarrow{(5\text{mins})}$ ← 20 Cycle →											
5	ESD Test	<b>Air Discharge:</b> Apply <b>2 KV</b> with 5 times Discharge for each polarity +/-	<b>Contact Discharge:</b> Apply <b>250 V</b> with 5 times discharge for each polarity +/-										
		1. Temperature ambience : <b>15°C ~ 35°C</b> 2. Humidity relative : <b>30% ~ 60%</b> 3. Energy Storage Capacitance(Cs+Cd) : <b>150pF±10%</b> 4. Discharge Resistance(Rd) : <b>330Ω±10%</b> 5. Discharge, mode of operation : <b>Single Discharge</b> (time between successive discharges at least 1 sec) (Tolerance if the output voltage indication : <b>±5%</b> )											
6	Vibration Test (Packaged)	1. Sine wave <b>10~55 Hz</b> frequency (1 min/sweep) 2. The amplitude of vibration : <b>1.5 mm</b> 3. Each direction (X、Y、Z) duration for <b>2 Hrs</b>											
7	Drop Test (Packaged)	<table border="1"> <thead> <tr> <th>Packing Weight (Kg)</th> <th>Drop Height (cm)</th> </tr> </thead> <tbody> <tr> <td style="text-align: center;">0 ~ 45.4</td> <td style="text-align: center;">122</td> </tr> <tr> <td style="text-align: center;">45.4 ~ 90.8</td> <td style="text-align: center;">76</td> </tr> <tr> <td style="text-align: center;">90.8 ~ 454</td> <td style="text-align: center;">61</td> </tr> <tr> <td style="text-align: center;">Over 454</td> <td style="text-align: center;">46</td> </tr> </tbody> </table>		Packing Weight (Kg)	Drop Height (cm)	0 ~ 45.4	122	45.4 ~ 90.8	76	90.8 ~ 454	61	Over 454	46
		Packing Weight (Kg)	Drop Height (cm)										
		0 ~ 45.4	122										
		45.4 ~ 90.8	76										
		90.8 ~ 454	61										
Over 454	46												
Drop Direction : ※1 corner / 3 edges / 6 sides each 1time													

#### ◎Result Evaluation Criteria :

Under the display quality test conditions with normal operations with normal operation state. Do not change these conditions as such changes may affect practical display function. (Normal operation state)

Temperature : +20~30°C

Humidity : 50~70%

Atmospheric pressure : 86~106Kpa

## 5. PRECAUTION RELATING PRODUCT HANDLING

### 5.1 SAFETY

- 5.1.1 If the LCD panel breaks, be careful not to get the liquid crystal to touch your skin.
- 5.1.2 If the liquid crystal touches your skin or clothes, please wash it off immediately by using soap and water.

### 5.2 HANDLING

- 5.2.1 Avoid any strong mechanical shock which can break the glass.
- 5.2.2 Avoid static electricity which can damage the CMOS LSI—When working with the module, be sure to ground your body and any electrical equipment you may be using.
- 5.2.3 Do not remove the panel or frame from the module.
- 5.2.4 The polarizing plate of the display is very fragile. So, please handle it very carefully, do not touch, push or rub the exposed polarizing with anything harder than an HB pencil lead (glass, tweezers, etc.)
- 5.2.5 Do not wipe the polarizing plate with a dry cloth, as it may easily scratch the surface of plate.
- 5.2.6 Do not touch the display area with bare hands, this will stain the display area.
- 5.2.7 Do not use ketonics solvent & aromatic solvent. Use with a soft cloth soaked with a cleaning naphtha solvent.
- 5.2.8 To control temperature and time of soldering is  $320 \pm 10^{\circ}\text{C}$  and 3-5 sec.
- 5.2.9 To avoid liquid (include organic solvent) stained on LCM
- 5.2.10 Caution!( LCM products with Capacitive Touch Panel)  
Strong EMI-sources such as switch-mode power supplies (SMPS) can lead to touch malfunction (e.g. ghost-touches).  
Therefore, the touch needs to be thoroughly tested inside the target application.
- 5.2.11 CAUTION: Continuously displaying same static image will result in high possibility of image sticking/image burn-in effect due to TFT panel characteristic.

### 5.3 STORAGE

- 5.3.1 Store the panel or module in a dark place where the temperature is  $25^{\circ}\text{C} \pm 5^{\circ}\text{C}$  and the humidity is below 65% RH.
- 5.3.2 Do not place the module near organics solvents or corrosive gases.
- 5.3.3 Do not crush, shake, or jolt the module.

### 5.4 TERMS OF WARRANTY

- 5.4.1 Applicable warrant period The period is within thirteen months since the date of shipping out under normal using and storage conditions.
- 5.4.2 Unaccepted responsibility  
This product has been manufactured to your company's specification as a part for use in your company's general electronic products. It is guaranteed to perform according to delivery specifications. For any other use apart from general electronic equipment, we cannot take responsibility if the product is used in nuclear power control equipment, aerospace equipment, fire and security systems or any other applications in which there is a direct risk to human life and where extremely high levels of reliability are required.

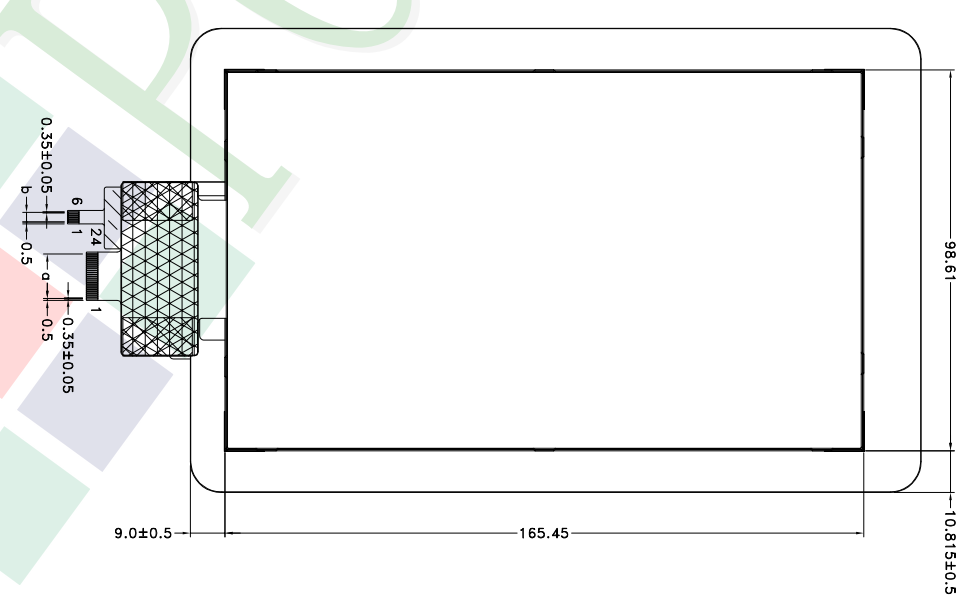
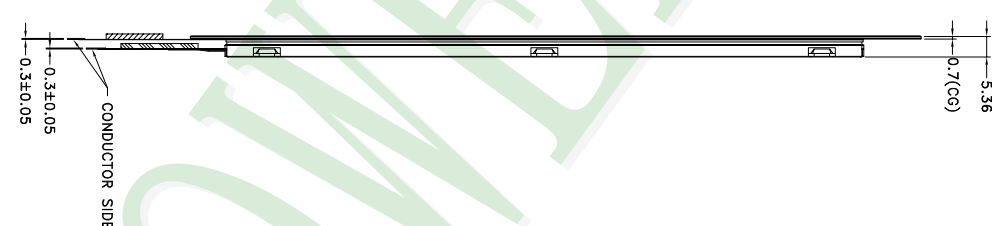
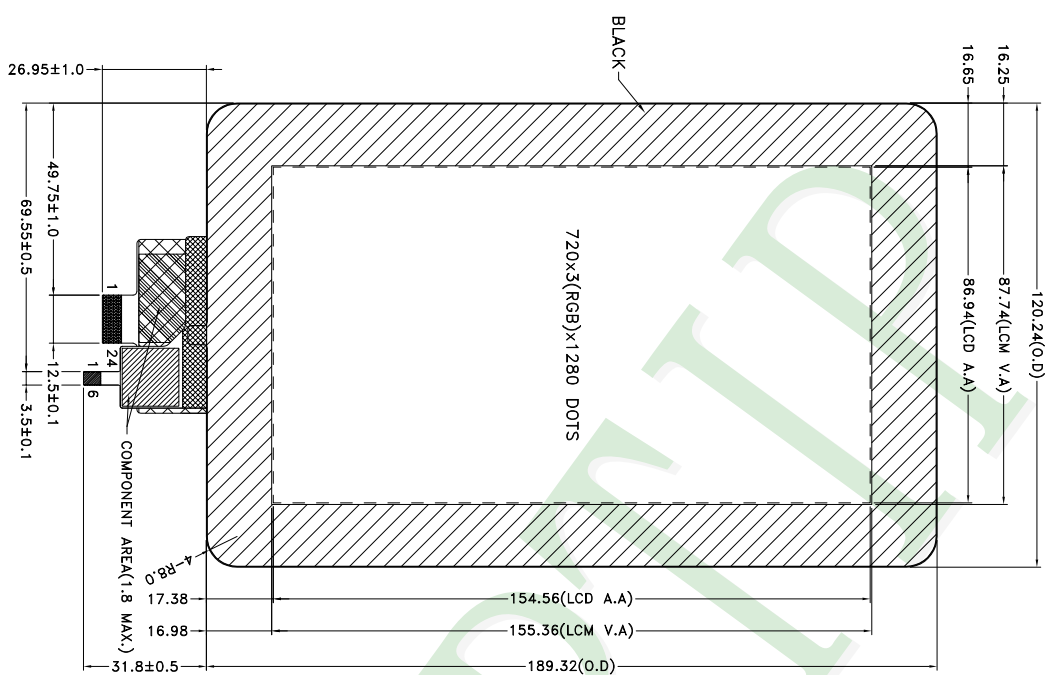

NOTES:  
 1.LCD TYPE: TFT LCD  
 2.LCD DISPLAY: Normally Black  
 3.The tolerance unless classified  $\pm 0.3mm$   
 4.I/P suggested connector: "Cvlux" CF31061DGR2-05-NH OR EQUIVALENT  
 5.I/FT suggested connector: "CHYAO SHUINN" JS-1191DR1-24 OR EQUIVALENT  
 6.a:P0.5X23=11.5±0.05  
 7.b:P0.5X5=2.5±0.05

007				
006				
005				
004				
003				
002				
001	NEW DRAWING	Stone	2021/05/10	
REV		REVISER	DATE	

PART NO:	PH720128T005ZBC
DRAWING NAME:	LMD-PH720128T005ZBC
TITLE:	LCD MODULE DRAWING



久正光電股份有限公司  
 POWER TIP TECHNOLOGY CORPORATION

Design	Stone				
Check	Oliver	Unit	MM	Material	
Approve	Oliver	Scale	1:1	Thickness	
		Page	1/1	Quantity	
				Length (mm)	1 ~ 4
				Taberance (mm)	4 ~ 16
					16 ~ 63
					63 ~ 250
					250 ~ 1000
				Precision Level	



1. 包裝材料規格表 (Packaging Material) : (per carton)

No.	Item	Model	Dimensions (mm)	1Pcs Weight	Quantity	Total Weight
1	成品 (LCM)	PH720128T005ZBC	120.24 X 189.32	0.17	28	4.76
2	氣泡袋(1)Bubble Bag	BAG200160BRABA	200 X 160	0.0096	28	0.2688
3	A6隔板(2)A6 Partition	BX33800012BZBA	338 X 125 X 3	0.038	16	0.608
4	B6隔板(3)B6 Partition	BX29800012BZBA	298 X 125 X 3	0.023	4	0.092
5	海綿墊(4)Foam Rubber Cushion	OTFOAM00005ABA	330 X 290 X 10	0.025	4	0.1
6	舒美墊(5)EPE	OTFOAMT0006ABA	218 X 125 X 20	0.012	4	0.048
7	C4內盒(6)Product Box	BX36031014AABA	360 X 310 X 142	0.406	2	0.812
8	外紙箱(7)Carton	BX39432432CCBA	394 X 324 X 321	0.884	1	0.884
9						

2. 一整箱總重量 (Total LCD Weight in carton) : 7.58 Kg±10%

3. 單箱數量規格表 (Packaging Specifications and Quantity) :

(1)Quantity Of Spacer : A6隔板 X 8 , B6隔板 X 2  
 (2)Total LCM quantity in carton : quantity per box 14 x no of boxes 2 = 28

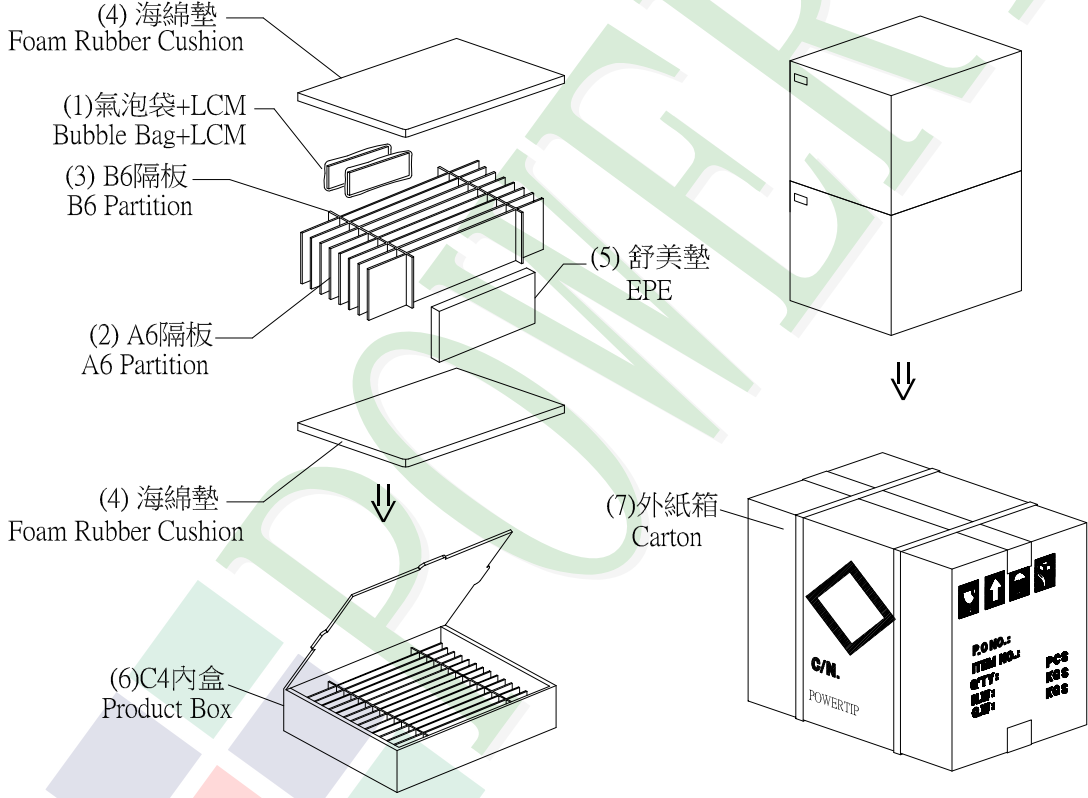

特 記 事 項 (REMARK)

4. 每個間隔放2片模組，前後間隔不放置模組。(如示意圖)  
 4. 2 LCM are placed on every other slot of the divider.  
 Note: First and last slot should be empty.  
 (See remarks 5 on packaging specifications)

5. 放置格示意圖:  
 5. Each divider is placed inside a product Box

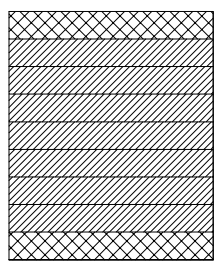

▨ 模組(LCM) X 2pcs.  
 ⊠ 舒美墊(EPE)