

PROTECTION PRODUCTS - MicroClamp™

Description

The μ Clamp™ series of TVS arrays are designed to protect sensitive electronics from damage or latch-up due to ESD. It is designed to replace multilayer varistors (MLVs) in portable applications such as cell phones, notebook computers, and other portable electronics. It features large cross-sectional area junctions for conducting high transient currents. They offer desirable characteristics for board level protection including fast response time, low operating and clamping voltage, and no device degradation.

The μ Clamp™0511T is in a 2-pin, RoHS/WEEE compliant, SLP1006P2T package. It measures 1.0 x 0.6 mm with a nominal height of only 0.4mm. The leads are spaced at a pitch of 0.65mm and are finished with lead-free NiPdAu. Each device will protect one line operating at 5 volts. It gives the designer the flexibility to protect single lines in applications where arrays are not practical. They may be used to meet the ESD immunity requirements of IEC 61000-4-2, Level 4 (± 15 kV air, ± 8 kV contact discharge). The combination of small size and high ESD surge capability makes them ideal for use in portable applications such as cellular phones, digital cameras, and MP3 players.

Features

- ◆ Transient protection for data lines to **IEC 61000-4-2 (ESD) ± 15 kV (air), ± 8 kV (contact)**
IEC 61000-4-4 (EFT) 40A (tp = 5/50ns)
Cable Discharge Event (CDE)
- ◆ Ultra-small package (1.0 x 0.6 x 0.4mm)
- ◆ Protects one data or power line
- ◆ Low reverse current: 3nA typical (VR=3.3V)
- ◆ Working voltage: - 5V / +5V
- ◆ Low capacitance: 4pF typical
- ◆ Solid-state silicon-avalanche technology

Mechanical Characteristics

- ◆ SLP1006P2T package
- ◆ RoHS/WEEE Compliant
- ◆ Nominal Dimensions: 1.0 x 0.6 x 0.4 mm
- ◆ Lead Finish: NiPdAu
- ◆ Molding compound flammability rating: UL 94V-0
- ◆ Marking : Marking code, cathode band
- ◆ Packaging : Tape and Reel

Applications

- ◆ Cellular Handsets & Accessories
- ◆ Keypads, Side Keys, USB 2.0, LCD Displays
- ◆ Notebooks & Desktop Computers
- ◆ Portable Instrumentation
- ◆ Digital Cameras
- ◆ Peripherals
- ◆ MP3 Players

Dimensions

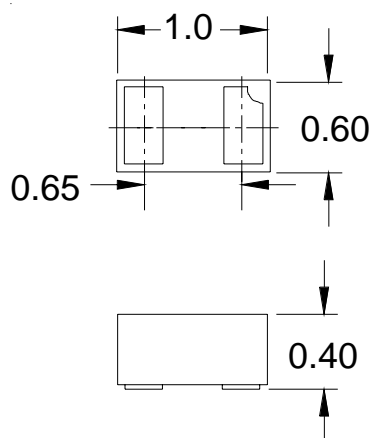

Nominal Dimensions (mm)

Schematic & PIN Configuration

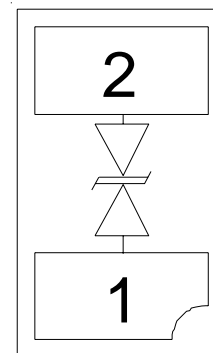

SLP1006P2T (Bottom View)

PROTECTION PRODUCTS

Absolute Maximum Rating

Rating	Symbol	Value	Units
ESD per IEC 61000-4-2 (Air) ESD per IEC 61000-4-2 (Contact)	V_{ESD}	+/- 15 +/- 8	kV
Operating Temperature	T_J	-55 to +125	°C
Storage Temperature	T_{STG}	-55 to +150	°C

Electrical Characteristics (T=25°C)

Parameter	Symbol	Conditions	Minimum	Typical	Maximum	Units
Reverse Stand-Off Voltage	V_{RWM}	Pin 1 to 2 or 2 to 1			5	V
Reverse Breakdown Voltage	V_{BR}	$I_t = 1mA$ Pin 1 to 2 or 2 to 1	6	8.2	9.5	V
Reverse Leakage Current	I_R	$V_{RWM} = 3.3V, T=25^\circ C$ Pin 1 to 2 or 2 to 1		3	50	nA
Clamping Voltage	V_C	$I_{PP} = 2A, t_p = 8/20\mu s$ Pin 1 to 2 or 2 to 1			15	V
Junction Capacitance	C_J	$V_R = 0V, f = 1MHz$		4	7	pF

Non-Repetitive Peak Pulse Power vs. Pulse Time

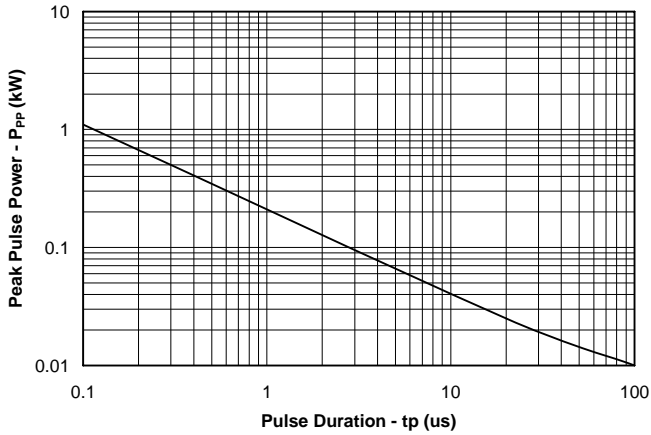

Clamping Voltage vs. Peak Pulse Current

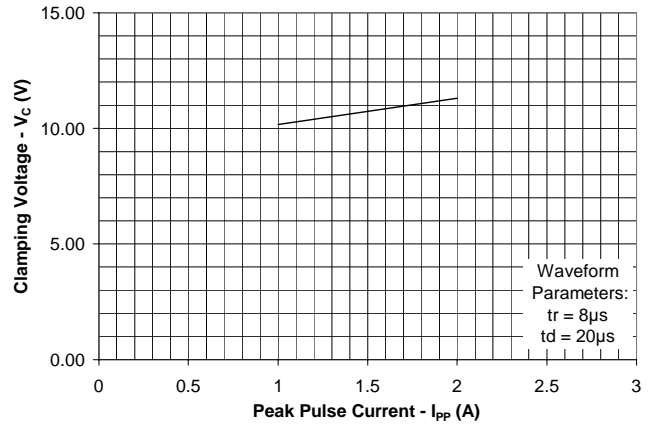

Normalized Junction Capacitance vs. Reverse Voltage

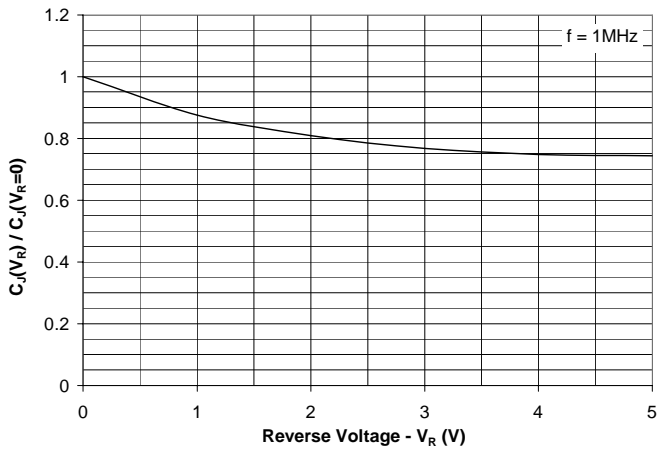

Typical Insertion Loss (S21)

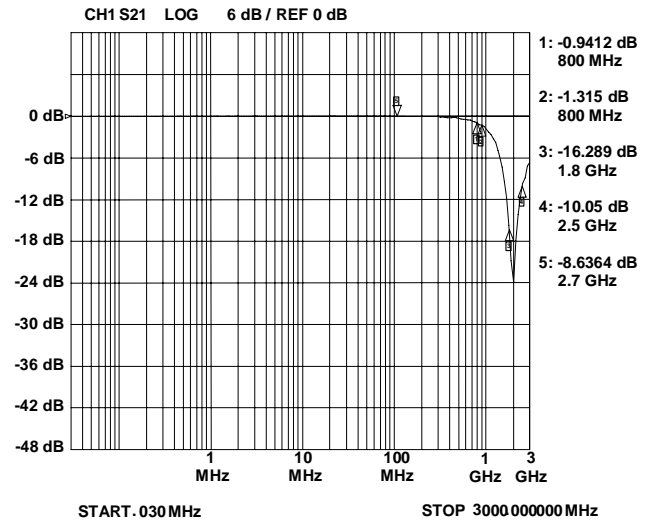

ESD Clamping (Pin 1 to 2 and 2 to 1)
(8kV Contact per IEC 61000-4-2)

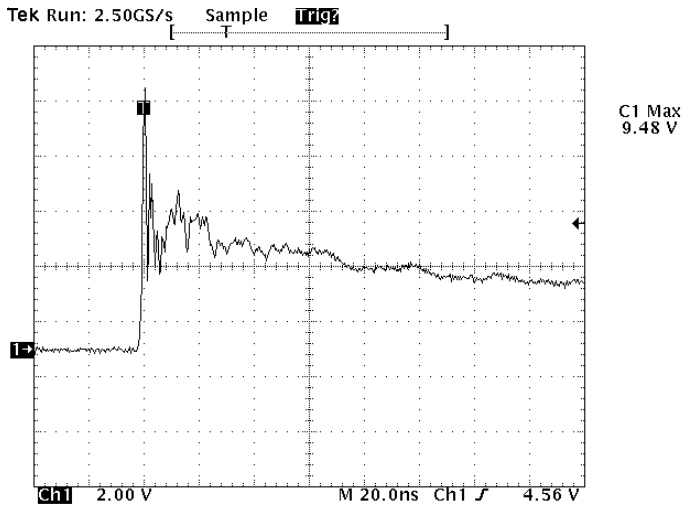

ESD Clamping (Pin 1 to 2 and 2 to 1)
(-8kV Contact per IEC 61000-4-2)

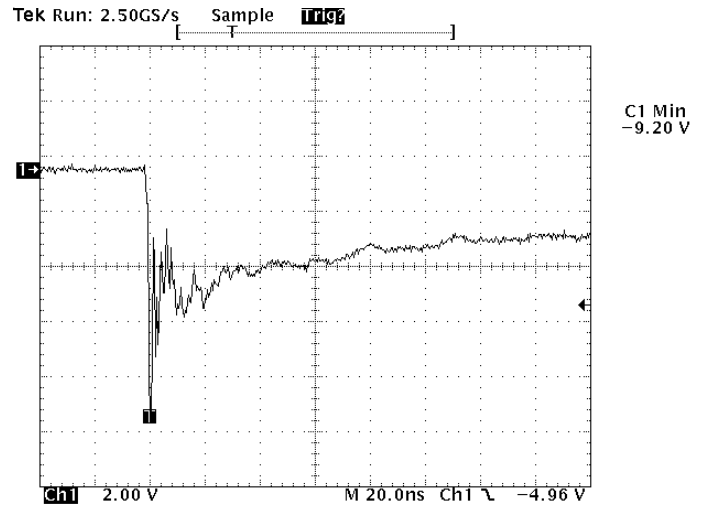

Note: Data is taken with a 10x attenuator

Note: Data is taken with a 10x attenuator

PROTECTION PRODUCTS

Applications Information

Device Connection Options

These TVS diodes are designed to protect one data, I/O, or power supply line. The device is bidirectional and may be used on lines where the signal polarity can go above and below ground.

Circuit Board Layout Recommendations for Suppression of ESD.

Good circuit board layout is critical for the suppression of ESD induced transients. The following guidelines are recommended:

- Place the TVS near the input terminals or connectors to restrict transient coupling.
- Minimize the path length between the TVS and the protected line.
- Minimize all conductive loops including power and ground loops.
- The ESD transient return path to ground should be kept as short as possible.
- Never run critical signals near board edges.
- Use ground planes whenever possible.

Circuit Diagram

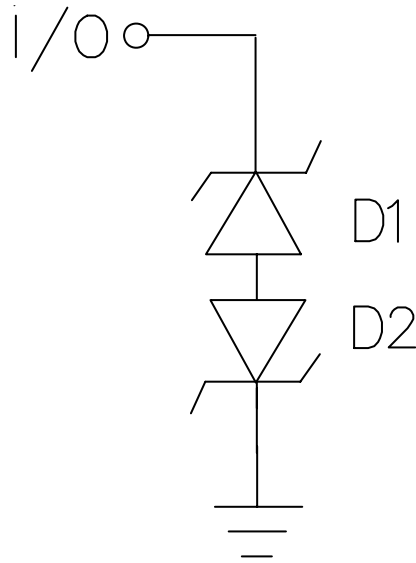

uClamp0511T Spice Model

uClamp0511T Spice Parameters			
Parameter	Unit	D1 (TVS)	D2 (TVS)
IS	Amp	2.05E-15	2.05E-15
BV	Volt	7	7
VJ	Volt	0.8	0.8
RS	Ohm	0.83	0.83
IBV	Amp	1E-3	1E-3
CJO	Farad	3E-12	3E-12
TT	sec	2.541E-9	2.541E-9
M	--	0.25	0.25
N	--	1.1	1.1
EG	eV	1.11	1.11

PROTECTION PRODUCTS

Outline Drawing - SLP1006P2T

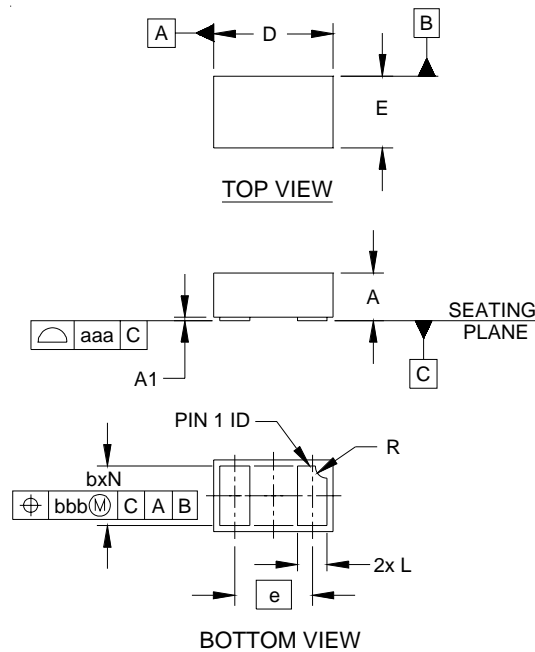

DIM	DIMENSIONS					
	INCHES			MILLIMETERS		
	MIN	NOM	MAX	MIN	NOM	MAX
A	.015	.016	.017	0.37	0.40	0.43
A1	.000	.001	.002	0.00	0.03	0.05
b	.018	.020	.022	0.45	0.50	0.55
D	.035	.039	.043	0.90	1.00	1.10
E	.020	.024	.028	0.50	0.60	0.70
e	.026 BSC			0.65 BSC		
L	.008	.010	.012	0.20	0.25	0.30
R	.002	.004	.006	0.05	0.10	0.15
N	2			2		
aaa	.003			0.08		
bbb	.004			0.10		

- NOTES:
1. CONTROLLING DIMENSIONS ARE IN MILLIMETERS (ANGLES IN DEGREES).

Land Pattern - SLP1006P2T

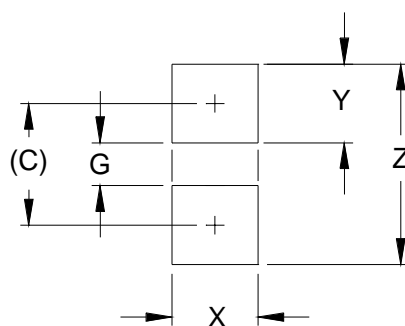

DIM	DIMENSIONS	
	INCHES	MILLIMETERS
C	(.033)	(0.85)
G	.012	0.30
X	.024	0.60
Y	.022	0.55
Z	.055	1.40

- NOTES:
1. CONTROLLING DIMENSIONS ARE IN MILLIMETERS (ANGLES IN DEGREES).
2. THIS LAND PATTERN IS FOR REFERENCE PURPOSES ONLY. CONSULT YOUR MANUFACTURING GROUP TO ENSURE YOUR COMPANY'S MANUFACTURING GUIDELINES ARE MET.

PROTECTION PRODUCTS

Marking Code

PIN 1 ID

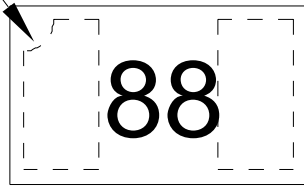

Ordering Information

Part Number	Working Voltage	Qty per Reel	Reel Size
uClamp0511T.TCT	5V	3,000	7 Inch

Notes:

1) This is a lead-free, RoHS/WEEE compliant product
MicroClamp, uClamp and μ Clamp are marks of Semtech Corporation

Notes:

1) Device is electrically symmetrical

Tape and Reel Specification

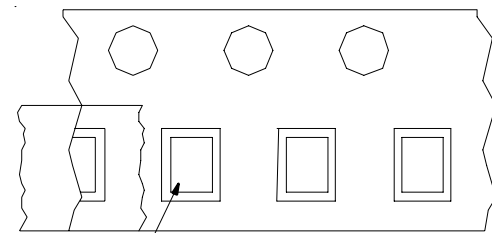
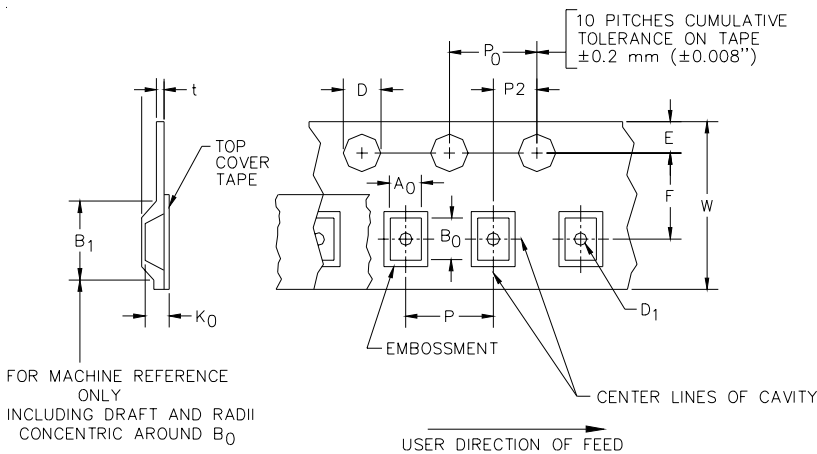

Pin 1 Location

User Direction of feed

Device Orientation in Tape

A0	B0	K0
0.69 +/-0.10 mm	1.19 +/-0.10 mm	0.66 +/-0.10 mm

Tape Width	B, (Max)	D	D1	E	F	P	P0	P2	T	W
8 mm	4.2 mm (.165)	1.5 + 0.1 mm - 0.0 mm (0.59 +.005 - .000)	0.4 mm ±0.25 (.031)	1.750±.10 mm (.069±.004)	3.5±0.05 mm (.138±.002)	4.0±0.10 mm (.157±.004)	4.0±0.1 mm (.157±.004)	2.0±0.05 mm (.079±.002)	0.254±0.02 mm (.016)	8.0 mm + 0.3 mm - 0.1 mm (.312±.012)

Contact Information for Semtech International AG

Taiwan Branch	Tel: 886-2-2748-3380 Fax: 886-2-2748-3390	Semtech Switzerland GmbH Japan Branch	Tel: 81-3-6408-0950 Fax: 81-3-6408-0951
Korea Branch	Tel: 82-2-527-4377 Fax: 82-2-527-4376	Semtech Limited (U.K.)	Tel: 44-1794-527-600 Fax: 44-1794-527-601
Shanghai Office	Tel: 86-21-6391-0830 Fax: 86-21-6391-0831	Semtech France SARL	Tel: 33-(0)169-28-22-00 Fax: 33-(0)169-28-12-98
Semtech International AG is a wholly-owned subsidiary of Semtech Corporation, which has its headquarters in the U.S.A.		Semtech Germany GmbH	Tel: 49-(0)8161-140-123 Fax: 49-(0)8161-140-124