

チップ積層セラミックコンデンサ

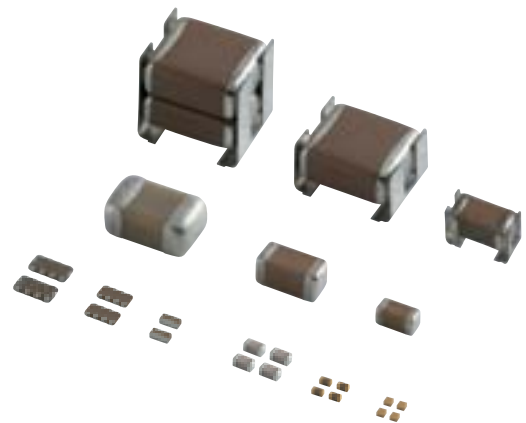
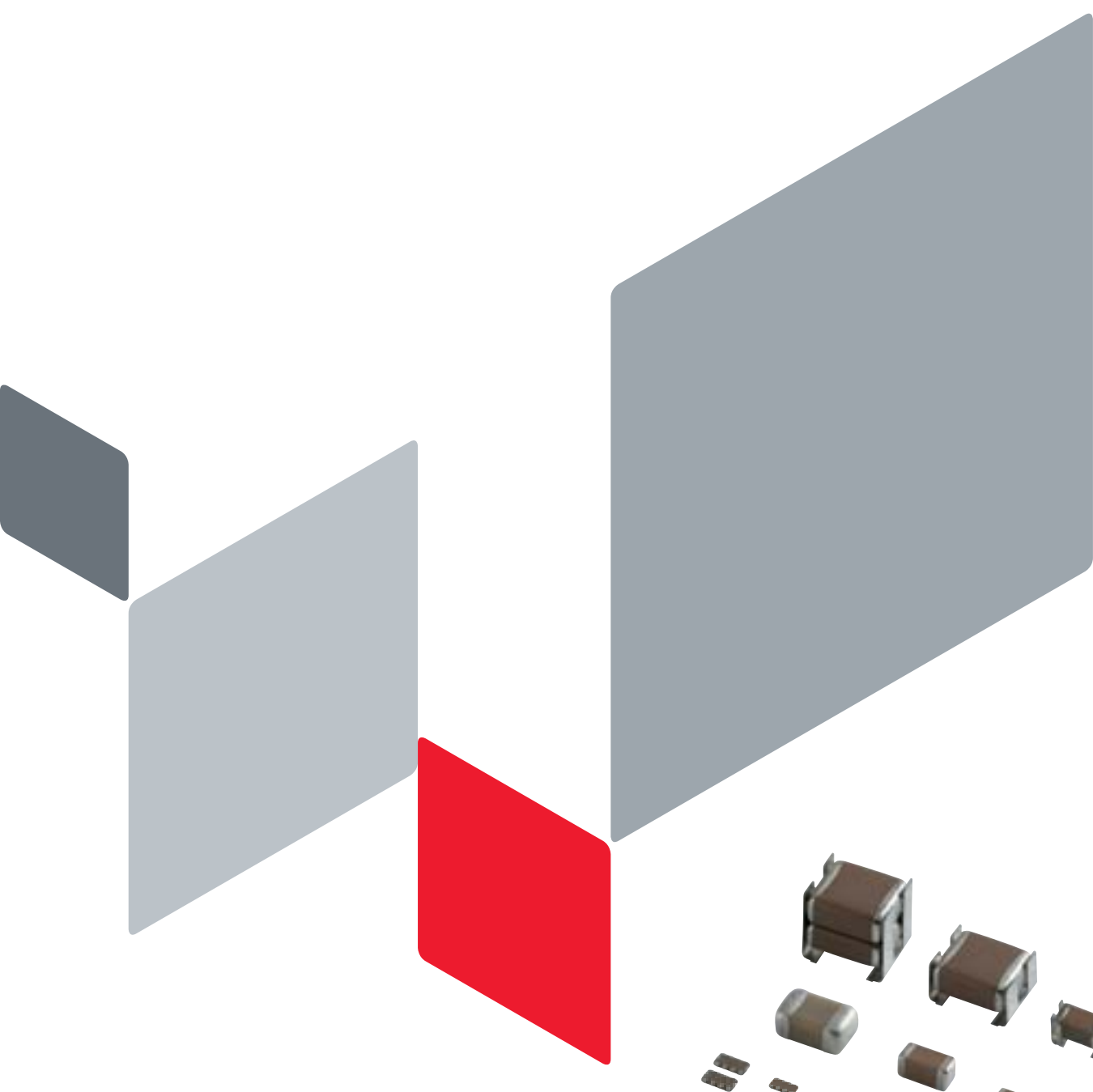

△お願い ・製品によっては、お守りいただかないと発煙、発火等にいたる可能性のある定格や△注意（保管・使用環境、定格上の注意、実装上の注意、取扱上の注意）を記載しておりますので、必ずご覧下さい。
・当カタログには、代表的な仕様しか記載しておりませんので、ご注文にあたっては詳細な仕様が記載されている納入仕様書の内容をご確認いただくか承認図の取交しをお願いします。

当カタログのマーク説明

超小型 LxW寸法：0.6x0.3mm以下の製品

High Q 高周波向け低損失
セラミック材料、電極材料を工夫することでVHF、UHF、マイクロ波以上の周波数帯での低損失を実現しています。

低ESL 低インダクタンス
高周波側でのコンデンサの持つ寄生インダクタンス成分(ESL)が小さくなるよう設計されたコンデンサです。

鳴き対策 鳴き対策に適した製品・低歪品
セラミックコンデンサを用いた場合に生じるコンデンサの鳴きに対して、材料、構造を工夫することで鳴きを抑制した製品です。

たわみクラック たわみクラック対策品
基板たわみ時のクラックによるショートモードでの故障をできるだけ回避するよう設計されたコンデンサです。

はんだクラック はんだクラック抑制品
チップに金属端子およびリードを接続したコンデンサです。金属端子およびリードがはんだの膨張収縮のストレスを緩和することで、はんだクラックを抑制します。

Derating 電圧・温度ディレーティング推奨品
使用回路上で継続的にコンデンサに印加される電圧が、コンデンサの定格電圧よりも軽減(ディレーティング)して使用される場合に適しています。
当品番は、耐久性試験での試験条件を、最高使用温度において、定格電圧x100%で保証しております。
下図に推奨する電圧・温度軽減(ディレーティング)条件内でご使用いただくことで、通常品と同等の信頼性保証レベルを確保することができます。

・使用電圧、温度の軽減(ディレーティング)推奨条件

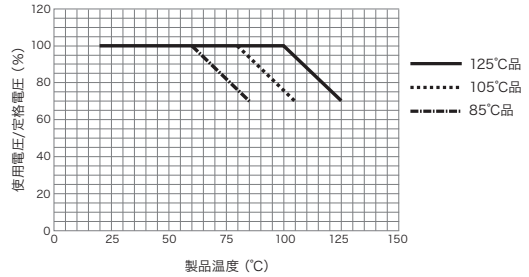

欧州RoHS指令 対応について

- ・当カタログに記載の製品は、全て欧州RoHS指令に対応した製品です。
- ・欧州RoHS指令とは、欧州の「電気電子機器中の特定の危険物質の使用制限に関する指令(2011/65/EU)」およびその修正指令を指します。
- ・当社の欧州RoHS指令対応の詳細については、当社Webサイト「ムラタの欧州RoHS対応について」(<http://www.murata.co.jp/info/rohs.html>)よりご確認ください。

Contents

記載内容は2014年8月現在のものです。

品番の読み方	p2	
セレクションガイド	p5	
静電容量表	p6	
静電容量表		
一般用 GRMシリーズ	p17	別冊 p1-p16
高周波用High Q品 1005 (in mm) サイズ以下		
GJMシリーズ	p87	p7
ボンディング対応上下電極品 GMAシリーズ		
	p109	p8
ボンディング/AuSnはんだ対応品 GMDシリーズ		
	p111	p9
高周波用High Q品 1608 (in mm) サイズ以上		
GQMシリーズ	p114	p10
樹脂外部電極品 GRJシリーズ		
	p123	p11
高実効容量・高リップル耐性品 GR3シリーズ		
	p125	p12
金属端子付き 一般用 KRMシリーズ		
	p127	p13
金属端子付き 高実効容量・高リップル耐性品 KR3シリーズ		
	p130	p14
8端子型低ESL品 LLAシリーズ		
	p133	p14
LW逆転型低ESL品 LLLシリーズ		
	p135	p15
10端子型低ESL品 LLMシリーズ		
	p137	p15
ESR制御型低ESL品 LLRシリーズ		
	p139	p15
△注意/使用上の注意		
	p141	
公規格認定一覧		
	p163	
Webサイトのご案内 SimSurfing		
	p165	
製品情報		
	p166	

カタログに記載のない品番については、
 ムラタホームページ (<http://www.murata.co.jp/>) をご確認ください。

●品番の読み方

一般用 チップ積層セラミックコンデンサ

(品番例)

GR	M	18	8	B1	1H	102	K	A01	D
①	②	③	④	⑤	⑥	⑦	⑧	⑨	⑩

①識別記号 ②シリーズ

識別記号	コード	シリーズ
GJ	M	高周波用HiQ品 1005 (in mm) サイズ以下
	A	ボンディング対応上下電極品
GM	D	ボンディング/AuSnはんだ対応品
	M	高周波用HiQ品 1608 (in mm) サイズ以上
GR	3	高実効容量・高リップル耐性品
	J	樹脂外部電極品
	M	一般用
KR	3	金属端子付き 高実効容量・高リップル耐性品
	M	金属端子品
LL	A	8端子型低ESL品
	L	LW逆転型低ESL品
	M	10端子型低ESL品
	R	ESR制御型低ESL品

③チップ寸法 (L×W)

コード	寸法 (L×W)
02	0.4×0.2mm
03	0.6×0.3mm
05	0.5×0.5mm
08	0.8×0.8mm
0D	0.38×0.38mm
15	1.0×0.5mm
18	1.6×0.8mm
1U	0.6×1.0mm
21	2.0×1.25mm
22	2.8×2.8mm
31	3.2×1.6mm
32	3.2×2.5mm
42	4.5×2.0mm
43	4.5×3.2mm
55	5.7×5.0mm

④高さ寸法 (T) (KR□を除く)

コード	寸法 (T)
2	0.2mm
3	0.3mm
4	0.4mm
5	0.5mm
6	0.6mm
7	0.7mm
8	0.8mm
9	0.85mm
A	1.0mm
B	1.25mm
C	1.6mm
D	2.0mm
E	2.5mm
M	1.15mm
Q	1.5mm
S	2.8mm
X	個別規格によります。

④高さ寸法 (T) (KR□のみ)

コード	寸法 (T)
E	1.8mm
F	1.9mm
K	2.7mm
L	2.8mm
Q	3.7mm
T	4.8mm
W	6.4mm

次ページに続く

(品番例)

GR	M	18	8	B1	1H	102	K	A01	D
①	②	③	④	⑤	⑥	⑦	⑧	⑨	⑩

☐ 前ページより続く

⑤ 温度特性

温度特性記号			温度特性			使用温度範囲	各温度における静電容量変化率 (%)					
コード	公規格記号		基準温度	温度範囲	静電容量変化率 または温度係数		-55℃		*3		-10℃	
	最高値	最低値					最高値	最低値	最高値	最低値		
1X	SL	JIS	20℃	20~85℃	+350~-1000ppm/℃	-55~125℃	-	-	-	-	-	-
2C	CH	JIS	20℃	20~125℃	0±60ppm/℃	-55~125℃	0.82	-0.45	0.49	-0.27	0.33	-0.18
3C	CJ	JIS	20℃	20~125℃	0±120ppm/℃	-55~125℃	1.37	-0.9	0.82	-0.54	0.55	-0.36
3U	UJ	JIS	20℃	20~85℃	-750±120ppm/℃	-25~85℃	-	-	4.94	2.84	3.29	1.89
4C	CK	JIS	20℃	20~125℃	0±250ppm/℃	-55~125℃	2.56	-1.88	1.54	-1.13	1.02	-0.75
5C	C0G	EIA	25℃	25~125℃	0±30ppm/℃	-55~125℃	0.58	-0.24	0.4	-0.17	0.25	-0.11
7U	U2J	EIA	25℃	25~125℃*2	-750±120ppm/℃	-55~125℃	8.78	5.04	6.04	3.47	3.84	2.21
B1	B *1	JIS	20℃	-25~85℃	±10%	-25~85℃	-	-	-	-	-	-
B3	B	JIS	20℃	-25~85℃	±10%	-25~85℃	-	-	-	-	-	-
C7	X7S	EIA	25℃	-55~125℃	±22%	-55~125℃	-	-	-	-	-	-
C8	X6S	EIA	25℃	-55~105℃	±22%	-55~105℃	-	-	-	-	-	-
D7	X7T	EIA	25℃	-55~125℃	+22%、-33%	-55~125℃	-	-	-	-	-	-
D8	X6T	EIA	25℃	-55~105℃	+22%、-33%	-55~105℃	-	-	-	-	-	-
E7	X7U	EIA	25℃	-55~125℃	+22%、-56%	-55~125℃	-	-	-	-	-	-
R1	R *1	JIS	20℃	-55~125℃	±15%	-55~125℃	-	-	-	-	-	-
R6	X5R	EIA	25℃	-55~85℃	±15%	-55~85℃	-	-	-	-	-	-
R7	X7R	EIA	25℃	-55~125℃	±15%	-55~125℃	-	-	-	-	-	-

*1 1/2定格電圧印加時保証あり

*2 定格電圧 100Vdc以下：25~85℃

*3 -25℃ (基準温度20℃の場合) / -30℃ (基準温度25℃の場合)

⑥ 定格電圧

コード	定格電圧
0E	DC2.5V
0G	DC4V
0J	DC6.3V
1A	DC10V
1C	DC16V
1E	DC25V
1H	DC50V
1J	DC63V
1K	DC80V
2A	DC100V
2D	DC200V
2E	DC250V
2W	DC450V
2H	DC500V
2J	DC630V
3A	DC1kV
3D	DC2kV
3F	DC3.15kV
YA	DC35V

⑦ 静電容量

ピコファラド(pF)を単位とし、3文字で表します。最初の2数字は有効数字を表し、第3数字はこれに続くゼロの数となります。ただし、小数点がある場合は小数点を英大文字「R」で表し、この場合の数字は全て有効数字となります。3桁内に「R」以外のアルファベットを含む場合は個別規格によります。

(例)

コード	静電容量
R50	0.50pF
1R0	1.0pF
100	10pF
103	10000pF

⑧ 静電容量許容差

コード	静電容量許容差
B	±0.1pF
C	±0.25pF
D	±0.5pF (10pF未満)
	±0.5% (10pF以上)
F	±1%
G	±2%
J	±5%
K	±10%
M	±20%
W	±0.05pF

次ページに続く ☐

(品番例)

GR M 18 8 B1 1H 102 K A01 D
 ① ② ③ ④ ⑤ ⑥ ⑦ ⑧ ⑨ ⑩

前ページより続く

⑨ 個別仕様 (LLRを除く)

3桁の英数字で表します。

⑩ 等価直列抵抗 (LLRのみ)

コード	等価直列抵抗
E01	100mΩ
E03	220mΩ
E05	470mΩ
E07	1000mΩ

⑩ 包装仕様コード

コード	包装仕様
L	φ180mm エンボステープ
D/E/W	φ180mm 紙テープ
K	φ330mm エンボステープ
J/F	φ330mm 紙テープ
B	バラ包装
T	バラトレイ詰め

表に記載のない品番コードがございましたらお問い合わせください。

チップ積層セラミックコンデンサ セレクションガイド

	シリーズ	0603以下の 超小型	低損失・HIQ	低ESL	フェールセーフ	たわみクラック対策	はんだクラック抑制	鳴き対策・低歪	ボンディング対応	用途限定品	安全規格認定品
一般用	GRM <small>page p17</small>										
	GA2										
	GA3										
	GJM <small>p87</small>										
	GJ4										
	GJ8										
	GMA <small>p109</small>										
	GMD <small>p111</small>										
	GQM <small>p114</small>										
	GRJ <small>p123</small>										
	GR3 <small>p125</small>										
	GR4										
	GR7										
	KRM <small>p127</small>										
	KR3 <small>p130</small>										
	LLA <small>p133</small>										
	LLL <small>p135</small>										
	LLM <small>p137</small>										
	LLR <small>p139</small>										
	ZRA										
ZRB											
自動車用 (Cat. No. C03)	GCM										
	GCD										
	GCE										
	GCG										
	GCJ										
	GC3										
	KCM										
	KC3										

静電容量表

静電容量表の見方

L×W寸法 (mm)	0.4×0.2		0.6×0.3		1.0×0.5	
T寸法 最大値 (mm)	0.22		0.33		0.55	
定格電圧 (Vdc)	25		25		50	
静電容量/温度特性	CΔ	C0G	CΔ	C0G	CΔ	C0G
0.10pF					p101	p104
0.20pF	p88	p91	p94	p97	p101	p104
1.0pF	p88	p91	p94	p98	p101	p105
2.0pF	p88	p91	p95	p98	p101	p105
3.0pF	p88	p91	p95	p98	p102	p105

サイズ・定格電圧・温度特性の順に
絞り込みができます。

品番表のページを記載しております。
該当の品番は品番表をご確認ください。

温度特性一覧表

表内は温度特性記号で配色されています。
各記号の意味は下記の表をご参照ください。

JIS:	CK	CJ	CH	SL	UJ	R	B		
EIA:	C0G	U2J	X7R	X7S	X7T	X7U	X6S	X6T	X5R

温度特性記号	温度特性				使用温度範囲	各温度における静電容量変化率 (%)					
	公規格記号	基準温度	温度範囲	静電容量変化率 または温度係数		-55°C		*2		-10°C	
						最高値	最低値	最高値	最低値	最高値	最低値
CK	JIS	20°C	20~125°C	0±250ppm/°C	-55~125°C	2.56	-1.88	1.54	-1.13	1.02	-0.75
CJ	JIS	20°C	20~125°C	0±120ppm/°C	-55~125°C	1.37	-0.9	0.82	-0.54	0.55	-0.36
CH	JIS	20°C	20~125°C	0±60ppm/°C	-55~125°C	0.82	-0.45	0.49	-0.27	0.33	-0.18
C0G	EIA	25°C	25~125°C	0±30ppm/°C	-55~125°C	0.58	-0.24	0.4	-0.17	0.25	-0.11
SL	JIS	20°C	20~85°C	+350~-1000ppm/°C	-55~125°C	-	-	-	-	-	-
UJ	JIS	20°C	20~85°C	-750±120ppm/°C	-25~85°C	-	-	4.94	2.84	3.29	1.89
U2J	EIA	25°C	25~125°C*1	-750±120ppm/°C	-55~125°C	8.78	5.04	6.04	3.47	3.84	2.21
R	JIS	20°C	-55~125°C	±15%	-55~125°C	-	-	-	-	-	-
X7R	EIA	25°C	-55~125°C	±15%	-55~125°C	-	-	-	-	-	-
X7S	EIA	25°C	-55~125°C	±22%	-55~125°C	-	-	-	-	-	-
X7T	EIA	25°C	-55~125°C	+22%、-33%	-55~125°C	-	-	-	-	-	-
X7U	EIA	25°C	-55~125°C	+22%、-56%	-55~125°C	-	-	-	-	-	-
X6S	EIA	25°C	-55~105°C	±22%	-55~105°C	-	-	-	-	-	-
X6T	EIA	25°C	-55~105°C	+22%、-33%	-55~105°C	-	-	-	-	-	-
B	JIS	20°C	-25~85°C	±10%	-25~85°C	-	-	-	-	-	-
X5R	EIA	25°C	-55~85°C	±15%	-55~85°C	-	-	-	-	-	-

*1 定格電圧100Vdc以下：25~85°C

*2 -25°C (基準温度20°Cの場合) / -30°C (基準温度25°Cの場合)

△お願い：製品によっては、お守りいただかないと発煙、発火等にいたる可能性のある定格や△注意（保管・使用環境、定格上の注意、実装上の注意、取扱上の注意）を記載しておりますので、必ずご覧下さい。
 ・当カタログには、代表的な仕様しか記載しておりませんので、ご注文にあたっては詳細な仕様が記載されている納入仕様書の内容をご確認いただくか承認図の取交しをお願いします。

静電容量表

p00 表内の各番号は、ページ下に印字されているページ番号を表します。

(→ ■GRMシリーズ 温度補償用)

p00 ← 品番表ページ JIS: **CK** **CJ** **CH** **SL** **UJ** EIA: **C0G** **U2J**

L×W寸法 (mm) T寸法 最大値 (mm)	1.6×0.8												2.0×1.25												
	0.9						0.7						0.95						1.0						
	50		10		100		50		50		10		250		200		50								
定格電圧 (Vdc)	UJ	U2J	SL	UJ	U2J	CH	CoG	CH	CoG	SL	UJ	U2J	CH	CoG	SL	UJ	U2J	CoG	U2J	CoG	U2J	SL	UJ		
静電容量/温度特性																									
0.10pF																									
0.20pF																									
0.50pF																									
1.0pF																									
2.0pF																									
3.0pF																									
4.0pF																									
5.0pF																									
6.0pF																									
7.0pF																									
8.0pF																									
9.0pF																									
10pF																					p68			p69	
10.5pF																									
11pF																									
12pF																									
12.5pF																									
13pF																									
14pF																									
15pF																									
16pF																									
17pF																									
18pF																									
19pF																									
20pF																									
21pF																									
22pF																									
24pF																									
27pF																									
30pF																									
33pF																									
36pF																									
39pF																									
43pF																									
47pF																									
51pF																									
56pF																									
62pF																									
68pF																									
75pF																									
82pF																									
91pF																									
94pF																									
96pF																									
100pF																									
120pF																									
150pF																									
180pF																									
220pF																									
270pF																									
330pF																									
390pF																									
470pF																									
560pF																									
680pF																									
820pF																									
1000pF																									
1200pF																									
1500pF																									
1800pF																									
2200pF																									
2700pF																									
3300pF																									
3900pF																									
4700pF																									
5600pF																									
6800pF																									
8200pF																									
10000pF																									
12000pF																									
15000pF																									
18000pF																									
22000pF																									
27000pF																									
33000pF																									
39000pF																									
47000pF																									
56000pF																									
68000pF																									
82000pF																									
0.10μF																									
0.12μF																									



△お願い：製品によっては、お守りいただかないと発煙、発火等にいたる可能性のある定格や△注意（保管・使用環境、定格上の注意、実装上の注意、取扱上の注意）を記載しておりますので、必ずご覧下さい。
 ・当カタログには、代表的な仕様しか記載しておりませんので、ご注文にあたっては詳細な仕様が記載されている納入仕様書の内容をご確認いただくか承認図の取交しをお願いします。

静電容量表

p00 表内の各番号は、ページ下に印字されているページ番号を表します。

(→ ■GRMシリーズ 温度補償用)

L×W寸法 (mm) T寸法 最大値 (mm) 定格電圧 (Vdc) 静電容量/温度特性	2.0×1.25										3.2×1.6												
	1.0		1.35				1.45				0.95					1.0							
	50		50		10		250		200		100		50			2000	1000	1.0			500	250	
U2J	CH	COG	SL	UJ	U2J	SL	UJ	U2J	U2J	CH	COG	CH	COG	SL	UJ	U2J	U2J	COG	U2J	COG	U2J	U2J	
0.10pF																							
0.20pF																							
0.50pF																							
1.0pF																							
2.0pF																							
3.0pF																							
4.0pF																							
5.0pF																							
6.0pF																							
7.0pF																							
8.0pF																							
9.0pF																							
10pF																							
10.5pF																						p70	p71
11pF																							
12pF																							
12.5pF																						p70	p71
13pF																							
14pF																							
15pF																							
16pF																							
17pF																							
18pF																							
19pF																							
20pF																							
21pF																							
22pF																							
24pF																							
27pF																							
30pF																							
33pF																							
36pF																							
39pF																							
43pF																							
47pF																							
51pF																							
56pF																							
62pF																							
68pF																							
75pF																							
82pF																							
91pF																							
94pF																							
96pF																							
100pF																							
120pF																							
150pF																							
180pF																							
220pF																							
270pF																							
330pF																							
390pF																							
470pF																							
560pF																							
680pF																							
820pF																							
1000pF																							
1200pF																							
1500pF																							
1800pF																							
2200pF																							
2700pF																							
3300pF																							
3900pF																							
4700pF																							
5600pF																							
6800pF																							
8200pF																							
10000pF																							
12000pF																							
15000pF																							
18000pF																							
22000pF																							
27000pF																							
33000pF																							
39000pF																							
47000pF																							
56000pF																							
68000pF																							
82000pF																							
0.10μF																							
0.12μF																							



△お願い：製品によっては、お守りいただかないと発煙、発火等にいたる可能性のある定格や△注意（保管・使用環境、定格上の注意、実装上の注意、取扱上の注意）を記載しておりますので、必ずご覧下さい。
 ・当カタログには、代表的な仕様しか記載しておりませんので、ご注文にあたっては詳細な仕様が記載されている納入仕様書の内容をご確認いただくか承認図の取交しをお願いします。

静電容量表

p00 表内の各番号は、ページ下に印字されているページ番号を表します。

(→ ■GRMシリーズ 温度補償用)

p00 ← 品番表ページ JIS: **CK** **CJ** **CH** **SL** **UJ** EIA: **C0G** **U2J**

L×W寸法 (mm) T寸法 最大値 (mm)	3.2×1.6															3.2×2.5												
	1.0		1.25						1.8							1.0												
	200	1000	630		500		250		200		50			1000	630	500	250	50		25	16		2000	630	500			
定格電圧 (Vdc)	U2J	U2J	C0G	U2J	C0G	U2J	U2J	U2J	CH	C0G	SL	UJ	U2J	U2J	U2J	U2J	U2J	CH	C0G	CH	C0G	CH	C0G	U2J	U2J	U2J		
静電容量/温度特性	U2J	U2J	C0G	U2J	C0G	U2J	U2J	U2J	CH	C0G	SL	UJ	U2J	U2J	U2J	U2J	U2J	CH	C0G	CH	C0G	CH	C0G	U2J	U2J	U2J		
0.10pF																												
0.20pF																												
0.50pF																												
1.0pF																												
2.0pF																												
3.0pF																												
4.0pF																												
5.0pF																												
6.0pF																												
7.0pF																												
8.0pF																												
9.0pF																												
10pF																												
10.5pF																												
11pF																												
12pF																												
12.5pF																												
13pF																												
14pF																												
15pF																												
16pF																												
17pF																												
18pF																												
19pF																												
20pF																												
21pF																												
22pF																												
24pF																												
27pF																												
30pF																												
33pF																												
36pF																												
39pF																												
43pF																												
47pF																												
51pF																												
56pF																												
62pF																												
68pF																												
75pF																												
82pF																												p72
91pF																												
94pF																												
96pF																												
100pF																												p72
120pF																												p72
150pF																												p72
180pF																												p72
220pF																												
270pF																												
330pF																												
390pF		p71																										
470pF		p71																										
560pF		p71																										
680pF		p71	p71			p71																						
820pF			p71			p71									p71													
1000pF			p71			p71									p71													
1200pF																												
1500pF																												p72
1800pF																												p72
2200pF																												p72
2700pF		p71				p71																						
3300pF		p71				p71																						
3900pF		p71																										
4700pF		p71																										
5600pF		p71																										
6800pF																												
8200pF																												
10000pF																												
12000pF																												
15000pF																												
18000pF																												
22000pF																												
27000pF																												
33000pF																												
39000pF																												
47000pF																												
56000pF																												
68000pF																												
82000pF																												
0.10μF																												
0.12μF																												



△お願い：製品によっては、お守りいただかないと発煙、発火等にいたる可能性のある定格や△注意（保管・使用環境、定格上の注意、実装上の注意、取扱上の注意）を記載しておりますので、必ずご覧下さい。
 ・当カタログには、代表的な仕様しか記載しておりませんので、ご注文にあたっては詳細な仕様が記載されている納入仕様書の内容をご確認いただくか承認図の取交しをお願いします。

静電容量表

p00 表内の各番号は、ページ下に印字されているページ番号を表します。

(→ ■GRMシリーズ 温度補償用)

p00 ← 品番表ページ JIS: **CK** **CJ** **CH** **SL** **UJ** EIA: **C0G** **U2J**

L×W寸法 (mm) 寸法 最大値 (mm)	3.2×2.5												4.5×2.0		4.5×3.2						5.7×5.0								
	1.25				1.5				2.0				1.0		1.5			2.0			1.5			2.0					
定格電圧 (Vdc)	2000	1000	630	500	1000	630	500	250	1000	630	500	250	3150	1000	630	500	1000	630	500	1000	630	500	1000	630	500	1000	630	500	
静電容量/温度特性	U2J	U2J	U2J	U2J	U2J	U2J	U2J	U2J	U2J	U2J	U2J	U2J	C0G	U2J	U2J	U2J	U2J	U2J	U2J	U2J	U2J	U2J	U2J	U2J	U2J	U2J	U2J	U2J	U2J
0.10pF																													
0.20pF																													
0.50pF																													
1.0pF																													
2.0pF																													
3.0pF																													
4.0pF																													
5.0pF																													
6.0pF																													
7.0pF																													
8.0pF																													
9.0pF																													
10pF																													
10.5pF																													
11pF																													
12pF																													
12.5pF																													
13pF																													
14pF																													
15pF																													
16pF																													
17pF																													
18pF																													
19pF																													
20pF																													
21pF																													
22pF																													
24pF																													
27pF																													
30pF																													
33pF																													
36pF																													
39pF																													
43pF																													
47pF																													
51pF																													
56pF																													
62pF																													
68pF																													
75pF																													
82pF																													
91pF																													
94pF																													
96pF																													
100pF																													
120pF																													
150pF																													
180pF	p72																												
220pF	p72																												
270pF																													
330pF																													
390pF																													
470pF																													
560pF																													
680pF																													
820pF																													
1000pF																													
1200pF		p72																											
1500pF						p72																							
1800pF																													
2200pF																													
2700pF																													
3300pF																													
3900pF																													
4700pF																													
5600pF																													
6800pF																													
8200pF																													
10000pF																													
12000pF																													
15000pF																													
18000pF																													
22000pF																													
27000pF																													
33000pF																													
39000pF																													
47000pF																													
56000pF																													
68000pF																													
82000pF																													
0.10μF																													
0.12μF																													

△お願い：製品によっては、お守りいただかないと発煙、発火等にいたる可能性のある定格や△注意（保管・使用環境、定格上の注意、実装上の注意、取扱上の注意）を記載しておりますので、必ずご覧下さい。
 ・当カタログには、代表的な仕様しか記載しておりませんので、ご注文にあたっては詳細な仕様が記載されている納入仕様書の内容をご確認いただくか承認図の取交しをお願いします。

静電容量表

p00 表内の各番号は、ページ下に印字されているページ番号を表します。

■GRMシリーズ 高誘電率系

p00 ← 品番表ページ JIS: R B EIA: X7R X7S X7T X7U X6S X6T X5R

L×W寸法 (mm)	0.4×0.2						0.6×0.3										1.0×0.5												
T寸法 最大値 (mm)	0.22						0.33										0.22												
定格電圧 (Vdc)	16	10	6.3	4	2.5		50	35		25		16	10	6.3	4	10	6.3	4											
静電容量/温度特性	X7R	X7R	B, X5R	B, X5R	X6T	X5R	X6T	X7R	B	X5R	R, X7R	X6S	B, X5R	R, X7Δ	X6S	B, X5R	R, X7Δ	B, X5R	R, X7R	X6S	B, X5R	X6S	B, X5R	X6S	B, X5R	X6S	B, X5R	X7T	
100pF	p74	p74	p74	p74				p75	p75		p75																		
150pF	p74	p74	p74	p74				p75	p75		p75																		
220pF	p74	p74	p74	p74				p75	p75		p75																		
330pF	p74	p74	p74	p74				p75	p75		p75																		
470pF	p74	p74	p74	p74				p75	p75		p75																		
680pF		p74	p74	p74				p75	p75		p75																		
820pF		p74																											
1000pF	p74	p74	p74	p74	p74			p75	p75		p75	p75		p75															
1500pF			p74	p74	p74			p75	p75		p75	p75		p75															
2200pF			p74	p74	p74						p75		p75	p75		p75													
3300pF			p74	p74	p74						p75		p75	p75		p75													
4700pF			p74	p74	p74						p75		p75	p75		p75			p76	p76	p76	p76	p76					p76	
6800pF			p74	p74	p74						p75		p75	p75		p75			p76	p76	p76	p76	p76					p76	
10000pF			p74	p74	p74						p75		p75	p75		p75	p76	p76	p76	p76	p76	p76							
15000pF				p74		p74									p75	p76		p76	p76			p76	p76						
22000pF				p74		p74									p76	p76		p76	p76			p76	p76						
33000pF				p74		p75									p76	p76		p76	p76			p76	p76						
47000pF				p74		p75									p76	p76		p76	p76			p76	p76						
68000pF				p74		p75									p76	p76		p76	p76			p76	p76						
0.10μF			p74	p74	p75	p75			p75		p75	p75	p75	p75	p76	p76	p76	p76			p76				p76	p77	p77	p77	p77
0.15μF																													
0.22μF																			p76		p76	p76	p76	p76	p76	p77	p77	p77	p77
0.33μF																													
0.47μF																												p77	p77
0.68μF																													
1.0μF																												p77	
2.2μF																													
4.7μF																													
10μF																													
22μF																													
47μF																													
100μF																													
220μF																													



△お願い：製品によっては、お守りいただかないと発煙、発火等にいたる可能性のある定格や△注意（保管・使用環境、定格上の注意、実装上の注意、取扱上の注意）を記載しておりますので、必ずご覧下さい。
 ・当カタログには、代表的な仕様しか記載しておりませんので、ご注文にあたっては詳細な仕様が記載されている納入仕様書の内容をご確認いただくか承認図の取交しをお願いします。

静電容量表

p00 表内の各番号は、ページ下に印字されているページ番号を表します。

(→ ■GRMシリーズ 高誘電率系)

p00 ← 品番表ページ JIS: R B EIA: X7R X7S X7T X7U X6S X6T X5R

L×W寸法 (mm)	1.0×0.5																									
	0.22			0.3				0.33			0.55															
T寸法 最大値 (mm)	4		2.5	50		25	16		10	10	6.3		4	100	50		35		25		16					
定格電圧 (Vdc)	X6△	X5R	X7T	R, X7R	B	X7R	B	X7R	B	X5R	B, X5R	X6T	X7R	R, X7R	X6S	B, X5R	X6S	X5R	R, X7R	X6S	B, X5R	R, X7R	X6S	B, X5R		
静電容量/温度特性	X6△	X5R	X7T	R, X7R	B	X7R	B	X7R	B	X5R	B, X5R	X6T	X7R	R, X7R	X6S	B, X5R	X6S	X5R	R, X7R	X6S	B, X5R	R, X7R	X6S	B, X5R		
100pF																										
150pF																										
220pF				p77	p77	p77							p77	p77	p78		p78									
330pF				p77	p77	p77							p77	p77	p78		p78									
470pF				p77	p77	p77							p77	p77	p78		p78									
680pF				p77	p77	p77							p77	p77	p78		p78									
820pF																										
1000pF				p77	p77	p77							p77	p77	p78		p78									
1500pF				p77	p77	p77							p77	p77	p78		p78									
2200pF						p77	p77						p77	p77	p78		p78									
3300pF								p77	p77				p77	p77	p78		p78									
4700pF										p77	p77		p77	p77	p78		p78									
6800pF															p78	p78		p78				p78				
10000pF															p78	p78		p78				p78	p78		p78	
15000pF											p77				p78		p78					p78	p78		p78	
22000pF												p77			p78		p78					p78	p78		p78	
33000pF													p77		p78	p78	p78					p78	p78		p78	
47000pF															p78	p78	p78					p78	p78		p78	
68000pF															p78	p78	p78					p78	p78		p78	
0.10μF	p77			p77											p78		p78	p78				p78	p78		p78	
0.15μF																									p79	
0.22μF	p77			p77														p78	p78			p78	p79	p79	p79	
0.33μF																										
0.47μF	p77																		p78			p79		p79	p79	
0.68μF																										
1.0μF	p77	p77											p77	p77	p77	p77	p77					p78	p79		p79	p79
2.2μF																										
4.7μF																										
10μF																										
22μF																										
47μF																										
100μF																										
220μF																										



△お願い：製品によっては、お守りいただかないと発煙、発火等にいたる可能性のある定格や△注意（保管・使用環境、定格上の注意、実装上の注意、取扱上の注意）を記載しておりますので、必ずご覧下さい。
 ・当カタログには、代表的な仕様しか記載しておりませんので、ご注文にあたっては詳細な仕様が記載されている納入仕様書の内容をご確認いただくか承認図の取交しをお願いします。

静電容量表

p00 表内の各番号は、ページ下に印字されているページ番号を表します。

(→ ■GRMシリーズ 高誘電率系)

p00 ← 品番表ページ JIS: R B EIA: X7R X7S X7T X7U X6S X6T X5R

L×W寸法 (mm)	1.0×0.5																1.6×0.8										
	0.55				0.6						0.65		0.7				0.5										
T寸法 最大値 (mm)	10		6.3		4		35		25		16		6.3		4		2.5		25		16		6.3		4		
定格電圧 (Vdc)	X7R	X6S	B, X5R	X7R	X6S	B, X5R	X7R	X5R	X6S	X6S	B, X5R	B, X5R	X6T	X6S	X5R	X6S	X5R	X7S	X6S	X7S	X5R	X5R	B, X5R	B, X5R	X5R	X5R	
静電容量/温度特性	X7R	X6S	B, X5R	X7R	X6S	B, X5R	X7R	X5R	X6S	X6S	B, X5R	B, X5R	X6T	X6S	X5R	X6S	X5R	X7S	X6S	X7S	X5R	X5R	B, X5R	B, X5R	X5R	X5R	
100pF																											
150pF																											
220pF																											
330pF																											
470pF																											
680pF																											
820pF																											
1000pF																											
1500pF																											
2200pF																											
3300pF																											
4700pF																											
6800pF																											
10000pF																											
15000pF																											
22000pF																											
33000pF																											
47000pF																											
68000pF																											
0.10μF																											
0.15μF																											
0.22μF	p79																										
0.33μF																											
0.47μF	p79																										
0.68μF																											
1.0μF		p79																									
2.2μF																											
4.7μF																											
10μF																											
22μF																											
47μF																											
100μF																											
220μF																											



△お願い：製品によっては、お守りいただかないと発煙、発火等にいたる可能性のある定格や△注意（保管・使用環境、定格上の注意、実装上の注意、取扱上の注意）を記載しておりますので、必ずご覧下さい。
 ・当カタログには、代表的な仕様しか記載しておりませんので、ご注文にあたっては詳細な仕様が記載されている納入仕様書の内容をご確認いただくか承認図の取交しをお願いします。

静電容量表

p00 表内の各番号は、ページ下に印字されているページ番号を表します。

(→ ■GRMシリーズ 高誘電率系)

p00 ← 品番表ページ JIS: R B EIA: X7R X7S X7T X7U X6S X6T X5R

L×W寸法 (mm)	1.6×0.8																										
T寸法 最大値 (mm)	0.55					0.9						0.95			1.0												
定格電圧 (Vdc)	16	10	6.3	250	200	100	50	25	16	10	6.3	25	16	10	50	35											
静電容量/温度特性	X5R	X6S	X5R	X7T	X6S	X7R	X7R	X7R	R, X7R	B, X5R	R, X7R	B, X5R	R, X7Δ	X6S	B, X5R	X7Δ	B, X5R	B	X5R	X6S	B, X5R	X7S	B, X5R	X5R	X6S	X5R	
100pF																											
150pF																											
220pF						p80	p80	p80	p80	p80	p80																
330pF						p80	p80	p80	p80	p80	p80																
470pF						p80	p80	p80	p80	p80	p80																
680pF						p80	p80	p80	p80	p80	p80																
820pF																											
1000pF						p80	p80	p80	p80	p80	p80																
1500pF						p80	p80	p80	p80	p80	p80																
2200pF						p80	p80	p80	p80	p80	p80																
3300pF								p80	p80	p80	p80																
4700pF								p80	p80	p80	p80																
6800pF								p80	p80	p80	p80																
10000pF								p80	p80	p80	p81																
15000pF								p80	p80	p80	p81																
22000pF								p80	p80	p80	p81																
33000pF								p80	p80	p80	p81	p81	p81														
47000pF								p80	p80	p80	p81	p81	p81														
68000pF								p80	p80	p80	p81	p81	p81														
0.10μF						p80	p80	p80	p81																		
0.15μF								p80	p81	p81	p81	p81	p81														
0.22μF								p80	p81	p81	p81	p81	p81														
0.33μF													p81	p81													
0.47μF													p81	p81													
0.68μF													p81	p81													
1.0μF													p81	p81													
2.2μF													p81	p81													
4.7μF	p80	p80	p80	p80	p80																						
10μF																											
22μF																											
47μF																											
100μF																											
220μF																											



△お願い：製品によっては、お守りいただかないと発煙、発火等にいたる可能性のある定格や△注意（保管・使用環境、定格上の注意、実装上の注意、取扱上の注意）を記載しておりますので、必ずご覧下さい。
 ・当カタログには、代表的な仕様しか記載しておりませんので、ご注文にあたっては詳細な仕様が記載されている納入仕様書の内容をご確認いただくか承認図の取交しをお願いします。

静電容量表

p00 表内の各番号は、ページ下に印字されているページ番号を表します。

(→ ■GRMシリーズ 高誘電率系)

p00 ← 品番表ページ JIS: R B EIA: X7R X7S X7T X7U X6S X6T X5R

L×W寸法 (mm)	1.6×0.8											2.0×1.25																	
	1.0											0.7	0.95																
T寸法 最大値 (mm)	1.0											0.7	0.95																
定格電圧 (Vdc)	25			16			10			6.3		4		16	100	50		35		25			16			10		6.3	
静電容量/温度特性	X7S	X6S	X5R	X7S	X6S	X7T	X7T	B, X5R	X6S	B, X5R	X6S	X7R	R, X7R	B, X5R	X6S	X5R	R, X7R	X6S	B, X5R	R, X7R	X6S	B, X5R	X7Δ	B, X5R	X6S	B, X5R			
100pF																													
150pF																													
220pF																													
330pF																													
470pF																													
680pF																													
820pF																													
1000pF																													
1500pF																													
2200pF																													
3300pF																													
4700pF																													
6800pF																													
10000pF																													
15000pF																													
22000pF																													
33000pF																													
47000pF																													
68000pF																													
0.10μF																													
0.15μF																													
0.22μF																													
0.33μF																													
0.47μF																													
0.68μF																													
1.0μF																													
2.2μF	p82	p82		p82																									
4.7μF		p82																											
10μF			p82	p82	p82	p82																							
22μF																													
47μF																													
100μF																													
220μF																													



△お願い：製品によっては、お守りいただかないと発煙、発火等にいたる可能性のある定格や△注意（保管・使用環境、定格上の注意、実装上の注意、取扱上の注意）を記載しておりますので、必ずご覧下さい。
 ・当カタログには、代表的な仕様しか記載しておりませんので、ご注文にあたっては詳細な仕様が記載されている納入仕様書の内容をご確認いただくか承認図の取交しをお願いします。

静電容量表

p00 表内の各番号は、ページ下に印字されているページ番号を表します。

(→ ■GRMシリーズ 高誘電率系)

p00 ← 品番表ページ JIS: R B EIA: X7R X7S X7T X7U X6S X6T X5R

L×W寸法 (mm)	2.0×1.25																										
T寸法 最大値 (mm)	1.4												1.45														
定格電圧 (Vdc)	10		6.3		4		250	200	50		35			25			16			10		6.3		4			
静電容量/温度特性	X7R	B	X7R	X6S	X7U	X6S	X7R	X7R	X7S	X6S	X7S	X6S	X5R	X7S	X6S	X5R	X7S	X6S	X5R	X7T	X6S	X5R	X7T	B, X5R	X6S	B, X5R	
100pF																											
150pF																											
220pF																											
330pF																											
470pF																											
680pF																											
820pF																											
1000pF																											
1500pF																											
2200pF																											
3300pF																											
4700pF																											
6800pF																											
10000pF																											
15000pF																											
22000pF																											
33000pF																											
47000pF																											
68000pF																											
0.10μF																											
0.15μF																											
0.22μF																											
0.33μF																											
0.47μF																											
0.68μF																											
1.0μF																											
2.2μF																											
4.7μF	p83																										
10μF	p83																										
22μF		p83																									
47μF																											
100μF																											
220μF																											



△お願い：製品によっては、お守りいただかないと発煙、発火等にいたる可能性のある定格や△注意（保管・使用環境、定格上の注意、実装上の注意、取扱上の注意）を記載しておりますので、必ずご覧下さい。
 ・当カタログには、代表的な仕様しか記載しておりませんので、ご注文にあたっては詳細な仕様が記載されている納入仕様書の内容をご確認いただくか承認図の取交しをお願いします。

静電容量表

p00 表内の各番号は、ページ下に印字されているページ番号を表します。

(→ ■GRMシリーズ 高誘電率系)

p00 ← 品番表ページ JIS: R B EIA: X7R X7S X7T X7U X6S X6T X5R

L×W寸法 (mm)	3.2×1.6																						
T寸法 最大値 (mm)	0.95					1.0		1.25					1.3		1.8								
定格電圧 (Vdc)	35	25	16	10	6.3	630	1000	630	250	200	50	25	100	1000	630	250	200	100	50	25	16		
静電容量/温度特性	X5R	R	B, X5R	B, X5R	X6S	B, X5R	X7R	X7R	X7R	X7R	X7R	B	X5R	X7R	X7R	X7R	X7R	X7R	B, X5R	X7R	B, X5R	X7R	X6S
100pF																							
150pF																							
220pF																							
330pF																							
470pF																							
680pF																							
820pF																							
1000pF																							
1500pF																							
2200pF																							
3300pF																							
4700pF																							
6800pF																							
10000pF																							
15000pF																							
22000pF																							
33000pF																							
47000pF																							
68000pF																							
0.10μF																							
0.15μF																							
0.22μF																							
0.33μF																							
0.47μF																							
0.68μF																							
1.0μF																							
2.2μF																							
4.7μF																							
10μF																							
22μF																							
47μF																							
100μF																							
220μF																							



△お願い：製品によっては、お守りいただかないと発煙、発火等にいたる可能性のある定格や△注意（保管・使用環境、定格上の注意、実装上の注意、取扱上の注意）を記載しておりますので、必ずご覧下さい。
 ・当カタログには、代表的な仕様しか記載しておりませんので、ご注文にあたっては詳細な仕様が記載されている納入仕様書の内容をご確認いただくか承認図の取交しをお願いします。

静電容量表

p00 表内の各番号は、ページ下に印字されているページ番号を表します。

(→ ■GRMシリーズ 高誘電率系)

p00 ← 品番表ページ JIS: R B EIA: X7R X7S X7T X7U X6S X6T X5R

L×W寸法 (mm)	3.2×1.6															3.2×2.5									
	1.8					1.9					1.5				1.8	2.0			2.2						
T寸法 最大値 (mm)	16	10	6.3		4	100	25	16	6.3	4		1000	630	250	200	100	1000	630	250	200	25				
定格電圧 (Vdc)	B, X5R	X7R	B, X5R	X7Δ	X6S	B, X5R	X7U	X6S	X7R	X6S	X7S	X6T	X5R	X7U	X6T	X5R	X7R	X7R	X7R	X7R	X7R	X7R	X7R	X7R	X7R
静電容量/温度特性	B, X5R	X7R	B, X5R	X7Δ	X6S	B, X5R	X7U	X6S	X7R	X6S	X7S	X6T	X5R	X7U	X6T	X5R	X7R	X7R	X7R	X7R	X7R	X7R	X7R	X7R	X7R
100pF																									
150pF																									
220pF																									
330pF																									
470pF																									
680pF																									
820pF																									
1000pF																									
1500pF																									
2200pF																									
3300pF																									
4700pF																									
6800pF																									
10000pF																									
15000pF																									
22000pF																									
33000pF																									
47000pF																									
68000pF																									
0.10μF																									
0.15μF																									
0.22μF																									
0.33μF																									
0.47μF																									
0.68μF																									
1.0μF																									
2.2μF																									
4.7μF																									
10μF																									
22μF																									
47μF																									
100μF																									
220μF																									



△お願い：製品によっては、お守りいただかないと発煙、発火等にいたる可能性のある定格や△注意（保管・使用環境、定格上の注意、実装上の注意、取扱上の注意）を記載しておりますので、必ずご覧下さい。
 ・当カタログには、代表的な仕様しか記載しておりませんので、ご注文にあたっては詳細な仕様が記載されている納入仕様書の内容をご確認いただくか承認図の取交しをお願いします。

静電容量表 p00 表内の各番号は、ページ下に印字されているページ番号を表します。

(→ ■GRMシリーズ 高誘電率系)

p00 ← 品番表ページ JIS: R B EIA: X7R X7S X7T X7U X6S X6T X5R

L×W寸法 (mm)	3.2×2.5											4.5×3.2						5.7×5.0									
T寸法 最大値 (mm)	2.7											1.5			2.0			2.0									
定格電圧 (Vdc)	100	80	63	50		35		25		16		10		6.3		4	630	250	200	1000	630	250	200	1000	630		
静電容量/温度特性	X7R	X7R	X7R	X7R	B, X5R	X7R	B, X5R	X7R	B, X5R	X7R	X6S	B, X5R	X7R	B, X5R	X7△	B, X5R	X7U	X7R	X7R	X7R	X7R	X7R	X7R	X7R	X7R	X7R	
100pF																											
150pF																											
220pF																											
330pF																											
470pF																											
680pF																											
820pF																											
1000pF																											
1500pF																											
2200pF																											
3300pF																											
4700pF																											
6800pF																											
10000pF																											
15000pF																											
22000pF																											
33000pF																											
47000pF																											
68000pF																											
0.10μF																											
0.15μF																											
0.22μF																											
0.33μF																											
0.47μF																											
0.68μF																											
1.0μF																											
2.2μF	p85																										
4.7μF		p85																									
10μF			p85	p85	p85	p85	p85	p85	p85																		
22μF								p85	p85	p85	p85																
47μF											p85	p85	p85	p85	p85	p85											
100μF													p85	p85	p85	p85	p85										
220μF																											



△お願い：製品によっては、お守りいただかないと発煙、発火等にいたる可能性のある定格や△注意（保管・使用環境、定格上の注意、実装上の注意、取扱上の注意）を記載しておりますので、必ずご覧下さい。
 ・当カタログには、代表的な仕様しか記載しておりませんので、ご注文にあたっては詳細な仕様が記載されている納入仕様書の内容をご確認いただくか承認図の取交しをお願いします。

静電容量表

p00 表内の各番号は、ページ下に印字されているページ番号を表します。

(→ ■GRMシリーズ 高誘電率系)

p00 ← 品番表ページ	JIS: R B	EIA: X7R X7S X7T X7U X6S X6T X5R
L×W寸法 (mm)	5.7×5.0	
T寸法 最大値 (mm)	2.0	
定格電圧 (Vdc)	250	200
静電容量/温度特性	X7R	X7R
100pF		
150pF		
220pF		
330pF		
470pF		
680pF		
820pF		
1000pF		
1500pF		
2200pF		
3300pF		
4700pF		
6800pF		
10000pF		
15000pF		
22000pF		
33000pF		
47000pF		
68000pF		
0.10μF		
0.15μF		
0.22μF		
0.33μF	p85	p86
0.47μF	p86	p86
0.68μF	p86	p86
1.0μF	p86	p86
2.2μF		
4.7μF		
10μF		
22μF		
47μF		
100μF		
220μF		

△お願い：製品によっては、お守りいただかないと発煙、発火等にいたる可能性のある定格や△注意（保管・使用環境、定格上の注意、実装上の注意、取扱上の注意）を記載しておりますので、必ずご覧下さい。
 ・当カタログには、代表的な仕様しか記載しておりませんので、ご注文にあたっては詳細な仕様が記載されている納入仕様書の内容をご確認いただくか承認図の取交しをお願いします。

静電容量表

p00 表内の各番号は、ページ下に印字されているページ番号を表します。

■GJMシリーズ 温度補償用

p00 ← 品番表ページ

JIS:

CK

CJ

CH

EIA:

C0G

L×W寸法 (mm)	0.4×0.2		0.6×0.3		1.0×0.5	
T寸法 最大値 (mm)	0.22		0.33		0.55	
定格電圧 (Vdc)	25		25		50	
静電容量/温度特性	CΔ	C0G	CΔ	C0G	CΔ	C0G
0.10pF					p101	p104
0.20pF	p88	p91	p94	p97	p101	p104
1.0pF	p88	p91	p94	p98	p101	p105
2.0pF	p88	p91	p95	p98	p101	p105
3.0pF	p88	p91	p95	p98	p102	p105
4.0pF	p89	p92	p95	p98	p102	p105
5.0pF	p89	p92	p95	p99	p102	p106
6.0pF	p89	p92	p96	p99	p102	p106
7.0pF	p90	p93	p96	p99	p103	p106
8.0pF	p90	p93	p96	p100	p103	p107
9.0pF	p90	p94	p97	p100	p104	p107
10pF	p91	p94	p97	p101	p104	p107
11pF	p91	p94	p97	p101	p104	p107
12pF	p91	p94	p97	p101	p104	p108
13pF	p91	p94	p97	p101	p104	p108
15pF	p91	p94	p97	p101	p104	p108
16pF	p91	p94	p97	p101	p104	p108
18pF	p91	p94	p97	p101	p104	p108
20pF	p91	p94	p97	p101	p104	p108
22pF	p91	p94	p97	p101	p104	p108
24pF			p97	p101	p104	p108
27pF			p97	p101	p104	p108
30pF			p97	p101	p104	p108
33pF			p97	p101	p104	p108
36pF					p104	p108
39pF					p104	p108
43pF					p104	p108
47pF					p104	p108

10pF未満は0.1pF毎の記載を省略させて頂いております。
 詳しくは品番表をご参照ください。

△お願い：製品によっては、お守りいただかないと発煙、発火等にいたる可能性のある定格や△注意（保管・使用環境、定格上の注意、実装上の注意、取扱上の注意）を記載しておりますので、必ずご覧下さい。
 ・当カタログには、代表的な仕様しか記載しておりませんので、ご注文にあたっては詳細な仕様が記載されている納入仕様書の内容をご確認いただくか承認図の取交しをお願いします。

静電容量表

p00 表内の各番号は、ページ下に印字されているページ番号を表します。

■GMAシリーズ 高誘電率系

p00 ← 品番表ページ JIS: R B EIA: X7R X5R

L×W寸法 (mm)	0.38×0.38			0.5×0.5								0.8×0.8							
T寸法 最大値 (mm)	0.35			0.4								0.6							
定格電圧 (Vdc)	10			100	25		10			6.3		100	25		10			6.3	
静電容量/温度特性	R	X7R	B	X7R	X7R	B	R	X7R	B	B	X5R	X7R	X7R	B	R	X7R	B	B	X5R
100pF				p110															
150pF				p110															
220pF				p110															
330pF				p110															
470pF				p110															
680pF				p110															
1000pF	p110	p110	p110	p110															
1500pF	p110	p110	p110		p110	p110						p110							
1800pF	p110	p110	p110																
2200pF					p110	p110						p110							
3300pF					p110	p110						p110							
4700pF					p110	p110						p110							
6800pF							p110	p110	p110			p110							
10000pF	p110	p110					p110	p110	p110				p110	p110					
15000pF							p110	p110	p110				p110	p110					
22000pF							p110	p110	p110				p110	p110					
33000pF															p110	p110	p110		
47000pF															p110	p110	p110		
68000pF															p110	p110	p110		
0.10μF										p110	p110				p110	p110	p110		
0.47μF																		p110	p110

△お願い：製品によっては、お守りいただかないと発煙、発火等にいたる可能性のある定格や△注意（保管・使用環境、定格上の注意、実装上の注意、取扱上の注意）を記載しておりますので、必ずご覧下さい。
 ・当カタログには、代表的な仕様しか記載しておりませんので、ご注文にあたっては詳細な仕様が記載されている納入仕様書の内容をご確認いただくか承認図の取交しをお願いします。

静電容量表

p00 表内の各番号は、ページ下に印字されているページ番号を表します。

■GMDシリーズ 高誘電率系

p00 ← 品番表ページ

JIS:

R

B

EIA:

X7R

X5R

L×W寸法 (mm)	0.6×0.3											1.0×0.5										
T寸法 最大値 (mm)	0.33											0.55										
定格電圧 (Vdc)	25			16			10			6.3		50			25			16			10	
静電容量/温度特性	R	X7R	B	R	X7R	B	R	X7R	B	B	X5R	R	X7R	B	R	X7R	B	R	X7R	B	B	X5R
100pF	p112	p112	p112																			
120pF	p112	p112	p112																			
150pF	p112	p112	p112																			
180pF	p112	p112	p112																			
220pF	p112	p112	p112									p112	p112	p113								
270pF	p112	p112	p112									p112	p113	p113								
330pF	p112	p112	p112									p112	p113	p113								
390pF	p112	p112	p112									p112	p113	p113								
470pF	p112	p112	p112									p112	p113	p113								
560pF	p112	p112	p112									p112	p113	p113								
680pF	p112	p112	p112									p112	p113	p113								
820pF	p112	p112	p112									p112	p113	p113								
1000pF	p112	p112	p112									p112	p113	p113								
1200pF	p112	p112	p112									p112	p113	p113								
1500pF	p112	p112	p112									p112	p113	p113								
1800pF				p112	p112	p112						p112	p113	p113								
2200pF				p112	p112	p112						p112	p113	p113								
2700pF				p112	p112	p112						p112	p113	p113								
3300pF				p112	p112	p112						p112	p113	p113								
3900pF							p112	p112	p112			p112	p113	p113								
4700pF							p112	p112	p112			p112	p113	p113								
5600pF							p112	p112	p112						p113	p113	p113					
6800pF							p112	p112	p112						p113	p113	p113					
8200pF							p112	p112	p112						p113	p113	p113					
10000pF							p112	p112	p112						p113	p113	p113					
12000pF															p113	p113	p113					
15000pF															p113	p113	p113					
18000pF															p113	p113	p113					
22000pF															p113	p113	p113					
27000pF															p113	p113	p113					
33000pF															p113	p113	p113					
39000pF															p113	p113	p113					
47000pF															p113	p113	p113					
56000pF											p112	p112						p113	p113	p113		
68000pF											p112	p112						p113	p113	p113		
82000pF											p112	p112						p113	p113	p113		
0.10μF											p112	p112						p113	p113	p113		
0.12μF																					p113	p113
0.15μF																					p113	p113
0.18μF																					p113	p113
0.22μF																					p113	p113
0.27μF																					p113	p113
0.33μF																					p113	p113
0.39μF																					p113	p113
0.47μF																					p113	p113

静電容量表

p00 表内の各番号は、ページ下に印字されているページ番号を表します。

■GQMシリーズ 温度補償用

p00 ← 品番表ページ JIS: **CK** **CJ** **CH** EIA: **C0G**

L×W寸法 (mm)	1.6×0.8					2.0×1.25					2.8×2.8
T寸法 最大値 (mm)	0.8	0.9				0.95				1.0	1.35
定格電圧 (Vdc)	250	100		50		100		50		250	500
静電容量/温度特性	C0G	CΔ	C0G	CH	C0G	CΔ	C0G	CH	C0G	C0G	C0G
1.0pF	p115	p115	p116			p117	p118			p120	p121
2.0pF	p115	p116	p116			p118	p118			p120	p121
3.0pF	p115	p116	p116			p118	p118			p120	p121
4.0pF	p115	p116	p116			p118	p118			p120	p121
5.0pF	p115	p116	p116			p118	p118			p120	p121
6.0pF	p115	p116	p116			p118	p119			p120	p121
7.0pF	p115			p116	p117	p118	p119			p120	p121
8.0pF	p115			p116	p117	p118	p119			p120	p121
9.0pF	p115			p116	p117	p118	p119			p120	p121
10pF	p115			p116	p117	p118	p119			p120	p121
11pF	p115			p116	p117	p118	p119			p120	p121
12pF	p115			p116	p117	p118	p119			p120	p121
13pF	p115			p116	p117	p118	p119			p120	p121
15pF	p115			p116	p117	p118	p119			p120	p121
16pF	p115			p116	p117	p118	p119			p120	p121
18pF	p115			p117	p117	p118	p119			p120	p121
20pF	p115			p117	p117			p119	p119	p120	p121
22pF	p115			p117	p117			p119	p119	p120	p121
24pF	p115			p117	p117			p119	p119	p120	p121
27pF	p115			p117	p117			p119	p119	p120	p121
30pF	p115			p117	p117			p119	p119	p120	p121
33pF	p115			p117	p117			p119	p119	p120	p121
36pF	p115			p117	p117			p119	p119	p120	p121
39pF	p115			p117	p117			p119	p119	p120	p121
43pF	p115			p117	p117			p119	p119	p120	p121
47pF	p115			p117	p117			p119	p119	p120	p121
51pF				p117	p117			p119	p119	p120	p121
56pF				p117	p117			p119	p119	p120	p121
62pF				p117	p117			p119	p119	p120	p121
68pF				p117	p117			p119	p119	p120	p121
75pF				p117	p117			p119	p119	p120	p122
82pF				p117	p117			p119	p119	p120	p122
91pF				p117	p117			p119	p119	p120	p122
100pF				p117	p117			p119	p119	p121	p122

10pF未満は0.1pF毎の記載を省略させて頂いております。詳しくは品番表をご参照ください。

△お願い：製品によっては、お守りいただかないと発煙、発火等にいたる可能性のある定格や△注意（保管・使用環境、定格上の注意、実装上の注意、取扱上の注意）を記載しておりますので、必ずご覧下さい。
 ・当カタログには、代表的な仕様しか記載しておりませんので、ご注文にあたっては詳細な仕様が記載されている納入仕様書の内容をご確認いただくか承認図の取交しをお願いします。

静電容量表

p00 表内の各番号は、ページ下に印字されているページ番号を表します。

■GRJシリーズ 高誘電率系

p00 ← 品番表ページ EIA: X7R X7S

L×W寸法 (mm)	2.0×1.25		3.2×1.6						3.2×2.5												
	1.0	1.45	1.25			1.8			1.5			2.0			2.3	2.8					
定格電圧 (Vdc)	250	250	1000	630	250	1000	630	250	1000	630	250	1000	630	250	100	50	25	16	10	6.3	
静電容量/温度特性	X7R	X7R	X7R	X7R	X7R	X7R	X7R	X7R	X7R	X7R	X7R	X7R	X7R	X7R	X7R	X7R	X7S	X7R	X7R	X7R	X7R
470pF			p124																		
680pF			p124																		
1000pF	p124		p124	p124																	
1500pF	p124		p124	p124																	
2200pF	p124		p124	p124																	
3300pF	p124		p124	p124																	
4700pF	p124		p124	p124																	
6800pF	p124			p124		p124			p124												
10000pF		p124		p124		p124			p124												
15000pF		p124			p124		p124					p124									
22000pF		p124			p124		p124			p124		p124									
33000pF								p124					p124								
47000pF								p124					p124								
68000pF					p124						p124										
0.10μF								p124						p124							
0.15μF										p124											
0.22μF													p124								
0.33μF																					
0.47μF																					
0.68μF																					
1.0μF																					
2.2μF																p124					
4.7μF																	p124				
10μF																		p124	p124		
22μF																			p124	p124	
47μF																					p124



L×W寸法 (mm)	4.5×3.2					5.7×5.0			
	1.5		2.0			2.0			
定格電圧 (Vdc)	630	250	1000	630	250	1000	630	250	
静電容量/温度特性	X7R	X7R	X7R	X7R	X7R	X7R	X7R	X7R	
33000pF			p124						
47000pF			p124						
68000pF	p124					p124			
0.10μF				p124		p124			
0.15μF		p124					p124		
0.22μF					p124		p124		
0.33μF								p124	
0.47μF								p124	
0.68μF								p124	
1.0μF								p124	

△お願い：製品によっては、お守りいただかないと発煙、発火等にいたる可能性のある定格や△注意（保管・使用環境、定格上の注意、実装上の注意、取扱上の注意）を記載しておりますので、必ずご覧下さい。
 ・当カタログには、代表的な仕様しか記載しておりませんので、ご注文にあたっては詳細な仕様が記載されている納入仕様書の内容をご確認いただくか承認図の取交しをお願いします。

静電容量表

p00 表内の各番号は、ページ下に印字されているページ番号を表します。

■GR3シリーズ 高誘電率系

p00 ← 品番表ページ EIA: X7T

L×W寸法 (mm)	2.0×1.25		3.2×1.6						3.2×2.5					4.5×3.2			5.7×5.0								
T寸法 最大値 (mm)	1.0	1.45	1.0		1.25		1.8		1.5		2.0			1.5		2.0		2.0			2.7				
定格電圧 (Vdc)	250	250	450	250	630	450	250	630	450	250	630	250	630	450	250	250	630	450	250	630	450	250	630	450	250
静電容量/温度特性	X7T	X7T	X7T	X7T	X7T	X7T	X7T	X7T	X7T	X7T	X7T	X7T	X7T	X7T	X7T	X7T	X7T	X7T	X7T	X7T	X7T	X7T	X7T	X7T	X7T
10000pF	p126		p126		p126																				
15000pF	p126		p126				p126																		
22000pF		p126				p126				p126															
33000pF				p126		p126							p126												
47000pF						p126		p126					p126												
68000pF									p126					p126											
0.10μF										p126			p126										p126		
0.15μF														p126								p126			
0.22μF															p126							p126		p126	
0.27μF																								p126	
0.33μF																							p126		
0.47μF																							p126	p126	
0.56μF																									p126
0.68μF																								p126	
1.0μF																									p126

△お願い：製品によっては、お守りいただかないと発煙、発火等にいたる可能性のある定格や△注意（保管・使用環境、定格上の注意、実装上の注意、取扱上の注意）を記載しておりますので、必ずご覧下さい。
 ・当カタログには、代表的な仕様しか記載しておりませんので、ご注文にあたっては詳細な仕様が記載されている納入仕様書の内容をご確認いただくか承認図の取交しをお願いします。

静電容量表

p00 表内の各番号は、ページ下に印字されているページ番号を表します。

■KRMシリーズ 高誘電率系

p00 ← 品番表ページ EIA: X7R X6S X5R

L×W寸法 (mm)	3.5×1.7					3.6×1.7	3.7×1.85	6.1×5.3														
	2.0		2.9			2.9	2.9	3.0						3.9					5.0			
T寸法 最大値 (mm)	25	100	50	35	25	50	100	1000	630	250	100	63	50	35	25	100	63	50	35	25	1000	630
定格電圧 (Vdc)	25	100	50	35	25	50	100	1000	630	250	100	63	50	35	25	100	63	50	35	25	1000	630
静電容量/温度特性	X5R	X7R	X7R	X6S	X6S	X7R	X7R	X7R	X7R	X7R	X7R	X7R	X7R	X7R	X7R	X7R	X7R	X7R	X7R	X7R	X7R	X7R
68000pF								p129														
0.10μF								p129														
0.15μF									p129													p129
0.22μF									p129													p129
0.33μF																						p129
0.47μF																						p129
0.68μF										p129												
1.0μF		p129								p129												
1.5μF																						
2.2μF						p129	p129															
4.7μF			p129									p129	p129	p129								
6.8μF																p129						
10μF	p129			p129	p129								p129	p129			p129					
15μF														p129	p129							
17μF																			p129	p129		
22μF																			p129	p129		
33μF																				p129		
47μF																						
68μF																						



L×W寸法 (mm)	6.1×5.3									
	5.0					6.7				
T寸法 最大値 (mm)	250	100	50	35	25	100	63	50	35	25
定格電圧 (Vdc)	250	100	50	35	25	100	63	50	35	25
静電容量/温度特性	X7R	X7R	X7R	X7R	X7R	X7R	X7R	X7R	X7R	X7R
68000pF										
0.10μF										
0.15μF										
0.22μF										
0.33μF										
0.47μF										
0.68μF										
1.0μF										
1.5μF	p129									
2.2μF	p129									
4.7μF										
6.8μF										
10μF		p129								
15μF						p129				
17μF										
22μF			p129	p129			p129			
33μF				p129	p129			p129		
47μF									p129	p129
68μF										p129

静電容量表

p00 表内の各番号は、ページ下に印字されているページ番号を表します。

■KR3シリーズ 高誘電率系

p00 ← 品番表ページ EIA: X7T

L×W寸法 (mm)	6.1×5.3										
T寸法 最大値 (mm)	3.0			3.9			5.0		6.7		
定格電圧 (Vdc)	630	450	250	630	450	250	450	250	630	450	250
静電容量/温度特性	X7T	X7T	X7T	X7T	X7T	X7T	X7T	X7T	X7T	X7T	X7T
0.10μF	p132										
0.15μF	p132										
0.22μF		p132		p132							
0.27μF				p132							
0.33μF		p132									
0.47μF		p132	p132						p132		
0.56μF					p132				p132		
0.68μF			p132				p132				
1.0μF						p132	p132				
1.2μF										p132	
1.5μF								p132			
2.2μF											p132

■LLAシリーズ 高誘電率系

p00 ← 品番表ページ EIA: X7R X7S

L×W寸法 (mm)	1.6×0.8	2.0×1.25										3.2×1.6							
T寸法 最大値 (mm)	0.55	0.55					0.95					0.55			0.95			1.25	
定格電圧 (Vdc)	4	25	16	10	6.3	4	25	16	10	6.3	4	16	10	6.3	16	10	16	10	
静電容量/温度特性	X7S	X7R	X7R	X7R	X7R	X7S	X7R	X7R	X7R	X7R	X7S	X7R	X7R	X7R	X7R	X7R	X7R	X7R	X7R
10000pF		p134					p134												
22000pF		p134					p134												
47000pF			p134				p134												
0.10μF	p134		p134					p134											
0.22μF	p134			p134				p134				p134							
0.47μF	p134				p134				p134				p134		p134				
1.0μF						p134				p134				p134		p134	p134		
2.2μF	p134										p134			p134					p134
4.7μF						p134													

静電容量表

p00 表内の各番号は、ページ下に印字されているページ番号を表します。

■LLLシリーズ 高誘電率系

p00 ← 品番表ページ EIA: X7R X7S X6S X5R

L×W寸法 (mm)	0.5×1.0				0.6×1.0		0.8×1.6								1.25×2.0															
T寸法 最大値 (mm)	0.35				0.45		0.5				0.55				0.6				0.5				0.7							
定格電圧 (Vdc)	6.3	4			4				25	16	10	4			4	50	25	16	10	4			50	25	16	10	6.3	4	50	25
静電容量/温度特性	X6S	X7S	X6S	X5R	X7R	X7R	X7R	X7S	X7R	X7R	X7R	X7R	X7S	X7R	X7R	X7R	X7R	X7R	X7R	X7R	X7S	X7R	X7R	X7R	X7R	X7R	X7S	X7R	X7R	
2200pF															p136															
4700pF															p136															
10000pF								p136																					p136	
22000pF																													p136	
47000pF																													p136	
0.10μF	p136																												p136	
0.22μF	p136																												p136	
0.47μF		p136																											p136	
1.0μF			p136																										p136	
2.2μF																													p136	
4.3μF																													p136	
4.7μF																													p136	
10μF																													p136	



L×W寸法 (mm)	1.25×2.0				1.6×3.2																	
T寸法 最大値 (mm)	0.7				0.95				0.5				0.8				1.25					
定格電圧 (Vdc)	10	16	10	4	50	25	16	10	50	25	16	10	6.3	50	25	16	10	6.3				
静電容量/温度特性	X7R	X7R	X7R	X7S	X7R	X7R	X7R	X7R	X7R	X7R	X7R	X7R	X7R	X7R	X7R	X7R	X7R	X7R	X5R			
2200pF																						
4700pF																						
10000pF																						
22000pF																						
47000pF																						
0.10μF																						
0.22μF	p136	p136																				
0.47μF			p136																			
1.0μF			p136																			
2.2μF				p136																		
4.3μF																						
4.7μF																						
10μF																						

■LLMシリーズ 高誘電率系

p00 ← 品番表ページ EIA: X7R X7S

L×W寸法 (mm)	2.0×1.25		3.2×1.6		
T寸法 最大値 (mm)	0.55		0.55		
定格電圧 (Vdc)	6.3	4	16	10	6.3
静電容量/温度特性	X7R	X7S	X7R	X7R	X7R
0.10μF					p138
0.22μF	p138				p138
0.47μF	p138				p138
1.0μF		p138			
2.2μF					p138

■LLRシリーズ 高誘電率系

p00 ← 品番表ページ EIA: X7S

L×W寸法 (mm)	0.8×1.6			
T寸法 最大値 (mm)	0.55			
定格電圧 (Vdc)	4			
温度特性	X7S			
静電容量/等価直列抵抗 (mΩ)	100	220	470	1000
1.0μF	p140	p140	p140	p140

コンデンサ検索

性能および試験方法、包装情報、特性データなど製品の詳細については、
 Webサイトのコンデンサ検索ページをご参照ください。
<http://www.murata.co.jp/products/capacitor/>



データシート

製品詳細ページをPDFで出力することができます。

ステータス・特徴アイコン

製品のステータスや特徴を一目でご確認いただけます。
 ⓘをクリックすると、各アイコンの説明が表示されます。

特徴/用途

各シリーズの紹介ページへリンクしています。

詳細スペックシート

下記の内容を掲載しております。

- 定格値
- 性能および試験方法
- 包装情報
- 使用上の注意
 （保管・実装/ランド寸法・洗浄・輸送など）

特性データ

主要製品は下記特性データが取得できます。

- SPICE Netlist (mod形式)
- Sparameter (S2P形式)
- 信頼性試験データ *代表データ

- 形状(寸法)
- 定格値

- 包装コード別の仕様/最小受注単位数
- 質量 (1個・φ180mmリール)

特性データグラフ

主要製品は特性データグラフも掲載しております。

主なデータの種類は下記のとおりです。

- 周波数特性 (ESR, Impedance)
- Sパラ (スミスチャート S11)
- DCバイアス特性
- AC電圧特性
- 静電容量-温度特性
- リプル発熱特性

設計支援ツールSimSurfing

設計支援ツールSimSurfingで他のグラフを表示、数値データをCSVダウンロード、他品番のグラフの重ねがきなどができます。

一般用

GRMシリーズ

最先端技術を導入して小型化、大容量化を志向した当社の主力商品です。

特徴

① 積層構造により、大容量化・小型化を実現。

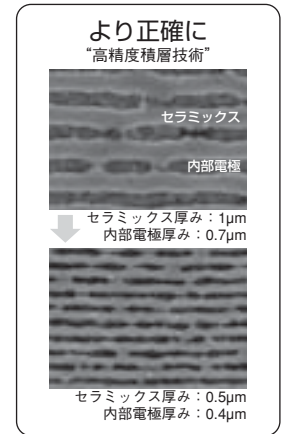
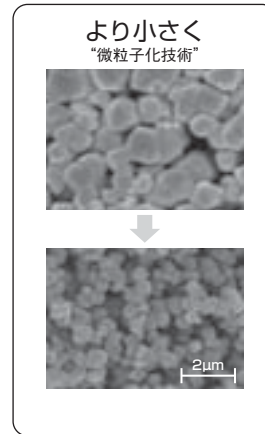
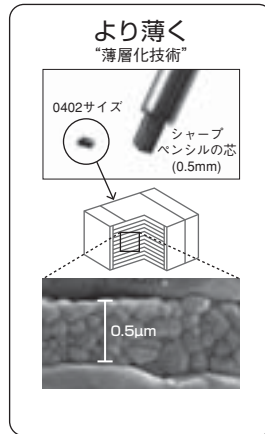
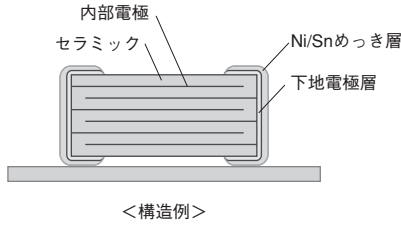

② 外部電極にはSnめっきが施してあり、はんだ付け性に優れています。

③ 信頼性が高く、極性がありません。

	セラミックコンデンサ	タンタルコンデンサ	アルミ電解コンデンサ	導電性高分子コンデンサ
価格	○	○	◎	○
インピーダンス周波数特性	◎	△	△	○
静電容量温度特性	○	◎	○	○
直流破壊電圧	◎	△	△	△
極性	無	有	有	有
パルス応答性	◎	△	△	○
許容リップル電流	◎	△	△	△
信頼性	◎	○	○	○
DCバイアス特性	△	◎	◎	◎

◎：特に優れている ○：優れている △：劣る

主な仕様

サイズ	0.4×0.2mm~5.7×5.0mm
定格電圧	DC2.5V~3.15kV
静電容量	0.1pF~220μF
主な用途	1. 定格電圧100V以下 高誘電率系・・・デカップリング・平滑回路用 温度補償用・・・同調回路・発振回路・高周波フィルタ回路用 2. 定格電圧200V以上 高誘電率系・・・クランプスナバー回路、平滑回路用 温度補償用・・・電源ダンパースナバー

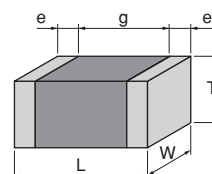

<外形寸法図>

当カタログに掲載している製品は一部です。
 詳しくはWebサイトのコンデンサ検索ページをご参照ください。

GRMシリーズ 温度補償用 品番表

■0.4×0.2mm 超小型

T寸法 最大値	定格 電圧	温度 特性	静電容量	許容差	品番
0.22mm	16Vdc	CK	0.20pF	±0.05pF	GRM0224C1CR20WA02#
				±0.1pF	GRM0224C1CR20BA02#
			0.30pF	±0.05pF	GRM0224C1CR30WA02#
				±0.1pF	GRM0224C1CR30BA02#
			0.40pF	±0.05pF	GRM0224C1CR40WA02#
				±0.1pF	GRM0224C1CR40BA02#
			0.50pF	±0.05pF	GRM0224C1CR50WA02#
				±0.1pF	GRM0224C1CR50BA02#
			0.60pF	±0.05pF	GRM0224C1CR60WA02#
				±0.1pF	GRM0224C1CR60BA02#
			0.70pF	±0.05pF	GRM0224C1CR70WA02#
				±0.1pF	GRM0224C1CR70BA02#
			0.80pF	±0.05pF	GRM0224C1CR80WA02#
				±0.1pF	GRM0224C1CR80BA02#
			0.90pF	±0.05pF	GRM0224C1CR90WA02#
				±0.1pF	GRM0224C1CR90BA02#
			1.0pF	±0.05pF	GRM0224C1C1R0WA02#
				±0.1pF	GRM0224C1C1R0BA02#
				±0.25pF	GRM0224C1C1R0CA02#
			1.1pF	±0.05pF	GRM0224C1C1R1WA02#
				±0.1pF	GRM0224C1C1R1BA02#
				±0.25pF	GRM0224C1C1R1CA02#
			1.2pF	±0.05pF	GRM0224C1C1R2WA02#
				±0.1pF	GRM0224C1C1R2BA02#
		±0.25pF		GRM0224C1C1R2CA02#	
		1.3pF	±0.05pF	GRM0224C1C1R3WA02#	
			±0.1pF	GRM0224C1C1R3BA02#	
			±0.25pF	GRM0224C1C1R3CA02#	
		1.4pF	±0.05pF	GRM0224C1C1R4WA02#	
			±0.1pF	GRM0224C1C1R4BA02#	
			±0.25pF	GRM0224C1C1R4CA02#	
		1.5pF	±0.05pF	GRM0224C1C1R5WA02#	
			±0.1pF	GRM0224C1C1R5BA02#	
			±0.25pF	GRM0224C1C1R5CA02#	
		1.6pF	±0.05pF	GRM0224C1C1R6WA02#	
			±0.1pF	GRM0224C1C1R6BA02#	
			±0.25pF	GRM0224C1C1R6CA02#	
		1.7pF	±0.05pF	GRM0224C1C1R7WA02#	
			±0.1pF	GRM0224C1C1R7BA02#	
			±0.25pF	GRM0224C1C1R7CA02#	
		1.8pF	±0.05pF	GRM0224C1C1R8WA02#	
			±0.1pF	GRM0224C1C1R8BA02#	
			±0.25pF	GRM0224C1C1R8CA02#	
		1.9pF	±0.05pF	GRM0224C1C1R9WA02#	
			±0.1pF	GRM0224C1C1R9BA02#	
			±0.25pF	GRM0224C1C1R9CA02#	
		2.0pF	±0.05pF	GRM0224C1C2R0WA02#	
			±0.1pF	GRM0224C1C2R0BA02#	
±0.25pF	GRM0224C1C2R0CA02#				
±0.05pF	GRM0223C1C2R1WA02#				
±0.1pF	GRM0223C1C2R1BA02#				
±0.25pF	GRM0223C1C2R1CA02#				
CJ	±0.05pF	GRM0223C1C2R1WA02#			
	±0.1pF	GRM0223C1C2R1BA02#			
	±0.25pF	GRM0223C1C2R1CA02#			

T寸法 最大値	定格 電圧	温度 特性	静電容量	許容差	品番
0.22mm	16Vdc	CJ	2.2pF	±0.05pF	GRM0223C1C2R2WA02#
				±0.1pF	GRM0223C1C2R2BA02#
				±0.25pF	GRM0223C1C2R2CA02#
			2.3pF	±0.05pF	GRM0223C1C2R3WA02#
				±0.1pF	GRM0223C1C2R3BA02#
				±0.25pF	GRM0223C1C2R3CA02#
			2.4pF	±0.05pF	GRM0223C1C2R4WA02#
				±0.1pF	GRM0223C1C2R4BA02#
				±0.25pF	GRM0223C1C2R4CA02#
			2.5pF	±0.05pF	GRM0223C1C2R5WA02#
				±0.1pF	GRM0223C1C2R5BA02#
				±0.25pF	GRM0223C1C2R5CA02#
			2.6pF	±0.05pF	GRM0223C1C2R6WA02#
				±0.1pF	GRM0223C1C2R6BA02#
				±0.25pF	GRM0223C1C2R6CA02#
			2.7pF	±0.05pF	GRM0223C1C2R7WA02#
				±0.1pF	GRM0223C1C2R7BA02#
				±0.25pF	GRM0223C1C2R7CA02#
			2.8pF	±0.05pF	GRM0223C1C2R8WA02#
				±0.1pF	GRM0223C1C2R8BA02#
				±0.25pF	GRM0223C1C2R8CA02#
			2.9pF	±0.05pF	GRM0223C1C2R9WA02#
				±0.1pF	GRM0223C1C2R9BA02#
				±0.25pF	GRM0223C1C2R9CA02#
			3.0pF	±0.05pF	GRM0223C1C3R0WA02#
				±0.1pF	GRM0223C1C3R0BA02#
				±0.25pF	GRM0223C1C3R0CA02#
			3.1pF	±0.05pF	GRM0223C1C3R1WA02#
				±0.1pF	GRM0223C1C3R1BA02#
				±0.25pF	GRM0223C1C3R1CA02#
			3.2pF	±0.05pF	GRM0223C1C3R2WA02#
				±0.1pF	GRM0223C1C3R2BA02#
				±0.25pF	GRM0223C1C3R2CA02#
			3.3pF	±0.05pF	GRM0223C1C3R3WA02#
				±0.1pF	GRM0223C1C3R3BA02#
				±0.25pF	GRM0223C1C3R3CA02#
			3.4pF	±0.05pF	GRM0223C1C3R4WA02#
				±0.1pF	GRM0223C1C3R4BA02#
				±0.25pF	GRM0223C1C3R4CA02#
			3.5pF	±0.05pF	GRM0223C1C3R5WA02#
				±0.1pF	GRM0223C1C3R5BA02#
				±0.25pF	GRM0223C1C3R5CA02#
			3.6pF	±0.05pF	GRM0223C1C3R6WA02#
				±0.1pF	GRM0223C1C3R6BA02#
				±0.25pF	GRM0223C1C3R6CA02#
			3.7pF	±0.05pF	GRM0223C1C3R7WA02#
				±0.1pF	GRM0223C1C3R7BA02#
				±0.25pF	GRM0223C1C3R7CA02#
3.8pF	±0.05pF	GRM0223C1C3R8WA02#			
	±0.1pF	GRM0223C1C3R8BA02#			
	±0.25pF	GRM0223C1C3R8CA02#			
3.9pF	±0.05pF	GRM0223C1C3R9WA02#			
	±0.1pF	GRM0223C1C3R9BA02#			
	±0.25pF	GRM0223C1C3R9CA02#			

品番 #には包装仕様コードが入ります。

GRMシリーズ
 GJMシリーズ
 GMAシリーズ
 GMDシリーズ
 GQMシリーズ
 GRJシリーズ
 GR3シリーズ
 KRMシリーズ
 KR3シリーズ
 LLAシリーズ
 LLLシリーズ
 LLMシリーズ
 LLRシリーズ
 △注意/
 使用上の注意

GRMシリーズ 温度補償用 品番表

(→ ■0.4×0.2mm)

T寸法 最大値	定格 電圧	温度 特性	静電容量	許容差	品番
0.22mm	16Vdc	CH	0.20pF	±0.05pF	GRM0222C1CR20WA02#
				±0.1pF	GRM0222C1CR20BA02#
			0.30pF	±0.05pF	GRM0222C1CR30WA02#
				±0.1pF	GRM0222C1CR30BA02#
			0.40pF	±0.05pF	GRM0222C1CR40WA02#
				±0.1pF	GRM0222C1CR40BA02#
			0.50pF	±0.05pF	GRM0222C1CR50WA02#
				±0.1pF	GRM0222C1CR50BA02#
			0.60pF	±0.05pF	GRM0222C1CR60WA02#
				±0.1pF	GRM0222C1CR60BA02#
			0.70pF	±0.05pF	GRM0222C1CR70WA02#
				±0.1pF	GRM0222C1CR70BA02#
			0.80pF	±0.05pF	GRM0222C1CR80WA02#
				±0.1pF	GRM0222C1CR80BA02#
			0.90pF	±0.05pF	GRM0222C1CR90WA02#
				±0.1pF	GRM0222C1CR90BA02#
			1.0pF	±0.05pF	GRM0222C1C1R0WA02#
				±0.1pF	GRM0222C1C1R0BA02#
				±0.25pF	GRM0222C1C1R0CA02#
			1.1pF	±0.05pF	GRM0222C1C1R1WA02#
				±0.1pF	GRM0222C1C1R1BA02#
				±0.25pF	GRM0222C1C1R1CA02#
			1.2pF	±0.05pF	GRM0222C1C1R2WA02#
				±0.1pF	GRM0222C1C1R2BA02#
				±0.25pF	GRM0222C1C1R2CA02#
			1.3pF	±0.05pF	GRM0222C1C1R3WA02#
				±0.1pF	GRM0222C1C1R3BA02#
				±0.25pF	GRM0222C1C1R3CA02#
			1.4pF	±0.05pF	GRM0222C1C1R4WA02#
				±0.1pF	GRM0222C1C1R4BA02#
				±0.25pF	GRM0222C1C1R4CA02#
			1.5pF	±0.05pF	GRM0222C1C1R5WA02#
				±0.1pF	GRM0222C1C1R5BA02#
				±0.25pF	GRM0222C1C1R5CA02#
			1.6pF	±0.05pF	GRM0222C1C1R6WA02#
				±0.1pF	GRM0222C1C1R6BA02#
				±0.25pF	GRM0222C1C1R6CA02#
			1.7pF	±0.05pF	GRM0222C1C1R7WA02#
				±0.1pF	GRM0222C1C1R7BA02#
				±0.25pF	GRM0222C1C1R7CA02#
			1.8pF	±0.05pF	GRM0222C1C1R8WA02#
				±0.1pF	GRM0222C1C1R8BA02#
				±0.25pF	GRM0222C1C1R8CA02#
			1.9pF	±0.05pF	GRM0222C1C1R9WA02#
				±0.1pF	GRM0222C1C1R9BA02#
				±0.25pF	GRM0222C1C1R9CA02#
			2.0pF	±0.05pF	GRM0222C1C2R0WA02#
				±0.1pF	GRM0222C1C2R0BA02#
±0.25pF	GRM0222C1C2R0CA02#				
2.1pF	±0.05pF	GRM0222C1C2R1WA02#			
	±0.1pF	GRM0222C1C2R1BA02#			
	±0.25pF	GRM0222C1C2R1CA02#			
2.2pF	±0.05pF	GRM0222C1C2R2WA02#			
	±0.1pF	GRM0222C1C2R2BA02#			

T寸法 最大値	定格 電圧	温度 特性	静電容量	許容差	品番
0.22mm	16Vdc	CH	2.2pF	±0.25pF	GRM0222C1C2R2CA02#
				±0.05pF	GRM0222C1C2R3WA02#
			2.3pF	±0.05pF	GRM0222C1C2R3BA02#
				±0.25pF	GRM0222C1C2R3CA02#
			2.4pF	±0.05pF	GRM0222C1C2R4WA02#
				±0.1pF	GRM0222C1C2R4BA02#
				±0.25pF	GRM0222C1C2R4CA02#
			2.5pF	±0.05pF	GRM0222C1C2R5WA02#
				±0.1pF	GRM0222C1C2R5BA02#
				±0.25pF	GRM0222C1C2R5CA02#
			2.6pF	±0.05pF	GRM0222C1C2R6WA02#
				±0.1pF	GRM0222C1C2R6BA02#
				±0.25pF	GRM0222C1C2R6CA02#
			2.7pF	±0.05pF	GRM0222C1C2R7WA02#
				±0.1pF	GRM0222C1C2R7BA02#
				±0.25pF	GRM0222C1C2R7CA02#
			2.8pF	±0.05pF	GRM0222C1C2R8WA02#
				±0.1pF	GRM0222C1C2R8BA02#
				±0.25pF	GRM0222C1C2R8CA02#
			2.9pF	±0.05pF	GRM0222C1C2R9WA02#
				±0.1pF	GRM0222C1C2R9BA02#
				±0.25pF	GRM0222C1C2R9CA02#
			3.0pF	±0.05pF	GRM0222C1C3R0WA02#
				±0.1pF	GRM0222C1C3R0BA02#
				±0.25pF	GRM0222C1C3R0CA02#
			3.1pF	±0.05pF	GRM0222C1C3R1WA02#
				±0.1pF	GRM0222C1C3R1BA02#
				±0.25pF	GRM0222C1C3R1CA02#
			3.2pF	±0.05pF	GRM0222C1C3R2WA02#
				±0.1pF	GRM0222C1C3R2BA02#
				±0.25pF	GRM0222C1C3R2CA02#
			3.3pF	±0.05pF	GRM0222C1C3R3WA02#
				±0.1pF	GRM0222C1C3R3BA02#
				±0.25pF	GRM0222C1C3R3CA02#
			3.4pF	±0.05pF	GRM0222C1C3R4WA02#
				±0.1pF	GRM0222C1C3R4BA02#
				±0.25pF	GRM0222C1C3R4CA02#
			3.5pF	±0.05pF	GRM0222C1C3R5WA02#
				±0.1pF	GRM0222C1C3R5BA02#
				±0.25pF	GRM0222C1C3R5CA02#
			3.6pF	±0.05pF	GRM0222C1C3R6WA02#
				±0.1pF	GRM0222C1C3R6BA02#
				±0.25pF	GRM0222C1C3R6CA02#
			3.7pF	±0.05pF	GRM0222C1C3R7WA02#
				±0.1pF	GRM0222C1C3R7BA02#
				±0.25pF	GRM0222C1C3R7CA02#
			3.8pF	±0.05pF	GRM0222C1C3R8WA02#
				±0.1pF	GRM0222C1C3R8BA02#
±0.25pF	GRM0222C1C3R8CA02#				
3.9pF	±0.05pF	GRM0222C1C3R9WA02#			
	±0.1pF	GRM0222C1C3R9BA02#			
	±0.25pF	GRM0222C1C3R9CA02#			
4.0pF	±0.05pF	GRM0222C1C4R0WA02#			
	±0.1pF	GRM0222C1C4R0BA02#			

品番 #には包装仕様コードが入ります。

GRMシリーズ 温度補償用 品番表

(→ ■0.4×0.2mm)

T寸法 最大値	定格 電圧	温度 特性	静電容量	許容差	品番
0.22mm	16Vdc	CH	4.0pF	±0.25pF	GRM0222C1C4R0CA02#
				±0.05pF	GRM0222C1C4R1WA02#
					±0.1pF
			±0.25pF		GRM0222C1C4R1CA02#
			4.2pF	±0.05pF	GRM0222C1C4R2WA02#
				±0.1pF	GRM0222C1C4R2BA02#
				±0.25pF	GRM0222C1C4R2CA02#
			4.3pF	±0.05pF	GRM0222C1C4R3WA02#
				±0.1pF	GRM0222C1C4R3BA02#
				±0.25pF	GRM0222C1C4R3CA02#
			4.4pF	±0.05pF	GRM0222C1C4R4WA02#
				±0.1pF	GRM0222C1C4R4BA02#
				±0.25pF	GRM0222C1C4R4CA02#
			4.5pF	±0.05pF	GRM0222C1C4R5WA02#
				±0.1pF	GRM0222C1C4R5BA02#
				±0.25pF	GRM0222C1C4R5CA02#
			4.6pF	±0.05pF	GRM0222C1C4R6WA02#
				±0.1pF	GRM0222C1C4R6BA02#
				±0.25pF	GRM0222C1C4R6CA02#
			4.7pF	±0.05pF	GRM0222C1C4R7WA02#
				±0.1pF	GRM0222C1C4R7BA02#
				±0.25pF	GRM0222C1C4R7CA02#
			4.8pF	±0.05pF	GRM0222C1C4R8WA02#
				±0.1pF	GRM0222C1C4R8BA02#
				±0.25pF	GRM0222C1C4R8CA02#
			4.9pF	±0.05pF	GRM0222C1C4R9WA02#
				±0.1pF	GRM0222C1C4R9BA02#
				±0.25pF	GRM0222C1C4R9CA02#
			5.0pF	±0.05pF	GRM0222C1C5R0WA02#
				±0.1pF	GRM0222C1C5R0BA02#
				±0.25pF	GRM0222C1C5R0CA02#
			5.1pF	±0.05pF	GRM0222C1C5R1WA02#
				±0.1pF	GRM0222C1C5R1BA02#
				±0.25pF	GRM0222C1C5R1CA02#
				±0.5pF	GRM0222C1C5R1DA02#
			5.2pF	±0.05pF	GRM0222C1C5R2WA02#
				±0.1pF	GRM0222C1C5R2BA02#
				±0.25pF	GRM0222C1C5R2CA02#
				±0.5pF	GRM0222C1C5R2DA02#
			5.3pF	±0.05pF	GRM0222C1C5R3WA02#
				±0.1pF	GRM0222C1C5R3BA02#
				±0.25pF	GRM0222C1C5R3CA02#
				±0.5pF	GRM0222C1C5R3DA02#
			5.4pF	±0.05pF	GRM0222C1C5R4WA02#
				±0.1pF	GRM0222C1C5R4BA02#
				±0.25pF	GRM0222C1C5R4CA02#
				±0.5pF	GRM0222C1C5R4DA02#
			5.5pF	±0.05pF	GRM0222C1C5R5WA02#
±0.1pF	GRM0222C1C5R5BA02#				
±0.25pF	GRM0222C1C5R5CA02#				
±0.5pF	GRM0222C1C5R5DA02#				
5.6pF	±0.05pF	GRM0222C1C5R6WA02#			
	±0.1pF	GRM0222C1C5R6BA02#			
	±0.25pF	GRM0222C1C5R6CA02#			
	±0.5pF	GRM0222C1C5R6DA02#			

T寸法 最大値	定格 電圧	温度 特性	静電容量	許容差	品番
0.22mm	16Vdc	CH	5.6pF	±0.5pF	GRM0222C1C5R6DA02#
				±0.05pF	GRM0222C1C5R7WA02#
					±0.1pF
			±0.25pF		GRM0222C1C5R7CA02#
			5.7pF	±0.5pF	GRM0222C1C5R7DA02#
				±0.05pF	GRM0222C1C5R8WA02#
					±0.1pF
			5.8pF		±0.25pF
				±0.5pF	GRM0222C1C5R8DA02#
				5.9pF	±0.05pF
			±0.1pF		GRM0222C1C5R9BA02#
			±0.25pF		GRM0222C1C5R9CA02#
			6.0pF	±0.5pF	GRM0222C1C5R9DA02#
				±0.05pF	GRM0222C1C6R0WA02#
					±0.1pF
			6.1pF		±0.25pF
				±0.5pF	GRM0222C1C6R0DA02#
				6.2pF	±0.05pF
			±0.1pF		GRM0222C1C6R1BA02#
			±0.25pF		GRM0222C1C6R1CA02#
			6.3pF	±0.5pF	GRM0222C1C6R1DA02#
				±0.05pF	GRM0222C1C6R2WA02#
					±0.1pF
			6.4pF		±0.25pF
				±0.5pF	GRM0222C1C6R2DA02#
				6.5pF	±0.05pF
			±0.1pF		GRM0222C1C6R3BA02#
			±0.25pF		GRM0222C1C6R3CA02#
			6.6pF	±0.5pF	GRM0222C1C6R3DA02#
				±0.05pF	GRM0222C1C6R4WA02#
					±0.1pF
			6.7pF		±0.25pF
				±0.5pF	GRM0222C1C6R4DA02#
				6.8pF	±0.05pF
			±0.1pF		GRM0222C1C6R5BA02#
			±0.25pF		GRM0222C1C6R5CA02#
			6.9pF	±0.5pF	GRM0222C1C6R5DA02#
				±0.05pF	GRM0222C1C6R6WA02#
					±0.1pF
			7.0pF		±0.25pF
				±0.5pF	GRM0222C1C6R6DA02#

品番 #には包装仕様コードが入ります。

GRMシリーズ
 GJMシリーズ
 GMAシリーズ
 GMDシリーズ
 GQMシリーズ
 GRJシリーズ
 GR3シリーズ
 KRMシリーズ
 KR3シリーズ
 LLAシリーズ
 LLLシリーズ
 LLMシリーズ
 LLRシリーズ
 △注意/
 使用上の注意

GRMシリーズ 温度補償用 品番表

(→ ■0.4×0.2mm)

T寸法 最大値	定格 電圧	温度 特性	静電容量	許容差	品番
0.22mm	16Vdc	CH	7.0pF	±0.1pF	GRM0222C1C7R0BA02#
				±0.25pF	GRM0222C1C7R0CA02#
				±0.5pF	GRM0222C1C7R0DA02#
			7.1pF	±0.05pF	GRM0222C1C7R1WA02#
				±0.1pF	GRM0222C1C7R1BA02#
				±0.25pF	GRM0222C1C7R1CA02#
			7.2pF	±0.05pF	GRM0222C1C7R2WA02#
				±0.1pF	GRM0222C1C7R2BA02#
				±0.25pF	GRM0222C1C7R2CA02#
			7.3pF	±0.05pF	GRM0222C1C7R3WA02#
				±0.1pF	GRM0222C1C7R3BA02#
				±0.25pF	GRM0222C1C7R3CA02#
			7.4pF	±0.05pF	GRM0222C1C7R4WA02#
				±0.1pF	GRM0222C1C7R4BA02#
				±0.25pF	GRM0222C1C7R4CA02#
			7.5pF	±0.05pF	GRM0222C1C7R5WA02#
				±0.1pF	GRM0222C1C7R5BA02#
				±0.25pF	GRM0222C1C7R5CA02#
			7.6pF	±0.05pF	GRM0222C1C7R6WA02#
				±0.1pF	GRM0222C1C7R6BA02#
				±0.25pF	GRM0222C1C7R6CA02#
			7.7pF	±0.05pF	GRM0222C1C7R7WA02#
				±0.1pF	GRM0222C1C7R7BA02#
				±0.25pF	GRM0222C1C7R7CA02#
			7.8pF	±0.05pF	GRM0222C1C7R8WA02#
				±0.1pF	GRM0222C1C7R8BA02#
				±0.25pF	GRM0222C1C7R8CA02#
			7.9pF	±0.05pF	GRM0222C1C7R9WA02#
				±0.1pF	GRM0222C1C7R9BA02#
				±0.25pF	GRM0222C1C7R9CA02#
			8.0pF	±0.05pF	GRM0222C1C8R0WA02#
				±0.1pF	GRM0222C1C8R0BA02#
				±0.25pF	GRM0222C1C8R0CA02#
			8.1pF	±0.05pF	GRM0222C1C8R1WA02#
				±0.1pF	GRM0222C1C8R1BA02#
				±0.25pF	GRM0222C1C8R1CA02#
			8.2pF	±0.05pF	GRM0222C1C8R2WA02#
				±0.1pF	GRM0222C1C8R2BA02#
				±0.25pF	GRM0222C1C8R2CA02#
			8.3pF	±0.05pF	GRM0222C1C8R3WA02#
				±0.1pF	GRM0222C1C8R3BA02#
				±0.25pF	GRM0222C1C8R3CA02#

T寸法 最大値	定格 電圧	温度 特性	静電容量	許容差	品番
0.22mm	16Vdc	CH	8.3pF	±0.5pF	GRM0222C1C8R3DA02#
				±0.05pF	GRM0222C1C8R4WA02#
				±0.1pF	GRM0222C1C8R4BA02#
			8.4pF	±0.25pF	GRM0222C1C8R4CA02#
				±0.5pF	GRM0222C1C8R4DA02#
				8.5pF	±0.05pF
			±0.1pF		GRM0222C1C8R5BA02#
			±0.25pF		GRM0222C1C8R5CA02#
			8.6pF	±0.05pF	GRM0222C1C8R6WA02#
				±0.1pF	GRM0222C1C8R6BA02#
				±0.25pF	GRM0222C1C8R6CA02#
			8.7pF	±0.05pF	GRM0222C1C8R7WA02#
				±0.1pF	GRM0222C1C8R7BA02#
				±0.25pF	GRM0222C1C8R7CA02#
			8.8pF	±0.05pF	GRM0222C1C8R8WA02#
				±0.1pF	GRM0222C1C8R8BA02#
				±0.25pF	GRM0222C1C8R8CA02#
			8.9pF	±0.05pF	GRM0222C1C8R9WA02#
				±0.1pF	GRM0222C1C8R9BA02#
				±0.25pF	GRM0222C1C8R9CA02#
			9.0pF	±0.05pF	GRM0222C1C9R0WA02#
				±0.1pF	GRM0222C1C9R0BA02#
				±0.25pF	GRM0222C1C9R0CA02#
			9.1pF	±0.05pF	GRM0222C1C9R1WA02#
				±0.1pF	GRM0222C1C9R1BA02#
				±0.25pF	GRM0222C1C9R1CA02#
			9.2pF	±0.05pF	GRM0222C1C9R2WA02#
				±0.1pF	GRM0222C1C9R2BA02#
				±0.25pF	GRM0222C1C9R2CA02#
			9.3pF	±0.05pF	GRM0222C1C9R3WA02#
				±0.1pF	GRM0222C1C9R3BA02#
				±0.25pF	GRM0222C1C9R3CA02#
			9.4pF	±0.05pF	GRM0222C1C9R4WA02#
				±0.1pF	GRM0222C1C9R4BA02#
				±0.25pF	GRM0222C1C9R4CA02#
			9.5pF	±0.05pF	GRM0222C1C9R5WA02#
				±0.1pF	GRM0222C1C9R5BA02#
				±0.25pF	GRM0222C1C9R5CA02#
			9.6pF	±0.05pF	GRM0222C1C9R6WA02#
				±0.1pF	GRM0222C1C9R6BA02#
				±0.25pF	GRM0222C1C9R6CA02#
			9.7pF	±0.05pF	GRM0222C1C9R7WA02#
				±0.1pF	GRM0222C1C9R7BA02#
				±0.25pF	GRM0222C1C9R7CA02#

品番 #には包装仕様コードが入ります。

GRMシリーズ
 GJMシリーズ
 GMAシリーズ
 GMDシリーズ
 GQMシリーズ
 GRJシリーズ
 GR3シリーズ
 KRMシリーズ
 KR3シリーズ
 LLAシリーズ
 LLLシリーズ
 LLMシリーズ
 LLRシリーズ
 △注意/
 使用上の注意

GRMシリーズ 温度補償用 品番表

(→ ■0.4×0.2mm)

T寸法 最大値	定格 電圧	温度 特性	静電容量	許容差	品番
0.22mm	16Vdc	CH	9.7pF	±0.1pF	GRM0222C1C9R7BA02#
				±0.25pF	GRM0222C1C9R7CA02#
				±0.5pF	GRM0222C1C9R7DA02#
			9.8pF	±0.05pF	GRM0222C1C9R8WA02#
				±0.1pF	GRM0222C1C9R8BA02#
				±0.25pF	GRM0222C1C9R8CA02#
			9.9pF	±0.05pF	GRM0222C1C9R9WA02#
				±0.1pF	GRM0222C1C9R9BA02#
				±0.25pF	GRM0222C1C9R9CA02#
			10pF	±2%	GRM0222C1C100GA02#
				±5%	GRM0222C1C100JA02#
			10.5pF	±2%	GRM0222C1C10EGA02#
			11pF	±2%	GRM0222C1C110GA02#
				±5%	GRM0222C1C110JA02#
			12pF	±2%	GRM0222C1C120GA02#
				±5%	GRM0222C1C120JA02#
			12.5pF	±2%	GRM0222C1C12EGA02#
			13pF	±2%	GRM0222C1C130GA02#
				±5%	GRM0222C1C130JA02#
			14pF	±2%	GRM0222C1C140GA02#
				±5%	GRM0222C1C140JA02#
			15pF	±2%	GRM0222C1C150GA02#
				±5%	GRM0222C1C150JA02#
			16pF	±2%	GRM0222C1C160GA02#
				±5%	GRM0222C1C160JA02#
			17pF	±2%	GRM0222C1C170GA02#
				±5%	GRM0222C1C170JA02#
			18pF	±2%	GRM0222C1C180GA02#
				±5%	GRM0222C1C180JA02#
			19pF	±2%	GRM0222C1C190GA02#
				±5%	GRM0222C1C190JA02#
			20pF	±2%	GRM0222C1C200GA02#
				±5%	GRM0222C1C200JA02#
			21pF	±2%	GRM0222C1C210GA02#
				±5%	GRM0222C1C210JA02#
			22pF	±2%	GRM0222C1C220GA02#
				±5%	GRM0222C1C220JA02#
			24pF	±2%	GRM0222C1C240GA02#
				±5%	GRM0222C1C240JA02#
			27pF	±2%	GRM0222C1C270GA02#
				±5%	GRM0222C1C270JA02#
			30pF	±2%	GRM0222C1C300GA02#
				±5%	GRM0222C1C300JA02#
			33pF	±2%	GRM0222C1C330GA02#
				±5%	GRM0222C1C330JA02#
			36pF	±2%	GRM0222C1C360GA02#
				±5%	GRM0222C1C360JA02#
			39pF	±2%	GRM0222C1C390GA02#
±5%	GRM0222C1C390JA02#				
43pF	±2%	GRM0222C1C430GA02#			
	±5%	GRM0222C1C430JA02#			
47pF	±2%	GRM0222C1C470GA02#			

T寸法 最大値	定格 電圧	温度 特性	静電容量	許容差	品番		
0.22mm	16Vdc	CH	47pF	±5%	GRM0222C1C470JA02#		
				±2%	GRM0222C1C510GA02#		
			51pF	±2%	GRM0222C1C510GA02#		
				±5%	GRM0222C1C510JA02#		
			56pF	±2%	GRM0222C1C560GA02#		
				±5%	GRM0222C1C560JA02#		
			62pF	±2%	GRM0222C1C620GA02#		
				±5%	GRM0222C1C620JA02#		
			68pF	±2%	GRM0222C1C680GA02#		
				±5%	GRM0222C1C680JA02#		
			75pF	±2%	GRM0222C1C750GA02#		
				±5%	GRM0222C1C750JA02#		
			82pF	±2%	GRM0222C1C820GA02#		
				±5%	GRM0222C1C820JA02#		
			91pF	±2%	GRM0222C1C910GA02#		
				±5%	GRM0222C1C910JA02#		
			100pF	±2%	GRM0222C1C101GA02#		
				±5%	GRM0222C1C101JA02#		
			COG	16Vdc	0.20pF	±0.05pF	GRM0225C1CR20WA02#
						±0.1pF	GRM0225C1CR20BA02#
					0.30pF	±0.05pF	GRM0225C1CR30WA02#
						±0.1pF	GRM0225C1CR30BA02#
					0.40pF	±0.05pF	GRM0225C1CR40WA02#
						±0.1pF	GRM0225C1CR40BA02#
		0.50pF			±0.05pF	GRM0225C1CR50WA02#	
					±0.1pF	GRM0225C1CR50BA02#	
		0.60pF			±0.05pF	GRM0225C1CR60WA02#	
					±0.1pF	GRM0225C1CR60BA02#	
		0.70pF			±0.05pF	GRM0225C1CR70WA02#	
					±0.1pF	GRM0225C1CR70BA02#	
		0.80pF			±0.05pF	GRM0225C1CR80WA02#	
					±0.1pF	GRM0225C1CR80BA02#	
		0.90pF			±0.05pF	GRM0225C1CR90WA02#	
					±0.1pF	GRM0225C1CR90BA02#	
		1.0pF			±0.05pF	GRM0225C1C1R0WA02#	
					±0.1pF	GRM0225C1C1R0BA02#	
					±0.25pF	GRM0225C1C1R0CA02#	
		1.1pF			±0.05pF	GRM0225C1C1R1WA02#	
					±0.1pF	GRM0225C1C1R1BA02#	
					±0.25pF	GRM0225C1C1R1CA02#	
		1.2pF			±0.05pF	GRM0225C1C1R2WA02#	
					±0.1pF	GRM0225C1C1R2BA02#	
			±0.25pF	GRM0225C1C1R2CA02#			
		1.3pF	±0.05pF	GRM0225C1C1R3WA02#			
			±0.1pF	GRM0225C1C1R3BA02#			
			±0.25pF	GRM0225C1C1R3CA02#			
		1.4pF	±0.05pF	GRM0225C1C1R4WA02#			
			±0.1pF	GRM0225C1C1R4BA02#			
±0.25pF	GRM0225C1C1R4CA02#						
1.5pF	±0.05pF	GRM0225C1C1R5WA02#					
	±0.1pF	GRM0225C1C1R5BA02#					
	±0.25pF	GRM0225C1C1R5CA02#					
1.6pF	±0.05pF	GRM0225C1C1R6WA02#					
	±0.1pF	GRM0225C1C1R6BA02#					
	±0.25pF	GRM0225C1C1R6CA02#					

品番 #には包装仕様コードが入ります。

GRMシリーズ
 GJMシリーズ
 GMAシリーズ
 GMDシリーズ
 GGMシリーズ
 GRJシリーズ
 GR3シリーズ
 KRMシリーズ
 KR3シリーズ
 LLAシリーズ
 LLLシリーズ
 LLMシリーズ
 LLRシリーズ
 △注意/
 使用上の注意

GRMシリーズ 温度補償用 品番表

(→ ■0.4×0.2mm)

T寸法 最大値	定格 電圧	温度 特性	静電容量	許容差	品番
0.22mm	16Vdc	COG	1.7pF	±0.05pF	GRM0225C1C1R7WA02#
				±0.1pF	GRM0225C1C1R7BA02#
				±0.25pF	GRM0225C1C1R7CA02#
			1.8pF	±0.05pF	GRM0225C1C1R8WA02#
				±0.1pF	GRM0225C1C1R8BA02#
				±0.25pF	GRM0225C1C1R8CA02#
			1.9pF	±0.05pF	GRM0225C1C1R9WA02#
				±0.1pF	GRM0225C1C1R9BA02#
				±0.25pF	GRM0225C1C1R9CA02#
			2.0pF	±0.05pF	GRM0225C1C2R0WA02#
				±0.1pF	GRM0225C1C2R0BA02#
				±0.25pF	GRM0225C1C2R0CA02#
			2.1pF	±0.05pF	GRM0225C1C2R1WA02#
				±0.1pF	GRM0225C1C2R1BA02#
				±0.25pF	GRM0225C1C2R1CA02#
			2.2pF	±0.05pF	GRM0225C1C2R2WA02#
				±0.1pF	GRM0225C1C2R2BA02#
				±0.25pF	GRM0225C1C2R2CA02#
			2.3pF	±0.05pF	GRM0225C1C2R3WA02#
				±0.1pF	GRM0225C1C2R3BA02#
				±0.25pF	GRM0225C1C2R3CA02#
			2.4pF	±0.05pF	GRM0225C1C2R4WA02#
				±0.1pF	GRM0225C1C2R4BA02#
				±0.25pF	GRM0225C1C2R4CA02#
			2.5pF	±0.05pF	GRM0225C1C2R5WA02#
				±0.1pF	GRM0225C1C2R5BA02#
				±0.25pF	GRM0225C1C2R5CA02#
			2.6pF	±0.05pF	GRM0225C1C2R6WA02#
				±0.1pF	GRM0225C1C2R6BA02#
				±0.25pF	GRM0225C1C2R6CA02#
			2.7pF	±0.05pF	GRM0225C1C2R7WA02#
				±0.1pF	GRM0225C1C2R7BA02#
				±0.25pF	GRM0225C1C2R7CA02#
			2.8pF	±0.05pF	GRM0225C1C2R8WA02#
				±0.1pF	GRM0225C1C2R8BA02#
				±0.25pF	GRM0225C1C2R8CA02#
			2.9pF	±0.05pF	GRM0225C1C2R9WA02#
				±0.1pF	GRM0225C1C2R9BA02#
				±0.25pF	GRM0225C1C2R9CA02#
			3.0pF	±0.05pF	GRM0225C1C3R0WA02#
				±0.1pF	GRM0225C1C3R0BA02#
				±0.25pF	GRM0225C1C3R0CA02#
			3.1pF	±0.05pF	GRM0225C1C3R1WA02#
				±0.1pF	GRM0225C1C3R1BA02#
				±0.25pF	GRM0225C1C3R1CA02#
			3.2pF	±0.05pF	GRM0225C1C3R2WA02#
				±0.1pF	GRM0225C1C3R2BA02#
				±0.25pF	GRM0225C1C3R2CA02#
3.3pF	±0.05pF	GRM0225C1C3R3WA02#			
	±0.1pF	GRM0225C1C3R3BA02#			
	±0.25pF	GRM0225C1C3R3CA02#			
3.4pF	±0.05pF	GRM0225C1C3R4WA02#			
	±0.1pF	GRM0225C1C3R4BA02#			
	±0.25pF	GRM0225C1C3R4CA02#			

T寸法 最大値	定格 電圧	温度 特性	静電容量	許容差	品番
0.22mm	16Vdc	COG	3.5pF	±0.05pF	GRM0225C1C3R5WA02#
				±0.1pF	GRM0225C1C3R5BA02#
				±0.25pF	GRM0225C1C3R5CA02#
			3.6pF	±0.05pF	GRM0225C1C3R6WA02#
				±0.1pF	GRM0225C1C3R6BA02#
				±0.25pF	GRM0225C1C3R6CA02#
			3.7pF	±0.05pF	GRM0225C1C3R7WA02#
				±0.1pF	GRM0225C1C3R7BA02#
				±0.25pF	GRM0225C1C3R7CA02#
			3.8pF	±0.05pF	GRM0225C1C3R8WA02#
				±0.1pF	GRM0225C1C3R8BA02#
				±0.25pF	GRM0225C1C3R8CA02#
			3.9pF	±0.05pF	GRM0225C1C3R9WA02#
				±0.1pF	GRM0225C1C3R9BA02#
				±0.25pF	GRM0225C1C3R9CA02#
			4.0pF	±0.05pF	GRM0225C1C4R0WA02#
				±0.1pF	GRM0225C1C4R0BA02#
				±0.25pF	GRM0225C1C4R0CA02#
			4.1pF	±0.05pF	GRM0225C1C4R1WA02#
				±0.1pF	GRM0225C1C4R1BA02#
				±0.25pF	GRM0225C1C4R1CA02#
			4.2pF	±0.05pF	GRM0225C1C4R2WA02#
				±0.1pF	GRM0225C1C4R2BA02#
				±0.25pF	GRM0225C1C4R2CA02#
			4.3pF	±0.05pF	GRM0225C1C4R3WA02#
				±0.1pF	GRM0225C1C4R3BA02#
				±0.25pF	GRM0225C1C4R3CA02#
			4.4pF	±0.05pF	GRM0225C1C4R4WA02#
				±0.1pF	GRM0225C1C4R4BA02#
				±0.25pF	GRM0225C1C4R4CA02#
			4.5pF	±0.05pF	GRM0225C1C4R5WA02#
				±0.1pF	GRM0225C1C4R5BA02#
				±0.25pF	GRM0225C1C4R5CA02#
			4.6pF	±0.05pF	GRM0225C1C4R6WA02#
				±0.1pF	GRM0225C1C4R6BA02#
				±0.25pF	GRM0225C1C4R6CA02#
			4.7pF	±0.05pF	GRM0225C1C4R7WA02#
				±0.1pF	GRM0225C1C4R7BA02#
				±0.25pF	GRM0225C1C4R7CA02#
			4.8pF	±0.05pF	GRM0225C1C4R8WA02#
				±0.1pF	GRM0225C1C4R8BA02#
				±0.25pF	GRM0225C1C4R8CA02#
			4.9pF	±0.05pF	GRM0225C1C4R9WA02#
				±0.1pF	GRM0225C1C4R9BA02#
				±0.25pF	GRM0225C1C4R9CA02#
			5.0pF	±0.05pF	GRM0225C1C5R0WA02#
				±0.1pF	GRM0225C1C5R0BA02#
				±0.25pF	GRM0225C1C5R0CA02#
5.1pF	±0.05pF	GRM0225C1C5R1WA02#			
	±0.1pF	GRM0225C1C5R1BA02#			
	±0.25pF	GRM0225C1C5R1CA02#			
5.2pF	±0.05pF	GRM0225C1C5R2WA02#			
	±0.1pF	GRM0225C1C5R2BA02#			

品番 #には包装仕様コードが入ります。

GRMシリーズ 温度補償用 品番表

(→ ■0.4×0.2mm)

T寸法 最大値	定格 電圧	温度 特性	静電容量	許容差	品番
0.22mm	16Vdc	C0G	5.2pF	±0.25pF	GRM0225C1C5R2CA02#
				±0.5pF	GRM0225C1C5R2DA02#
				±0.05pF	GRM0225C1C5R3WA02#
			5.3pF	±0.1pF	GRM0225C1C5R3BA02#
				±0.25pF	GRM0225C1C5R3CA02#
				±0.5pF	GRM0225C1C5R3DA02#
			5.4pF	±0.05pF	GRM0225C1C5R4WA02#
				±0.1pF	GRM0225C1C5R4BA02#
				±0.25pF	GRM0225C1C5R4CA02#
			5.5pF	±0.05pF	GRM0225C1C5R5WA02#
				±0.1pF	GRM0225C1C5R5BA02#
				±0.25pF	GRM0225C1C5R5CA02#
			5.6pF	±0.05pF	GRM0225C1C5R6WA02#
				±0.1pF	GRM0225C1C5R6BA02#
				±0.25pF	GRM0225C1C5R6CA02#
			5.7pF	±0.05pF	GRM0225C1C5R7WA02#
				±0.1pF	GRM0225C1C5R7BA02#
				±0.25pF	GRM0225C1C5R7CA02#
			5.8pF	±0.05pF	GRM0225C1C5R8WA02#
				±0.1pF	GRM0225C1C5R8BA02#
				±0.25pF	GRM0225C1C5R8CA02#
			5.9pF	±0.05pF	GRM0225C1C5R9WA02#
				±0.1pF	GRM0225C1C5R9BA02#
				±0.25pF	GRM0225C1C5R9CA02#
			6.0pF	±0.05pF	GRM0225C1C6R0WA02#
				±0.1pF	GRM0225C1C6R0BA02#
				±0.25pF	GRM0225C1C6R0CA02#
			6.1pF	±0.05pF	GRM0225C1C6R1WA02#
				±0.1pF	GRM0225C1C6R1BA02#
				±0.25pF	GRM0225C1C6R1CA02#
			6.2pF	±0.05pF	GRM0225C1C6R2WA02#
				±0.1pF	GRM0225C1C6R2BA02#
				±0.25pF	GRM0225C1C6R2CA02#
			6.3pF	±0.05pF	GRM0225C1C6R3WA02#
				±0.1pF	GRM0225C1C6R3BA02#
				±0.25pF	GRM0225C1C6R3CA02#
			6.4pF	±0.05pF	GRM0225C1C6R4WA02#
				±0.1pF	GRM0225C1C6R4BA02#
				±0.25pF	GRM0225C1C6R4CA02#
			6.5pF	±0.05pF	GRM0225C1C6R5WA02#
				±0.1pF	GRM0225C1C6R5BA02#
				±0.25pF	GRM0225C1C6R5CA02#
			6.6pF	±0.05pF	GRM0225C1C6R6WA02#
				±0.1pF	GRM0225C1C6R6BA02#
				±0.25pF	GRM0225C1C6R6CA02#
6.7pF	±0.05pF	GRM0225C1C6R7WA02#			
	±0.1pF	GRM0225C1C6R7BA02#			
	±0.25pF	GRM0225C1C6R7CA02#			
6.8pF	±0.05pF	GRM0225C1C6R8WA02#			
	±0.1pF	GRM0225C1C6R8BA02#			
	±0.25pF	GRM0225C1C6R8CA02#			
6.9pF	±0.05pF	GRM0225C1C6R9WA02#			
	±0.1pF	GRM0225C1C6R9BA02#			
	±0.25pF	GRM0225C1C6R9CA02#			
7.0pF	±0.05pF	GRM0225C1C7R0WA02#			
	±0.1pF	GRM0225C1C7R0BA02#			
	±0.25pF	GRM0225C1C7R0CA02#			
7.1pF	±0.05pF	GRM0225C1C7R1WA02#			
	±0.1pF	GRM0225C1C7R1BA02#			
	±0.25pF	GRM0225C1C7R1CA02#			
7.2pF	±0.05pF	GRM0225C1C7R2WA02#			
	±0.1pF	GRM0225C1C7R2BA02#			
	±0.25pF	GRM0225C1C7R2CA02#			
7.3pF	±0.05pF	GRM0225C1C7R3WA02#			
	±0.1pF	GRM0225C1C7R3BA02#			
	±0.25pF	GRM0225C1C7R3CA02#			
7.4pF	±0.05pF	GRM0225C1C7R4WA02#			
	±0.1pF	GRM0225C1C7R4BA02#			
	±0.25pF	GRM0225C1C7R4CA02#			
7.5pF	±0.05pF	GRM0225C1C7R5WA02#			
	±0.1pF	GRM0225C1C7R5BA02#			
	±0.25pF	GRM0225C1C7R5CA02#			
7.6pF	±0.05pF	GRM0225C1C7R6WA02#			
	±0.1pF	GRM0225C1C7R6BA02#			
	±0.25pF	GRM0225C1C7R6CA02#			
7.7pF	±0.05pF	GRM0225C1C7R7WA02#			
	±0.1pF	GRM0225C1C7R7BA02#			
	±0.25pF	GRM0225C1C7R7CA02#			
7.8pF	±0.05pF	GRM0225C1C7R8WA02#			
	±0.1pF	GRM0225C1C7R8BA02#			
	±0.25pF	GRM0225C1C7R8CA02#			
7.9pF	±0.05pF	GRM0225C1C7R9WA02#			
	±0.1pF	GRM0225C1C7R9BA02#			
	±0.25pF	GRM0225C1C7R9CA02#			

T寸法 最大値	定格 電圧	温度 特性	静電容量	許容差	品番
0.22mm	16Vdc	C0G	6.6pF	±0.05pF	GRM0225C1C6R6WA02#
				±0.1pF	GRM0225C1C6R6BA02#
				±0.25pF	GRM0225C1C6R6CA02#
			6.7pF	±0.05pF	GRM0225C1C6R7WA02#
				±0.1pF	GRM0225C1C6R7BA02#
				±0.25pF	GRM0225C1C6R7CA02#
			6.8pF	±0.05pF	GRM0225C1C6R8WA02#
				±0.1pF	GRM0225C1C6R8BA02#
				±0.25pF	GRM0225C1C6R8CA02#
			6.9pF	±0.05pF	GRM0225C1C6R9WA02#
				±0.1pF	GRM0225C1C6R9BA02#
				±0.25pF	GRM0225C1C6R9CA02#
			7.0pF	±0.05pF	GRM0225C1C7R0WA02#
				±0.1pF	GRM0225C1C7R0BA02#
				±0.25pF	GRM0225C1C7R0CA02#
			7.1pF	±0.05pF	GRM0225C1C7R1WA02#
				±0.1pF	GRM0225C1C7R1BA02#
				±0.25pF	GRM0225C1C7R1CA02#
			7.2pF	±0.05pF	GRM0225C1C7R2WA02#
				±0.1pF	GRM0225C1C7R2BA02#
				±0.25pF	GRM0225C1C7R2CA02#
			7.3pF	±0.05pF	GRM0225C1C7R3WA02#
				±0.1pF	GRM0225C1C7R3BA02#
				±0.25pF	GRM0225C1C7R3CA02#
			7.4pF	±0.05pF	GRM0225C1C7R4WA02#
				±0.1pF	GRM0225C1C7R4BA02#
				±0.25pF	GRM0225C1C7R4CA02#
			7.5pF	±0.05pF	GRM0225C1C7R5WA02#
				±0.1pF	GRM0225C1C7R5BA02#
				±0.25pF	GRM0225C1C7R5CA02#
			7.6pF	±0.05pF	GRM0225C1C7R6WA02#
				±0.1pF	GRM0225C1C7R6BA02#
				±0.25pF	GRM0225C1C7R6CA02#
			7.7pF	±0.05pF	GRM0225C1C7R7WA02#
				±0.1pF	GRM0225C1C7R7BA02#
				±0.25pF	GRM0225C1C7R7CA02#
			7.8pF	±0.05pF	GRM0225C1C7R8WA02#
				±0.1pF	GRM0225C1C7R8BA02#
				±0.25pF	GRM0225C1C7R8CA02#
			7.9pF	±0.05pF	GRM0225C1C7R9WA02#
				±0.1pF	GRM0225C1C7R9BA02#
				±0.25pF	GRM0225C1C7R9CA02#

品番 #には包装仕様コードが入ります。

GRMシリーズ
 GJMシリーズ
 GMAシリーズ
 GMDシリーズ
 GGMシリーズ
 GRJシリーズ
 GR3シリーズ
 KRMシリーズ
 KR3シリーズ
 LLAシリーズ
 LLLシリーズ
 LLMシリーズ
 LLRシリーズ
 △注意/
 使用上の注意

GRMシリーズ 温度補償用 品番表

(→ ■0.4×0.2mm)

T寸法 最大値	定格 電圧	温度 特性	静電容量	許容差	品番
0.22mm	16Vdc	C0G	7.9pF	±0.25pF	GRM0225C1C7R9CA02#
				±0.5pF	GRM0225C1C7R9DA02#
			8.0pF	±0.05pF	GRM0225C1C8R0WA02#
				±0.1pF	GRM0225C1C8R0BA02#
				±0.25pF	GRM0225C1C8R0CA02#
				±0.5pF	GRM0225C1C8R0DA02#
			8.1pF	±0.05pF	GRM0225C1C8R1WA02#
				±0.1pF	GRM0225C1C8R1BA02#
				±0.25pF	GRM0225C1C8R1CA02#
				±0.5pF	GRM0225C1C8R1DA02#
			8.2pF	±0.05pF	GRM0225C1C8R2WA02#
				±0.1pF	GRM0225C1C8R2BA02#
				±0.25pF	GRM0225C1C8R2CA02#
				±0.5pF	GRM0225C1C8R2DA02#
			8.3pF	±0.05pF	GRM0225C1C8R3WA02#
				±0.1pF	GRM0225C1C8R3BA02#
				±0.25pF	GRM0225C1C8R3CA02#
				±0.5pF	GRM0225C1C8R3DA02#
			8.4pF	±0.05pF	GRM0225C1C8R4WA02#
				±0.1pF	GRM0225C1C8R4BA02#
				±0.25pF	GRM0225C1C8R4CA02#
				±0.5pF	GRM0225C1C8R4DA02#
			8.5pF	±0.05pF	GRM0225C1C8R5WA02#
				±0.1pF	GRM0225C1C8R5BA02#
				±0.25pF	GRM0225C1C8R5CA02#
				±0.5pF	GRM0225C1C8R5DA02#
			8.6pF	±0.05pF	GRM0225C1C8R6WA02#
				±0.1pF	GRM0225C1C8R6BA02#
				±0.25pF	GRM0225C1C8R6CA02#
				±0.5pF	GRM0225C1C8R6DA02#
			8.7pF	±0.05pF	GRM0225C1C8R7WA02#
				±0.1pF	GRM0225C1C8R7BA02#
				±0.25pF	GRM0225C1C8R7CA02#
				±0.5pF	GRM0225C1C8R7DA02#
			8.8pF	±0.05pF	GRM0225C1C8R8WA02#
				±0.1pF	GRM0225C1C8R8BA02#
				±0.25pF	GRM0225C1C8R8CA02#
				±0.5pF	GRM0225C1C8R8DA02#
			8.9pF	±0.05pF	GRM0225C1C8R9WA02#
				±0.1pF	GRM0225C1C8R9BA02#
				±0.25pF	GRM0225C1C8R9CA02#
				±0.5pF	GRM0225C1C8R9DA02#
			9.0pF	±0.05pF	GRM0225C1C9R0WA02#
				±0.1pF	GRM0225C1C9R0BA02#
				±0.25pF	GRM0225C1C9R0CA02#
				±0.5pF	GRM0225C1C9R0DA02#
			9.1pF	±0.05pF	GRM0225C1C9R1WA02#
				±0.1pF	GRM0225C1C9R1BA02#
±0.25pF	GRM0225C1C9R1CA02#				
±0.5pF	GRM0225C1C9R1DA02#				
9.2pF	±0.05pF	GRM0225C1C9R2WA02#			
	±0.1pF	GRM0225C1C9R2BA02#			
	±0.25pF	GRM0225C1C9R2CA02#			
	±0.5pF	GRM0225C1C9R2DA02#			

T寸法 最大値	定格 電圧	温度 特性	静電容量	許容差	品番
0.22mm	16Vdc	C0G	9.3pF	±0.05pF	GRM0225C1C9R3WA02#
				±0.1pF	GRM0225C1C9R3BA02#
				±0.25pF	GRM0225C1C9R3CA02#
				±0.5pF	GRM0225C1C9R3DA02#
			9.4pF	±0.05pF	GRM0225C1C9R4WA02#
				±0.1pF	GRM0225C1C9R4BA02#
				±0.25pF	GRM0225C1C9R4CA02#
				±0.5pF	GRM0225C1C9R4DA02#
			9.5pF	±0.05pF	GRM0225C1C9R5WA02#
				±0.1pF	GRM0225C1C9R5BA02#
				±0.25pF	GRM0225C1C9R5CA02#
				±0.5pF	GRM0225C1C9R5DA02#
			9.6pF	±0.05pF	GRM0225C1C9R6WA02#
				±0.1pF	GRM0225C1C9R6BA02#
				±0.25pF	GRM0225C1C9R6CA02#
				±0.5pF	GRM0225C1C9R6DA02#
			9.7pF	±0.05pF	GRM0225C1C9R7WA02#
				±0.1pF	GRM0225C1C9R7BA02#
				±0.25pF	GRM0225C1C9R7CA02#
				±0.5pF	GRM0225C1C9R7DA02#
			9.8pF	±0.05pF	GRM0225C1C9R8WA02#
				±0.1pF	GRM0225C1C9R8BA02#
				±0.25pF	GRM0225C1C9R8CA02#
				±0.5pF	GRM0225C1C9R8DA02#
			9.9pF	±0.05pF	GRM0225C1C9R9WA02#
				±0.1pF	GRM0225C1C9R9BA02#
				±0.25pF	GRM0225C1C9R9CA02#
				±0.5pF	GRM0225C1C9R9DA02#
			10pF	±2%	GRM0225C1C100GA02#
				±5%	GRM0225C1C100JA02#
			11pF	±2%	GRM0225C1C110GA02#
				±5%	GRM0225C1C110JA02#
			12pF	±2%	GRM0225C1C120GA02#
				±5%	GRM0225C1C120JA02#
			13pF	±2%	GRM0225C1C130GA02#
				±5%	GRM0225C1C130JA02#
			14pF	±2%	GRM0225C1C140GA02#
				±5%	GRM0225C1C140JA02#
			15pF	±2%	GRM0225C1C150GA02#
				±5%	GRM0225C1C150JA02#
			16pF	±2%	GRM0225C1C160GA02#
				±5%	GRM0225C1C160JA02#
			17pF	±5%	GRM0225C1C170JA02#
				18pF	±2%
			±5%		GRM0225C1C180JA02#
			20pF	±2%	GRM0225C1C200GA02#
				±5%	GRM0225C1C200JA02#
			22pF	±2%	GRM0225C1C220GA02#
±5%	GRM0225C1C220JA02#				
24pF	±2%	GRM0225C1C240GA02#			
	±5%	GRM0225C1C240JA02#			
27pF	±2%	GRM0225C1C270GA02#			
	±5%	GRM0225C1C270JA02#			
30pF	±2%	GRM0225C1C300GA02#			

品番 #には包装仕様コードが入ります。

GRMシリーズ
GJMシリーズ
GMAシリーズ
GMDシリーズ
GQMシリーズ
GRJシリーズ
GR3シリーズ
KRMシリーズ
KR3シリーズ
LLAシリーズ
LLLシリーズ
LLMシリーズ
LLRシリーズ
△注意/
使用上の注意

GRMシリーズ 温度補償用 品番表

(→ ■0.4×0.2mm)

T寸法 最大値	定格 電圧	温度 特性	静電容量	許容差	品番		
0.22mm	16Vdc	C0G	30pF	±5%	GRM0225C1C300JA02#		
				±2%	GRM0225C1C330GA02#		
			33pF	±5%	GRM0225C1C330JA02#		
				±2%	GRM0225C1C360GA02#		
			36pF	±5%	GRM0225C1C360JA02#		
				±2%	GRM0225C1C390GA02#		
			39pF	±5%	GRM0225C1C390JA02#		
				±2%	GRM0225C1C430GA02#		
			43pF	±5%	GRM0225C1C430JA02#		
				±2%	GRM0225C1C470GA02#		
			47pF	±5%	GRM0225C1C470JA02#		
				±2%	GRM0225C1C510GA02#		
			51pF	±5%	GRM0225C1C510JA02#		
				±2%	GRM0225C1C560GA02#		
			56pF	±5%	GRM0225C1C560JA02#		
				±2%	GRM0225C1C620GA02#		
			62pF	±5%	GRM0225C1C620JA02#		
				±2%	GRM0225C1C680GA02#		
			68pF	±5%	GRM0225C1C680JA02#		
				±2%	GRM0225C1C750GA02#		
			75pF	±5%	GRM0225C1C750JA02#		
				±2%	GRM0225C1C820GA02#		
			82pF	±5%	GRM0225C1C820JA02#		
				±2%	GRM0225C1C910GA02#		
			91pF	±5%	GRM0225C1C910JA02#		
				±2%	GRM0225C1C940JA02#		
			94pF	±5%	GRM0225C1C960JA02#		
				±2%	GRM0225C1C101GA02#		
			100pF	±5%	GRM0225C1C101JA02#		
				10Vdc	CH	56pF	±2%
			±5%				GRM0222C1A560JD05#
			68pF			±2%	GRM0222C1A680GD05#
						±5%	GRM0222C1A680JD05#
			82pF			±2%	GRM0222C1A820GD05#
						±5%	GRM0222C1A820JD05#
			100pF		±2%	GRM0222C1A101GD05#	
±5%	GRM0222C1A101JD05#						
C0G	56pF	±2%	GRM0225C1A560GD05#				
		±5%	GRM0225C1A560JD05#				
	68pF	±2%	GRM0225C1A680GD05#				
		±5%	GRM0225C1A680JD05#				
	82pF	±2%	GRM0225C1A820GD05#				
		±5%	GRM0225C1A820JD05#				
100pF	±2%	GRM0225C1A101GD05#					
	±5%	GRM0225C1A101JD05#					

■0.6×0.3mm 超小型

T寸法 最大値	定格 電圧	温度 特性	静電容量	許容差	品番
0.33mm	100Vdc	CK	0.10pF	±0.05pF	GRM0334C2AR10WA01#
				±0.1pF	GRM0334C2AR20BA01#
			0.20pF	±0.05pF	GRM0334C2AR20WA01#
				±0.1pF	GRM0334C2AR20BA01#
0.30pF	±0.05pF	GRM0334C2AR30WA01#			
	±0.1pF	GRM0334C2AR30BA01#			

T寸法 最大値	定格 電圧	温度 特性	静電容量	許容差	品番
0.33mm	100Vdc	CK	0.30pF	±0.1pF	GRM0334C2AR30BA01#
				±0.05pF	GRM0334C2AR40WA01#
			0.40pF	±0.1pF	GRM0334C2AR40BA01#
				±0.05pF	GRM0334C2AR50WA01#
			0.50pF	±0.1pF	GRM0334C2AR50BA01#
				±0.05pF	GRM0334C2AR60WA01#
			0.60pF	±0.1pF	GRM0334C2AR60BA01#
				±0.05pF	GRM0334C2AR70WA01#
			0.70pF	±0.1pF	GRM0334C2AR70BA01#
				±0.05pF	GRM0334C2AR80WA01#
			0.80pF	±0.1pF	GRM0334C2AR80BA01#
				±0.05pF	GRM0334C2AR90WA01#
			0.90pF	±0.1pF	GRM0334C2AR90BA01#
				±0.05pF	GRM0334C2A1R0WA01#
			1.0pF	±0.1pF	GRM0334C2A1R0BA01#
				±0.25pF	GRM0334C2A1R0CA01#
				±0.05pF	GRM0334C2A1R1WA01#
			1.1pF	±0.1pF	GRM0334C2A1R1BA01#
				±0.25pF	GRM0334C2A1R1CA01#
				±0.05pF	GRM0334C2A1R2WA01#
			1.2pF	±0.1pF	GRM0334C2A1R2BA01#
				±0.25pF	GRM0334C2A1R2CA01#
				±0.05pF	GRM0334C2A1R3WA01#
			1.3pF	±0.1pF	GRM0334C2A1R3BA01#
		±0.25pF		GRM0334C2A1R3CA01#	
		±0.05pF		GRM0334C2A1R4WA01#	
		1.4pF	±0.1pF	GRM0334C2A1R4BA01#	
			±0.25pF	GRM0334C2A1R4CA01#	
			±0.05pF	GRM0334C2A1R5WA01#	
		1.5pF	±0.1pF	GRM0334C2A1R5BA01#	
			±0.25pF	GRM0334C2A1R5CA01#	
			±0.05pF	GRM0334C2A1R6WA01#	
		1.6pF	±0.1pF	GRM0334C2A1R6BA01#	
			±0.25pF	GRM0334C2A1R6CA01#	
			±0.05pF	GRM0334C2A1R7WA01#	
		1.7pF	±0.1pF	GRM0334C2A1R7BA01#	
			±0.25pF	GRM0334C2A1R7CA01#	
			±0.05pF	GRM0334C2A1R8WA01#	
		1.8pF	±0.1pF	GRM0334C2A1R8BA01#	
			±0.25pF	GRM0334C2A1R8CA01#	
			±0.05pF	GRM0334C2A1R9WA01#	
		1.9pF	±0.1pF	GRM0334C2A1R9BA01#	
			±0.25pF	GRM0334C2A1R9CA01#	
			±0.05pF	GRM0334C2A2R0WA01#	
		2.0pF	±0.1pF	GRM0334C2A2R0BA01#	
			±0.25pF	GRM0334C2A2R0CA01#	
			2.1pF	±0.1pF	GRM0333C2A2R1BA01#
		±0.25pF		GRM0333C2A2R1CA01#	
±0.05pF	GRM0333C2A2R2WA01#				
2.2pF	±0.1pF	GRM0333C2A2R2BA01#			
	±0.25pF	GRM0333C2A2R2CA01#			
	2.3pF	±0.05pF	GRM0333C2A2R3WA01#		
±0.1pF		GRM0333C2A2R3BA01#			
CJ	100Vdc	CK	2.1pF	±0.05pF	GRM0333C2A2R1WA01#
				±0.1pF	GRM0333C2A2R1BA01#
			2.2pF	±0.05pF	GRM0333C2A2R2WA01#
				±0.1pF	GRM0333C2A2R2BA01#
			2.3pF	±0.05pF	GRM0333C2A2R3WA01#
				±0.1pF	GRM0333C2A2R3BA01#

品番 #には包装仕様コードが入ります。

GRMシリーズ
 GJMシリーズ
 GMAシリーズ
 GMDシリーズ
 GQMシリーズ
 GRJシリーズ
 GR3シリーズ
 KRMシリーズ
 KR3シリーズ
 LLAシリーズ
 LLLシリーズ
 LLMシリーズ
 LLRシリーズ
 △注意/
 使用上の注意

GRMシリーズ 温度補償用 品番表

(→ ■0.6×0.3mm)

T寸法 最大値	定格 電圧	温度 特性	静電容量	許容差	品番
0.33mm	100Vdc	CJ	2.3pF	±0.25pF	GRM0333C2A2R3CA01#
				±0.05pF	GRM0333C2A2R4WA01#
					±0.1pF
			±0.25pF		GRM0333C2A2R4CA01#
			2.5pF	±0.05pF	GRM0333C2A2R5WA01#
				±0.1pF	GRM0333C2A2R5BA01#
				±0.25pF	GRM0333C2A2R5CA01#
			2.6pF	±0.05pF	GRM0333C2A2R6WA01#
				±0.1pF	GRM0333C2A2R6BA01#
				±0.25pF	GRM0333C2A2R6CA01#
			2.7pF	±0.05pF	GRM0333C2A2R7WA01#
				±0.1pF	GRM0333C2A2R7BA01#
				±0.25pF	GRM0333C2A2R7CA01#
			2.8pF	±0.05pF	GRM0333C2A2R8WA01#
				±0.1pF	GRM0333C2A2R8BA01#
				±0.25pF	GRM0333C2A2R8CA01#
			2.9pF	±0.05pF	GRM0333C2A2R9WA01#
				±0.1pF	GRM0333C2A2R9BA01#
				±0.25pF	GRM0333C2A2R9CA01#
			3.0pF	±0.05pF	GRM0333C2A3R0WA01#
				±0.1pF	GRM0333C2A3R0BA01#
				±0.25pF	GRM0333C2A3R0CA01#
			3.1pF	±0.05pF	GRM0333C2A3R1WA01#
				±0.1pF	GRM0333C2A3R1BA01#
				±0.25pF	GRM0333C2A3R1CA01#
			3.2pF	±0.05pF	GRM0333C2A3R2WA01#
				±0.1pF	GRM0333C2A3R2BA01#
				±0.25pF	GRM0333C2A3R2CA01#
			3.3pF	±0.05pF	GRM0333C2A3R3WA01#
				±0.1pF	GRM0333C2A3R3BA01#
				±0.25pF	GRM0333C2A3R3CA01#
			3.4pF	±0.05pF	GRM0333C2A3R4WA01#
				±0.1pF	GRM0333C2A3R4BA01#
				±0.25pF	GRM0333C2A3R4CA01#
			3.5pF	±0.05pF	GRM0333C2A3R5WA01#
				±0.1pF	GRM0333C2A3R5BA01#
		±0.25pF		GRM0333C2A3R5CA01#	
		3.6pF	±0.05pF	GRM0333C2A3R6WA01#	
			±0.1pF	GRM0333C2A3R6BA01#	
			±0.25pF	GRM0333C2A3R6CA01#	
		3.7pF	±0.05pF	GRM0333C2A3R7WA01#	
			±0.1pF	GRM0333C2A3R7BA01#	
			±0.25pF	GRM0333C2A3R7CA01#	
		3.8pF	±0.05pF	GRM0333C2A3R8WA01#	
			±0.1pF	GRM0333C2A3R8BA01#	
			±0.25pF	GRM0333C2A3R8CA01#	
		3.9pF	±0.05pF	GRM0333C2A3R9WA01#	
			±0.1pF	GRM0333C2A3R9BA01#	
±0.25pF	GRM0333C2A3R9CA01#				
CH	4.0pF	±0.05pF	GRM0332C2A4R0WA01#		
		±0.1pF	GRM0332C2A4R0BA01#		
		±0.25pF	GRM0332C2A4R0CA01#		
	4.1pF	±0.05pF	GRM0332C2A4R1WA01#		
		±0.1pF	GRM0332C2A4R1BA01#		

T寸法 最大値	定格 電圧	温度 特性	静電容量	許容差	品番
0.33mm	100Vdc	CH	4.1pF	±0.25pF	GRM0332C2A4R1CA01#
				±0.05pF	GRM0332C2A4R2WA01#
				±0.1pF	GRM0332C2A4R2BA01#
			4.2pF	±0.25pF	GRM0332C2A4R2CA01#
				±0.05pF	GRM0332C2A4R3WA01#
				±0.1pF	GRM0332C2A4R3BA01#
			4.3pF	±0.25pF	GRM0332C2A4R3CA01#
				±0.05pF	GRM0332C2A4R4WA01#
				±0.1pF	GRM0332C2A4R4BA01#
			4.4pF	±0.25pF	GRM0332C2A4R4CA01#
				±0.05pF	GRM0332C2A4R5WA01#
				±0.1pF	GRM0332C2A4R5BA01#
			4.5pF	±0.25pF	GRM0332C2A4R5CA01#
				±0.05pF	GRM0332C2A4R6WA01#
				±0.1pF	GRM0332C2A4R6BA01#
			4.6pF	±0.25pF	GRM0332C2A4R6CA01#
				±0.05pF	GRM0332C2A4R7WA01#
				±0.1pF	GRM0332C2A4R7BA01#
			4.7pF	±0.25pF	GRM0332C2A4R7CA01#
				±0.05pF	GRM0332C2A4R8WA01#
				±0.1pF	GRM0332C2A4R8BA01#
			4.8pF	±0.25pF	GRM0332C2A4R8CA01#
				±0.05pF	GRM0332C2A4R9WA01#
				±0.1pF	GRM0332C2A4R9BA01#
			4.9pF	±0.25pF	GRM0332C2A4R9CA01#
				±0.05pF	GRM0332C2A5R0WA01#
				±0.1pF	GRM0332C2A5R0BA01#
			5.0pF	±0.25pF	GRM0332C2A5R0CA01#
				±0.05pF	GRM0332C2A5R1WA01#
				±0.1pF	GRM0332C2A5R1BA01#
			5.1pF	±0.25pF	GRM0332C2A5R1CA01#
				±0.05pF	GRM0332C2A5R1DA01#
				±0.5pF	GRM0332C2A5R2WA01#
			5.2pF	±0.1pF	GRM0332C2A5R2BA01#
				±0.25pF	GRM0332C2A5R2CA01#
				±0.5pF	GRM0332C2A5R2DA01#
			5.3pF	±0.05pF	GRM0332C2A5R3WA01#
				±0.1pF	GRM0332C2A5R3BA01#
				±0.25pF	GRM0332C2A5R3CA01#
			5.4pF	±0.5pF	GRM0332C2A5R3DA01#
				±0.05pF	GRM0332C2A5R4WA01#
				±0.1pF	GRM0332C2A5R4BA01#
			5.5pF	±0.25pF	GRM0332C2A5R4CA01#
				±0.5pF	GRM0332C2A5R4DA01#
				±0.05pF	GRM0332C2A5R5WA01#
			5.6pF	±0.1pF	GRM0332C2A5R5BA01#
				±0.25pF	GRM0332C2A5R5CA01#
				±0.5pF	GRM0332C2A5R5DA01#
5.7pF	±0.05pF	GRM0332C2A5R6WA01#			
	±0.1pF	GRM0332C2A5R6BA01#			
	±0.25pF	GRM0332C2A5R6CA01#			
5.8pF	±0.5pF	GRM0332C2A5R6DA01#			
	±0.05pF	GRM0332C2A5R7WA01#			
	±0.1pF	GRM0332C2A5R7BA01#			

品番 #には包装仕様コードが入ります。

GRMシリーズ
GJMシリーズ
GMAシリーズ
GMDシリーズ
GQMシリーズ
GRJシリーズ
GR3シリーズ
KRMシリーズ
KR3シリーズ
LLAシリーズ
LLLシリーズ
LLMシリーズ
LLRシリーズ
△注意/
使用上の注意

GRMシリーズ 温度補償用 品番表

(→ ■0.6×0.3mm)

T寸法 最大値	定格 電圧	温度 特性	静電容量	許容差	品番
0.33mm	100Vdc	CH	5.7pF	±0.25pF	GRM0332C2A5R7CA01#
				±0.5pF	GRM0332C2A5R7DA01#
			5.8pF	±0.05pF	GRM0332C2A5R8WA01#
				±0.1pF	GRM0332C2A5R8BA01#
				±0.25pF	GRM0332C2A5R8CA01#
				±0.5pF	GRM0332C2A5R8DA01#
			5.9pF	±0.05pF	GRM0332C2A5R9WA01#
				±0.1pF	GRM0332C2A5R9BA01#
				±0.25pF	GRM0332C2A5R9CA01#
				±0.5pF	GRM0332C2A5R9DA01#
			6.0pF	±0.05pF	GRM0332C2A6R0WA01#
				±0.1pF	GRM0332C2A6R0BA01#
				±0.25pF	GRM0332C2A6R0CA01#
				±0.5pF	GRM0332C2A6R0DA01#
			6.1pF	±0.05pF	GRM0332C2A6R1WA01#
				±0.1pF	GRM0332C2A6R1BA01#
				±0.25pF	GRM0332C2A6R1CA01#
				±0.5pF	GRM0332C2A6R1DA01#
			6.2pF	±0.05pF	GRM0332C2A6R2WA01#
				±0.1pF	GRM0332C2A6R2BA01#
				±0.25pF	GRM0332C2A6R2CA01#
				±0.5pF	GRM0332C2A6R2DA01#
			6.3pF	±0.05pF	GRM0332C2A6R3WA01#
				±0.1pF	GRM0332C2A6R3BA01#
				±0.25pF	GRM0332C2A6R3CA01#
				±0.5pF	GRM0332C2A6R3DA01#
			6.4pF	±0.05pF	GRM0332C2A6R4WA01#
				±0.1pF	GRM0332C2A6R4BA01#
				±0.25pF	GRM0332C2A6R4CA01#
				±0.5pF	GRM0332C2A6R4DA01#
			6.5pF	±0.05pF	GRM0332C2A6R5WA01#
				±0.1pF	GRM0332C2A6R5BA01#
				±0.25pF	GRM0332C2A6R5CA01#
				±0.5pF	GRM0332C2A6R5DA01#
			6.6pF	±0.05pF	GRM0332C2A6R6WA01#
				±0.1pF	GRM0332C2A6R6BA01#
				±0.25pF	GRM0332C2A6R6CA01#
				±0.5pF	GRM0332C2A6R6DA01#
			6.7pF	±0.05pF	GRM0332C2A6R7WA01#
				±0.1pF	GRM0332C2A6R7BA01#
				±0.25pF	GRM0332C2A6R7CA01#
				±0.5pF	GRM0332C2A6R7DA01#
6.8pF	±0.05pF	GRM0332C2A6R8WA01#			
	±0.1pF	GRM0332C2A6R8BA01#			
	±0.25pF	GRM0332C2A6R8CA01#			
	±0.5pF	GRM0332C2A6R8DA01#			
6.9pF	±0.05pF	GRM0332C2A6R9WA01#			
	±0.1pF	GRM0332C2A6R9BA01#			
	±0.25pF	GRM0332C2A6R9CA01#			
	±0.5pF	GRM0332C2A6R9DA01#			
7.0pF	±0.05pF	GRM0332C2A7R0WA01#			
	±0.1pF	GRM0332C2A7R0BA01#			
	±0.25pF	GRM0332C2A7R0CA01#			
	±0.5pF	GRM0332C2A7R0DA01#			

T寸法 最大値	定格 電圧	温度 特性	静電容量	許容差	品番
0.33mm	100Vdc	CH	7.1pF	±0.05pF	GRM0332C2A7R1WA01#
				±0.1pF	GRM0332C2A7R1BA01#
				±0.25pF	GRM0332C2A7R1CA01#
				±0.5pF	GRM0332C2A7R1DA01#
			7.2pF	±0.05pF	GRM0332C2A7R2WA01#
				±0.1pF	GRM0332C2A7R2BA01#
				±0.25pF	GRM0332C2A7R2CA01#
				±0.5pF	GRM0332C2A7R2DA01#
			7.3pF	±0.05pF	GRM0332C2A7R3WA01#
				±0.1pF	GRM0332C2A7R3BA01#
				±0.25pF	GRM0332C2A7R3CA01#
				±0.5pF	GRM0332C2A7R3DA01#
			7.4pF	±0.05pF	GRM0332C2A7R4WA01#
				±0.1pF	GRM0332C2A7R4BA01#
				±0.25pF	GRM0332C2A7R4CA01#
				±0.5pF	GRM0332C2A7R4DA01#
			7.5pF	±0.05pF	GRM0332C2A7R5WA01#
				±0.1pF	GRM0332C2A7R5BA01#
				±0.25pF	GRM0332C2A7R5CA01#
				±0.5pF	GRM0332C2A7R5DA01#
			7.6pF	±0.05pF	GRM0332C2A7R6WA01#
				±0.1pF	GRM0332C2A7R6BA01#
				±0.25pF	GRM0332C2A7R6CA01#
				±0.5pF	GRM0332C2A7R6DA01#
			7.7pF	±0.05pF	GRM0332C2A7R7WA01#
				±0.1pF	GRM0332C2A7R7BA01#
				±0.25pF	GRM0332C2A7R7CA01#
				±0.5pF	GRM0332C2A7R7DA01#
			7.8pF	±0.05pF	GRM0332C2A7R8WA01#
				±0.1pF	GRM0332C2A7R8BA01#
				±0.25pF	GRM0332C2A7R8CA01#
				±0.5pF	GRM0332C2A7R8DA01#
			7.9pF	±0.05pF	GRM0332C2A7R9WA01#
				±0.1pF	GRM0332C2A7R9BA01#
				±0.25pF	GRM0332C2A7R9CA01#
				±0.5pF	GRM0332C2A7R9DA01#
			8.0pF	±0.05pF	GRM0332C2A8R0WA01#
				±0.1pF	GRM0332C2A8R0BA01#
				±0.25pF	GRM0332C2A8R0CA01#
				±0.5pF	GRM0332C2A8R0DA01#
			8.1pF	±0.05pF	GRM0332C2A8R1WA01#
				±0.1pF	GRM0332C2A8R1BA01#
	±0.25pF	GRM0332C2A8R1CA01#			
	±0.5pF	GRM0332C2A8R1DA01#			
8.2pF	±0.05pF	GRM0332C2A8R2WA01#			
	±0.1pF	GRM0332C2A8R2BA01#			
	±0.25pF	GRM0332C2A8R2CA01#			
	±0.5pF	GRM0332C2A8R2DA01#			
8.3pF	±0.05pF	GRM0332C2A8R3WA01#			
	±0.1pF	GRM0332C2A8R3BA01#			
	±0.25pF	GRM0332C2A8R3CA01#			
	±0.5pF	GRM0332C2A8R3DA01#			
8.4pF	±0.05pF	GRM0332C2A8R4WA01#			
	±0.1pF	GRM0332C2A8R4BA01#			

品番 #には包装仕様コードが入ります。

GRMシリーズ
 GJMシリーズ
 GMAシリーズ
 GMDシリーズ
 GQMシリーズ
 GRJシリーズ
 GR3シリーズ
 KRMシリーズ
 KR3シリーズ
 LLAシリーズ
 LLLシリーズ
 LLMシリーズ
 LLRシリーズ
 △注意/
 使用上の注意

GRMシリーズ 温度補償用 品番表

(→ ■0.6×0.3mm)

T寸法 最大値	定格 電圧	温度 特性	静電容量	許容差	品番
0.33mm	100Vdc	CH	8.4pF	±0.25pF	GRM0332C2A8R4CA01#
				±0.5pF	GRM0332C2A8R4DA01#
			8.5pF	±0.05pF	GRM0332C2A8R5WA01#
				±0.1pF	GRM0332C2A8R5BA01#
				±0.25pF	GRM0332C2A8R5CA01#
				±0.5pF	GRM0332C2A8R5DA01#
			8.6pF	±0.05pF	GRM0332C2A8R6WA01#
				±0.1pF	GRM0332C2A8R6BA01#
				±0.25pF	GRM0332C2A8R6CA01#
				±0.5pF	GRM0332C2A8R6DA01#
			8.7pF	±0.05pF	GRM0332C2A8R7WA01#
				±0.1pF	GRM0332C2A8R7BA01#
				±0.25pF	GRM0332C2A8R7CA01#
				±0.5pF	GRM0332C2A8R7DA01#
			8.8pF	±0.05pF	GRM0332C2A8R8WA01#
				±0.1pF	GRM0332C2A8R8BA01#
				±0.25pF	GRM0332C2A8R8CA01#
				±0.5pF	GRM0332C2A8R8DA01#
			8.9pF	±0.05pF	GRM0332C2A8R9WA01#
				±0.1pF	GRM0332C2A8R9BA01#
				±0.25pF	GRM0332C2A8R9CA01#
				±0.5pF	GRM0332C2A8R9DA01#
			9.0pF	±0.05pF	GRM0332C2A9R0WA01#
				±0.1pF	GRM0332C2A9R0BA01#
				±0.25pF	GRM0332C2A9R0CA01#
				±0.5pF	GRM0332C2A9R0DA01#
			9.1pF	±0.05pF	GRM0332C2A9R1WA01#
				±0.1pF	GRM0332C2A9R1BA01#
				±0.25pF	GRM0332C2A9R1CA01#
				±0.5pF	GRM0332C2A9R1DA01#
			9.2pF	±0.05pF	GRM0332C2A9R2WA01#
				±0.1pF	GRM0332C2A9R2BA01#
				±0.25pF	GRM0332C2A9R2CA01#
				±0.5pF	GRM0332C2A9R2DA01#
			9.3pF	±0.05pF	GRM0332C2A9R3WA01#
				±0.1pF	GRM0332C2A9R3BA01#
				±0.25pF	GRM0332C2A9R3CA01#
				±0.5pF	GRM0332C2A9R3DA01#
			9.4pF	±0.05pF	GRM0332C2A9R4WA01#
				±0.1pF	GRM0332C2A9R4BA01#
				±0.25pF	GRM0332C2A9R4CA01#
				±0.5pF	GRM0332C2A9R4DA01#
			9.5pF	±0.05pF	GRM0332C2A9R5WA01#
				±0.1pF	GRM0332C2A9R5BA01#
				±0.25pF	GRM0332C2A9R5CA01#
				±0.5pF	GRM0332C2A9R5DA01#
			9.6pF	±0.05pF	GRM0332C2A9R6WA01#
				±0.1pF	GRM0332C2A9R6BA01#
				±0.25pF	GRM0332C2A9R6CA01#
				±0.5pF	GRM0332C2A9R6DA01#
			9.7pF	±0.05pF	GRM0332C2A9R7WA01#
				±0.1pF	GRM0332C2A9R7BA01#
				±0.25pF	GRM0332C2A9R7CA01#
				±0.5pF	GRM0332C2A9R7DA01#

T寸法 最大値	定格 電圧	温度 特性	静電容量	許容差	品番	
0.33mm	100Vdc	CH	9.8pF	±0.05pF	GRM0332C2A9R8WA01#	
				±0.1pF	GRM0332C2A9R8BA01#	
				±0.25pF	GRM0332C2A9R8CA01#	
				±0.5pF	GRM0332C2A9R8DA01#	
			9.9pF	±0.05pF	GRM0332C2A9R9WA01#	
				±0.1pF	GRM0332C2A9R9BA01#	
				±0.25pF	GRM0332C2A9R9CA01#	
				±0.5pF	GRM0332C2A9R9DA01#	
			10pF	±2%	GRM0332C2A100GA01#	
				±5%	GRM0332C2A100JA01#	
			12pF	±2%	GRM0332C2A120GA01#	
				±5%	GRM0332C2A120JA01#	
			15pF	±2%	GRM0332C2A150GA01#	
				±5%	GRM0332C2A150JA01#	
			COG	0.10pF	±0.05pF	GRM0335C2AR10WA01#
					±0.1pF	GRM0335C2AR10BA01#
				0.20pF	±0.05pF	GRM0335C2AR20WA01#
					±0.1pF	GRM0335C2AR20BA01#
				0.30pF	±0.05pF	GRM0335C2AR30WA01#
					±0.1pF	GRM0335C2AR30BA01#
				0.40pF	±0.05pF	GRM0335C2AR40WA01#
					±0.1pF	GRM0335C2AR40BA01#
				0.50pF	±0.05pF	GRM0335C2AR50WA01#
					±0.1pF	GRM0335C2AR50BA01#
		0.60pF		±0.05pF	GRM0335C2AR60WA01#	
				±0.1pF	GRM0335C2AR60BA01#	
		0.70pF		±0.05pF	GRM0335C2AR70WA01#	
				±0.1pF	GRM0335C2AR70BA01#	
		0.80pF		±0.05pF	GRM0335C2AR80WA01#	
				±0.1pF	GRM0335C2AR80BA01#	
		0.90pF		±0.05pF	GRM0335C2AR90WA01#	
				±0.1pF	GRM0335C2AR90BA01#	
		1.0pF		±0.05pF	GRM0335C2A1R0WA01#	
				±0.1pF	GRM0335C2A1R0BA01#	
				±0.25pF	GRM0335C2A1R0CA01#	
				±0.5pF	GRM0335C2A1R0DA01#	
		1.1pF		±0.05pF	GRM0335C2A1R1WA01#	
				±0.1pF	GRM0335C2A1R1BA01#	
			±0.25pF	GRM0335C2A1R1CA01#		
			±0.5pF	GRM0335C2A1R1DA01#		
		1.2pF	±0.05pF	GRM0335C2A1R2WA01#		
			±0.1pF	GRM0335C2A1R2BA01#		
			±0.25pF	GRM0335C2A1R2CA01#		
		1.3pF	±0.05pF	GRM0335C2A1R3WA01#		
			±0.1pF	GRM0335C2A1R3BA01#		
			±0.25pF	GRM0335C2A1R3CA01#		
		1.4pF	±0.05pF	GRM0335C2A1R4WA01#		
			±0.1pF	GRM0335C2A1R4BA01#		
			±0.25pF	GRM0335C2A1R4CA01#		
		1.5pF	±0.05pF	GRM0335C2A1R5WA01#		
			±0.1pF	GRM0335C2A1R5BA01#		
			±0.25pF	GRM0335C2A1R5CA01#		
		1.6pF	±0.05pF	GRM0335C2A1R6WA01#		
			±0.1pF	GRM0335C2A1R6BA01#		
±0.25pF	GRM0335C2A1R6CA01#					
1.7pF	±0.05pF	GRM0335C2A1R7WA01#				
	±0.1pF	GRM0335C2A1R7BA01#				

品番 #には包装仕様コードが入ります。

GRMシリーズ
GJMシリーズ
GMAシリーズ
GMDシリーズ
GQMシリーズ
GRJシリーズ
GR3シリーズ
KRMシリーズ
KR3シリーズ
LLAシリーズ
LLLシリーズ
LLMシリーズ
LLRシリーズ
△注意/
使用上の注意

GRMシリーズ 温度補償用 品番表

(→ ■0.6×0.3mm)

T寸法 最大値	定格 電圧	温度 特性	静電容量	許容差	品番
0.33mm	100Vdc	C0G	1.7pF	±0.25pF	GRM0335C2A1R7CA01#
				±0.05pF	GRM0335C2A1R8WA01#
					±0.1pF
			±0.25pF		GRM0335C2A1R8CA01#
			1.9pF	±0.05pF	GRM0335C2A1R9WA01#
				±0.1pF	GRM0335C2A1R9BA01#
				±0.25pF	GRM0335C2A1R9CA01#
			2.0pF	±0.05pF	GRM0335C2A2R0WA01#
				±0.1pF	GRM0335C2A2R0BA01#
				±0.25pF	GRM0335C2A2R0CA01#
			2.1pF	±0.05pF	GRM0335C2A2R1WA01#
				±0.1pF	GRM0335C2A2R1BA01#
				±0.25pF	GRM0335C2A2R1CA01#
			2.2pF	±0.05pF	GRM0335C2A2R2WA01#
				±0.1pF	GRM0335C2A2R2BA01#
				±0.25pF	GRM0335C2A2R2CA01#
			2.3pF	±0.05pF	GRM0335C2A2R3WA01#
				±0.1pF	GRM0335C2A2R3BA01#
				±0.25pF	GRM0335C2A2R3CA01#
			2.4pF	±0.05pF	GRM0335C2A2R4WA01#
				±0.1pF	GRM0335C2A2R4BA01#
				±0.25pF	GRM0335C2A2R4CA01#
			2.5pF	±0.05pF	GRM0335C2A2R5WA01#
				±0.1pF	GRM0335C2A2R5BA01#
				±0.25pF	GRM0335C2A2R5CA01#
			2.6pF	±0.05pF	GRM0335C2A2R6WA01#
				±0.1pF	GRM0335C2A2R6BA01#
				±0.25pF	GRM0335C2A2R6CA01#
			2.7pF	±0.05pF	GRM0335C2A2R7WA01#
				±0.1pF	GRM0335C2A2R7BA01#
				±0.25pF	GRM0335C2A2R7CA01#
			2.8pF	±0.05pF	GRM0335C2A2R8WA01#
				±0.1pF	GRM0335C2A2R8BA01#
				±0.25pF	GRM0335C2A2R8CA01#
			2.9pF	±0.05pF	GRM0335C2A2R9WA01#
				±0.1pF	GRM0335C2A2R9BA01#
				±0.25pF	GRM0335C2A2R9CA01#
			3.0pF	±0.05pF	GRM0335C2A3R0WA01#
				±0.1pF	GRM0335C2A3R0BA01#
				±0.25pF	GRM0335C2A3R0CA01#
			3.1pF	±0.05pF	GRM0335C2A3R1WA01#
				±0.1pF	GRM0335C2A3R1BA01#
				±0.25pF	GRM0335C2A3R1CA01#
			3.2pF	±0.05pF	GRM0335C2A3R2WA01#
				±0.1pF	GRM0335C2A3R2BA01#
±0.25pF	GRM0335C2A3R2CA01#				
3.3pF	±0.05pF	GRM0335C2A3R3WA01#			
	±0.1pF	GRM0335C2A3R3BA01#			
	±0.25pF	GRM0335C2A3R3CA01#			
3.4pF	±0.05pF	GRM0335C2A3R4WA01#			
	±0.1pF	GRM0335C2A3R4BA01#			
	±0.25pF	GRM0335C2A3R4CA01#			
3.5pF	±0.05pF	GRM0335C2A3R5WA01#			
	±0.1pF	GRM0335C2A3R5BA01#			

T寸法 最大値	定格 電圧	温度 特性	静電容量	許容差	品番
0.33mm	100Vdc	C0G	3.5pF	±0.25pF	GRM0335C2A3R5CA01#
				±0.05pF	GRM0335C2A3R6WA01#
					±0.1pF
			±0.25pF		GRM0335C2A3R6CA01#
			3.7pF	±0.05pF	GRM0335C2A3R7WA01#
				±0.1pF	GRM0335C2A3R7BA01#
				±0.25pF	GRM0335C2A3R7CA01#
			3.8pF	±0.05pF	GRM0335C2A3R8WA01#
				±0.1pF	GRM0335C2A3R8BA01#
				±0.25pF	GRM0335C2A3R8CA01#
			3.9pF	±0.05pF	GRM0335C2A3R9WA01#
				±0.1pF	GRM0335C2A3R9BA01#
				±0.25pF	GRM0335C2A3R9CA01#
			4.0pF	±0.05pF	GRM0335C2A4R0WA01#
				±0.1pF	GRM0335C2A4R0BA01#
				±0.25pF	GRM0335C2A4R0CA01#
			4.1pF	±0.05pF	GRM0335C2A4R1WA01#
				±0.1pF	GRM0335C2A4R1BA01#
				±0.25pF	GRM0335C2A4R1CA01#
			4.2pF	±0.05pF	GRM0335C2A4R2WA01#
				±0.1pF	GRM0335C2A4R2BA01#
				±0.25pF	GRM0335C2A4R2CA01#
			4.3pF	±0.05pF	GRM0335C2A4R3WA01#
				±0.1pF	GRM0335C2A4R3BA01#
				±0.25pF	GRM0335C2A4R3CA01#
			4.4pF	±0.05pF	GRM0335C2A4R4WA01#
				±0.1pF	GRM0335C2A4R4BA01#
				±0.25pF	GRM0335C2A4R4CA01#
			4.5pF	±0.05pF	GRM0335C2A4R5WA01#
				±0.1pF	GRM0335C2A4R5BA01#
				±0.25pF	GRM0335C2A4R5CA01#
			4.6pF	±0.05pF	GRM0335C2A4R6WA01#
				±0.1pF	GRM0335C2A4R6BA01#
				±0.25pF	GRM0335C2A4R6CA01#
			4.7pF	±0.05pF	GRM0335C2A4R7WA01#
				±0.1pF	GRM0335C2A4R7BA01#
				±0.25pF	GRM0335C2A4R7CA01#
			4.8pF	±0.05pF	GRM0335C2A4R8WA01#
				±0.1pF	GRM0335C2A4R8BA01#
				±0.25pF	GRM0335C2A4R8CA01#
			4.9pF	±0.05pF	GRM0335C2A4R9WA01#
				±0.1pF	GRM0335C2A4R9BA01#
				±0.25pF	GRM0335C2A4R9CA01#
			5.0pF	±0.05pF	GRM0335C2A5R0WA01#
				±0.1pF	GRM0335C2A5R0BA01#
±0.25pF	GRM0335C2A5R0CA01#				
5.1pF	±0.05pF	GRM0335C2A5R1WA01#			
	±0.1pF	GRM0335C2A5R1BA01#			
	±0.25pF	GRM0335C2A5R1CA01#			
5.2pF	±0.05pF	GRM0335C2A5R2WA01#			
	±0.1pF	GRM0335C2A5R2BA01#			
	±0.25pF	GRM0335C2A5R2CA01#			
5.2pF	±0.05pF	GRM0335C2A5R2DA01#			
	±0.5pF	GRM0335C2A5R2DA01#			

品番 #には包装仕様コードが入ります。

GRMシリーズ
 GJMシリーズ
 GMAシリーズ
 GMDシリーズ
 GQMシリーズ
 GRJシリーズ
 GR3シリーズ
 KRMシリーズ
 KR3シリーズ
 LLAシリーズ
 LLLシリーズ
 LLMシリーズ
 LLRシリーズ
 △注意/
 使用上の注意

GRMシリーズ 温度補償用 品番表

(→ ■0.6×0.3mm)

T寸法 最大値	定格 電圧	温度 特性	静電容量	許容差	品番
0.33mm	100Vdc	C0G	5.3pF	±0.05pF	GRM0335C2A5R3WA01#
				±0.1pF	GRM0335C2A5R3BA01#
				±0.25pF	GRM0335C2A5R3CA01#
				±0.5pF	GRM0335C2A5R3DA01#
			5.4pF	±0.05pF	GRM0335C2A5R4WA01#
				±0.1pF	GRM0335C2A5R4BA01#
				±0.25pF	GRM0335C2A5R4CA01#
				±0.5pF	GRM0335C2A5R4DA01#
			5.5pF	±0.05pF	GRM0335C2A5R5WA01#
				±0.1pF	GRM0335C2A5R5BA01#
				±0.25pF	GRM0335C2A5R5CA01#
				±0.5pF	GRM0335C2A5R5DA01#
			5.6pF	±0.05pF	GRM0335C2A5R6WA01#
				±0.1pF	GRM0335C2A5R6BA01#
				±0.25pF	GRM0335C2A5R6CA01#
				±0.5pF	GRM0335C2A5R6DA01#
			5.7pF	±0.05pF	GRM0335C2A5R7WA01#
				±0.1pF	GRM0335C2A5R7BA01#
				±0.25pF	GRM0335C2A5R7CA01#
				±0.5pF	GRM0335C2A5R7DA01#
			5.8pF	±0.05pF	GRM0335C2A5R8WA01#
				±0.1pF	GRM0335C2A5R8BA01#
				±0.25pF	GRM0335C2A5R8CA01#
				±0.5pF	GRM0335C2A5R8DA01#
			5.9pF	±0.05pF	GRM0335C2A5R9WA01#
				±0.1pF	GRM0335C2A5R9BA01#
				±0.25pF	GRM0335C2A5R9CA01#
				±0.5pF	GRM0335C2A5R9DA01#
			6.0pF	±0.05pF	GRM0335C2A6R0WA01#
				±0.1pF	GRM0335C2A6R0BA01#
				±0.25pF	GRM0335C2A6R0CA01#
				±0.5pF	GRM0335C2A6R0DA01#
			6.1pF	±0.05pF	GRM0335C2A6R1WA01#
				±0.1pF	GRM0335C2A6R1BA01#
				±0.25pF	GRM0335C2A6R1CA01#
				±0.5pF	GRM0335C2A6R1DA01#
			6.2pF	±0.05pF	GRM0335C2A6R2WA01#
				±0.1pF	GRM0335C2A6R2BA01#
				±0.25pF	GRM0335C2A6R2CA01#
				±0.5pF	GRM0335C2A6R2DA01#
			6.3pF	±0.05pF	GRM0335C2A6R3WA01#
				±0.1pF	GRM0335C2A6R3BA01#
				±0.25pF	GRM0335C2A6R3CA01#
				±0.5pF	GRM0335C2A6R3DA01#
			6.4pF	±0.05pF	GRM0335C2A6R4WA01#
				±0.1pF	GRM0335C2A6R4BA01#
				±0.25pF	GRM0335C2A6R4CA01#
				±0.5pF	GRM0335C2A6R4DA01#
6.5pF	±0.05pF	GRM0335C2A6R5WA01#			
	±0.1pF	GRM0335C2A6R5BA01#			
	±0.25pF	GRM0335C2A6R5CA01#			
	±0.5pF	GRM0335C2A6R5DA01#			
6.6pF	±0.05pF	GRM0335C2A6R6WA01#			
	±0.1pF	GRM0335C2A6R6BA01#			

T寸法 最大値	定格 電圧	温度 特性	静電容量	許容差	品番
0.33mm	100Vdc	C0G	6.6pF	±0.25pF	GRM0335C2A6R6CA01#
				±0.5pF	GRM0335C2A6R6DA01#
			6.7pF	±0.05pF	GRM0335C2A6R7WA01#
				±0.1pF	GRM0335C2A6R7BA01#
				±0.25pF	GRM0335C2A6R7CA01#
			6.8pF	±0.05pF	GRM0335C2A6R8WA01#
				±0.1pF	GRM0335C2A6R8BA01#
				±0.25pF	GRM0335C2A6R8CA01#
			6.9pF	±0.05pF	GRM0335C2A6R9WA01#
				±0.1pF	GRM0335C2A6R9BA01#
				±0.25pF	GRM0335C2A6R9CA01#
			7.0pF	±0.05pF	GRM0335C2A7R0WA01#
				±0.1pF	GRM0335C2A7R0BA01#
				±0.25pF	GRM0335C2A7R0CA01#
			7.1pF	±0.05pF	GRM0335C2A7R1WA01#
				±0.1pF	GRM0335C2A7R1BA01#
				±0.25pF	GRM0335C2A7R1CA01#
			7.2pF	±0.05pF	GRM0335C2A7R2WA01#
				±0.1pF	GRM0335C2A7R2BA01#
				±0.25pF	GRM0335C2A7R2CA01#
			7.3pF	±0.05pF	GRM0335C2A7R3WA01#
				±0.1pF	GRM0335C2A7R3BA01#
				±0.25pF	GRM0335C2A7R3CA01#
			7.4pF	±0.05pF	GRM0335C2A7R4WA01#
				±0.1pF	GRM0335C2A7R4BA01#
				±0.25pF	GRM0335C2A7R4CA01#
			7.5pF	±0.05pF	GRM0335C2A7R5WA01#
				±0.1pF	GRM0335C2A7R5BA01#
				±0.25pF	GRM0335C2A7R5CA01#
			7.6pF	±0.05pF	GRM0335C2A7R6WA01#
				±0.1pF	GRM0335C2A7R6BA01#
				±0.25pF	GRM0335C2A7R6CA01#
			7.7pF	±0.05pF	GRM0335C2A7R7WA01#
				±0.1pF	GRM0335C2A7R7BA01#
				±0.25pF	GRM0335C2A7R7CA01#
			7.8pF	±0.05pF	GRM0335C2A7R8WA01#
				±0.1pF	GRM0335C2A7R8BA01#
				±0.25pF	GRM0335C2A7R8CA01#
			7.9pF	±0.05pF	GRM0335C2A7R9WA01#
				±0.1pF	GRM0335C2A7R9BA01#
				±0.25pF	GRM0335C2A7R9CA01#

品番 #には包装仕様コードが入ります。

GRMシリーズ 温度補償用 品番表

(→ ■0.6×0.3mm)

T寸法 最大値	定格 電圧	温度 特性	静電容量	許容差	品番
0.33mm	100Vdc	C0G	8.0pF	±0.05pF	GRM0335C2A8R0WA01#
				±0.1pF	GRM0335C2A8R0BA01#
				±0.25pF	GRM0335C2A8R0CA01#
				±0.5pF	GRM0335C2A8R0DA01#
			8.1pF	±0.05pF	GRM0335C2A8R1WA01#
				±0.1pF	GRM0335C2A8R1BA01#
				±0.25pF	GRM0335C2A8R1CA01#
				±0.5pF	GRM0335C2A8R1DA01#
			8.2pF	±0.05pF	GRM0335C2A8R2WA01#
				±0.1pF	GRM0335C2A8R2BA01#
				±0.25pF	GRM0335C2A8R2CA01#
				±0.5pF	GRM0335C2A8R2DA01#
			8.3pF	±0.05pF	GRM0335C2A8R3WA01#
				±0.1pF	GRM0335C2A8R3BA01#
				±0.25pF	GRM0335C2A8R3CA01#
				±0.5pF	GRM0335C2A8R3DA01#
			8.4pF	±0.05pF	GRM0335C2A8R4WA01#
				±0.1pF	GRM0335C2A8R4BA01#
				±0.25pF	GRM0335C2A8R4CA01#
				±0.5pF	GRM0335C2A8R4DA01#
			8.5pF	±0.05pF	GRM0335C2A8R5WA01#
				±0.1pF	GRM0335C2A8R5BA01#
				±0.25pF	GRM0335C2A8R5CA01#
				±0.5pF	GRM0335C2A8R5DA01#
			8.6pF	±0.05pF	GRM0335C2A8R6WA01#
				±0.1pF	GRM0335C2A8R6BA01#
				±0.25pF	GRM0335C2A8R6CA01#
				±0.5pF	GRM0335C2A8R6DA01#
			8.7pF	±0.05pF	GRM0335C2A8R7WA01#
				±0.1pF	GRM0335C2A8R7BA01#
				±0.25pF	GRM0335C2A8R7CA01#
				±0.5pF	GRM0335C2A8R7DA01#
			8.8pF	±0.05pF	GRM0335C2A8R8WA01#
				±0.1pF	GRM0335C2A8R8BA01#
				±0.25pF	GRM0335C2A8R8CA01#
				±0.5pF	GRM0335C2A8R8DA01#
			8.9pF	±0.05pF	GRM0335C2A8R9WA01#
				±0.1pF	GRM0335C2A8R9BA01#
				±0.25pF	GRM0335C2A8R9CA01#
				±0.5pF	GRM0335C2A8R9DA01#
			9.0pF	±0.05pF	GRM0335C2A9R0WA01#
				±0.1pF	GRM0335C2A9R0BA01#
				±0.25pF	GRM0335C2A9R0CA01#
				±0.5pF	GRM0335C2A9R0DA01#
			9.1pF	±0.05pF	GRM0335C2A9R1WA01#
				±0.1pF	GRM0335C2A9R1BA01#
				±0.25pF	GRM0335C2A9R1CA01#
				±0.5pF	GRM0335C2A9R1DA01#
9.2pF	±0.05pF	GRM0335C2A9R2WA01#			
	±0.1pF	GRM0335C2A9R2BA01#			
	±0.25pF	GRM0335C2A9R2CA01#			
	±0.5pF	GRM0335C2A9R2DA01#			
9.3pF	±0.05pF	GRM0335C2A9R3WA01#			
	±0.1pF	GRM0335C2A9R3BA01#			

T寸法 最大値	定格 電圧	温度 特性	静電容量	許容差	品番
0.33mm	100Vdc	C0G	9.3pF	±0.25pF	GRM0335C2A9R3CA01#
				±0.5pF	GRM0335C2A9R3DA01#
			9.4pF	±0.05pF	GRM0335C2A9R4WA01#
				±0.1pF	GRM0335C2A9R4BA01#
				±0.25pF	GRM0335C2A9R4CA01#
			9.5pF	±0.05pF	GRM0335C2A9R5WA01#
				±0.1pF	GRM0335C2A9R5BA01#
				±0.25pF	GRM0335C2A9R5CA01#
			9.6pF	±0.05pF	GRM0335C2A9R6WA01#
				±0.1pF	GRM0335C2A9R6BA01#
				±0.25pF	GRM0335C2A9R6CA01#
			9.7pF	±0.05pF	GRM0335C2A9R7WA01#
				±0.1pF	GRM0335C2A9R7BA01#
				±0.25pF	GRM0335C2A9R7CA01#
			9.8pF	±0.05pF	GRM0335C2A9R8WA01#
				±0.1pF	GRM0335C2A9R8BA01#
				±0.25pF	GRM0335C2A9R8CA01#
			9.9pF	±0.05pF	GRM0335C2A9R9WA01#
				±0.1pF	GRM0335C2A9R9BA01#
				±0.25pF	GRM0335C2A9R9CA01#
			10pF	±2%	GRM0335C2A100GA01#
				±5%	GRM0335C2A100JA01#
			12pF	±2%	GRM0335C2A120GA01#
				±5%	GRM0335C2A120JA01#
	15pF	±2%	GRM0335C2A150GA01#		
		±5%	GRM0335C2A150JA01#		
	50Vdc	CK	0.10pF	±0.05pF	GRM0334C1HR10WA01#
				±0.05pF	GRM0334C1HR20WA01#
			0.20pF	±0.05pF	GRM0334C1HR20BA01#
				±0.1pF	GRM0334C1HR20CA01#
			0.30pF	±0.05pF	GRM0334C1HR30WA01#
				±0.1pF	GRM0334C1HR30BA01#
			0.40pF	±0.05pF	GRM0334C1HR40WA01#
				±0.1pF	GRM0334C1HR40BA01#
			0.50pF	±0.05pF	GRM0334C1HR50WA01#
				±0.1pF	GRM0334C1HR50BA01#
			0.60pF	±0.05pF	GRM0334C1HR60WA01#
				±0.1pF	GRM0334C1HR60BA01#
			0.70pF	±0.05pF	GRM0334C1HR70WA01#
				±0.1pF	GRM0334C1HR70BA01#
			0.80pF	±0.05pF	GRM0334C1HR80WA01#
				±0.1pF	GRM0334C1HR80BA01#
			0.90pF	±0.05pF	GRM0334C1HR90WA01#
				±0.1pF	GRM0334C1HR90BA01#
			1.0pF	±0.05pF	GRM0334C1H1R0WA01#
				±0.1pF	GRM0334C1H1R0BA01#
				±0.25pF	GRM0334C1H1R0CA01#
				±0.05pF	GRM0334C1H1R1WA01#
1.1pF			±0.05pF	GRM0334C1H1R1BA01#	
			±0.1pF	GRM0334C1H1R1CA01#	

品番 #には包装仕様コードが入ります。

GRMシリーズ
 GJMシリーズ
 GMAシリーズ
 GMDシリーズ
 GQMシリーズ
 GRJシリーズ
 GR3シリーズ
 KRMシリーズ
 KR3シリーズ
 LLAシリーズ
 LLLシリーズ
 LLMシリーズ
 LLRシリーズ
 △注意/
 使用上の注意

GRMシリーズ 温度補償用 品番表

(→ ■0.6×0.3mm)

T寸法 最大値	定格 電圧	温度 特性	静電容量	許容差	品番
0.33mm	50Vdc	CK	1.1pF	±0.25pF	GRM0334C1H1R1CA01#
				±0.05pF	GRM0334C1H1R2WA01#
				±0.1pF	GRM0334C1H1R2BA01#
			1.2pF	±0.25pF	GRM0334C1H1R2CA01#
				±0.05pF	GRM0334C1H1R3WA01#
				±0.1pF	GRM0334C1H1R3BA01#
			1.3pF	±0.25pF	GRM0334C1H1R3CA01#
				±0.05pF	GRM0334C1H1R4WA01#
				±0.1pF	GRM0334C1H1R4BA01#
			1.4pF	±0.25pF	GRM0334C1H1R4CA01#
				±0.05pF	GRM0334C1H1R5WA01#
				±0.1pF	GRM0334C1H1R5BA01#
			1.5pF	±0.25pF	GRM0334C1H1R5CA01#
				±0.05pF	GRM0334C1H1R6WA01#
				±0.1pF	GRM0334C1H1R6BA01#
			1.6pF	±0.25pF	GRM0334C1H1R6CA01#
				±0.05pF	GRM0334C1H1R7WA01#
				±0.1pF	GRM0334C1H1R7BA01#
			1.7pF	±0.25pF	GRM0334C1H1R7CA01#
				±0.05pF	GRM0334C1H1R8WA01#
				±0.1pF	GRM0334C1H1R8BA01#
			1.8pF	±0.25pF	GRM0334C1H1R8CA01#
				±0.05pF	GRM0334C1H1R9WA01#
				±0.1pF	GRM0334C1H1R9BA01#
		1.9pF	±0.25pF	GRM0334C1H1R9CA01#	
			±0.05pF	GRM0334C1H2R0WA01#	
			±0.1pF	GRM0334C1H2R0BA01#	
		2.0pF	±0.25pF	GRM0334C1H2R0CA01#	
			2.1pF	±0.05pF	GRM0333C1H2R1WA01#
				±0.1pF	GRM0333C1H2R1BA01#
		±0.25pF		GRM0333C1H2R1CA01#	
		2.2pF	±0.05pF	GRM0333C1H2R2WA01#	
			±0.1pF	GRM0333C1H2R2BA01#	
			±0.25pF	GRM0333C1H2R2CA01#	
		2.3pF	±0.05pF	GRM0333C1H2R3WA01#	
			±0.1pF	GRM0333C1H2R3BA01#	
			±0.25pF	GRM0333C1H2R3CA01#	
		2.4pF	±0.05pF	GRM0333C1H2R4WA01#	
			±0.1pF	GRM0333C1H2R4BA01#	
			±0.25pF	GRM0333C1H2R4CA01#	
		2.5pF	±0.05pF	GRM0333C1H2R5WA01#	
			±0.1pF	GRM0333C1H2R5BA01#	
			±0.25pF	GRM0333C1H2R5CA01#	
		2.6pF	±0.05pF	GRM0333C1H2R6WA01#	
			±0.1pF	GRM0333C1H2R6BA01#	
			±0.25pF	GRM0333C1H2R6CA01#	
		2.7pF	±0.05pF	GRM0333C1H2R7WA01#	
			±0.1pF	GRM0333C1H2R7BA01#	
±0.25pF	GRM0333C1H2R7CA01#				
2.8pF	±0.05pF	GRM0333C1H2R8WA01#			
	±0.1pF	GRM0333C1H2R8BA01#			
	±0.25pF	GRM0333C1H2R8CA01#			
2.9pF	±0.05pF	GRM0333C1H2R9WA01#			
	±0.1pF	GRM0333C1H2R9BA01#			

T寸法 最大値	定格 電圧	温度 特性	静電容量	許容差	品番	
0.33mm	50Vdc	CJ	2.9pF	±0.25pF	GRM0333C1H2R9CA01#	
				±0.05pF	GRM0333C1H3R0WA01#	
				±0.1pF	GRM0333C1H3R0BA01#	
			3.0pF	±0.25pF	GRM0333C1H3R0CA01#	
				±0.05pF	GRM0333C1H3R1WA01#	
				±0.1pF	GRM0333C1H3R1BA01#	
			3.1pF	±0.25pF	GRM0333C1H3R1CA01#	
				±0.05pF	GRM0333C1H3R2WA01#	
				±0.1pF	GRM0333C1H3R2BA01#	
			3.2pF	±0.25pF	GRM0333C1H3R2CA01#	
				±0.05pF	GRM0333C1H3R3WA01#	
				±0.1pF	GRM0333C1H3R3BA01#	
			3.3pF	±0.25pF	GRM0333C1H3R3CA01#	
				±0.05pF	GRM0333C1H3R4WA01#	
				±0.1pF	GRM0333C1H3R4BA01#	
			3.4pF	±0.25pF	GRM0333C1H3R4CA01#	
				±0.05pF	GRM0333C1H3R5WA01#	
				±0.1pF	GRM0333C1H3R5BA01#	
			3.5pF	±0.25pF	GRM0333C1H3R5CA01#	
				±0.05pF	GRM0333C1H3R6WA01#	
				±0.1pF	GRM0333C1H3R6BA01#	
			3.6pF	±0.25pF	GRM0333C1H3R6CA01#	
				±0.05pF	GRM0333C1H3R7WA01#	
				±0.1pF	GRM0333C1H3R7BA01#	
		3.7pF	±0.25pF	GRM0333C1H3R7CA01#		
			±0.05pF	GRM0333C1H3R8WA01#		
			±0.1pF	GRM0333C1H3R8BA01#		
		3.8pF	±0.25pF	GRM0333C1H3R8CA01#		
			±0.05pF	GRM0333C1H3R9WA01#		
			±0.1pF	GRM0333C1H3R9BA01#		
		3.9pF	±0.25pF	GRM0333C1H3R9CA01#		
			CH	4.0pF	±0.05pF	GRM0332C1H4R0WA01#
					±0.1pF	GRM0332C1H4R0BA01#
		±0.25pF			GRM0332C1H4R0CA01#	
		4.1pF		±0.05pF	GRM0332C1H4R1WA01#	
				±0.1pF	GRM0332C1H4R1BA01#	
				±0.25pF	GRM0332C1H4R1CA01#	
		4.2pF		±0.05pF	GRM0332C1H4R2WA01#	
				±0.1pF	GRM0332C1H4R2BA01#	
				±0.25pF	GRM0332C1H4R2CA01#	
		4.3pF		±0.05pF	GRM0332C1H4R3WA01#	
				±0.1pF	GRM0332C1H4R3BA01#	
				±0.25pF	GRM0332C1H4R3CA01#	
		4.4pF	±0.05pF	GRM0332C1H4R4WA01#		
			±0.1pF	GRM0332C1H4R4BA01#		
			±0.25pF	GRM0332C1H4R4CA01#		
		4.5pF	±0.05pF	GRM0332C1H4R5WA01#		
			±0.1pF	GRM0332C1H4R5BA01#		
±0.25pF	GRM0332C1H4R5CA01#					
4.6pF	±0.05pF	GRM0332C1H4R6WA01#				
	±0.1pF	GRM0332C1H4R6BA01#				
	±0.25pF	GRM0332C1H4R6CA01#				
4.7pF	±0.05pF	GRM0332C1H4R7WA01#				
	±0.1pF	GRM0332C1H4R7BA01#				

品番 #には包装仕様コードが入ります。

GRMシリーズ
GJMシリーズ
GMAシリーズ
GMDシリーズ
GQMシリーズ
GRJシリーズ
GRSシリーズ
KRMシリーズ
KRSシリーズ
LLAシリーズ
LLLシリーズ
LLMシリーズ
LLRシリーズ
△注意/
使用上の注意

GRMシリーズ 温度補償用 品番表

(→ ■0.6×0.3mm)

T寸法 最大値	定格 電圧	温度 特性	静電容量	許容差	品番
0.33mm	50Vdc	CH	4.7pF	±0.25pF	GRM0332C1H4R7CA01#
				±0.05pF	GRM0332C1H4R8WA01#
					±0.1pF
			±0.25pF		GRM0332C1H4R8CA01#
			4.9pF	±0.05pF	GRM0332C1H4R9WA01#
				±0.1pF	GRM0332C1H4R9BA01#
				±0.25pF	GRM0332C1H4R9CA01#
			5.0pF	±0.05pF	GRM0332C1H5R0WA01#
				±0.1pF	GRM0332C1H5R0BA01#
				±0.25pF	GRM0332C1H5R0CA01#
			5.1pF	±0.05pF	GRM0332C1H5R1WA01#
				±0.1pF	GRM0332C1H5R1BA01#
				±0.25pF	GRM0332C1H5R1CA01#
			5.2pF	±0.05pF	GRM0332C1H5R2WA01#
				±0.1pF	GRM0332C1H5R2BA01#
				±0.25pF	GRM0332C1H5R2CA01#
			5.3pF	±0.05pF	GRM0332C1H5R3WA01#
				±0.1pF	GRM0332C1H5R3BA01#
				±0.25pF	GRM0332C1H5R3CA01#
			5.4pF	±0.05pF	GRM0332C1H5R4WA01#
				±0.1pF	GRM0332C1H5R4BA01#
				±0.25pF	GRM0332C1H5R4CA01#
			5.5pF	±0.05pF	GRM0332C1H5R5WA01#
				±0.1pF	GRM0332C1H5R5BA01#
				±0.25pF	GRM0332C1H5R5CA01#
			5.6pF	±0.05pF	GRM0332C1H5R6WA01#
				±0.1pF	GRM0332C1H5R6BA01#
				±0.25pF	GRM0332C1H5R6CA01#
			5.7pF	±0.05pF	GRM0332C1H5R7WA01#
				±0.1pF	GRM0332C1H5R7BA01#
				±0.25pF	GRM0332C1H5R7CA01#
			5.8pF	±0.05pF	GRM0332C1H5R8WA01#
				±0.1pF	GRM0332C1H5R8BA01#
				±0.25pF	GRM0332C1H5R8CA01#
			5.9pF	±0.05pF	GRM0332C1H5R9WA01#
				±0.1pF	GRM0332C1H5R9BA01#
				±0.25pF	GRM0332C1H5R9CA01#
			6.0pF	±0.05pF	GRM0332C1H6R0WA01#
				±0.1pF	GRM0332C1H6R0BA01#
				±0.25pF	GRM0332C1H6R0CA01#
			6.1pF	±0.05pF	GRM0332C1H6R1WA01#
				±0.1pF	GRM0332C1H6R1BA01#
				±0.25pF	GRM0332C1H6R1CA01#
			6.2pF	±0.05pF	GRM0332C1H6R2WA01#
				±0.1pF	GRM0332C1H6R2BA01#
				±0.25pF	GRM0332C1H6R2CA01#
			6.3pF	±0.05pF	GRM0332C1H6R3WA01#
				±0.1pF	GRM0332C1H6R3BA01#
±0.25pF	GRM0332C1H6R3CA01#				
6.4pF	±0.05pF	GRM0332C1H6R4WA01#			
	±0.1pF	GRM0332C1H6R4BA01#			
	±0.25pF	GRM0332C1H6R4CA01#			
6.5pF	±0.05pF	GRM0332C1H6R5WA01#			
	±0.1pF	GRM0332C1H6R5BA01#			
	±0.25pF	GRM0332C1H6R5CA01#			
6.6pF	±0.05pF	GRM0332C1H6R6WA01#			
	±0.1pF	GRM0332C1H6R6BA01#			
	±0.25pF	GRM0332C1H6R6CA01#			
6.7pF	±0.05pF	GRM0332C1H6R7WA01#			
	±0.1pF	GRM0332C1H6R7BA01#			
	±0.25pF	GRM0332C1H6R7CA01#			
6.8pF	±0.05pF	GRM0332C1H6R8WA01#			
	±0.1pF	GRM0332C1H6R8BA01#			
	±0.25pF	GRM0332C1H6R8CA01#			
6.9pF	±0.05pF	GRM0332C1H6R9WA01#			
	±0.1pF	GRM0332C1H6R9BA01#			
	±0.25pF	GRM0332C1H6R9CA01#			
7.0pF	±0.05pF	GRM0332C1H7R0WA01#			
	±0.1pF	GRM0332C1H7R0BA01#			
	±0.25pF	GRM0332C1H7R0CA01#			
7.1pF	±0.05pF	GRM0332C1H7R1WA01#			
	±0.1pF	GRM0332C1H7R1BA01#			
	±0.25pF	GRM0332C1H7R1CA01#			
7.2pF	±0.05pF	GRM0332C1H7R2WA01#			
	±0.1pF	GRM0332C1H7R2BA01#			
	±0.25pF	GRM0332C1H7R2CA01#			
7.3pF	±0.05pF	GRM0332C1H7R3WA01#			
	±0.1pF	GRM0332C1H7R3BA01#			
	±0.25pF	GRM0332C1H7R3CA01#			
7.4pF	±0.05pF	GRM0332C1H7R4WA01#			
	±0.1pF	GRM0332C1H7R4BA01#			
	±0.25pF	GRM0332C1H7R4CA01#			
7.5pF	±0.05pF	GRM0332C1H7R5WA01#			
	±0.1pF	GRM0332C1H7R5BA01#			
	±0.25pF	GRM0332C1H7R5CA01#			

T寸法 最大値	定格 電圧	温度 特性	静電容量	許容差	品番
0.33mm	50Vdc	CH	6.2pF	±0.05pF	GRM0332C1H6R2WA01#
				±0.1pF	GRM0332C1H6R2BA01#
				±0.25pF	GRM0332C1H6R2CA01#
			6.3pF	±0.05pF	GRM0332C1H6R3WA01#
				±0.1pF	GRM0332C1H6R3BA01#
				±0.25pF	GRM0332C1H6R3CA01#
			6.4pF	±0.05pF	GRM0332C1H6R4WA01#
				±0.1pF	GRM0332C1H6R4BA01#
				±0.25pF	GRM0332C1H6R4CA01#
			6.5pF	±0.05pF	GRM0332C1H6R5WA01#
				±0.1pF	GRM0332C1H6R5BA01#
				±0.25pF	GRM0332C1H6R5CA01#
			6.6pF	±0.05pF	GRM0332C1H6R6WA01#
				±0.1pF	GRM0332C1H6R6BA01#
				±0.25pF	GRM0332C1H6R6CA01#
			6.7pF	±0.05pF	GRM0332C1H6R7WA01#
				±0.1pF	GRM0332C1H6R7BA01#
				±0.25pF	GRM0332C1H6R7CA01#
			6.8pF	±0.05pF	GRM0332C1H6R8WA01#
				±0.1pF	GRM0332C1H6R8BA01#
				±0.25pF	GRM0332C1H6R8CA01#
			6.9pF	±0.05pF	GRM0332C1H6R9WA01#
				±0.1pF	GRM0332C1H6R9BA01#
				±0.25pF	GRM0332C1H6R9CA01#
			7.0pF	±0.05pF	GRM0332C1H7R0WA01#
				±0.1pF	GRM0332C1H7R0BA01#
				±0.25pF	GRM0332C1H7R0CA01#
			7.1pF	±0.05pF	GRM0332C1H7R1WA01#
				±0.1pF	GRM0332C1H7R1BA01#
				±0.25pF	GRM0332C1H7R1CA01#
			7.2pF	±0.05pF	GRM0332C1H7R2WA01#
				±0.1pF	GRM0332C1H7R2BA01#
				±0.25pF	GRM0332C1H7R2CA01#
			7.3pF	±0.05pF	GRM0332C1H7R3WA01#
				±0.1pF	GRM0332C1H7R3BA01#
				±0.25pF	GRM0332C1H7R3CA01#
			7.4pF	±0.05pF	GRM0332C1H7R4WA01#
				±0.1pF	GRM0332C1H7R4BA01#
				±0.25pF	GRM0332C1H7R4CA01#
			7.5pF	±0.05pF	GRM0332C1H7R5WA01#
				±0.1pF	GRM0332C1H7R5BA01#
				±0.25pF	GRM0332C1H7R5CA01#

品番 #には包装仕様コードが入ります。

GRMシリーズ
 GJMシリーズ
 GMAシリーズ
 GMDシリーズ
 GQMシリーズ
 GRJシリーズ
 GR3シリーズ
 KRMシリーズ
 KR3シリーズ
 LLAシリーズ
 LLLシリーズ
 LLMシリーズ
 LLRシリーズ
 △注意/
 使用上の注意

GRMシリーズ 温度補償用 品番表

(→ ■0.6×0.3mm)

T寸法 最大値	定格 電圧	温度 特性	静電容量	許容差	品番
0.33mm	50Vdc	CH	7.5pF	±0.25pF	GRM0332C1H7R5CA01#
				±0.5pF	GRM0332C1H7R5DA01#
			7.6pF	±0.05pF	GRM0332C1H7R6WA01#
				±0.1pF	GRM0332C1H7R6BA01#
				±0.25pF	GRM0332C1H7R6CA01#
				±0.5pF	GRM0332C1H7R6DA01#
			7.7pF	±0.05pF	GRM0332C1H7R7WA01#
				±0.1pF	GRM0332C1H7R7BA01#
				±0.25pF	GRM0332C1H7R7CA01#
				±0.5pF	GRM0332C1H7R7DA01#
			7.8pF	±0.05pF	GRM0332C1H7R8WA01#
				±0.1pF	GRM0332C1H7R8BA01#
				±0.25pF	GRM0332C1H7R8CA01#
				±0.5pF	GRM0332C1H7R8DA01#
			7.9pF	±0.05pF	GRM0332C1H7R9WA01#
				±0.1pF	GRM0332C1H7R9BA01#
				±0.25pF	GRM0332C1H7R9CA01#
				±0.5pF	GRM0332C1H7R9DA01#
			8.0pF	±0.05pF	GRM0332C1H8R0WA01#
				±0.1pF	GRM0332C1H8R0BA01#
				±0.25pF	GRM0332C1H8R0CA01#
				±0.5pF	GRM0332C1H8R0DA01#
			8.1pF	±0.05pF	GRM0332C1H8R1WA01#
				±0.1pF	GRM0332C1H8R1BA01#
				±0.25pF	GRM0332C1H8R1CA01#
				±0.5pF	GRM0332C1H8R1DA01#
			8.2pF	±0.05pF	GRM0332C1H8R2WA01#
				±0.1pF	GRM0332C1H8R2BA01#
				±0.25pF	GRM0332C1H8R2CA01#
				±0.5pF	GRM0332C1H8R2DA01#
			8.3pF	±0.05pF	GRM0332C1H8R3WA01#
				±0.1pF	GRM0332C1H8R3BA01#
				±0.25pF	GRM0332C1H8R3CA01#
				±0.5pF	GRM0332C1H8R3DA01#
			8.4pF	±0.05pF	GRM0332C1H8R4WA01#
				±0.1pF	GRM0332C1H8R4BA01#
				±0.25pF	GRM0332C1H8R4CA01#
				±0.5pF	GRM0332C1H8R4DA01#
			8.5pF	±0.05pF	GRM0332C1H8R5WA01#
				±0.1pF	GRM0332C1H8R5BA01#
				±0.25pF	GRM0332C1H8R5CA01#
				±0.5pF	GRM0332C1H8R5DA01#
			8.6pF	±0.05pF	GRM0332C1H8R6WA01#
				±0.1pF	GRM0332C1H8R6BA01#
				±0.25pF	GRM0332C1H8R6CA01#
				±0.5pF	GRM0332C1H8R6DA01#
			8.7pF	±0.05pF	GRM0332C1H8R7WA01#
				±0.1pF	GRM0332C1H8R7BA01#
±0.25pF	GRM0332C1H8R7CA01#				
±0.5pF	GRM0332C1H8R7DA01#				
8.8pF	±0.05pF	GRM0332C1H8R8WA01#			
	±0.1pF	GRM0332C1H8R8BA01#			
	±0.25pF	GRM0332C1H8R8CA01#			
	±0.5pF	GRM0332C1H8R8DA01#			

T寸法 最大値	定格 電圧	温度 特性	静電容量	許容差	品番
0.33mm	50Vdc	CH	8.9pF	±0.05pF	GRM0332C1H8R9WA01#
				±0.1pF	GRM0332C1H8R9BA01#
				±0.25pF	GRM0332C1H8R9CA01#
				±0.5pF	GRM0332C1H8R9DA01#
			9.0pF	±0.05pF	GRM0332C1H9R0WA01#
				±0.1pF	GRM0332C1H9R0BA01#
				±0.25pF	GRM0332C1H9R0CA01#
				±0.5pF	GRM0332C1H9R0DA01#
			9.1pF	±0.05pF	GRM0332C1H9R1WA01#
				±0.1pF	GRM0332C1H9R1BA01#
				±0.25pF	GRM0332C1H9R1CA01#
				±0.5pF	GRM0332C1H9R1DA01#
			9.2pF	±0.05pF	GRM0332C1H9R2WA01#
				±0.1pF	GRM0332C1H9R2BA01#
				±0.25pF	GRM0332C1H9R2CA01#
				±0.5pF	GRM0332C1H9R2DA01#
			9.3pF	±0.05pF	GRM0332C1H9R3WA01#
				±0.1pF	GRM0332C1H9R3BA01#
				±0.25pF	GRM0332C1H9R3CA01#
				±0.5pF	GRM0332C1H9R3DA01#
			9.4pF	±0.05pF	GRM0332C1H9R4WA01#
				±0.1pF	GRM0332C1H9R4BA01#
				±0.25pF	GRM0332C1H9R4CA01#
				±0.5pF	GRM0332C1H9R4DA01#
			9.5pF	±0.05pF	GRM0332C1H9R5WA01#
				±0.1pF	GRM0332C1H9R5BA01#
				±0.25pF	GRM0332C1H9R5CA01#
				±0.5pF	GRM0332C1H9R5DA01#
			9.6pF	±0.05pF	GRM0332C1H9R6WA01#
				±0.1pF	GRM0332C1H9R6BA01#
				±0.25pF	GRM0332C1H9R6CA01#
				±0.5pF	GRM0332C1H9R6DA01#
			9.7pF	±0.05pF	GRM0332C1H9R7WA01#
				±0.1pF	GRM0332C1H9R7BA01#
				±0.25pF	GRM0332C1H9R7CA01#
				±0.5pF	GRM0332C1H9R7DA01#
			9.8pF	±0.05pF	GRM0332C1H9R8WA01#
				±0.1pF	GRM0332C1H9R8BA01#
				±0.25pF	GRM0332C1H9R8CA01#
				±0.5pF	GRM0332C1H9R8DA01#
			9.9pF	±0.05pF	GRM0332C1H9R9WA01#
				±0.1pF	GRM0332C1H9R9BA01#
				±0.25pF	GRM0332C1H9R9CA01#
				±0.5pF	GRM0332C1H9R9DA01#
			10pF	±2%	GRM0332C1H100GA01#
				±5%	GRM0332C1H100JA01#
			12pF	±2%	GRM0332C1H120GA01#
				±5%	GRM0332C1H120JA01#
15pF	±2%	GRM0332C1H150GA01#			
	±5%	GRM0332C1H150JA01#			
18pF	±2%	GRM0332C1H180GA01#			
	±5%	GRM0332C1H180JA01#			
22pF	±2%	GRM0332C1H220GA01#			
	±5%	GRM0332C1H220JA01#			

品番 #には包装仕様コードが入ります。

GRMシリーズ
GJMシリーズ
GMAシリーズ
GMDシリーズ
GQMシリーズ
GRJシリーズ
GR3シリーズ
KRMシリーズ
KR3シリーズ
LLAシリーズ
LLLシリーズ
LLMシリーズ
LLRシリーズ
△注意/
使用上の注意

GRMシリーズ 温度補償用 品番表

(→ ■0.6×0.3mm)

T寸法 最大値	定格 電圧	温度 特性	静電容量	許容差	品番	
0.33mm	50Vdc	CH	27pF	±2%	GRM0332C1H270GA01#	
				±5%	GRM0332C1H270JA01#	
			33pF	±2%	GRM0332C1H330GA01#	
				±5%	GRM0332C1H330JA01#	
			39pF	±2%	GRM0332C1H390GA01#	
				±5%	GRM0332C1H390JA01#	
			47pF	±2%	GRM0332C1H470GA01#	
				±5%	GRM0332C1H470JA01#	
			56pF	±2%	GRM0332C1H560GA01#	
				±5%	GRM0332C1H560JA01#	
			68pF	±2%	GRM0332C1H680GA01#	
				±5%	GRM0332C1H680JA01#	
			82pF	±2%	GRM0332C1H820GA01#	
				±5%	GRM0332C1H820JA01#	
			100pF	±2%	GRM0332C1H101GA01#	
				±5%	GRM0332C1H101JA01#	
			120pF	±2%	GRM0332C1H121GA01#	
				±5%	GRM0332C1H121JA01#	
			150pF	±2%	GRM0332C1H151GA01#	
				±5%	GRM0332C1H151JA01#	
			180pF	±2%	GRM0332C1H181GA01#	
				±5%	GRM0332C1H181JA01#	
			220pF	±2%	GRM0332C1H221GA01#	
				±5%	GRM0332C1H221JA01#	
		COG		0.10pF	±0.05pF	GRM0335C1HR10WA01#
					±0.1pF	GRM0335C1HR10BA01#
				0.20pF	±0.05pF	GRM0335C1HR20WA01#
					±0.1pF	GRM0335C1HR20BA01#
				0.30pF	±0.05pF	GRM0335C1HR30WA01#
					±0.1pF	GRM0335C1HR30BA01#
				0.40pF	±0.05pF	GRM0335C1HR40WA01#
					±0.1pF	GRM0335C1HR40BA01#
				0.50pF	±0.05pF	GRM0335C1HR50WA01#
					±0.1pF	GRM0335C1HR50BA01#
				0.60pF	±0.05pF	GRM0335C1HR60WA01#
					±0.1pF	GRM0335C1HR60BA01#
				0.70pF	±0.05pF	GRM0335C1HR70WA01#
					±0.1pF	GRM0335C1HR70BA01#
				0.80pF	±0.05pF	GRM0335C1HR80WA01#
					±0.1pF	GRM0335C1HR80BA01#
				0.90pF	±0.05pF	GRM0335C1HR90WA01#
					±0.1pF	GRM0335C1HR90BA01#
				1.0pF	±0.05pF	GRM0335C1H1R0WA01#
					±0.1pF	GRM0335C1H1R0BA01#
					±0.25pF	GRM0335C1H1R0CA01#
				1.1pF	±0.05pF	GRM0335C1H1R1WA01#
					±0.1pF	GRM0335C1H1R1BA01#
					±0.25pF	GRM0335C1H1R1CA01#
1.2pF	±0.05pF	GRM0335C1H1R2WA01#				
	±0.1pF	GRM0335C1H1R2BA01#				
	±0.25pF	GRM0335C1H1R2CA01#				
1.3pF	±0.05pF	GRM0335C1H1R3WA01#				
	±0.1pF	GRM0335C1H1R3BA01#				
	±0.25pF	GRM0335C1H1R3CA01#				
1.4pF	±0.05pF	GRM0335C1H1R4WA01#				

T寸法 最大値	定格 電圧	温度 特性	静電容量	許容差	品番
0.33mm	50Vdc	COG	1.4pF	±0.1pF	GRM0335C1H1R4BA01#
				±0.25pF	GRM0335C1H1R4CA01#
			1.5pF	±0.05pF	GRM0335C1H1R5WA01#
				±0.1pF	GRM0335C1H1R5BA01#
				±0.25pF	GRM0335C1H1R5CA01#
				1.6pF	±0.05pF
			±0.1pF		GRM0335C1H1R6BA01#
			±0.25pF		GRM0335C1H1R6CA01#
			1.7pF	±0.05pF	GRM0335C1H1R7WA01#
				±0.1pF	GRM0335C1H1R7BA01#
				±0.25pF	GRM0335C1H1R7CA01#
			1.8pF	±0.05pF	GRM0335C1H1R8WA01#
				±0.1pF	GRM0335C1H1R8BA01#
				±0.25pF	GRM0335C1H1R8CA01#
			1.9pF	±0.05pF	GRM0335C1H1R9WA01#
				±0.1pF	GRM0335C1H1R9BA01#
				±0.25pF	GRM0335C1H1R9CA01#
			2.0pF	±0.05pF	GRM0335C1H2R0WA01#
				±0.1pF	GRM0335C1H2R0BA01#
				±0.25pF	GRM0335C1H2R0CA01#
			2.1pF	±0.05pF	GRM0335C1H2R1WA01#
				±0.1pF	GRM0335C1H2R1BA01#
				±0.25pF	GRM0335C1H2R1CA01#
			2.2pF	±0.05pF	GRM0335C1H2R2WA01#
				±0.1pF	GRM0335C1H2R2BA01#
				±0.25pF	GRM0335C1H2R2CA01#
			2.3pF	±0.05pF	GRM0335C1H2R3WA01#
				±0.1pF	GRM0335C1H2R3BA01#
				±0.25pF	GRM0335C1H2R3CA01#
			2.4pF	±0.05pF	GRM0335C1H2R4WA01#
				±0.1pF	GRM0335C1H2R4BA01#
				±0.25pF	GRM0335C1H2R4CA01#
			2.5pF	±0.05pF	GRM0335C1H2R5WA01#
				±0.1pF	GRM0335C1H2R5BA01#
				±0.25pF	GRM0335C1H2R5CA01#
			2.6pF	±0.05pF	GRM0335C1H2R6WA01#
				±0.1pF	GRM0335C1H2R6BA01#
				±0.25pF	GRM0335C1H2R6CA01#
			2.7pF	±0.05pF	GRM0335C1H2R7WA01#
				±0.1pF	GRM0335C1H2R7BA01#
				±0.25pF	GRM0335C1H2R7CA01#
			2.8pF	±0.05pF	GRM0335C1H2R8WA01#
				±0.1pF	GRM0335C1H2R8BA01#
				±0.25pF	GRM0335C1H2R8CA01#
			2.9pF	±0.05pF	GRM0335C1H2R9WA01#
				±0.1pF	GRM0335C1H2R9BA01#
				±0.25pF	GRM0335C1H2R9CA01#
			3.0pF	±0.05pF	GRM0335C1H3R0WA01#
±0.1pF	GRM0335C1H3R0BA01#				
±0.25pF	GRM0335C1H3R0CA01#				
±0.25pF	GRM0335C1H3R0CA01#				
3.1pF	±0.05pF	GRM0335C1H3R1WA01#			
	±0.1pF	GRM0335C1H3R1BA01#			
	±0.25pF	GRM0335C1H3R1CA01#			
3.2pF	±0.05pF	GRM0335C1H3R2WA01#			

品番 #には包装仕様コードが入ります。

GRMシリーズ
 GJMシリーズ
 GMAシリーズ
 GMDシリーズ
 GQMシリーズ
 GRJシリーズ
 GR3シリーズ
 KRMシリーズ
 KR3シリーズ
 LLAシリーズ
 LLLシリーズ
 LLMシリーズ
 LLRシリーズ
 △注意/
 使用上の注意

GRMシリーズ 温度補償用 品番表

(→ ■0.6×0.3mm)

T寸法 最大値	定格 電圧	温度 特性	静電容量	許容差	品番
0.33mm	50Vdc	C0G	3.2pF	±0.1pF	GRM0335C1H3R2BA01#
				±0.25pF	GRM0335C1H3R2CA01#
			3.3pF	±0.05pF	GRM0335C1H3R3WA01#
				±0.1pF	GRM0335C1H3R3BA01#
			3.4pF	±0.05pF	GRM0335C1H3R4WA01#
				±0.1pF	GRM0335C1H3R4BA01#
			3.5pF	±0.05pF	GRM0335C1H3R5WA01#
				±0.1pF	GRM0335C1H3R5BA01#
			3.6pF	±0.05pF	GRM0335C1H3R6WA01#
				±0.1pF	GRM0335C1H3R6BA01#
			3.7pF	±0.05pF	GRM0335C1H3R7WA01#
				±0.1pF	GRM0335C1H3R7BA01#
			3.8pF	±0.05pF	GRM0335C1H3R8WA01#
				±0.1pF	GRM0335C1H3R8BA01#
			3.9pF	±0.05pF	GRM0335C1H3R9WA01#
				±0.1pF	GRM0335C1H3R9BA01#
			4.0pF	±0.05pF	GRM0335C1H4R0WA01#
				±0.1pF	GRM0335C1H4R0BA01#
			4.1pF	±0.05pF	GRM0335C1H4R1WA01#
				±0.1pF	GRM0335C1H4R1BA01#
			4.2pF	±0.05pF	GRM0335C1H4R2WA01#
				±0.1pF	GRM0335C1H4R2BA01#
			4.3pF	±0.05pF	GRM0335C1H4R3WA01#
				±0.1pF	GRM0335C1H4R3BA01#
			4.4pF	±0.05pF	GRM0335C1H4R4WA01#
				±0.1pF	GRM0335C1H4R4BA01#
			4.5pF	±0.05pF	GRM0335C1H4R5WA01#
				±0.1pF	GRM0335C1H4R5BA01#
			4.6pF	±0.05pF	GRM0335C1H4R6WA01#
				±0.1pF	GRM0335C1H4R6BA01#
			4.7pF	±0.05pF	GRM0335C1H4R7WA01#
				±0.1pF	GRM0335C1H4R7BA01#
			4.8pF	±0.05pF	GRM0335C1H4R8WA01#
				±0.1pF	GRM0335C1H4R8BA01#
			4.9pF	±0.05pF	GRM0335C1H4R9WA01#
				±0.1pF	GRM0335C1H4R9BA01#
			5.0pF	±0.05pF	GRM0335C1H5R0WA01#
				±0.1pF	GRM0335C1H5R0BA01#

T寸法 最大値	定格 電圧	温度 特性	静電容量	許容差	品番
0.33mm	50Vdc	C0G	5.0pF	±0.1pF	GRM0335C1H5R0BA01#
				±0.25pF	GRM0335C1H5R0CA01#
			5.1pF	±0.05pF	GRM0335C1H5R1WA01#
				±0.1pF	GRM0335C1H5R1BA01#
			5.2pF	±0.05pF	GRM0335C1H5R2WA01#
				±0.1pF	GRM0335C1H5R2BA01#
			5.3pF	±0.05pF	GRM0335C1H5R3WA01#
				±0.1pF	GRM0335C1H5R3BA01#
			5.4pF	±0.05pF	GRM0335C1H5R4WA01#
				±0.1pF	GRM0335C1H5R4BA01#
			5.5pF	±0.05pF	GRM0335C1H5R5WA01#
				±0.1pF	GRM0335C1H5R5BA01#
			5.6pF	±0.05pF	GRM0335C1H5R6WA01#
				±0.1pF	GRM0335C1H5R6BA01#
			5.7pF	±0.05pF	GRM0335C1H5R7WA01#
				±0.1pF	GRM0335C1H5R7BA01#
			5.8pF	±0.05pF	GRM0335C1H5R8WA01#
				±0.1pF	GRM0335C1H5R8BA01#
			5.9pF	±0.05pF	GRM0335C1H5R9WA01#
				±0.1pF	GRM0335C1H5R9BA01#
			6.0pF	±0.05pF	GRM0335C1H6R0WA01#
				±0.1pF	GRM0335C1H6R0BA01#
			6.1pF	±0.05pF	GRM0335C1H6R1WA01#
				±0.1pF	GRM0335C1H6R1BA01#
			6.2pF	±0.05pF	GRM0335C1H6R2WA01#
				±0.1pF	GRM0335C1H6R2BA01#
			6.3pF	±0.05pF	GRM0335C1H6R3WA01#
				±0.1pF	GRM0335C1H6R3BA01#

品番 #には包装仕様コードが入ります。

GRMシリーズ
GJMシリーズ
GMAシリーズ
GMDシリーズ
GQMシリーズ
GRJシリーズ
GR3シリーズ
KRMシリーズ
KR3シリーズ
LLAシリーズ
LLLシリーズ
LLMシリーズ
LLRシリーズ
△注意/
使用上の注意

GRMシリーズ 温度補償用 品番表

(→ ■0.6×0.3mm)

T寸法 最大値	定格 電圧	温度 特性	静電容量	許容差	品番
0.33mm	50Vdc	C0G	6.4pF	±0.05pF	GRM0335C1H6R4WA01#
				±0.1pF	GRM0335C1H6R4BA01#
				±0.25pF	GRM0335C1H6R4CA01#
				±0.5pF	GRM0335C1H6R4DA01#
			6.5pF	±0.05pF	GRM0335C1H6R5WA01#
				±0.1pF	GRM0335C1H6R5BA01#
				±0.25pF	GRM0335C1H6R5CA01#
				±0.5pF	GRM0335C1H6R5DA01#
			6.6pF	±0.05pF	GRM0335C1H6R6WA01#
				±0.1pF	GRM0335C1H6R6BA01#
				±0.25pF	GRM0335C1H6R6CA01#
				±0.5pF	GRM0335C1H6R6DA01#
			6.7pF	±0.05pF	GRM0335C1H6R7WA01#
				±0.1pF	GRM0335C1H6R7BA01#
				±0.25pF	GRM0335C1H6R7CA01#
				±0.5pF	GRM0335C1H6R7DA01#
			6.8pF	±0.05pF	GRM0335C1H6R8WA01#
				±0.1pF	GRM0335C1H6R8BA01#
				±0.25pF	GRM0335C1H6R8CA01#
				±0.5pF	GRM0335C1H6R8DA01#
			6.9pF	±0.05pF	GRM0335C1H6R9WA01#
				±0.1pF	GRM0335C1H6R9BA01#
				±0.25pF	GRM0335C1H6R9CA01#
				±0.5pF	GRM0335C1H6R9DA01#
			7.0pF	±0.05pF	GRM0335C1H7R0WA01#
				±0.1pF	GRM0335C1H7R0BA01#
				±0.25pF	GRM0335C1H7R0CA01#
				±0.5pF	GRM0335C1H7R0DA01#
			7.1pF	±0.05pF	GRM0335C1H7R1WA01#
				±0.1pF	GRM0335C1H7R1BA01#
				±0.25pF	GRM0335C1H7R1CA01#
				±0.5pF	GRM0335C1H7R1DA01#
			7.2pF	±0.05pF	GRM0335C1H7R2WA01#
				±0.1pF	GRM0335C1H7R2BA01#
				±0.25pF	GRM0335C1H7R2CA01#
				±0.5pF	GRM0335C1H7R2DA01#
			7.3pF	±0.05pF	GRM0335C1H7R3WA01#
				±0.1pF	GRM0335C1H7R3BA01#
				±0.25pF	GRM0335C1H7R3CA01#
				±0.5pF	GRM0335C1H7R3DA01#
			7.4pF	±0.05pF	GRM0335C1H7R4WA01#
				±0.1pF	GRM0335C1H7R4BA01#
				±0.25pF	GRM0335C1H7R4CA01#
				±0.5pF	GRM0335C1H7R4DA01#
			7.5pF	±0.05pF	GRM0335C1H7R5WA01#
				±0.1pF	GRM0335C1H7R5BA01#
				±0.25pF	GRM0335C1H7R5CA01#
				±0.5pF	GRM0335C1H7R5DA01#
7.6pF	±0.05pF	GRM0335C1H7R6WA01#			
	±0.1pF	GRM0335C1H7R6BA01#			
	±0.25pF	GRM0335C1H7R6CA01#			
	±0.5pF	GRM0335C1H7R6DA01#			
7.7pF	±0.05pF	GRM0335C1H7R7WA01#			
	±0.1pF	GRM0335C1H7R7BA01#			

T寸法 最大値	定格 電圧	温度 特性	静電容量	許容差	品番
0.33mm	50Vdc	C0G	7.7pF	±0.25pF	GRM0335C1H7R7CA01#
				±0.5pF	GRM0335C1H7R7DA01#
			7.8pF	±0.05pF	GRM0335C1H7R8WA01#
				±0.1pF	GRM0335C1H7R8BA01#
				±0.25pF	GRM0335C1H7R8CA01#
			±0.5pF	GRM0335C1H7R8DA01#	
			7.9pF	±0.05pF	GRM0335C1H7R9WA01#
				±0.1pF	GRM0335C1H7R9BA01#
				±0.25pF	GRM0335C1H7R9CA01#
			±0.5pF	GRM0335C1H7R9DA01#	
			8.0pF	±0.05pF	GRM0335C1H8R0WA01#
				±0.1pF	GRM0335C1H8R0BA01#
				±0.25pF	GRM0335C1H8R0CA01#
			±0.5pF	GRM0335C1H8R0DA01#	
			8.1pF	±0.05pF	GRM0335C1H8R1WA01#
				±0.1pF	GRM0335C1H8R1BA01#
				±0.25pF	GRM0335C1H8R1CA01#
			±0.5pF	GRM0335C1H8R1DA01#	
			8.2pF	±0.05pF	GRM0335C1H8R2WA01#
				±0.1pF	GRM0335C1H8R2BA01#
				±0.25pF	GRM0335C1H8R2CA01#
			±0.5pF	GRM0335C1H8R2DA01#	
			8.3pF	±0.05pF	GRM0335C1H8R3WA01#
				±0.1pF	GRM0335C1H8R3BA01#
				±0.25pF	GRM0335C1H8R3CA01#
			±0.5pF	GRM0335C1H8R3DA01#	
			8.4pF	±0.05pF	GRM0335C1H8R4WA01#
				±0.1pF	GRM0335C1H8R4BA01#
				±0.25pF	GRM0335C1H8R4CA01#
			±0.5pF	GRM0335C1H8R4DA01#	
			8.5pF	±0.05pF	GRM0335C1H8R5WA01#
				±0.1pF	GRM0335C1H8R5BA01#
				±0.25pF	GRM0335C1H8R5CA01#
			±0.5pF	GRM0335C1H8R5DA01#	
			8.6pF	±0.05pF	GRM0335C1H8R6WA01#
				±0.1pF	GRM0335C1H8R6BA01#
				±0.25pF	GRM0335C1H8R6CA01#
			±0.5pF	GRM0335C1H8R6DA01#	
			8.7pF	±0.05pF	GRM0335C1H8R7WA01#
				±0.1pF	GRM0335C1H8R7BA01#
				±0.25pF	GRM0335C1H8R7CA01#
			±0.5pF	GRM0335C1H8R7DA01#	
			8.8pF	±0.05pF	GRM0335C1H8R8WA01#
				±0.1pF	GRM0335C1H8R8BA01#
				±0.25pF	GRM0335C1H8R8CA01#
			±0.5pF	GRM0335C1H8R8DA01#	
			8.9pF	±0.05pF	GRM0335C1H8R9WA01#
				±0.1pF	GRM0335C1H8R9BA01#
±0.25pF	GRM0335C1H8R9CA01#				
±0.5pF	GRM0335C1H8R9DA01#				
9.0pF	±0.05pF	GRM0335C1H9R0WA01#			
	±0.1pF	GRM0335C1H9R0BA01#			
	±0.25pF	GRM0335C1H9R0CA01#			
±0.5pF	GRM0335C1H9R0DA01#				

品番 #には包装仕様コードが入ります。

GRMシリーズ
 GJMシリーズ
 GMAシリーズ
 GMDシリーズ
 GQMシリーズ
 GRJシリーズ
 GR3シリーズ
 KRMシリーズ
 KR3シリーズ
 LLAシリーズ
 LLLシリーズ
 LLMシリーズ
 LLRシリーズ
 △注意/
 使用上の注意

GRMシリーズ 温度補償用 品番表

(→ ■0.6×0.3mm)

T寸法 最大値	定格 電圧	温度 特性	静電容量	許容差	品番
0.33mm	50Vdc	C0G	9.1pF	±0.05pF	GRM0335C1H9R1WA01#
				±0.1pF	GRM0335C1H9R1BA01#
				±0.25pF	GRM0335C1H9R1CA01#
				±0.5pF	GRM0335C1H9R1DA01#
			9.2pF	±0.05pF	GRM0335C1H9R2WA01#
				±0.1pF	GRM0335C1H9R2BA01#
				±0.25pF	GRM0335C1H9R2CA01#
				±0.5pF	GRM0335C1H9R2DA01#
			9.3pF	±0.05pF	GRM0335C1H9R3WA01#
				±0.1pF	GRM0335C1H9R3BA01#
				±0.25pF	GRM0335C1H9R3CA01#
				±0.5pF	GRM0335C1H9R3DA01#
			9.4pF	±0.05pF	GRM0335C1H9R4WA01#
				±0.1pF	GRM0335C1H9R4BA01#
				±0.25pF	GRM0335C1H9R4CA01#
				±0.5pF	GRM0335C1H9R4DA01#
			9.5pF	±0.05pF	GRM0335C1H9R5WA01#
				±0.1pF	GRM0335C1H9R5BA01#
				±0.25pF	GRM0335C1H9R5CA01#
				±0.5pF	GRM0335C1H9R5DA01#
			9.6pF	±0.05pF	GRM0335C1H9R6WA01#
				±0.1pF	GRM0335C1H9R6BA01#
				±0.25pF	GRM0335C1H9R6CA01#
				±0.5pF	GRM0335C1H9R6DA01#
			9.7pF	±0.05pF	GRM0335C1H9R7WA01#
				±0.1pF	GRM0335C1H9R7BA01#
				±0.25pF	GRM0335C1H9R7CA01#
				±0.5pF	GRM0335C1H9R7DA01#
			9.8pF	±0.05pF	GRM0335C1H9R8WA01#
				±0.1pF	GRM0335C1H9R8BA01#
				±0.25pF	GRM0335C1H9R8CA01#
				±0.5pF	GRM0335C1H9R8DA01#
			9.9pF	±0.05pF	GRM0335C1H9R9WA01#
				±0.1pF	GRM0335C1H9R9BA01#
				±0.25pF	GRM0335C1H9R9CA01#
				±0.5pF	GRM0335C1H9R9DA01#
			10pF	±2%	GRM0335C1H100GA01#
				±5%	GRM0335C1H100JA01#
			12pF	±2%	GRM0335C1H120GA01#
				±5%	GRM0335C1H120JA01#
			15pF	±2%	GRM0335C1H150GA01#
				±5%	GRM0335C1H150JA01#
			18pF	±2%	GRM0335C1H180GA01#
				±5%	GRM0335C1H180JA01#
			22pF	±2%	GRM0335C1H220GA01#
				±5%	GRM0335C1H220JA01#
			27pF	±2%	GRM0335C1H270GA01#
				±5%	GRM0335C1H270JA01#
33pF	±2%	GRM0335C1H330GA01#			
	±5%	GRM0335C1H330JA01#			
39pF	±2%	GRM0335C1H390GA01#			
	±5%	GRM0335C1H390JA01#			
47pF	±2%	GRM0335C1H470GA01#			
	±5%	GRM0335C1H470JA01#			

T寸法 最大値	定格 電圧	温度 特性	静電容量	許容差	品番
0.33mm	50Vdc	C0G	56pF	±2%	GRM0335C1H560GA01#
				±5%	GRM0335C1H560JA01#
			68pF	±2%	GRM0335C1H680GA01#
				±5%	GRM0335C1H680JA01#
			82pF	±2%	GRM0335C1H820GA01#
				±5%	GRM0335C1H820JA01#
			100pF	±2%	GRM0335C1H101GA01#
				±5%	GRM0335C1H101JA01#
			120pF	±2%	GRM0335C1H121GA01#
				±5%	GRM0335C1H121JA01#
			150pF	±2%	GRM0335C1H151GA01#
				±5%	GRM0335C1H151JA01#
			180pF	±2%	GRM0335C1H181GA01#
				±5%	GRM0335C1H181JA01#
			220pF	±2%	GRM0335C1H221GA01#
				±5%	GRM0335C1H221JA01#

■1.0×0.5mm

T寸法 最大値	定格 電圧	温度 特性	静電容量	許容差	品番
0.55mm	100Vdc	CK	0.10pF	±0.05pF	GRM1554C2AR10WA01#
				±0.1pF	GRM1554C2AR20BA01#
			0.20pF	±0.05pF	GRM1554C2AR20WA01#
				±0.1pF	GRM1554C2AR20BA01#
			0.30pF	±0.05pF	GRM1554C2AR30WA01#
				±0.1pF	GRM1554C2AR30BA01#
			0.40pF	±0.05pF	GRM1554C2AR40WA01#
				±0.1pF	GRM1554C2AR40BA01#
			0.50pF	±0.05pF	GRM1554C2AR50WA01#
				±0.1pF	GRM1554C2AR50BA01#
			0.60pF	±0.05pF	GRM1554C2AR60WA01#
				±0.1pF	GRM1554C2AR60BA01#
			0.70pF	±0.05pF	GRM1554C2AR70WA01#
				±0.1pF	GRM1554C2AR70BA01#
			0.80pF	±0.05pF	GRM1554C2AR80WA01#
				±0.1pF	GRM1554C2AR80BA01#
			0.90pF	±0.05pF	GRM1554C2AR90WA01#
				±0.1pF	GRM1554C2AR90BA01#
			1.0pF	±0.05pF	GRM1554C2A1R0WA01#
				±0.1pF	GRM1554C2A1R0BA01#
				±0.25pF	GRM1554C2A1R0CA01#
			1.1pF	±0.05pF	GRM1554C2A1R1WA01#
				±0.1pF	GRM1554C2A1R1BA01#
				±0.25pF	GRM1554C2A1R1CA01#
			1.2pF	±0.05pF	GRM1554C2A1R2WA01#
				±0.1pF	GRM1554C2A1R2BA01#
				±0.25pF	GRM1554C2A1R2CA01#
			1.3pF	±0.05pF	GRM1554C2A1R3WA01#
				±0.1pF	GRM1554C2A1R3BA01#
				±0.25pF	GRM1554C2A1R3CA01#
			1.4pF	±0.05pF	GRM1554C2A1R4WA01#
				±0.1pF	GRM1554C2A1R4BA01#
				±0.25pF	GRM1554C2A1R4CA01#
			1.5pF	±0.05pF	GRM1554C2A1R5WA01#

品番 #には包装仕様コードが入ります。

GRMシリーズ
GJMシリーズ
GMAシリーズ
GMDシリーズ
GQMシリーズ
GRJシリーズ
GR3シリーズ
KRMシリーズ
KR3シリーズ
LLAシリーズ
LLLシリーズ
LLMシリーズ
LLRシリーズ
△注意/
使用上の注意

GRMシリーズ 温度補償用 品番表

(→ ■ 1.0×0.5mm)

T寸法 最大値	定格 電圧	温度 特性	静電容量	許容差	品番
0.55mm	100Vdc	CK	1.5pF	±0.1pF	GRM1554C2A1R5BA01#
				±0.25pF	GRM1554C2A1R5CA01#
			1.6pF	±0.05pF	GRM1554C2A1R6WA01#
				±0.1pF	GRM1554C2A1R6BA01#
			±0.25pF	GRM1554C2A1R6CA01#	
				1.7pF	±0.05pF
			±0.1pF		GRM1554C2A1R7BA01#
			±0.25pF		GRM1554C2A1R7CA01#
			1.8pF	±0.05pF	GRM1554C2A1R8WA01#
				±0.1pF	GRM1554C2A1R8BA01#
				±0.25pF	GRM1554C2A1R8CA01#
			1.9pF	±0.05pF	GRM1554C2A1R9WA01#
				±0.1pF	GRM1554C2A1R9BA01#
				±0.25pF	GRM1554C2A1R9CA01#
			2.0pF	±0.05pF	GRM1554C2A2R0WA01#
				±0.1pF	GRM1554C2A2R0BA01#
				±0.25pF	GRM1554C2A2R0CA01#
			2.1pF	±0.05pF	GRM1553C2A2R1WA01#
		±0.1pF			GRM1553C2A2R1BA01#
		±0.25pF			GRM1553C2A2R1CA01#
		2.2pF	±0.05pF	GRM1553C2A2R2WA01#	
				±0.1pF	GRM1553C2A2R2BA01#
				±0.25pF	GRM1553C2A2R2CA01#
		2.3pF	±0.05pF	GRM1553C2A2R3WA01#	
				±0.1pF	GRM1553C2A2R3BA01#
				±0.25pF	GRM1553C2A2R3CA01#
		2.4pF	±0.05pF	GRM1553C2A2R4WA01#	
				±0.1pF	GRM1553C2A2R4BA01#
				±0.25pF	GRM1553C2A2R4CA01#
		2.5pF	±0.05pF	GRM1553C2A2R5WA01#	
				±0.1pF	GRM1553C2A2R5BA01#
				±0.25pF	GRM1553C2A2R5CA01#
		2.6pF	±0.05pF	GRM1553C2A2R6WA01#	
				±0.1pF	GRM1553C2A2R6BA01#
				±0.25pF	GRM1553C2A2R6CA01#
		2.7pF	±0.05pF	GRM1553C2A2R7WA01#	
				±0.1pF	GRM1553C2A2R7BA01#
				±0.25pF	GRM1553C2A2R7CA01#
		2.8pF	±0.05pF	GRM1553C2A2R8WA01#	
				±0.1pF	GRM1553C2A2R8BA01#
				±0.25pF	GRM1553C2A2R8CA01#
		2.9pF	±0.05pF	GRM1553C2A2R9WA01#	
±0.1pF	GRM1553C2A2R9BA01#				
±0.25pF	GRM1553C2A2R9CA01#				
3.0pF	±0.05pF	GRM1553C2A3R0WA01#			
		±0.1pF	GRM1553C2A3R0BA01#		
		±0.25pF	GRM1553C2A3R0CA01#		
3.1pF	±0.05pF	GRM1553C2A3R1WA01#			
		±0.1pF	GRM1553C2A3R1BA01#		
		±0.25pF	GRM1553C2A3R1CA01#		
3.2pF	±0.05pF	GRM1553C2A3R2WA01#			
		±0.1pF	GRM1553C2A3R2BA01#		
		±0.25pF	GRM1553C2A3R2CA01#		
3.3pF	±0.05pF	GRM1553C2A3R3WA01#			

T寸法 最大値	定格 電圧	温度 特性	静電容量	許容差	品番
0.55mm	100Vdc	CJ	3.3pF	±0.1pF	GRM1553C2A3R3BA01#
				±0.25pF	GRM1553C2A3R3CA01#
			3.4pF	±0.05pF	GRM1553C2A3R4WA01#
				±0.1pF	GRM1553C2A3R4BA01#
			±0.25pF	GRM1553C2A3R4CA01#	
				3.5pF	±0.05pF
			±0.1pF		GRM1553C2A3R5BA01#
			±0.25pF		GRM1553C2A3R5CA01#
			3.6pF	±0.05pF	GRM1553C2A3R6WA01#
				±0.1pF	GRM1553C2A3R6BA01#
				±0.25pF	GRM1553C2A3R6CA01#
			3.7pF	±0.05pF	GRM1553C2A3R7WA01#
				±0.1pF	GRM1553C2A3R7BA01#
				±0.25pF	GRM1553C2A3R7CA01#
			3.8pF	±0.05pF	GRM1553C2A3R8WA01#
				±0.1pF	GRM1553C2A3R8BA01#
				±0.25pF	GRM1553C2A3R8CA01#
			3.9pF	±0.05pF	GRM1553C2A3R9WA01#
		±0.1pF		GRM1553C2A3R9BA01#	
		±0.25pF		GRM1553C2A3R9CA01#	
		CH	4.0pF	±0.05pF	GRM1552C2A4R0WA01#
				±0.1pF	GRM1552C2A4R0BA01#
				±0.25pF	GRM1552C2A4R0CA01#
			4.1pF	±0.05pF	GRM1552C2A4R1WA01#
				±0.1pF	GRM1552C2A4R1BA01#
				±0.25pF	GRM1552C2A4R1CA01#
			4.2pF	±0.05pF	GRM1552C2A4R2WA01#
				±0.1pF	GRM1552C2A4R2BA01#
				±0.25pF	GRM1552C2A4R2CA01#
			4.3pF	±0.05pF	GRM1552C2A4R3WA01#
				±0.1pF	GRM1552C2A4R3BA01#
				±0.25pF	GRM1552C2A4R3CA01#
			4.4pF	±0.05pF	GRM1552C2A4R4WA01#
				±0.1pF	GRM1552C2A4R4BA01#
		±0.25pF		GRM1552C2A4R4CA01#	
		4.5pF	±0.05pF	GRM1552C2A4R5WA01#	
			±0.1pF	GRM1552C2A4R5BA01#	
			±0.25pF	GRM1552C2A4R5CA01#	
		4.6pF	±0.05pF	GRM1552C2A4R6WA01#	
			±0.1pF	GRM1552C2A4R6BA01#	
			±0.25pF	GRM1552C2A4R6CA01#	
		4.7pF	±0.05pF	GRM1552C2A4R7WA01#	
±0.1pF	GRM1552C2A4R7BA01#				
±0.25pF	GRM1552C2A4R7CA01#				
4.8pF	±0.05pF	GRM1552C2A4R8WA01#			
	±0.1pF	GRM1552C2A4R8BA01#			
	±0.25pF	GRM1552C2A4R8CA01#			
4.9pF	±0.05pF	GRM1552C2A4R9WA01#			
	±0.1pF	GRM1552C2A4R9BA01#			
	±0.25pF	GRM1552C2A4R9CA01#			
5.0pF	±0.05pF	GRM1552C2A5R0WA01#			
	±0.1pF	GRM1552C2A5R0BA01#			
±0.25pF	GRM1552C2A5R0CA01#				
	5.1pF	±0.05pF	GRM1552C2A5R1WA01#		

品番 #には包装仕様コードが入ります。

GRMシリーズ
 GJMシリーズ
 GMAシリーズ
 GMDシリーズ
 GQMシリーズ
 GRJシリーズ
 GR3シリーズ
 KRMシリーズ
 KR3シリーズ
 LLAシリーズ
 LLMシリーズ
 LLRシリーズ
 △注意/
 使用上の注意

GRMシリーズ 温度補償用 品番表

(→ ■ 1.0×0.5mm)

T寸法 最大値	定格 電圧	温度 特性	静電容量	許容差	品番
0.55mm	100Vdc	CH	5.1pF	±0.1pF	GRM1552C2A5R1BA01#
				±0.25pF	GRM1552C2A5R1CA01#
				±0.5pF	GRM1552C2A5R1DA01#
			5.2pF	±0.05pF	GRM1552C2A5R2WA01#
				±0.1pF	GRM1552C2A5R2BA01#
				±0.25pF	GRM1552C2A5R2CA01#
			5.3pF	±0.05pF	GRM1552C2A5R3WA01#
				±0.1pF	GRM1552C2A5R3BA01#
				±0.25pF	GRM1552C2A5R3CA01#
			5.4pF	±0.05pF	GRM1552C2A5R4WA01#
				±0.1pF	GRM1552C2A5R4BA01#
				±0.25pF	GRM1552C2A5R4CA01#
			5.5pF	±0.05pF	GRM1552C2A5R5WA01#
				±0.1pF	GRM1552C2A5R5BA01#
				±0.25pF	GRM1552C2A5R5CA01#
			5.6pF	±0.05pF	GRM1552C2A5R6WA01#
				±0.1pF	GRM1552C2A5R6BA01#
				±0.25pF	GRM1552C2A5R6CA01#
			5.7pF	±0.05pF	GRM1552C2A5R7WA01#
				±0.1pF	GRM1552C2A5R7BA01#
				±0.25pF	GRM1552C2A5R7CA01#
			5.8pF	±0.05pF	GRM1552C2A5R8WA01#
				±0.1pF	GRM1552C2A5R8BA01#
				±0.25pF	GRM1552C2A5R8CA01#
			5.9pF	±0.05pF	GRM1552C2A5R9WA01#
				±0.1pF	GRM1552C2A5R9BA01#
				±0.25pF	GRM1552C2A5R9CA01#
			6.0pF	±0.05pF	GRM1552C2A6R0WA01#
				±0.1pF	GRM1552C2A6R0BA01#
				±0.25pF	GRM1552C2A6R0CA01#
			6.1pF	±0.05pF	GRM1552C2A6R1WA01#
				±0.1pF	GRM1552C2A6R1BA01#
				±0.25pF	GRM1552C2A6R1CA01#
			6.2pF	±0.05pF	GRM1552C2A6R2WA01#
				±0.1pF	GRM1552C2A6R2BA01#
				±0.25pF	GRM1552C2A6R2CA01#
			6.3pF	±0.05pF	GRM1552C2A6R3WA01#
				±0.1pF	GRM1552C2A6R3BA01#
				±0.25pF	GRM1552C2A6R3CA01#
			6.4pF	±0.05pF	GRM1552C2A6R4WA01#
				±0.1pF	GRM1552C2A6R4BA01#
				±0.25pF	GRM1552C2A6R4CA01#

T寸法 最大値	定格 電圧	温度 特性	静電容量	許容差	品番
0.55mm	100Vdc	CH	6.4pF	±0.5pF	GRM1552C2A6R4DA01#
				±0.05pF	GRM1552C2A6R5WA01#
				±0.1pF	GRM1552C2A6R5BA01#
			6.5pF	±0.25pF	GRM1552C2A6R5CA01#
				±0.5pF	GRM1552C2A6R5DA01#
				6.6pF	±0.05pF
			±0.1pF		GRM1552C2A6R6BA01#
			±0.25pF		GRM1552C2A6R6CA01#
			6.7pF	±0.05pF	GRM1552C2A6R7WA01#
				±0.1pF	GRM1552C2A6R7BA01#
				±0.25pF	GRM1552C2A6R7CA01#
			6.8pF	±0.05pF	GRM1552C2A6R8WA01#
				±0.1pF	GRM1552C2A6R8BA01#
				±0.25pF	GRM1552C2A6R8CA01#
			6.9pF	±0.05pF	GRM1552C2A6R9WA01#
				±0.1pF	GRM1552C2A6R9BA01#
				±0.25pF	GRM1552C2A6R9CA01#
			7.0pF	±0.05pF	GRM1552C2A7R0WA01#
				±0.1pF	GRM1552C2A7R0BA01#
				±0.25pF	GRM1552C2A7R0CA01#
			7.1pF	±0.05pF	GRM1552C2A7R1WA01#
				±0.1pF	GRM1552C2A7R1BA01#
				±0.25pF	GRM1552C2A7R1CA01#
			7.2pF	±0.05pF	GRM1552C2A7R2WA01#
				±0.1pF	GRM1552C2A7R2BA01#
				±0.25pF	GRM1552C2A7R2CA01#
			7.3pF	±0.05pF	GRM1552C2A7R3WA01#
				±0.1pF	GRM1552C2A7R3BA01#
				±0.25pF	GRM1552C2A7R3CA01#
			7.4pF	±0.05pF	GRM1552C2A7R4WA01#
				±0.1pF	GRM1552C2A7R4BA01#
				±0.25pF	GRM1552C2A7R4CA01#
			7.5pF	±0.05pF	GRM1552C2A7R5WA01#
				±0.1pF	GRM1552C2A7R5BA01#
				±0.25pF	GRM1552C2A7R5CA01#
			7.6pF	±0.05pF	GRM1552C2A7R6WA01#
				±0.1pF	GRM1552C2A7R6BA01#
				±0.25pF	GRM1552C2A7R6CA01#
			7.7pF	±0.05pF	GRM1552C2A7R7WA01#
				±0.1pF	GRM1552C2A7R7BA01#
				±0.25pF	GRM1552C2A7R7CA01#
			7.8pF	±0.05pF	GRM1552C2A7R8WA01#
				±0.1pF	GRM1552C2A7R8BA01#
				±0.25pF	GRM1552C2A7R8CA01#

品番 #には包装仕様コードが入ります。

GRMシリーズ 温度補償用 品番表

(→ ■ 1.0×0.5mm)

T寸法 最大値	定格 電圧	温度 特性	静電容量	許容差	品番
0.55mm	100Vdc	CH	7.8pF	±0.1pF	GRM1552C2A7R8BA01#
				±0.25pF	GRM1552C2A7R8CA01#
				±0.5pF	GRM1552C2A7R8DA01#
			7.9pF	±0.05pF	GRM1552C2A7R9WA01#
				±0.1pF	GRM1552C2A7R9BA01#
				±0.25pF	GRM1552C2A7R9CA01#
			8.0pF	±0.05pF	GRM1552C2A8R0WA01#
				±0.1pF	GRM1552C2A8R0BA01#
				±0.25pF	GRM1552C2A8R0CA01#
			8.1pF	±0.05pF	GRM1552C2A8R1WA01#
				±0.1pF	GRM1552C2A8R1BA01#
				±0.25pF	GRM1552C2A8R1CA01#
			8.2pF	±0.05pF	GRM1552C2A8R2WA01#
				±0.1pF	GRM1552C2A8R2BA01#
				±0.25pF	GRM1552C2A8R2CA01#
			8.3pF	±0.05pF	GRM1552C2A8R3WA01#
				±0.1pF	GRM1552C2A8R3BA01#
				±0.25pF	GRM1552C2A8R3CA01#
			8.4pF	±0.05pF	GRM1552C2A8R4WA01#
				±0.1pF	GRM1552C2A8R4BA01#
				±0.25pF	GRM1552C2A8R4CA01#
			8.5pF	±0.05pF	GRM1552C2A8R5WA01#
				±0.1pF	GRM1552C2A8R5BA01#
				±0.25pF	GRM1552C2A8R5CA01#
			8.6pF	±0.05pF	GRM1552C2A8R6WA01#
				±0.1pF	GRM1552C2A8R6BA01#
				±0.25pF	GRM1552C2A8R6CA01#
			8.7pF	±0.05pF	GRM1552C2A8R7WA01#
				±0.1pF	GRM1552C2A8R7BA01#
				±0.25pF	GRM1552C2A8R7CA01#
			8.8pF	±0.05pF	GRM1552C2A8R8WA01#
				±0.1pF	GRM1552C2A8R8BA01#
				±0.25pF	GRM1552C2A8R8CA01#
			8.9pF	±0.05pF	GRM1552C2A8R9WA01#
				±0.1pF	GRM1552C2A8R9BA01#
				±0.25pF	GRM1552C2A8R9CA01#
			9.0pF	±0.05pF	GRM1552C2A9R0WA01#
				±0.1pF	GRM1552C2A9R0BA01#
				±0.25pF	GRM1552C2A9R0CA01#
			9.1pF	±0.05pF	GRM1552C2A9R1WA01#
				±0.1pF	GRM1552C2A9R1BA01#
				±0.25pF	GRM1552C2A9R1CA01#

T寸法 最大値	定格 電圧	温度 特性	静電容量	許容差	品番
0.55mm	100Vdc	CH	9.1pF	±0.5pF	GRM1552C2A9R1DA01#
				±0.05pF	GRM1552C2A9R2WA01#
				±0.1pF	GRM1552C2A9R2BA01#
			9.2pF	±0.25pF	GRM1552C2A9R2CA01#
				±0.5pF	GRM1552C2A9R2DA01#
				9.3pF	±0.05pF
			±0.1pF		GRM1552C2A9R3BA01#
			±0.25pF		GRM1552C2A9R3CA01#
			9.4pF	±0.05pF	GRM1552C2A9R4WA01#
				±0.1pF	GRM1552C2A9R4BA01#
				±0.25pF	GRM1552C2A9R4CA01#
			9.5pF	±0.05pF	GRM1552C2A9R5WA01#
				±0.1pF	GRM1552C2A9R5BA01#
				±0.25pF	GRM1552C2A9R5CA01#
			9.6pF	±0.05pF	GRM1552C2A9R6WA01#
				±0.1pF	GRM1552C2A9R6BA01#
				±0.25pF	GRM1552C2A9R6CA01#
			9.7pF	±0.05pF	GRM1552C2A9R7WA01#
				±0.1pF	GRM1552C2A9R7BA01#
				±0.25pF	GRM1552C2A9R7CA01#
			9.8pF	±0.05pF	GRM1552C2A9R8WA01#
				±0.1pF	GRM1552C2A9R8BA01#
				±0.25pF	GRM1552C2A9R8CA01#
			9.9pF	±0.05pF	GRM1552C2A9R9WA01#
				±0.1pF	GRM1552C2A9R9BA01#
				±0.25pF	GRM1552C2A9R9CA01#
			10pF	±2%	GRM1552C2A100GA01#
				±5%	GRM1552C2A100JA01#
			12pF	±2%	GRM1552C2A120GA01#
				±5%	GRM1552C2A120JA01#
			15pF	±2%	GRM1552C2A150GA01#
				±5%	GRM1552C2A150JA01#
			18pF	±2%	GRM1552C2A180GA01#
				±5%	GRM1552C2A180JA01#
			22pF	±2%	GRM1552C2A220GA01#
				±5%	GRM1552C2A220JA01#
			27pF	±2%	GRM1552C2A270GA01#
				±5%	GRM1552C2A270JA01#
			33pF	±2%	GRM1552C2A330GA01#
				±5%	GRM1552C2A330JA01#
			39pF	±2%	GRM1552C2A390GA01#
				±5%	GRM1552C2A390JA01#
			47pF	±2%	GRM1552C2A470GA01#
				±5%	GRM1552C2A470JA01#
			56pF	±2%	GRM1552C2A560GA01#
				±5%	GRM1552C2A560JA01#
			68pF	±2%	GRM1552C2A680GA01#

品番 #には包装仕様コードが入ります。

GRMシリーズ
 GJMシリーズ
 GMAシリーズ
 GMDシリーズ
 GQMシリーズ
 GRJシリーズ
 GR3シリーズ
 KRMシリーズ
 KR3シリーズ
 LLAシリーズ
 LLLシリーズ
 LLMシリーズ
 LLRシリーズ
 △注意/
 使用上の注意

GRMシリーズ 温度補償用 品番表

(→ ■ 1.0×0.5mm)

T寸法 最大値	定格 電圧	温度 特性	静電容量	許容差	品番	
0.55mm	100Vdc	CH	68pF	±5%	GRM1552C2A680JA01#	
				±2%	GRM1552C2A820GA01#	
			82pF	±5%	GRM1552C2A820JA01#	
				±2%	GRM1552C2A101GA01#	
			100pF	±5%	GRM1552C2A101JA01#	
				COG	0.10pF	±0.05pF
			±0.05pF			GRM1555C2AR20WA01#
			0.20pF		±0.1pF	GRM1555C2AR20BA01#
		±0.05pF			GRM1555C2AR30WA01#	
		0.30pF	±0.1pF		GRM1555C2AR30BA01#	
			±0.05pF		GRM1555C2AR40WA01#	
		0.40pF	±0.1pF		GRM1555C2AR40BA01#	
			±0.05pF		GRM1555C2AR50WA01#	
		0.50pF	±0.1pF		GRM1555C2AR50BA01#	
			±0.05pF		GRM1555C2AR60WA01#	
		0.60pF	±0.1pF		GRM1555C2AR60BA01#	
			±0.05pF		GRM1555C2AR70WA01#	
		0.70pF	±0.1pF		GRM1555C2AR70BA01#	
			±0.05pF		GRM1555C2AR80WA01#	
		0.80pF	±0.1pF		GRM1555C2AR80BA01#	
			±0.05pF		GRM1555C2AR90WA01#	
		0.90pF	±0.1pF		GRM1555C2AR90BA01#	
			±0.05pF		GRM1555C2A1R0WA01#	
		1.0pF	±0.1pF		GRM1555C2A1R0BA01#	
			±0.25pF		GRM1555C2A1R0CA01#	
			±0.05pF		GRM1555C2A1R1WA01#	
		1.1pF	±0.1pF		GRM1555C2A1R1BA01#	
			±0.25pF		GRM1555C2A1R1CA01#	
			±0.05pF		GRM1555C2A1R2WA01#	
		1.2pF	±0.1pF		GRM1555C2A1R2BA01#	
			±0.25pF		GRM1555C2A1R2CA01#	
			±0.05pF		GRM1555C2A1R3WA01#	
		1.3pF	±0.1pF		GRM1555C2A1R3BA01#	
			±0.25pF		GRM1555C2A1R3CA01#	
			±0.05pF		GRM1555C2A1R4WA01#	
		1.4pF	±0.1pF		GRM1555C2A1R4BA01#	
			±0.25pF		GRM1555C2A1R4CA01#	
			±0.05pF	GRM1555C2A1R5WA01#		
		1.5pF	±0.1pF	GRM1555C2A1R5BA01#		
			±0.25pF	GRM1555C2A1R5CA01#		
			±0.05pF	GRM1555C2A1R6WA01#		
		1.6pF	±0.1pF	GRM1555C2A1R6BA01#		
			±0.25pF	GRM1555C2A1R6CA01#		
			±0.05pF	GRM1555C2A1R7WA01#		
1.7pF	±0.1pF	GRM1555C2A1R7BA01#				
	±0.25pF	GRM1555C2A1R7CA01#				
	±0.05pF	GRM1555C2A1R8WA01#				
1.8pF	±0.1pF	GRM1555C2A1R8BA01#				
	±0.25pF	GRM1555C2A1R8CA01#				
	±0.05pF	GRM1555C2A1R9WA01#				
1.9pF	±0.1pF	GRM1555C2A1R9BA01#				
	±0.25pF	GRM1555C2A1R9CA01#				
	±0.05pF	GRM1555C2A2R0WA01#				
2.0pF	±0.1pF	GRM1555C2A2R0BA01#				

T寸法 最大値	定格 電圧	温度 特性	静電容量	許容差	品番
0.55mm	100Vdc	COG	2.0pF	±0.25pF	GRM1555C2A2R0CA01#
				±0.05pF	GRM1555C2A2R1WA01#
			2.1pF	±0.1pF	GRM1555C2A2R1BA01#
				±0.25pF	GRM1555C2A2R1CA01#
			2.2pF	±0.05pF	GRM1555C2A2R2WA01#
				±0.1pF	GRM1555C2A2R2BA01#
			2.3pF	±0.25pF	GRM1555C2A2R2CA01#
				±0.05pF	GRM1555C2A2R3WA01#
			2.4pF	±0.1pF	GRM1555C2A2R3BA01#
				±0.25pF	GRM1555C2A2R3CA01#
			2.5pF	±0.05pF	GRM1555C2A2R4WA01#
				±0.1pF	GRM1555C2A2R4BA01#
			2.6pF	±0.25pF	GRM1555C2A2R4CA01#
				±0.05pF	GRM1555C2A2R5WA01#
			2.7pF	±0.1pF	GRM1555C2A2R5BA01#
				±0.25pF	GRM1555C2A2R5CA01#
			2.8pF	±0.05pF	GRM1555C2A2R6WA01#
				±0.1pF	GRM1555C2A2R6BA01#
			2.9pF	±0.25pF	GRM1555C2A2R6CA01#
				±0.05pF	GRM1555C2A2R7WA01#
			3.0pF	±0.1pF	GRM1555C2A2R7BA01#
				±0.25pF	GRM1555C2A2R7CA01#
			3.1pF	±0.05pF	GRM1555C2A2R8WA01#
				±0.1pF	GRM1555C2A2R8BA01#
			3.2pF	±0.25pF	GRM1555C2A2R8CA01#
				±0.05pF	GRM1555C2A2R9WA01#
			3.3pF	±0.1pF	GRM1555C2A2R9BA01#
				±0.25pF	GRM1555C2A2R9CA01#
			3.4pF	±0.05pF	GRM1555C2A3R0WA01#
				±0.1pF	GRM1555C2A3R0BA01#
			3.5pF	±0.25pF	GRM1555C2A3R0CA01#
				±0.05pF	GRM1555C2A3R1WA01#
			3.6pF	±0.1pF	GRM1555C2A3R1BA01#
				±0.25pF	GRM1555C2A3R1CA01#
			3.7pF	±0.05pF	GRM1555C2A3R2WA01#
				±0.1pF	GRM1555C2A3R2BA01#
			3.8pF	±0.25pF	GRM1555C2A3R2CA01#
				±0.05pF	GRM1555C2A3R3WA01#
			3.9pF	±0.1pF	GRM1555C2A3R3BA01#
				±0.25pF	GRM1555C2A3R3CA01#
			4.0pF	±0.05pF	GRM1555C2A3R4WA01#
				±0.1pF	GRM1555C2A3R4BA01#
			4.1pF	±0.25pF	GRM1555C2A3R4CA01#
				±0.05pF	GRM1555C2A3R5WA01#
4.2pF	±0.1pF	GRM1555C2A3R5BA01#			
	±0.25pF	GRM1555C2A3R5CA01#			
4.3pF	±0.05pF	GRM1555C2A3R6WA01#			
	±0.1pF	GRM1555C2A3R6BA01#			
4.4pF	±0.25pF	GRM1555C2A3R6CA01#			
	±0.05pF	GRM1555C2A3R7WA01#			
4.5pF	±0.1pF	GRM1555C2A3R7BA01#			
	±0.25pF	GRM1555C2A3R7CA01#			
4.6pF	±0.05pF	GRM1555C2A3R8WA01#			
	±0.1pF	GRM1555C2A3R8BA01#			

品番 #には包装仕様コードが入ります。

GRMシリーズ
GJMシリーズ
GMAシリーズ
GMDシリーズ
GQMシリーズ
GRJシリーズ
GR3シリーズ
KRMシリーズ
KR3シリーズ
LLAシリーズ
LLLシリーズ
LLMシリーズ
LLRシリーズ
△注意/
使用上の注意

GRMシリーズ 温度補償用 品番表

(→ ■ 1.0×0.5mm)

T寸法 最大値	定格 電圧	温度 特性	静電容量	許容差	品番
0.55mm	100Vdc	C0G	3.8pF	±0.25pF	GRM1555C2A3R8CA01#
				±0.05pF	GRM1555C2A3R9WA01#
					±0.1pF
			±0.25pF		GRM1555C2A3R9CA01#
			4.0pF	±0.05pF	GRM1555C2A4R0WA01#
				±0.1pF	GRM1555C2A4R0BA01#
				±0.25pF	GRM1555C2A4R0CA01#
			4.1pF	±0.05pF	GRM1555C2A4R1WA01#
				±0.1pF	GRM1555C2A4R1BA01#
				±0.25pF	GRM1555C2A4R1CA01#
			4.2pF	±0.05pF	GRM1555C2A4R2WA01#
				±0.1pF	GRM1555C2A4R2BA01#
				±0.25pF	GRM1555C2A4R2CA01#
			4.3pF	±0.05pF	GRM1555C2A4R3WA01#
				±0.1pF	GRM1555C2A4R3BA01#
				±0.25pF	GRM1555C2A4R3CA01#
			4.4pF	±0.05pF	GRM1555C2A4R4WA01#
				±0.1pF	GRM1555C2A4R4BA01#
				±0.25pF	GRM1555C2A4R4CA01#
			4.5pF	±0.05pF	GRM1555C2A4R5WA01#
				±0.1pF	GRM1555C2A4R5BA01#
				±0.25pF	GRM1555C2A4R5CA01#
			4.6pF	±0.05pF	GRM1555C2A4R6WA01#
				±0.1pF	GRM1555C2A4R6BA01#
				±0.25pF	GRM1555C2A4R6CA01#
			4.7pF	±0.05pF	GRM1555C2A4R7WA01#
				±0.1pF	GRM1555C2A4R7BA01#
				±0.25pF	GRM1555C2A4R7CA01#
			4.8pF	±0.05pF	GRM1555C2A4R8WA01#
				±0.1pF	GRM1555C2A4R8BA01#
				±0.25pF	GRM1555C2A4R8CA01#
			4.9pF	±0.05pF	GRM1555C2A4R9WA01#
				±0.1pF	GRM1555C2A4R9BA01#
				±0.25pF	GRM1555C2A4R9CA01#
			5.0pF	±0.05pF	GRM1555C2A5R0WA01#
				±0.1pF	GRM1555C2A5R0BA01#
				±0.25pF	GRM1555C2A5R0CA01#
			5.1pF	±0.05pF	GRM1555C2A5R1WA01#
				±0.1pF	GRM1555C2A5R1BA01#
				±0.25pF	GRM1555C2A5R1CA01#
				±0.5pF	GRM1555C2A5R1DA01#
			5.2pF	±0.05pF	GRM1555C2A5R2WA01#
				±0.1pF	GRM1555C2A5R2BA01#
				±0.25pF	GRM1555C2A5R2CA01#
				±0.5pF	GRM1555C2A5R2DA01#
5.3pF	±0.05pF	GRM1555C2A5R3WA01#			
	±0.1pF	GRM1555C2A5R3BA01#			
	±0.25pF	GRM1555C2A5R3CA01#			
	±0.5pF	GRM1555C2A5R3DA01#			
5.4pF	±0.05pF	GRM1555C2A5R4WA01#			
	±0.1pF	GRM1555C2A5R4BA01#			
	±0.25pF	GRM1555C2A5R4CA01#			
	±0.5pF	GRM1555C2A5R4DA01#			
5.5pF	±0.05pF	GRM1555C2A5R5WA01#			

T寸法 最大値	定格 電圧	温度 特性	静電容量	許容差	品番
0.55mm	100Vdc	C0G	5.5pF	±0.1pF	GRM1555C2A5R5BA01#
				±0.25pF	GRM1555C2A5R5CA01#
				±0.5pF	GRM1555C2A5R5DA01#
			5.6pF	±0.05pF	GRM1555C2A5R6WA01#
				±0.1pF	GRM1555C2A5R6BA01#
				±0.25pF	GRM1555C2A5R6CA01#
				±0.5pF	GRM1555C2A5R6DA01#
			5.7pF	±0.05pF	GRM1555C2A5R7WA01#
				±0.1pF	GRM1555C2A5R7BA01#
				±0.25pF	GRM1555C2A5R7CA01#
				±0.5pF	GRM1555C2A5R7DA01#
			5.8pF	±0.05pF	GRM1555C2A5R8WA01#
				±0.1pF	GRM1555C2A5R8BA01#
				±0.25pF	GRM1555C2A5R8CA01#
				±0.5pF	GRM1555C2A5R8DA01#
			5.9pF	±0.05pF	GRM1555C2A5R9WA01#
				±0.1pF	GRM1555C2A5R9BA01#
				±0.25pF	GRM1555C2A5R9CA01#
				±0.5pF	GRM1555C2A5R9DA01#
			6.0pF	±0.05pF	GRM1555C2A6R0WA01#
				±0.1pF	GRM1555C2A6R0BA01#
				±0.25pF	GRM1555C2A6R0CA01#
				±0.5pF	GRM1555C2A6R0DA01#
			6.1pF	±0.05pF	GRM1555C2A6R1WA01#
				±0.1pF	GRM1555C2A6R1BA01#
				±0.25pF	GRM1555C2A6R1CA01#
				±0.5pF	GRM1555C2A6R1DA01#
			6.2pF	±0.05pF	GRM1555C2A6R2WA01#
				±0.1pF	GRM1555C2A6R2BA01#
				±0.25pF	GRM1555C2A6R2CA01#
				±0.5pF	GRM1555C2A6R2DA01#
			6.3pF	±0.05pF	GRM1555C2A6R3WA01#
				±0.1pF	GRM1555C2A6R3BA01#
				±0.25pF	GRM1555C2A6R3CA01#
				±0.5pF	GRM1555C2A6R3DA01#
			6.4pF	±0.05pF	GRM1555C2A6R4WA01#
				±0.1pF	GRM1555C2A6R4BA01#
				±0.25pF	GRM1555C2A6R4CA01#
				±0.5pF	GRM1555C2A6R4DA01#
			6.5pF	±0.05pF	GRM1555C2A6R5WA01#
				±0.1pF	GRM1555C2A6R5BA01#
				±0.25pF	GRM1555C2A6R5CA01#
				±0.5pF	GRM1555C2A6R5DA01#
			6.6pF	±0.05pF	GRM1555C2A6R6WA01#
				±0.1pF	GRM1555C2A6R6BA01#
±0.25pF	GRM1555C2A6R6CA01#				
±0.5pF	GRM1555C2A6R6DA01#				
6.7pF	±0.05pF	GRM1555C2A6R7WA01#			
	±0.1pF	GRM1555C2A6R7BA01#			
	±0.25pF	GRM1555C2A6R7CA01#			
	±0.5pF	GRM1555C2A6R7DA01#			
6.8pF	±0.05pF	GRM1555C2A6R8WA01#			
	±0.1pF	GRM1555C2A6R8BA01#			
	±0.25pF	GRM1555C2A6R8CA01#			

品番 #には包装仕様コードが入ります。

GRMシリーズ
 GJMシリーズ
 GMAシリーズ
 GMDシリーズ
 GQMシリーズ
 GRJシリーズ
 GR3シリーズ
 KRMシリーズ
 KR3シリーズ
 LLAシリーズ
 LLLシリーズ
 LLMシリーズ
 LLRシリーズ
 △注意/
 使用上の注意

GRMシリーズ 温度補償用 品番表

(→ ■ 1.0×0.5mm)

T寸法 最大値	定格 電圧	温度 特性	静電容量	許容差	品番
0.55mm	100Vdc	C0G	6.8pF	±0.5pF	GRM1555C2A6R8DA01#
				±0.05pF	GRM1555C2A6R9WA01#
			6.9pF	±0.1pF	GRM1555C2A6R9BA01#
				±0.25pF	GRM1555C2A6R9CA01#
				±0.5pF	GRM1555C2A6R9DA01#
				7.0pF	±0.05pF
			±0.1pF		GRM1555C2A7R0BA01#
			±0.25pF		GRM1555C2A7R0CA01#
			±0.5pF		GRM1555C2A7R0DA01#
			7.1pF	±0.05pF	GRM1555C2A7R1WA01#
				±0.1pF	GRM1555C2A7R1BA01#
				±0.25pF	GRM1555C2A7R1CA01#
				±0.5pF	GRM1555C2A7R1DA01#
			7.2pF	±0.05pF	GRM1555C2A7R2WA01#
				±0.1pF	GRM1555C2A7R2BA01#
				±0.25pF	GRM1555C2A7R2CA01#
				±0.5pF	GRM1555C2A7R2DA01#
			7.3pF	±0.05pF	GRM1555C2A7R3WA01#
				±0.1pF	GRM1555C2A7R3BA01#
				±0.25pF	GRM1555C2A7R3CA01#
				±0.5pF	GRM1555C2A7R3DA01#
			7.4pF	±0.05pF	GRM1555C2A7R4WA01#
				±0.1pF	GRM1555C2A7R4BA01#
				±0.25pF	GRM1555C2A7R4CA01#
				±0.5pF	GRM1555C2A7R4DA01#
			7.5pF	±0.05pF	GRM1555C2A7R5WA01#
				±0.1pF	GRM1555C2A7R5BA01#
				±0.25pF	GRM1555C2A7R5CA01#
				±0.5pF	GRM1555C2A7R5DA01#
			7.6pF	±0.05pF	GRM1555C2A7R6WA01#
				±0.1pF	GRM1555C2A7R6BA01#
				±0.25pF	GRM1555C2A7R6CA01#
				±0.5pF	GRM1555C2A7R6DA01#
			7.7pF	±0.05pF	GRM1555C2A7R7WA01#
				±0.1pF	GRM1555C2A7R7BA01#
				±0.25pF	GRM1555C2A7R7CA01#
				±0.5pF	GRM1555C2A7R7DA01#
			7.8pF	±0.05pF	GRM1555C2A7R8WA01#
				±0.1pF	GRM1555C2A7R8BA01#
				±0.25pF	GRM1555C2A7R8CA01#
				±0.5pF	GRM1555C2A7R8DA01#
			7.9pF	±0.05pF	GRM1555C2A7R9WA01#
				±0.1pF	GRM1555C2A7R9BA01#
				±0.25pF	GRM1555C2A7R9CA01#
				±0.5pF	GRM1555C2A7R9DA01#
			8.0pF	±0.05pF	GRM1555C2A8R0WA01#
				±0.1pF	GRM1555C2A8R0BA01#
				±0.25pF	GRM1555C2A8R0CA01#
				±0.5pF	GRM1555C2A8R0DA01#
			8.1pF	±0.05pF	GRM1555C2A8R1WA01#
				±0.1pF	GRM1555C2A8R1BA01#
				±0.25pF	GRM1555C2A8R1CA01#
±0.5pF	GRM1555C2A8R1DA01#				
8.2pF	±0.05pF	GRM1555C2A8R2WA01#			

T寸法 最大値	定格 電圧	温度 特性	静電容量	許容差	品番
0.55mm	100Vdc	C0G	8.2pF	±0.1pF	GRM1555C2A8R2BA01#
				±0.25pF	GRM1555C2A8R2CA01#
				±0.5pF	GRM1555C2A8R2DA01#
			8.3pF	±0.05pF	GRM1555C2A8R3WA01#
				±0.1pF	GRM1555C2A8R3BA01#
				±0.25pF	GRM1555C2A8R3CA01#
			8.4pF	±0.05pF	GRM1555C2A8R4WA01#
				±0.1pF	GRM1555C2A8R4BA01#
				±0.25pF	GRM1555C2A8R4CA01#
			8.5pF	±0.05pF	GRM1555C2A8R5WA01#
				±0.1pF	GRM1555C2A8R5BA01#
				±0.25pF	GRM1555C2A8R5CA01#
			8.6pF	±0.05pF	GRM1555C2A8R6WA01#
				±0.1pF	GRM1555C2A8R6BA01#
				±0.25pF	GRM1555C2A8R6CA01#
			8.7pF	±0.05pF	GRM1555C2A8R7WA01#
				±0.1pF	GRM1555C2A8R7BA01#
				±0.25pF	GRM1555C2A8R7CA01#
			8.8pF	±0.05pF	GRM1555C2A8R8WA01#
				±0.1pF	GRM1555C2A8R8BA01#
				±0.25pF	GRM1555C2A8R8CA01#
			8.9pF	±0.05pF	GRM1555C2A8R9WA01#
				±0.1pF	GRM1555C2A8R9BA01#
				±0.25pF	GRM1555C2A8R9CA01#
			9.0pF	±0.05pF	GRM1555C2A9R0WA01#
				±0.1pF	GRM1555C2A9R0BA01#
				±0.25pF	GRM1555C2A9R0CA01#
			9.1pF	±0.05pF	GRM1555C2A9R1WA01#
				±0.1pF	GRM1555C2A9R1BA01#
				±0.25pF	GRM1555C2A9R1CA01#
			9.2pF	±0.05pF	GRM1555C2A9R2WA01#
				±0.1pF	GRM1555C2A9R2BA01#
				±0.25pF	GRM1555C2A9R2CA01#
			9.3pF	±0.05pF	GRM1555C2A9R3WA01#
				±0.1pF	GRM1555C2A9R3BA01#
				±0.25pF	GRM1555C2A9R3CA01#
			9.4pF	±0.05pF	GRM1555C2A9R4WA01#
				±0.1pF	GRM1555C2A9R4BA01#
				±0.25pF	GRM1555C2A9R4CA01#
			9.5pF	±0.05pF	GRM1555C2A9R5WA01#
				±0.1pF	GRM1555C2A9R5BA01#
				±0.25pF	GRM1555C2A9R5CA01#

品番 #には包装仕様コードが入ります。

GRMシリーズ
GJMシリーズ
GMAシリーズ
GMDシリーズ
GQMシリーズ
GRJシリーズ
GR3シリーズ
KRMシリーズ
KR3シリーズ
LLAシリーズ
LLLシリーズ
LLMシリーズ
LLRシリーズ
△注意/
使用上の注意

GRMシリーズ 温度補償用 品番表

(→ ■ 1.0×0.5mm)

T寸法 最大値	定格 電圧	温度 特性	静電容量	許容差	品番		
0.55mm	100Vdc	C0G	9.5pF	±0.5pF	GRM1555C2A9R5DA01#		
				9.6pF	±0.05pF	GRM1555C2A9R6WA01#	
					±0.1pF	GRM1555C2A9R6BA01#	
					±0.25pF	GRM1555C2A9R6CA01#	
					±0.5pF	GRM1555C2A9R6DA01#	
			9.7pF	±0.05pF	GRM1555C2A9R7WA01#		
				±0.1pF	GRM1555C2A9R7BA01#		
				±0.25pF	GRM1555C2A9R7CA01#		
				±0.5pF	GRM1555C2A9R7DA01#		
			9.8pF	±0.05pF	GRM1555C2A9R8WA01#		
				±0.1pF	GRM1555C2A9R8BA01#		
				±0.25pF	GRM1555C2A9R8CA01#		
				±0.5pF	GRM1555C2A9R8DA01#		
			9.9pF	±0.05pF	GRM1555C2A9R9WA01#		
				±0.1pF	GRM1555C2A9R9BA01#		
				±0.25pF	GRM1555C2A9R9CA01#		
				±0.5pF	GRM1555C2A9R9DA01#		
			10pF	±2%	GRM1555C2A100GA01#		
				±5%	GRM1555C2A100JA01#		
			12pF	±2%	GRM1555C2A120GA01#		
				±5%	GRM1555C2A120JA01#		
			15pF	±2%	GRM1555C2A150GA01#		
				±5%	GRM1555C2A150JA01#		
			18pF	±2%	GRM1555C2A180GA01#		
				±5%	GRM1555C2A180JA01#		
			22pF	±2%	GRM1555C2A220GA01#		
				±5%	GRM1555C2A220JA01#		
			27pF	±2%	GRM1555C2A270GA01#		
				±5%	GRM1555C2A270JA01#		
			33pF	±2%	GRM1555C2A330GA01#		
				±5%	GRM1555C2A330JA01#		
			39pF	±2%	GRM1555C2A390GA01#		
				±5%	GRM1555C2A390JA01#		
			47pF	±2%	GRM1555C2A470GA01#		
				±5%	GRM1555C2A470JA01#		
			56pF	±2%	GRM1555C2A560GA01#		
				±5%	GRM1555C2A560JA01#		
			68pF	±2%	GRM1555C2A680GA01#		
				±5%	GRM1555C2A680JA01#		
			82pF	±2%	GRM1555C2A820GA01#		
				±5%	GRM1555C2A820JA01#		
			100pF	±2%	GRM1555C2A101GA01#		
				±5%	GRM1555C2A101JA01#		
			50Vdc	CK	0.10pF	±0.05pF	GRM1554C1HR10WA01#
						±0.1pF	GRM1554C1HR20BA01#
					0.20pF	±0.05pF	GRM1554C1HR20WA01#
						±0.1pF	GRM1554C1HR20BA01#
					0.30pF	±0.05pF	GRM1554C1HR30WA01#
						±0.1pF	GRM1554C1HR30BA01#
					0.40pF	±0.05pF	GRM1554C1HR40WA01#
						±0.1pF	GRM1554C1HR40BA01#
					0.50pF	±0.05pF	GRM1554C1HR50WA01#
±0.1pF	GRM1554C1HR50BA01#						
0.60pF	±0.05pF	GRM1554C1HR60WA01#					
	±0.1pF	GRM1554C1HR60BA01#					

T寸法 最大値	定格 電圧	温度 特性	静電容量	許容差	品番
0.55mm	50Vdc	CK	0.70pF	±0.05pF	GRM1554C1HR70WA01#
				±0.1pF	GRM1554C1HR70BA01#
			0.80pF	±0.05pF	GRM1554C1HR80WA01#
				±0.1pF	GRM1554C1HR80BA01#
			0.90pF	±0.05pF	GRM1554C1HR90WA01#
				±0.1pF	GRM1554C1HR90BA01#
			1.0pF	±0.05pF	GRM1554C1H1R0WA01#
				±0.1pF	GRM1554C1H1R0BA01#
				±0.25pF	GRM1554C1H1R0CA01#
			1.1pF	±0.05pF	GRM1554C1H1R1WA01#
				±0.1pF	GRM1554C1H1R1BA01#
				±0.25pF	GRM1554C1H1R1CA01#
			1.2pF	±0.05pF	GRM1554C1H1R2WA01#
				±0.1pF	GRM1554C1H1R2BA01#
				±0.25pF	GRM1554C1H1R2CA01#
			1.3pF	±0.05pF	GRM1554C1H1R3WA01#
				±0.1pF	GRM1554C1H1R3BA01#
				±0.25pF	GRM1554C1H1R3CA01#
			1.4pF	±0.05pF	GRM1554C1H1R4WA01#
				±0.1pF	GRM1554C1H1R4BA01#
				±0.25pF	GRM1554C1H1R4CA01#
			1.5pF	±0.05pF	GRM1554C1H1R5WA01#
				±0.1pF	GRM1554C1H1R5BA01#
				±0.25pF	GRM1554C1H1R5CA01#
			1.6pF	±0.05pF	GRM1554C1H1R6WA01#
				±0.1pF	GRM1554C1H1R6BA01#
				±0.25pF	GRM1554C1H1R6CA01#
			1.7pF	±0.05pF	GRM1554C1H1R7WA01#
				±0.1pF	GRM1554C1H1R7BA01#
				±0.25pF	GRM1554C1H1R7CA01#
			1.8pF	±0.05pF	GRM1554C1H1R8WA01#
				±0.1pF	GRM1554C1H1R8BA01#
				±0.25pF	GRM1554C1H1R8CA01#
			1.9pF	±0.05pF	GRM1554C1H1R9WA01#
				±0.1pF	GRM1554C1H1R9BA01#
				±0.25pF	GRM1554C1H1R9CA01#
		2.0pF	±0.05pF	GRM1554C1H2R0WA01#	
			±0.1pF	GRM1554C1H2R0BA01#	
			±0.25pF	GRM1554C1H2R0CA01#	
		CJ	2.1pF	±0.05pF	GRM1553C1H2R1WA01#
				±0.1pF	GRM1553C1H2R1BA01#
				±0.25pF	GRM1553C1H2R1CA01#
			2.2pF	±0.05pF	GRM1553C1H2R2WA01#
				±0.1pF	GRM1553C1H2R2BA01#
				±0.25pF	GRM1553C1H2R2CA01#
		2.3pF	±0.05pF	GRM1553C1H2R3WA01#	
			±0.1pF	GRM1553C1H2R3BA01#	
			±0.25pF	GRM1553C1H2R3CA01#	
		2.4pF	±0.05pF	GRM1553C1H2R4WA01#	
			±0.1pF	GRM1553C1H2R4BA01#	
			±0.25pF	GRM1553C1H2R4CA01#	
		2.5pF	±0.05pF	GRM1553C1H2R5WA01#	
±0.1pF	GRM1553C1H2R5BA01#				
±0.25pF	GRM1553C1H2R5CA01#				

品番 #には包装仕様コードが入ります。

GRMシリーズ
 GJMシリーズ
 GMAシリーズ
 GMDシリーズ
 GQMシリーズ
 GRJシリーズ
 GR3シリーズ
 KRMシリーズ
 KR3シリーズ
 LLAシリーズ
 LLLシリーズ
 LLMシリーズ
 LLRシリーズ
 △注意/
 使用上の注意

GRMシリーズ 温度補償用 品番表

(→ ■ 1.0×0.5mm)

T寸法 最大値	定格 電圧	温度 特性	静電容量	許容差	品番
0.55mm	50Vdc	CJ	2.6pF	±0.05pF	GRM1553C1H2R6WA01#
				±0.1pF	GRM1553C1H2R6BA01#
				±0.25pF	GRM1553C1H2R6CA01#
			2.7pF	±0.05pF	GRM1553C1H2R7WA01#
				±0.1pF	GRM1553C1H2R7BA01#
				±0.25pF	GRM1553C1H2R7CA01#
			2.8pF	±0.05pF	GRM1553C1H2R8WA01#
				±0.1pF	GRM1553C1H2R8BA01#
				±0.25pF	GRM1553C1H2R8CA01#
			2.9pF	±0.05pF	GRM1553C1H2R9WA01#
				±0.1pF	GRM1553C1H2R9BA01#
				±0.25pF	GRM1553C1H2R9CA01#
			3.0pF	±0.05pF	GRM1553C1H3R0WA01#
				±0.1pF	GRM1553C1H3R0BA01#
				±0.25pF	GRM1553C1H3R0CA01#
			3.1pF	±0.05pF	GRM1553C1H3R1WA01#
				±0.1pF	GRM1553C1H3R1BA01#
				±0.25pF	GRM1553C1H3R1CA01#
			3.2pF	±0.05pF	GRM1553C1H3R2WA01#
				±0.1pF	GRM1553C1H3R2BA01#
				±0.25pF	GRM1553C1H3R2CA01#
			3.3pF	±0.05pF	GRM1553C1H3R3WA01#
				±0.1pF	GRM1553C1H3R3BA01#
				±0.25pF	GRM1553C1H3R3CA01#
			3.4pF	±0.05pF	GRM1553C1H3R4WA01#
				±0.1pF	GRM1553C1H3R4BA01#
				±0.25pF	GRM1553C1H3R4CA01#
			3.5pF	±0.05pF	GRM1553C1H3R5WA01#
				±0.1pF	GRM1553C1H3R5BA01#
				±0.25pF	GRM1553C1H3R5CA01#
			3.6pF	±0.05pF	GRM1553C1H3R6WA01#
				±0.1pF	GRM1553C1H3R6BA01#
				±0.25pF	GRM1553C1H3R6CA01#
			3.7pF	±0.05pF	GRM1553C1H3R7WA01#
				±0.1pF	GRM1553C1H3R7BA01#
				±0.25pF	GRM1553C1H3R7CA01#
		3.8pF	±0.05pF	GRM1553C1H3R8WA01#	
			±0.1pF	GRM1553C1H3R8BA01#	
			±0.25pF	GRM1553C1H3R8CA01#	
		3.9pF	±0.05pF	GRM1553C1H3R9WA01#	
			±0.1pF	GRM1553C1H3R9BA01#	
			±0.25pF	GRM1553C1H3R9CA01#	
		CH	4.0pF	±0.05pF	GRM1552C1H4R0WA01#
				±0.1pF	GRM1552C1H4R0BA01#
				±0.25pF	GRM1552C1H4R0CA01#
			4.1pF	±0.05pF	GRM1552C1H4R1WA01#
				±0.1pF	GRM1552C1H4R1BA01#
				±0.25pF	GRM1552C1H4R1CA01#
4.2pF	±0.05pF		GRM1552C1H4R2WA01#		
	±0.1pF		GRM1552C1H4R2BA01#		
	±0.25pF		GRM1552C1H4R2CA01#		
4.3pF	±0.05pF		GRM1552C1H4R3WA01#		
	±0.1pF		GRM1552C1H4R3BA01#		
	±0.25pF		GRM1552C1H4R3CA01#		

T寸法 最大値	定格 電圧	温度 特性	静電容量	許容差	品番
0.55mm	50Vdc	CH	4.4pF	±0.05pF	GRM1552C1H4R4WA01#
				±0.1pF	GRM1552C1H4R4BA01#
				±0.25pF	GRM1552C1H4R4CA01#
			4.5pF	±0.05pF	GRM1552C1H4R5WA01#
				±0.1pF	GRM1552C1H4R5BA01#
				±0.25pF	GRM1552C1H4R5CA01#
			4.6pF	±0.05pF	GRM1552C1H4R6WA01#
				±0.1pF	GRM1552C1H4R6BA01#
				±0.25pF	GRM1552C1H4R6CA01#
			4.7pF	±0.05pF	GRM1552C1H4R7WA01#
				±0.1pF	GRM1552C1H4R7BA01#
				±0.25pF	GRM1552C1H4R7CA01#
			4.8pF	±0.05pF	GRM1552C1H4R8WA01#
				±0.1pF	GRM1552C1H4R8BA01#
				±0.25pF	GRM1552C1H4R8CA01#
			4.9pF	±0.05pF	GRM1552C1H4R9WA01#
				±0.1pF	GRM1552C1H4R9BA01#
				±0.25pF	GRM1552C1H4R9CA01#
			5.0pF	±0.05pF	GRM1552C1H5R0WA01#
				±0.1pF	GRM1552C1H5R0BA01#
				±0.25pF	GRM1552C1H5R0CA01#
			5.1pF	±0.05pF	GRM1552C1H5R1WA01#
				±0.1pF	GRM1552C1H5R1BA01#
				±0.25pF	GRM1552C1H5R1CA01#
			5.2pF	±0.05pF	GRM1552C1H5R2WA01#
				±0.1pF	GRM1552C1H5R2BA01#
				±0.25pF	GRM1552C1H5R2CA01#
			5.3pF	±0.05pF	GRM1552C1H5R3WA01#
				±0.1pF	GRM1552C1H5R3BA01#
				±0.25pF	GRM1552C1H5R3CA01#
			5.4pF	±0.05pF	GRM1552C1H5R4WA01#
				±0.1pF	GRM1552C1H5R4BA01#
				±0.25pF	GRM1552C1H5R4CA01#
			5.5pF	±0.05pF	GRM1552C1H5R5WA01#
				±0.1pF	GRM1552C1H5R5BA01#
				±0.25pF	GRM1552C1H5R5CA01#
		5.6pF	±0.05pF	GRM1552C1H5R6WA01#	
			±0.1pF	GRM1552C1H5R6BA01#	
			±0.25pF	GRM1552C1H5R6CA01#	
		5.7pF	±0.05pF	GRM1552C1H5R7WA01#	
			±0.1pF	GRM1552C1H5R7BA01#	
			±0.25pF	GRM1552C1H5R7CA01#	
		5.8pF	±0.05pF	GRM1552C1H5R8WA01#	
			±0.1pF	GRM1552C1H5R8BA01#	
			±0.25pF	GRM1552C1H5R8CA01#	
		5.9pF	±0.05pF	GRM1552C1H5R9WA01#	
			±0.1pF	GRM1552C1H5R9BA01#	
			±0.25pF	GRM1552C1H5R9CA01#	

品番 #には包装仕様コードが入ります。

GRMシリーズ
GJMシリーズ
GMAシリーズ
GMDシリーズ
GQMシリーズ
GRJシリーズ
GR3シリーズ
KRMシリーズ
KR3シリーズ
LLAシリーズ
LLLシリーズ
LLMシリーズ
LLRシリーズ
△注意/
使用上の注意

GRMシリーズ 温度補償用 品番表

(→ ■ 1.0×0.5mm)

T寸法 最大値	定格 電圧	温度 特性	静電容量	許容差	品番
0.55mm	50Vdc	CH	5.9pF	±0.1pF	GRM1552C1H5R9BA01#
				±0.25pF	GRM1552C1H5R9CA01#
				±0.5pF	GRM1552C1H5R9DA01#
			6.0pF	±0.05pF	GRM1552C1H6R0WA01#
				±0.1pF	GRM1552C1H6R0BA01#
				±0.25pF	GRM1552C1H6R0CA01#
			6.1pF	±0.05pF	GRM1552C1H6R1WA01#
				±0.1pF	GRM1552C1H6R1BA01#
				±0.25pF	GRM1552C1H6R1CA01#
			6.2pF	±0.05pF	GRM1552C1H6R2WA01#
				±0.1pF	GRM1552C1H6R2BA01#
				±0.25pF	GRM1552C1H6R2CA01#
			6.3pF	±0.05pF	GRM1552C1H6R3WA01#
				±0.1pF	GRM1552C1H6R3BA01#
				±0.25pF	GRM1552C1H6R3CA01#
			6.4pF	±0.05pF	GRM1552C1H6R4WA01#
				±0.1pF	GRM1552C1H6R4BA01#
				±0.25pF	GRM1552C1H6R4CA01#
			6.5pF	±0.05pF	GRM1552C1H6R5WA01#
				±0.1pF	GRM1552C1H6R5BA01#
				±0.25pF	GRM1552C1H6R5CA01#
			6.6pF	±0.05pF	GRM1552C1H6R6WA01#
				±0.1pF	GRM1552C1H6R6BA01#
				±0.25pF	GRM1552C1H6R6CA01#
			6.7pF	±0.05pF	GRM1552C1H6R7WA01#
				±0.1pF	GRM1552C1H6R7BA01#
				±0.25pF	GRM1552C1H6R7CA01#
			6.8pF	±0.05pF	GRM1552C1H6R8WA01#
				±0.1pF	GRM1552C1H6R8BA01#
				±0.25pF	GRM1552C1H6R8CA01#
			6.9pF	±0.05pF	GRM1552C1H6R9WA01#
				±0.1pF	GRM1552C1H6R9BA01#
				±0.25pF	GRM1552C1H6R9CA01#
			7.0pF	±0.05pF	GRM1552C1H7R0WA01#
				±0.1pF	GRM1552C1H7R0BA01#
				±0.25pF	GRM1552C1H7R0CA01#
			7.1pF	±0.05pF	GRM1552C1H7R1WA01#
				±0.1pF	GRM1552C1H7R1BA01#
				±0.25pF	GRM1552C1H7R1CA01#
			7.2pF	±0.05pF	GRM1552C1H7R2WA01#
				±0.1pF	GRM1552C1H7R2BA01#
				±0.25pF	GRM1552C1H7R2CA01#

T寸法 最大値	定格 電圧	温度 特性	静電容量	許容差	品番
0.55mm	50Vdc	CH	7.2pF	±0.5pF	GRM1552C1H7R2DA01#
				±0.05pF	GRM1552C1H7R3WA01#
				±0.1pF	GRM1552C1H7R3BA01#
			7.3pF	±0.25pF	GRM1552C1H7R3CA01#
				±0.5pF	GRM1552C1H7R3DA01#
				7.4pF	±0.05pF
			±0.1pF		GRM1552C1H7R4BA01#
			±0.25pF		GRM1552C1H7R4CA01#
			7.5pF	±0.05pF	GRM1552C1H7R5WA01#
				±0.1pF	GRM1552C1H7R5BA01#
				±0.25pF	GRM1552C1H7R5CA01#
			7.6pF	±0.05pF	GRM1552C1H7R6WA01#
				±0.1pF	GRM1552C1H7R6BA01#
				±0.25pF	GRM1552C1H7R6CA01#
			7.7pF	±0.05pF	GRM1552C1H7R7WA01#
				±0.1pF	GRM1552C1H7R7BA01#
				±0.25pF	GRM1552C1H7R7CA01#
			7.8pF	±0.05pF	GRM1552C1H7R8WA01#
				±0.1pF	GRM1552C1H7R8BA01#
				±0.25pF	GRM1552C1H7R8CA01#
			7.9pF	±0.05pF	GRM1552C1H7R9WA01#
				±0.1pF	GRM1552C1H7R9BA01#
				±0.25pF	GRM1552C1H7R9CA01#
			8.0pF	±0.05pF	GRM1552C1H8R0WA01#
				±0.1pF	GRM1552C1H8R0BA01#
				±0.25pF	GRM1552C1H8R0CA01#
			8.1pF	±0.05pF	GRM1552C1H8R1WA01#
				±0.1pF	GRM1552C1H8R1BA01#
				±0.25pF	GRM1552C1H8R1CA01#
			8.2pF	±0.05pF	GRM1552C1H8R2WA01#
				±0.1pF	GRM1552C1H8R2BA01#
				±0.25pF	GRM1552C1H8R2CA01#
			8.3pF	±0.05pF	GRM1552C1H8R3WA01#
				±0.1pF	GRM1552C1H8R3BA01#
				±0.25pF	GRM1552C1H8R3CA01#
			8.4pF	±0.05pF	GRM1552C1H8R4WA01#
				±0.1pF	GRM1552C1H8R4BA01#
				±0.25pF	GRM1552C1H8R4CA01#
			8.5pF	±0.05pF	GRM1552C1H8R5WA01#
				±0.1pF	GRM1552C1H8R5BA01#
				±0.25pF	GRM1552C1H8R5CA01#
			8.6pF	±0.05pF	GRM1552C1H8R6WA01#
				±0.1pF	GRM1552C1H8R6BA01#
				±0.25pF	GRM1552C1H8R6CA01#

品番 #には包装仕様コードが入ります。

GRMシリーズ
 GJMシリーズ
 GMAシリーズ
 GMDシリーズ
 GQMシリーズ
 GRJシリーズ
 GR3シリーズ
 KRMシリーズ
 KR3シリーズ
 LLAシリーズ
 LLLシリーズ
 LLMシリーズ
 LLRシリーズ
 △注意/
 使用上の注意

GRMシリーズ 温度補償用 品番表

(→ ■ 1.0×0.5mm)

T寸法 最大値	定格 電圧	温度 特性	静電容量	許容差	品番
0.55mm	50Vdc	CH	8.6pF	±0.1pF	GRM1552C1H8R6BA01#
				±0.25pF	GRM1552C1H8R6CA01#
				±0.5pF	GRM1552C1H8R6DA01#
			8.7pF	±0.05pF	GRM1552C1H8R7WA01#
				±0.1pF	GRM1552C1H8R7BA01#
				±0.25pF	GRM1552C1H8R7CA01#
			8.8pF	±0.05pF	GRM1552C1H8R8WA01#
				±0.1pF	GRM1552C1H8R8BA01#
				±0.25pF	GRM1552C1H8R8CA01#
			8.9pF	±0.05pF	GRM1552C1H8R9WA01#
				±0.1pF	GRM1552C1H8R9BA01#
				±0.25pF	GRM1552C1H8R9CA01#
			9.0pF	±0.05pF	GRM1552C1H9R0WA01#
				±0.1pF	GRM1552C1H9R0BA01#
				±0.25pF	GRM1552C1H9R0CA01#
			9.1pF	±0.05pF	GRM1552C1H9R1WA01#
				±0.1pF	GRM1552C1H9R1BA01#
				±0.25pF	GRM1552C1H9R1CA01#
			9.2pF	±0.05pF	GRM1552C1H9R2WA01#
				±0.1pF	GRM1552C1H9R2BA01#
				±0.25pF	GRM1552C1H9R2CA01#
			9.3pF	±0.05pF	GRM1552C1H9R3WA01#
				±0.1pF	GRM1552C1H9R3BA01#
				±0.25pF	GRM1552C1H9R3CA01#
			9.4pF	±0.05pF	GRM1552C1H9R4WA01#
				±0.1pF	GRM1552C1H9R4BA01#
				±0.25pF	GRM1552C1H9R4CA01#
			9.5pF	±0.05pF	GRM1552C1H9R5WA01#
				±0.1pF	GRM1552C1H9R5BA01#
				±0.25pF	GRM1552C1H9R5CA01#
			9.6pF	±0.05pF	GRM1552C1H9R6WA01#
				±0.1pF	GRM1552C1H9R6BA01#
				±0.25pF	GRM1552C1H9R6CA01#
			9.7pF	±0.05pF	GRM1552C1H9R7WA01#
				±0.1pF	GRM1552C1H9R7BA01#
				±0.25pF	GRM1552C1H9R7CA01#
			9.8pF	±0.05pF	GRM1552C1H9R8WA01#
				±0.1pF	GRM1552C1H9R8BA01#
				±0.25pF	GRM1552C1H9R8CA01#
			9.9pF	±0.05pF	GRM1552C1H9R9WA01#
				±0.1pF	GRM1552C1H9R9BA01#
				±0.25pF	GRM1552C1H9R9CA01#

T寸法 最大値	定格 電圧	温度 特性	静電容量	許容差	品番
0.55mm	50Vdc	CH	9.9pF	±0.5pF	GRM1552C1H9R9DA01#
				±2%	GRM1552C1H100GA01#
			10pF	±5%	GRM1552C1H100JA01#
				±2%	GRM1552C1H120GA01#
			12pF	±5%	GRM1552C1H120JA01#
				±2%	GRM1552C1H150GA01#
			15pF	±5%	GRM1552C1H150JA01#
				±2%	GRM1552C1H180GA01#
			18pF	±5%	GRM1552C1H180JA01#
				±2%	GRM1552C1H220GA01#
			22pF	±5%	GRM1552C1H220JA01#
				±2%	GRM1552C1H270GA01#
			27pF	±5%	GRM1552C1H270JA01#
				±2%	GRM1552C1H330GA01#
			33pF	±5%	GRM1552C1H330JA01#
				±2%	GRM1552C1H390GA01#
			39pF	±5%	GRM1552C1H390JA01#
				±2%	GRM1552C1H470GA01#
			47pF	±5%	GRM1552C1H470JA01#
				±2%	GRM1552C1H560GA01#
			56pF	±5%	GRM1552C1H560JA01#
				±2%	GRM1552C1H680GA01#
			68pF	±5%	GRM1552C1H680JA01#
				±2%	GRM1552C1H820GA01#
			82pF	±5%	GRM1552C1H820JA01#
				±2%	GRM1552C1H101GA01#
			100pF	±5%	GRM1552C1H101JA01#
				±2%	GRM1552C1H121GA01#
			120pF	±5%	GRM1552C1H121JA01#
				±2%	GRM1552C1H151GA01#
			150pF	±5%	GRM1552C1H151JA01#
				±2%	GRM1552C1H181GA01#
			180pF	±5%	GRM1552C1H181JA01#
				±2%	GRM1552C1H221GA01#
			220pF	±5%	GRM1552C1H221JA01#
				±2%	GRM1552C1H271GA01#
			270pF	±5%	GRM1552C1H271JA01#
				±2%	GRM1552C1H331GA01#
			330pF	±5%	GRM1552C1H331JA01#
				±2%	GRM1552C1H391GA01#
			390pF	±5%	GRM1552C1H391JA01#
				±2%	GRM1552C1H471GA01#
470pF	±5%	GRM1552C1H471JA01#			
	±2%	GRM1552C1H561GA01#			
560pF	±5%	GRM1552C1H561JA01#			
	±2%	GRM1552C1H681GA01#			
680pF	±5%	GRM1552C1H681JA01#			
	±2%	GRM1552C1H821GA01#			
820pF	±5%	GRM1552C1H821JA01#			
	±2%	GRM1552C1H102GA01#			
1000pF	±5%	GRM1552C1H102JA01#			
	COG	±0.05pF	GRM1555C1HR10WA01#		
0.10pF	±0.05pF	GRM1555C1HR20WA01#			
	±0.1pF	GRM1555C1HR20BA01#			

品番 #には包装仕様コードが入ります。

GRMシリーズ 温度補償用 品番表

(→ ■ 1.0×0.5mm)

T寸法 最大値	定格 電圧	温度 特性	静電容量	許容差	品番
0.55mm	50Vdc	C0G	0.30pF	±0.05pF	GRM1555C1HR30WA01#
				±0.1pF	GRM1555C1HR30BA01#
			0.40pF	±0.05pF	GRM1555C1HR40WA01#
				±0.1pF	GRM1555C1HR40BA01#
			0.50pF	±0.05pF	GRM1555C1HR50WA01#
				±0.1pF	GRM1555C1HR50BA01#
			0.60pF	±0.05pF	GRM1555C1HR60WA01#
				±0.1pF	GRM1555C1HR60BA01#
			0.70pF	±0.05pF	GRM1555C1HR70WA01#
				±0.1pF	GRM1555C1HR70BA01#
			0.80pF	±0.05pF	GRM1555C1HR80WA01#
				±0.1pF	GRM1555C1HR80BA01#
			0.90pF	±0.05pF	GRM1555C1HR90WA01#
				±0.1pF	GRM1555C1HR90BA01#
			1.0pF	±0.05pF	GRM1555C1H1R0WA01#
				±0.1pF	GRM1555C1H1R0BA01#
				±0.25pF	GRM1555C1H1R0CA01#
			1.1pF	±0.05pF	GRM1555C1H1R1WA01#
				±0.1pF	GRM1555C1H1R1BA01#
				±0.25pF	GRM1555C1H1R1CA01#
			1.2pF	±0.05pF	GRM1555C1H1R2WA01#
				±0.1pF	GRM1555C1H1R2BA01#
				±0.25pF	GRM1555C1H1R2CA01#
			1.3pF	±0.05pF	GRM1555C1H1R3WA01#
				±0.1pF	GRM1555C1H1R3BA01#
				±0.25pF	GRM1555C1H1R3CA01#
			1.4pF	±0.05pF	GRM1555C1H1R4WA01#
				±0.1pF	GRM1555C1H1R4BA01#
				±0.25pF	GRM1555C1H1R4CA01#
			1.5pF	±0.05pF	GRM1555C1H1R5WA01#
				±0.1pF	GRM1555C1H1R5BA01#
				±0.25pF	GRM1555C1H1R5CA01#
			1.6pF	±0.05pF	GRM1555C1H1R6WA01#
				±0.1pF	GRM1555C1H1R6BA01#
				±0.25pF	GRM1555C1H1R6CA01#
			1.7pF	±0.05pF	GRM1555C1H1R7WA01#
±0.1pF	GRM1555C1H1R7BA01#				
±0.25pF	GRM1555C1H1R7CA01#				
1.8pF	±0.05pF	GRM1555C1H1R8WA01#			
	±0.1pF	GRM1555C1H1R8BA01#			
	±0.25pF	GRM1555C1H1R8CA01#			
1.9pF	±0.05pF	GRM1555C1H1R9WA01#			
	±0.1pF	GRM1555C1H1R9BA01#			
	±0.25pF	GRM1555C1H1R9CA01#			
2.0pF	±0.05pF	GRM1555C1H2R0WA01#			
	±0.1pF	GRM1555C1H2R0BA01#			
	±0.25pF	GRM1555C1H2R0CA01#			
2.1pF	±0.05pF	GRM1555C1H2R1WA01#			
	±0.1pF	GRM1555C1H2R1BA01#			
	±0.25pF	GRM1555C1H2R1CA01#			
2.2pF	±0.05pF	GRM1555C1H2R2WA01#			
	±0.1pF	GRM1555C1H2R2BA01#			
	±0.25pF	GRM1555C1H2R2CA01#			
2.3pF	±0.05pF	GRM1555C1H2R3WA01#			

T寸法 最大値	定格 電圧	温度 特性	静電容量	許容差	品番
0.55mm	50Vdc	C0G	2.3pF	±0.1pF	GRM1555C1H2R3BA01#
				±0.25pF	GRM1555C1H2R3CA01#
			2.4pF	±0.05pF	GRM1555C1H2R4WA01#
				±0.1pF	GRM1555C1H2R4BA01#
			2.5pF	±0.05pF	GRM1555C1H2R5WA01#
				±0.1pF	GRM1555C1H2R5BA01#
			2.6pF	±0.05pF	GRM1555C1H2R6WA01#
				±0.1pF	GRM1555C1H2R6BA01#
			2.7pF	±0.05pF	GRM1555C1H2R7WA01#
				±0.1pF	GRM1555C1H2R7BA01#
			2.8pF	±0.05pF	GRM1555C1H2R8WA01#
				±0.1pF	GRM1555C1H2R8BA01#
			2.9pF	±0.05pF	GRM1555C1H2R9WA01#
				±0.1pF	GRM1555C1H2R9BA01#
			3.0pF	±0.05pF	GRM1555C1H3R0WA01#
				±0.1pF	GRM1555C1H3R0BA01#
				±0.25pF	GRM1555C1H3R0CA01#
			3.1pF	±0.05pF	GRM1555C1H3R1WA01#
				±0.1pF	GRM1555C1H3R1BA01#
				±0.25pF	GRM1555C1H3R1CA01#
			3.2pF	±0.05pF	GRM1555C1H3R2WA01#
				±0.1pF	GRM1555C1H3R2BA01#
				±0.25pF	GRM1555C1H3R2CA01#
			3.3pF	±0.05pF	GRM1555C1H3R3WA01#
				±0.1pF	GRM1555C1H3R3BA01#
				±0.25pF	GRM1555C1H3R3CA01#
			3.4pF	±0.05pF	GRM1555C1H3R4WA01#
				±0.1pF	GRM1555C1H3R4BA01#
				±0.25pF	GRM1555C1H3R4CA01#
			3.5pF	±0.05pF	GRM1555C1H3R5WA01#
				±0.1pF	GRM1555C1H3R5BA01#
				±0.25pF	GRM1555C1H3R5CA01#
			3.6pF	±0.05pF	GRM1555C1H3R6WA01#
				±0.1pF	GRM1555C1H3R6BA01#
				±0.25pF	GRM1555C1H3R6CA01#
			3.7pF	±0.05pF	GRM1555C1H3R7WA01#
±0.1pF	GRM1555C1H3R7BA01#				
±0.25pF	GRM1555C1H3R7CA01#				
3.8pF	±0.05pF	GRM1555C1H3R8WA01#			
	±0.1pF	GRM1555C1H3R8BA01#			
	±0.25pF	GRM1555C1H3R8CA01#			
3.9pF	±0.05pF	GRM1555C1H3R9WA01#			
	±0.1pF	GRM1555C1H3R9BA01#			
	±0.25pF	GRM1555C1H3R9CA01#			
4.0pF	±0.05pF	GRM1555C1H4R0WA01#			
	±0.1pF	GRM1555C1H4R0BA01#			
	±0.25pF	GRM1555C1H4R0CA01#			
4.1pF	±0.05pF	GRM1555C1H4R1WA01#			

品番 #には包装仕様コードが入ります。

GRMシリーズ
 GJMシリーズ
 GMAシリーズ
 GMDシリーズ
 GQMシリーズ
 GRJシリーズ
 GR3シリーズ
 KRMシリーズ
 KR3シリーズ
 LLAシリーズ
 LLLシリーズ
 LLMシリーズ
 LLRシリーズ
 △注意/
 使用上の注意

GRMシリーズ 温度補償用 品番表

(→ ■ 1.0×0.5mm)

T寸法 最大値	定格 電圧	温度 特性	静電容量	許容差	品番
0.55mm	50Vdc	COG	4.1pF	±0.1pF	GRM1555C1H4R1BA01#
				±0.25pF	GRM1555C1H4R1CA01#
			4.2pF	±0.05pF	GRM1555C1H4R2WA01#
				±0.1pF	GRM1555C1H4R2BA01#
			4.3pF	±0.25pF	GRM1555C1H4R2CA01#
				±0.05pF	GRM1555C1H4R3WA01#
			4.4pF	±0.1pF	GRM1555C1H4R3BA01#
				±0.25pF	GRM1555C1H4R3CA01#
				±0.05pF	GRM1555C1H4R4WA01#
			4.5pF	±0.1pF	GRM1555C1H4R4BA01#
				±0.25pF	GRM1555C1H4R4CA01#
				±0.05pF	GRM1555C1H4R5WA01#
			4.6pF	±0.1pF	GRM1555C1H4R5BA01#
				±0.25pF	GRM1555C1H4R5CA01#
				±0.05pF	GRM1555C1H4R6WA01#
			4.7pF	±0.1pF	GRM1555C1H4R6BA01#
				±0.25pF	GRM1555C1H4R6CA01#
				±0.05pF	GRM1555C1H4R7WA01#
			4.8pF	±0.1pF	GRM1555C1H4R7BA01#
				±0.25pF	GRM1555C1H4R7CA01#
				±0.05pF	GRM1555C1H4R8WA01#
			4.9pF	±0.1pF	GRM1555C1H4R8BA01#
				±0.25pF	GRM1555C1H4R8CA01#
				±0.05pF	GRM1555C1H4R9WA01#
			5.0pF	±0.1pF	GRM1555C1H4R9BA01#
				±0.25pF	GRM1555C1H4R9CA01#
				±0.05pF	GRM1555C1H5R0WA01#
			5.1pF	±0.1pF	GRM1555C1H5R0BA01#
				±0.25pF	GRM1555C1H5R0CA01#
				±0.05pF	GRM1555C1H5R1WA01#
			5.2pF	±0.1pF	GRM1555C1H5R1BA01#
				±0.25pF	GRM1555C1H5R1CA01#
				±0.5pF	GRM1555C1H5R1DA01#
				±0.05pF	GRM1555C1H5R2WA01#
			5.3pF	±0.1pF	GRM1555C1H5R2BA01#
				±0.25pF	GRM1555C1H5R2CA01#
				±0.5pF	GRM1555C1H5R2DA01#
				±0.05pF	GRM1555C1H5R3WA01#
			5.4pF	±0.1pF	GRM1555C1H5R3BA01#
				±0.25pF	GRM1555C1H5R3CA01#
				±0.5pF	GRM1555C1H5R3DA01#
				±0.05pF	GRM1555C1H5R4WA01#
			5.5pF	±0.1pF	GRM1555C1H5R4BA01#
				±0.25pF	GRM1555C1H5R4CA01#
				±0.5pF	GRM1555C1H5R4DA01#
				±0.05pF	GRM1555C1H5R5WA01#
			5.6pF	±0.1pF	GRM1555C1H5R5BA01#
				±0.25pF	GRM1555C1H5R5CA01#
				±0.5pF	GRM1555C1H5R5DA01#
				±0.05pF	GRM1555C1H5R6WA01#
			5.7pF	±0.1pF	GRM1555C1H5R6BA01#
				±0.25pF	GRM1555C1H5R6CA01#
				±0.5pF	GRM1555C1H5R6DA01#
				±0.05pF	GRM1555C1H5R7WA01#

T寸法 最大値	定格 電圧	温度 特性	静電容量	許容差	品番
0.55mm	50Vdc	COG	5.7pF	±0.1pF	GRM1555C1H5R7BA01#
				±0.25pF	GRM1555C1H5R7CA01#
				±0.5pF	GRM1555C1H5R7DA01#
			5.8pF	±0.05pF	GRM1555C1H5R8WA01#
				±0.1pF	GRM1555C1H5R8BA01#
				±0.25pF	GRM1555C1H5R8CA01#
			5.9pF	±0.5pF	GRM1555C1H5R8DA01#
				±0.05pF	GRM1555C1H5R9WA01#
				±0.1pF	GRM1555C1H5R9BA01#
			6.0pF	±0.25pF	GRM1555C1H5R9CA01#
				±0.5pF	GRM1555C1H5R9DA01#
				±0.05pF	GRM1555C1H6R0WA01#
			6.1pF	±0.1pF	GRM1555C1H6R0BA01#
				±0.25pF	GRM1555C1H6R0CA01#
				±0.5pF	GRM1555C1H6R0DA01#
			6.2pF	±0.05pF	GRM1555C1H6R1WA01#
				±0.1pF	GRM1555C1H6R1BA01#
				±0.25pF	GRM1555C1H6R1CA01#
			6.3pF	±0.5pF	GRM1555C1H6R1DA01#
				±0.05pF	GRM1555C1H6R2WA01#
				±0.1pF	GRM1555C1H6R2BA01#
			6.4pF	±0.25pF	GRM1555C1H6R2CA01#
				±0.5pF	GRM1555C1H6R2DA01#
				±0.05pF	GRM1555C1H6R3WA01#
			6.5pF	±0.1pF	GRM1555C1H6R3BA01#
				±0.25pF	GRM1555C1H6R3CA01#
				±0.5pF	GRM1555C1H6R3DA01#
			6.6pF	±0.05pF	GRM1555C1H6R4WA01#
				±0.1pF	GRM1555C1H6R4BA01#
				±0.25pF	GRM1555C1H6R4CA01#
			6.7pF	±0.5pF	GRM1555C1H6R4DA01#
				±0.05pF	GRM1555C1H6R5WA01#
				±0.1pF	GRM1555C1H6R5BA01#
			6.8pF	±0.25pF	GRM1555C1H6R5CA01#
				±0.5pF	GRM1555C1H6R5DA01#
				±0.05pF	GRM1555C1H6R6WA01#
			6.9pF	±0.1pF	GRM1555C1H6R6BA01#
				±0.25pF	GRM1555C1H6R6CA01#
				±0.5pF	GRM1555C1H6R6DA01#
			7.0pF	±0.05pF	GRM1555C1H6R7WA01#
				±0.1pF	GRM1555C1H6R7BA01#
				±0.25pF	GRM1555C1H6R7CA01#
			7.1pF	±0.5pF	GRM1555C1H6R7DA01#
				±0.05pF	GRM1555C1H6R8WA01#
				±0.1pF	GRM1555C1H6R8BA01#
			7.2pF	±0.25pF	GRM1555C1H6R8CA01#
				±0.5pF	GRM1555C1H6R8DA01#
				±0.05pF	GRM1555C1H6R9WA01#
			7.3pF	±0.1pF	GRM1555C1H6R9BA01#
				±0.25pF	GRM1555C1H6R9CA01#
				±0.5pF	GRM1555C1H6R9DA01#
			7.4pF	±0.05pF	GRM1555C1H7R0WA01#
				±0.1pF	GRM1555C1H7R0BA01#
				±0.25pF	GRM1555C1H7R0CA01#

品番 #には包装仕様コードが入ります。

GRMシリーズ
GJMシリーズ
GMAシリーズ
GMDシリーズ
GQMシリーズ
GRJシリーズ
GRSシリーズ
KRMシリーズ
KR3シリーズ
LLAシリーズ
LLLシリーズ
LLMシリーズ
LLRシリーズ
△注意/
使用上の注意

GRMシリーズ 温度補償用 品番表

(→ ■ 1.0×0.5mm)

T寸法 最大値	定格 電圧	温度 特性	静電容量	許容差	品番
0.55mm	50Vdc	C0G	7.0pF	±0.5pF	GRM1555C1H7R0DA01#
				±0.05pF	GRM1555C1H7R1WA01#
					±0.1pF
			±0.25pF		GRM1555C1H7R1CA01#
			7.1pF	±0.5pF	GRM1555C1H7R1DA01#
				±0.05pF	GRM1555C1H7R2WA01#
					±0.1pF
			±0.25pF		GRM1555C1H7R2CA01#
			7.2pF	±0.5pF	GRM1555C1H7R2DA01#
				±0.05pF	GRM1555C1H7R3WA01#
					±0.1pF
			±0.25pF		GRM1555C1H7R3CA01#
			7.3pF	±0.5pF	GRM1555C1H7R3DA01#
				±0.05pF	GRM1555C1H7R4WA01#
					±0.1pF
			±0.25pF		GRM1555C1H7R4CA01#
			7.4pF	±0.5pF	GRM1555C1H7R4DA01#
				±0.05pF	GRM1555C1H7R5WA01#
					±0.1pF
			±0.25pF		GRM1555C1H7R5CA01#
			7.5pF	±0.5pF	GRM1555C1H7R5DA01#
				±0.05pF	GRM1555C1H7R6WA01#
					±0.1pF
			±0.25pF		GRM1555C1H7R6CA01#
			7.6pF	±0.5pF	GRM1555C1H7R6DA01#
				±0.05pF	GRM1555C1H7R7WA01#
					±0.1pF
			±0.25pF		GRM1555C1H7R7CA01#
			7.7pF	±0.5pF	GRM1555C1H7R7DA01#
				±0.05pF	GRM1555C1H7R8WA01#
					±0.1pF
			±0.25pF		GRM1555C1H7R8CA01#
			7.8pF	±0.5pF	GRM1555C1H7R8DA01#
				±0.05pF	GRM1555C1H7R9WA01#
					±0.1pF
			±0.25pF		GRM1555C1H7R9CA01#
			7.9pF	±0.5pF	GRM1555C1H7R9DA01#
				±0.05pF	GRM1555C1H8R0WA01#
					±0.1pF
			±0.25pF		GRM1555C1H8R0CA01#
			8.0pF	±0.5pF	GRM1555C1H8R0DA01#
				±0.05pF	GRM1555C1H8R1WA01#
					±0.1pF
			±0.25pF		GRM1555C1H8R1CA01#
			8.1pF	±0.5pF	GRM1555C1H8R1DA01#
				±0.05pF	GRM1555C1H8R2WA01#
					±0.1pF
			±0.25pF		GRM1555C1H8R2CA01#
8.2pF	±0.5pF	GRM1555C1H8R2DA01#			
	±0.05pF	GRM1555C1H8R3WA01#			
		±0.1pF	GRM1555C1H8R3BA01#		
±0.25pF		GRM1555C1H8R3CA01#			
8.3pF	±0.5pF	GRM1555C1H8R3DA01#			
	±0.05pF	GRM1555C1H8R4WA01#			

T寸法 最大値	定格 電圧	温度 特性	静電容量	許容差	品番
0.55mm	50Vdc	C0G	8.4pF	±0.1pF	GRM1555C1H8R4BA01#
				±0.25pF	GRM1555C1H8R4CA01#
				±0.5pF	GRM1555C1H8R4DA01#
			8.5pF	±0.05pF	GRM1555C1H8R5WA01#
				±0.1pF	GRM1555C1H8R5BA01#
				±0.25pF	GRM1555C1H8R5CA01#
			8.6pF	±0.5pF	GRM1555C1H8R5DA01#
				±0.05pF	GRM1555C1H8R6WA01#
					±0.1pF
			±0.25pF		GRM1555C1H8R6CA01#
			8.7pF	±0.5pF	GRM1555C1H8R6DA01#
				±0.05pF	GRM1555C1H8R7WA01#
					±0.1pF
			±0.25pF		GRM1555C1H8R7CA01#
			8.8pF	±0.5pF	GRM1555C1H8R7DA01#
				±0.05pF	GRM1555C1H8R8WA01#
					±0.1pF
			±0.25pF		GRM1555C1H8R8CA01#
			8.9pF	±0.5pF	GRM1555C1H8R8DA01#
				±0.05pF	GRM1555C1H8R9WA01#
					±0.1pF
			±0.25pF		GRM1555C1H8R9CA01#
			9.0pF	±0.5pF	GRM1555C1H8R9DA01#
				±0.05pF	GRM1555C1H9R0WA01#
					±0.1pF
			±0.25pF		GRM1555C1H9R0CA01#
			9.1pF	±0.5pF	GRM1555C1H9R0DA01#
				±0.05pF	GRM1555C1H9R1WA01#
					±0.1pF
			±0.25pF		GRM1555C1H9R1CA01#
			9.2pF	±0.5pF	GRM1555C1H9R1DA01#
				±0.05pF	GRM1555C1H9R2WA01#
					±0.1pF
			±0.25pF		GRM1555C1H9R2CA01#
			9.3pF	±0.5pF	GRM1555C1H9R2DA01#
				±0.05pF	GRM1555C1H9R3WA01#
					±0.1pF
			±0.25pF		GRM1555C1H9R3CA01#
			9.4pF	±0.5pF	GRM1555C1H9R3DA01#
				±0.05pF	GRM1555C1H9R4WA01#
					±0.1pF
			±0.25pF		GRM1555C1H9R4CA01#
			9.5pF	±0.5pF	GRM1555C1H9R4DA01#
				±0.05pF	GRM1555C1H9R5WA01#
					±0.1pF
			±0.25pF		GRM1555C1H9R5CA01#
			9.6pF	±0.5pF	GRM1555C1H9R5DA01#
				±0.05pF	GRM1555C1H9R6WA01#
±0.1pF	GRM1555C1H9R6BA01#				
±0.25pF	GRM1555C1H9R6CA01#				
9.7pF	±0.5pF	GRM1555C1H9R6DA01#			
	±0.05pF	GRM1555C1H9R7WA01#			
		±0.1pF	GRM1555C1H9R7BA01#		
±0.25pF		GRM1555C1H9R7CA01#			

品番 #には包装仕様コードが入ります。

- GRMシリーズ
- GJMシリーズ
- GMAシリーズ
- GMDシリーズ
- GQMシリーズ
- GRJシリーズ
- GR3シリーズ
- KRMシリーズ
- KR3シリーズ
- LLAシリーズ
- LLLシリーズ
- LLMシリーズ
- LLRシリーズ
- △注意/
使用上の注意

GRMシリーズ 温度補償用 品番表

(→ ■ 1.0×0.5mm)

T寸法 最大値	定格 電圧	温度 特性	静電容量	許容差	品番
0.55mm	50Vdc	COG	9.7pF	±0.5pF	GRM1555C1H9R7DA01#
				±0.05pF	GRM1555C1H9R8WA01#
			9.8pF	±0.1pF	GRM1555C1H9R8BA01#
				±0.25pF	GRM1555C1H9R8CA01#
				±0.5pF	GRM1555C1H9R8DA01#
				9.9pF	±0.05pF
			±0.1pF		GRM1555C1H9R9BA01#
			±0.25pF		GRM1555C1H9R9CA01#
			±0.5pF		GRM1555C1H9R9DA01#
			10pF	±2%	GRM1555C1H100GA01#
				±5%	GRM1555C1H100JA01#
			12pF	±2%	GRM1555C1H120GA01#
				±5%	GRM1555C1H120JA01#
			15pF	±2%	GRM1555C1H150GA01#
				±5%	GRM1555C1H150JA01#
			18pF	±2%	GRM1555C1H180GA01#
				±5%	GRM1555C1H180JA01#
			22pF	±2%	GRM1555C1H220GA01#
				±5%	GRM1555C1H220JA01#
			27pF	±2%	GRM1555C1H270GA01#
				±5%	GRM1555C1H270JA01#
			33pF	±2%	GRM1555C1H330GA01#
				±5%	GRM1555C1H330JA01#
			39pF	±2%	GRM1555C1H390GA01#
				±5%	GRM1555C1H390JA01#
			47pF	±2%	GRM1555C1H470GA01#
				±5%	GRM1555C1H470JA01#
			56pF	±2%	GRM1555C1H560GA01#
				±5%	GRM1555C1H560JA01#
			68pF	±2%	GRM1555C1H680GA01#
				±5%	GRM1555C1H680JA01#
			82pF	±2%	GRM1555C1H820GA01#
				±5%	GRM1555C1H820JA01#
			100pF	±2%	GRM1555C1H101GA01#
				±5%	GRM1555C1H101JA01#
			120pF	±2%	GRM1555C1H121GA01#
				±5%	GRM1555C1H121JA01#
			150pF	±2%	GRM1555C1H151GA01#
				±5%	GRM1555C1H151JA01#
			180pF	±2%	GRM1555C1H181GA01#
				±5%	GRM1555C1H181JA01#
			220pF	±2%	GRM1555C1H221GA01#
				±5%	GRM1555C1H221JA01#
			270pF	±2%	GRM1555C1H271GA01#
				±5%	GRM1555C1H271JA01#
			330pF	±2%	GRM1555C1H331GA01#
				±5%	GRM1555C1H331JA01#
			390pF	±2%	GRM1555C1H391GA01#
±5%	GRM1555C1H391JA01#				
470pF	±2%	GRM1555C1H471GA01#			
	±5%	GRM1555C1H471JA01#			
560pF	±2%	GRM1555C1H561GA01#			
	±5%	GRM1555C1H561JA01#			
680pF	±2%	GRM1555C1H681GA01#			

T寸法 最大値	定格 電圧	温度 特性	静電容量	許容差	品番		
0.55mm	50Vdc	COG	680pF	±5%	GRM1555C1H681JA01#		
				±2%	GRM1555C1H821GA01#		
			820pF	±5%	GRM1555C1H821JA01#		
				±2%	GRM1555C1H102GA01#		
			1000pF	±5%	GRM1555C1H102JA01#		
				10Vdc	SL	1200pF	±5%
			1500pF			±5%	GRM1551X1A152JA01#
			1800pF			±5%	GRM1551X1A182JA01#
			2200pF			±5%	GRM1551X1A222JA01#
			2700pF			±5%	GRM1551X1A272JA01#
			3300pF			±5%	GRM1551X1A332JA01#
			UU		3900pF	±5%	GRM1551X1A392JA01#
		4700pF			±5%	GRM1551X1A472JA01#	
		U2J			1200pF	±5%	GRM1553U1A122JA01#
					1500pF	±5%	GRM1553U1A152JA01#
					1800pF	±5%	GRM1553U1A182JA01#
					2200pF	±5%	GRM1553U1A222JA01#
			2700pF	±5%	GRM1553U1A272JA01#		
			3300pF	±5%	GRM1553U1A332JA01#		
		10Vdc	UU	3900pF	±5%	GRM1553U1A392JA01#	
				4700pF	±5%	GRM1553U1A472JA01#	
				U2J	1200pF	±5%	GRM1557U1A122JA01#
					1500pF	±5%	GRM1557U1A152JA01#
					1800pF	±5%	GRM1557U1A182JA01#
	2200pF				±5%	GRM1557U1A222JA01#	
	2700pF		±5%		GRM1557U1A272JA01#		
	3300pF		±5%		GRM1557U1A332JA01#		
	UU		3900pF	±5%	GRM1557U1A392JA01#		
			4700pF	±5%	GRM1557U1A472JA01#		

■ 1.6×0.8mm

T寸法 最大値	定格 電圧	温度 特性	静電容量	許容差	品番		
0.5mm	50Vdc	SL	2200pF	±5%	GRM1851X1H222JA44#		
				±5%	GRM1851X1H272JA44#		
			2700pF	±5%	GRM1851X1H332JA44#		
				±5%	GRM1851X1H392JA44#		
			3900pF	±5%	GRM1851X1H472JA44#		
				UU	2200pF	±5%	GRM1853U1H222JA44#
			2700pF		±5%	GRM1853U1H272JA44#	
			3300pF		±5%	GRM1853U1H332JA44#	
			3900pF		±5%	GRM1853U1H392JA44#	
			4700pF		±5%	GRM1853U1H472JA44#	
			U2J		2200pF	±5%	GRM1857U1H222JA44#
				2700pF	±5%	GRM1857U1H272JA44#	
		3300pF		±5%	GRM1857U1H332JA44#		
		3900pF		±5%	GRM1857U1H392JA44#		
		4700pF		±5%	GRM1857U1H472JA44#		
		10Vdc		SL	5600pF	±5%	GRM1851X1A562JA44#
			6800pF		±5%	GRM1851X1A682JA44#	
			8200pF		±5%	GRM1851X1A822JA44#	
			10000pF		±5%	GRM1851X1A103JA44#	
			UU		5600pF	±5%	GRM1853U1A562JA44#

品番 #には包装仕様コードが入ります。

GRMシリーズ
GJMシリーズ
GMAシリーズ
GMDシリーズ
GQMシリーズ
GRJシリーズ
GR3シリーズ
KRMシリーズ
KR3シリーズ
LLAシリーズ
LLLシリーズ
LLMシリーズ
LLRシリーズ
△注意/
使用上の注意

GRMシリーズ 温度補償用 品番表

(→ ■ 1.6×0.8mm)

T寸法 最大値	定格 電圧	温度 特性	静電容量	許容差	品番			
0.5mm	10Vdc	UJ	6800pF	±5%	GRM1853U1A682JA44#			
				±5%	GRM1853U1A822JA44#			
				±5%	GRM1853U1A103JA44#			
			U2J	5600pF	±5%	GRM1857U1A562JA44#		
					±5%	GRM1857U1A682JA44#		
					±5%	GRM1857U1A822JA44#		
		10000pF		±5%	GRM1857U1A103JA44#			
				±5%	GRM1857U1A103JA44#			
				±5%	GRM1857U1A103JA44#			
			0.9mm	100Vdc	CK	0.50pF	±0.05pF	GRM1884C2AR50WA01#
							±0.1pF	GRM1884C2AR50BA01#
							±0.25pF	GRM1884C2AR50CA01#
0.60pF	±0.05pF	GRM1884C2AR60WA01#						
	±0.1pF	GRM1884C2AR60BA01#						
	±0.25pF	GRM1884C2AR60CA01#						
0.70pF	±0.05pF	GRM1884C2AR70WA01#						
	±0.1pF	GRM1884C2AR70BA01#						
	±0.25pF	GRM1884C2AR70CA01#						
0.80pF	±0.05pF	GRM1884C2AR80WA01#						
	±0.1pF	GRM1884C2AR80BA01#						
	±0.25pF	GRM1884C2AR80CA01#						
0.90pF	±0.05pF	GRM1884C2AR90WA01#						
	±0.1pF	GRM1884C2AR90BA01#						
	±0.25pF	GRM1884C2AR90CA01#						
1.0pF	±0.05pF	GRM1884C2A1R0WA01#						
	±0.1pF	GRM1884C2A1R0BA01#						
	±0.25pF	GRM1884C2A1R0CA01#						
1.1pF	±0.05pF	GRM1884C2A1R1WA01#						
	±0.1pF	GRM1884C2A1R1BA01#						
	±0.25pF	GRM1884C2A1R1CA01#						
1.2pF	±0.05pF	GRM1884C2A1R2WA01#						
	±0.1pF	GRM1884C2A1R2BA01#						
	±0.25pF	GRM1884C2A1R2CA01#						
1.3pF	±0.05pF	GRM1884C2A1R3WA01#						
	±0.1pF	GRM1884C2A1R3BA01#						
	±0.25pF	GRM1884C2A1R3CA01#						
1.4pF	±0.05pF	GRM1884C2A1R4WA01#						
	±0.1pF	GRM1884C2A1R4BA01#						
	±0.25pF	GRM1884C2A1R4CA01#						
1.5pF	±0.05pF	GRM1884C2A1R5WA01#						
	±0.1pF	GRM1884C2A1R5BA01#						
	±0.25pF	GRM1884C2A1R5CA01#						
1.6pF	±0.05pF	GRM1884C2A1R6WA01#						
	±0.1pF	GRM1884C2A1R6BA01#						
	±0.25pF	GRM1884C2A1R6CA01#						
1.7pF	±0.05pF	GRM1884C2A1R7WA01#						
	±0.1pF	GRM1884C2A1R7BA01#						
	±0.25pF	GRM1884C2A1R7CA01#						
1.8pF	±0.05pF	GRM1884C2A1R8WA01#						
	±0.1pF	GRM1884C2A1R8BA01#						
	±0.25pF	GRM1884C2A1R8CA01#						
1.9pF	±0.05pF	GRM1884C2A1R9WA01#						
	±0.1pF	GRM1884C2A1R9BA01#						
	±0.25pF	GRM1884C2A1R9CA01#						
2.0pF	±0.05pF	GRM1884C2A2R0WA01#						
	±0.1pF	GRM1884C2A2R0BA01#						
	±0.25pF	GRM1884C2A2R0CA01#						
CJ	2.1pF	±0.05pF	GRM1883C2A2R1WA01#					
		±0.1pF	GRM1883C2A2R1BA01#					
		±0.25pF	GRM1883C2A2R1CA01#					
	2.2pF	±0.05pF	GRM1883C2A2R2WA01#					
		±0.1pF	GRM1883C2A2R2BA01#					
		±0.25pF	GRM1883C2A2R2CA01#					

T寸法 最大値	定格 電圧	温度 特性	静電容量	許容差	品番
0.9mm	100Vdc	CJ	2.2pF	±0.1pF	GRM1883C2A2R2BA01#
				±0.25pF	GRM1883C2A2R2CA01#
				±0.05pF	GRM1883C2A2R3WA01#
			2.3pF	±0.1pF	GRM1883C2A2R3BA01#
				±0.25pF	GRM1883C2A2R3CA01#
				±0.05pF	GRM1883C2A2R4WA01#
			2.4pF	±0.1pF	GRM1883C2A2R4BA01#
				±0.25pF	GRM1883C2A2R4CA01#
				±0.05pF	GRM1883C2A2R5WA01#
			2.5pF	±0.1pF	GRM1883C2A2R5BA01#
				±0.25pF	GRM1883C2A2R5CA01#
				±0.05pF	GRM1883C2A2R6WA01#
			2.6pF	±0.1pF	GRM1883C2A2R6BA01#
				±0.25pF	GRM1883C2A2R6CA01#
				±0.05pF	GRM1883C2A2R7WA01#
			2.7pF	±0.1pF	GRM1883C2A2R7BA01#
				±0.25pF	GRM1883C2A2R7CA01#
				±0.05pF	GRM1883C2A2R8WA01#
			2.8pF	±0.1pF	GRM1883C2A2R8BA01#
				±0.25pF	GRM1883C2A2R8CA01#
				±0.05pF	GRM1883C2A2R9WA01#
			2.9pF	±0.1pF	GRM1883C2A2R9BA01#
				±0.25pF	GRM1883C2A2R9CA01#
				±0.05pF	GRM1883C2A3R0WA01#
3.0pF	±0.1pF	GRM1883C2A3R0BA01#			
	±0.25pF	GRM1883C2A3R0CA01#			
	±0.05pF	GRM1883C2A3R1WA01#			
3.1pF	±0.1pF	GRM1883C2A3R1BA01#			
	±0.25pF	GRM1883C2A3R1CA01#			
	±0.05pF	GRM1883C2A3R2WA01#			
3.2pF	±0.1pF	GRM1883C2A3R2BA01#			
	±0.25pF	GRM1883C2A3R2CA01#			
	±0.05pF	GRM1883C2A3R3WA01#			
3.3pF	±0.1pF	GRM1883C2A3R3BA01#			
	±0.25pF	GRM1883C2A3R3CA01#			
	±0.05pF	GRM1883C2A3R4WA01#			
3.4pF	±0.1pF	GRM1883C2A3R4BA01#			
	±0.25pF	GRM1883C2A3R4CA01#			
	±0.05pF	GRM1883C2A3R5WA01#			
3.5pF	±0.1pF	GRM1883C2A3R5BA01#			
	±0.25pF	GRM1883C2A3R5CA01#			
	±0.05pF	GRM1883C2A3R6WA01#			
3.6pF	±0.1pF	GRM1883C2A3R6BA01#			
	±0.25pF	GRM1883C2A3R6CA01#			
	±0.05pF	GRM1883C2A3R7WA01#			
3.7pF	±0.1pF	GRM1883C2A3R7BA01#			
	±0.25pF	GRM1883C2A3R7CA01#			
	±0.05pF	GRM1883C2A3R8WA01#			
3.8pF	±0.1pF	GRM1883C2A3R8BA01#			
	±0.25pF	GRM1883C2A3R8CA01#			
	±0.05pF	GRM1883C2A3R9WA01#			
3.9pF	±0.1pF	GRM1883C2A3R9BA01#			
	±0.25pF	GRM1883C2A3R9CA01#			
	CH	4.0pF	±0.05pF	GRM1882C2A4R0WA01#	

品番 #には包装仕様コードが入ります。

GRMシリーズ
 GJMシリーズ
 GMAシリーズ
 GMDシリーズ
 GQMシリーズ
 GRJシリーズ
 GR3シリーズ
 KRMシリーズ
 KR3シリーズ
 LLAシリーズ
 LLLシリーズ
 LLMシリーズ
 LLRシリーズ
 △注意/
 使用上の注意

GRMシリーズ 温度補償用 品番表

(→ ■ 1.6×0.8mm)

T寸法 最大値	定格 電圧	温度 特性	静電容量	許容差	品番
0.9mm	100Vdc	CH	4.0pF	±0.1pF	GRM1882C2A4R0BA01#
				±0.25pF	GRM1882C2A4R0CA01#
			4.1pF	±0.05pF	GRM1882C2A4R1WA01#
				±0.1pF	GRM1882C2A4R1BA01#
				±0.25pF	GRM1882C2A4R1CA01#
			4.2pF	±0.05pF	GRM1882C2A4R2WA01#
				±0.1pF	GRM1882C2A4R2BA01#
				±0.25pF	GRM1882C2A4R2CA01#
			4.3pF	±0.05pF	GRM1882C2A4R3WA01#
				±0.1pF	GRM1882C2A4R3BA01#
				±0.25pF	GRM1882C2A4R3CA01#
			4.4pF	±0.05pF	GRM1882C2A4R4WA01#
				±0.1pF	GRM1882C2A4R4BA01#
				±0.25pF	GRM1882C2A4R4CA01#
			4.5pF	±0.05pF	GRM1882C2A4R5WA01#
				±0.1pF	GRM1882C2A4R5BA01#
				±0.25pF	GRM1882C2A4R5CA01#
			4.6pF	±0.05pF	GRM1882C2A4R6WA01#
				±0.1pF	GRM1882C2A4R6BA01#
				±0.25pF	GRM1882C2A4R6CA01#
			4.7pF	±0.05pF	GRM1882C2A4R7WA01#
				±0.1pF	GRM1882C2A4R7BA01#
				±0.25pF	GRM1882C2A4R7CA01#
			4.8pF	±0.05pF	GRM1882C2A4R8WA01#
				±0.1pF	GRM1882C2A4R8BA01#
				±0.25pF	GRM1882C2A4R8CA01#
			4.9pF	±0.05pF	GRM1882C2A4R9WA01#
				±0.1pF	GRM1882C2A4R9BA01#
				±0.25pF	GRM1882C2A4R9CA01#
			5.0pF	±0.05pF	GRM1882C2A5R0WA01#
				±0.1pF	GRM1882C2A5R0BA01#
				±0.25pF	GRM1882C2A5R0CA01#
			5.1pF	±0.05pF	GRM1882C2A5R1WA01#
				±0.1pF	GRM1882C2A5R1BA01#
				±0.25pF	GRM1882C2A5R1CA01#
				±0.5pF	GRM1882C2A5R1DA01#
			5.2pF	±0.05pF	GRM1882C2A5R2WA01#
				±0.1pF	GRM1882C2A5R2BA01#
				±0.25pF	GRM1882C2A5R2CA01#
				±0.5pF	GRM1882C2A5R2DA01#
			5.3pF	±0.05pF	GRM1882C2A5R3WA01#
				±0.1pF	GRM1882C2A5R3BA01#
				±0.25pF	GRM1882C2A5R3CA01#
				±0.5pF	GRM1882C2A5R3DA01#
			5.4pF	±0.05pF	GRM1882C2A5R4WA01#
				±0.1pF	GRM1882C2A5R4BA01#
				±0.25pF	GRM1882C2A5R4CA01#
				±0.5pF	GRM1882C2A5R4DA01#
			5.5pF	±0.05pF	GRM1882C2A5R5WA01#
				±0.1pF	GRM1882C2A5R5BA01#
				±0.25pF	GRM1882C2A5R5CA01#
				±0.5pF	GRM1882C2A5R5DA01#
			5.6pF	±0.05pF	GRM1882C2A5R6WA01#
				±0.1pF	GRM1882C2A5R6BA01#

T寸法 最大値	定格 電圧	温度 特性	静電容量	許容差	品番
0.9mm	100Vdc	CH	5.6pF	±0.25pF	GRM1882C2A5R6CA01#
				±0.5pF	GRM1882C2A5R6DA01#
			5.7pF	±0.05pF	GRM1882C2A5R7WA01#
				±0.1pF	GRM1882C2A5R7BA01#
				±0.25pF	GRM1882C2A5R7CA01#
				±0.5pF	GRM1882C2A5R7DA01#
			5.8pF	±0.05pF	GRM1882C2A5R8WA01#
				±0.1pF	GRM1882C2A5R8BA01#
				±0.25pF	GRM1882C2A5R8CA01#
				±0.5pF	GRM1882C2A5R8DA01#
			5.9pF	±0.05pF	GRM1882C2A5R9WA01#
				±0.1pF	GRM1882C2A5R9BA01#
				±0.25pF	GRM1882C2A5R9CA01#
				±0.5pF	GRM1882C2A5R9DA01#
			6.0pF	±0.05pF	GRM1882C2A6R0WA01#
				±0.1pF	GRM1882C2A6R0BA01#
				±0.25pF	GRM1882C2A6R0CA01#
				±0.5pF	GRM1882C2A6R0DA01#
			6.1pF	±0.05pF	GRM1882C2A6R1WA01#
				±0.1pF	GRM1882C2A6R1BA01#
				±0.25pF	GRM1882C2A6R1CA01#
				±0.5pF	GRM1882C2A6R1DA01#
			6.2pF	±0.05pF	GRM1882C2A6R2WA01#
				±0.1pF	GRM1882C2A6R2BA01#
				±0.25pF	GRM1882C2A6R2CA01#
				±0.5pF	GRM1882C2A6R2DA01#
			6.3pF	±0.05pF	GRM1882C2A6R3WA01#
				±0.1pF	GRM1882C2A6R3BA01#
				±0.25pF	GRM1882C2A6R3CA01#
				±0.5pF	GRM1882C2A6R3DA01#
			6.4pF	±0.05pF	GRM1882C2A6R4WA01#
				±0.1pF	GRM1882C2A6R4BA01#
				±0.25pF	GRM1882C2A6R4CA01#
				±0.5pF	GRM1882C2A6R4DA01#
			6.5pF	±0.05pF	GRM1882C2A6R5WA01#
				±0.1pF	GRM1882C2A6R5BA01#
				±0.25pF	GRM1882C2A6R5CA01#
				±0.5pF	GRM1882C2A6R5DA01#
			6.6pF	±0.05pF	GRM1882C2A6R6WA01#
				±0.1pF	GRM1882C2A6R6BA01#
				±0.25pF	GRM1882C2A6R6CA01#
				±0.5pF	GRM1882C2A6R6DA01#
			6.7pF	±0.05pF	GRM1882C2A6R7WA01#
				±0.1pF	GRM1882C2A6R7BA01#
				±0.25pF	GRM1882C2A6R7CA01#
				±0.5pF	GRM1882C2A6R7DA01#
			6.8pF	±0.05pF	GRM1882C2A6R8WA01#
				±0.1pF	GRM1882C2A6R8BA01#
				±0.25pF	GRM1882C2A6R8CA01#
				±0.5pF	GRM1882C2A6R8DA01#
			6.9pF	±0.05pF	GRM1882C2A6R9WA01#
				±0.1pF	GRM1882C2A6R9BA01#
				±0.25pF	GRM1882C2A6R9CA01#
				±0.5pF	GRM1882C2A6R9DA01#

品番 #には包装仕様コードが入ります。

GRMシリーズ
GJMシリーズ
GMAシリーズ
GMDシリーズ
GQMシリーズ
GRJシリーズ
GR3シリーズ
KRMシリーズ
KR3シリーズ
LLAシリーズ
LLLシリーズ
LLMシリーズ
LLRシリーズ
△注意/
使用上の注意

GRMシリーズ 温度補償用 品番表

(→ ■ 1.6×0.8mm)

T寸法 最大値	定格 電圧	温度 特性	静電容量	許容差	品番
0.9mm	100Vdc	CH	7.0pF	±0.05pF	GRM1882C2A7R0WA01#
				±0.1pF	GRM1882C2A7R0BA01#
				±0.25pF	GRM1882C2A7R0CA01#
				±0.5pF	GRM1882C2A7R0DA01#
			7.1pF	±0.05pF	GRM1882C2A7R1WA01#
				±0.1pF	GRM1882C2A7R1BA01#
				±0.25pF	GRM1882C2A7R1CA01#
				±0.5pF	GRM1882C2A7R1DA01#
			7.2pF	±0.05pF	GRM1882C2A7R2WA01#
				±0.1pF	GRM1882C2A7R2BA01#
				±0.25pF	GRM1882C2A7R2CA01#
				±0.5pF	GRM1882C2A7R2DA01#
			7.3pF	±0.05pF	GRM1882C2A7R3WA01#
				±0.1pF	GRM1882C2A7R3BA01#
				±0.25pF	GRM1882C2A7R3CA01#
				±0.5pF	GRM1882C2A7R3DA01#
			7.4pF	±0.05pF	GRM1882C2A7R4WA01#
				±0.1pF	GRM1882C2A7R4BA01#
				±0.25pF	GRM1882C2A7R4CA01#
				±0.5pF	GRM1882C2A7R4DA01#
			7.5pF	±0.05pF	GRM1882C2A7R5WA01#
				±0.1pF	GRM1882C2A7R5BA01#
				±0.25pF	GRM1882C2A7R5CA01#
				±0.5pF	GRM1882C2A7R5DA01#
			7.6pF	±0.05pF	GRM1882C2A7R6WA01#
				±0.1pF	GRM1882C2A7R6BA01#
				±0.25pF	GRM1882C2A7R6CA01#
				±0.5pF	GRM1882C2A7R6DA01#
			7.7pF	±0.05pF	GRM1882C2A7R7WA01#
				±0.1pF	GRM1882C2A7R7BA01#
				±0.25pF	GRM1882C2A7R7CA01#
				±0.5pF	GRM1882C2A7R7DA01#
			7.8pF	±0.05pF	GRM1882C2A7R8WA01#
				±0.1pF	GRM1882C2A7R8BA01#
				±0.25pF	GRM1882C2A7R8CA01#
				±0.5pF	GRM1882C2A7R8DA01#
			7.9pF	±0.05pF	GRM1882C2A7R9WA01#
				±0.1pF	GRM1882C2A7R9BA01#
				±0.25pF	GRM1882C2A7R9CA01#
				±0.5pF	GRM1882C2A7R9DA01#
			8.0pF	±0.05pF	GRM1882C2A8R0WA01#
				±0.1pF	GRM1882C2A8R0BA01#
				±0.25pF	GRM1882C2A8R0CA01#
				±0.5pF	GRM1882C2A8R0DA01#
			8.1pF	±0.05pF	GRM1882C2A8R1WA01#
				±0.1pF	GRM1882C2A8R1BA01#
				±0.25pF	GRM1882C2A8R1CA01#
				±0.5pF	GRM1882C2A8R1DA01#
8.2pF	±0.05pF	GRM1882C2A8R2WA01#			
	±0.1pF	GRM1882C2A8R2BA01#			
	±0.25pF	GRM1882C2A8R2CA01#			
	±0.5pF	GRM1882C2A8R2DA01#			
8.3pF	±0.05pF	GRM1882C2A8R3WA01#			
	±0.1pF	GRM1882C2A8R3BA01#			

T寸法 最大値	定格 電圧	温度 特性	静電容量	許容差	品番
0.9mm	100Vdc	CH	8.3pF	±0.25pF	GRM1882C2A8R3CA01#
				±0.5pF	GRM1882C2A8R3DA01#
			8.4pF	±0.05pF	GRM1882C2A8R4WA01#
				±0.1pF	GRM1882C2A8R4BA01#
				±0.25pF	GRM1882C2A8R4CA01#
			8.5pF	±0.05pF	GRM1882C2A8R5WA01#
				±0.1pF	GRM1882C2A8R5BA01#
				±0.25pF	GRM1882C2A8R5CA01#
			8.6pF	±0.05pF	GRM1882C2A8R6WA01#
				±0.1pF	GRM1882C2A8R6BA01#
				±0.25pF	GRM1882C2A8R6CA01#
			8.7pF	±0.05pF	GRM1882C2A8R7WA01#
				±0.1pF	GRM1882C2A8R7BA01#
				±0.25pF	GRM1882C2A8R7CA01#
			8.8pF	±0.05pF	GRM1882C2A8R8WA01#
				±0.1pF	GRM1882C2A8R8BA01#
				±0.25pF	GRM1882C2A8R8CA01#
			8.9pF	±0.05pF	GRM1882C2A8R9WA01#
				±0.1pF	GRM1882C2A8R9BA01#
				±0.25pF	GRM1882C2A8R9CA01#
			9.0pF	±0.05pF	GRM1882C2A9R0WA01#
				±0.1pF	GRM1882C2A9R0BA01#
				±0.25pF	GRM1882C2A9R0CA01#
			9.1pF	±0.05pF	GRM1882C2A9R1WA01#
				±0.1pF	GRM1882C2A9R1BA01#
				±0.25pF	GRM1882C2A9R1CA01#
			9.2pF	±0.05pF	GRM1882C2A9R2WA01#
				±0.1pF	GRM1882C2A9R2BA01#
				±0.25pF	GRM1882C2A9R2CA01#
			9.3pF	±0.05pF	GRM1882C2A9R3WA01#
				±0.1pF	GRM1882C2A9R3BA01#
				±0.25pF	GRM1882C2A9R3CA01#
			9.4pF	±0.05pF	GRM1882C2A9R4WA01#
				±0.1pF	GRM1882C2A9R4BA01#
				±0.25pF	GRM1882C2A9R4CA01#
			9.5pF	±0.05pF	GRM1882C2A9R5WA01#
				±0.1pF	GRM1882C2A9R5BA01#
				±0.25pF	GRM1882C2A9R5CA01#
			9.6pF	±0.05pF	GRM1882C2A9R6WA01#
				±0.1pF	GRM1882C2A9R6BA01#
				±0.25pF	GRM1882C2A9R6CA01#

品番 #には包装仕様コードが入ります。

GRMシリーズ
 GJMシリーズ
 GMAシリーズ
 GMDシリーズ
 GQMシリーズ
 GRJシリーズ
 GR3シリーズ
 KRMシリーズ
 KR3シリーズ
 LLAシリーズ
 LLLシリーズ
 LLMシリーズ
 LLRシリーズ
 △注意/
 使用上の注意

GRMシリーズ 温度補償用 品番表

(→ ■ 1.6×0.8mm)

T寸法 最大値	定格 電圧	温度 特性	静電容量	許容差	品番	
0.9mm	100Vdc	CH	9.7pF	±0.05pF	GRM1882C2A9R7WA01#	
				±0.1pF	GRM1882C2A9R7BA01#	
				±0.25pF	GRM1882C2A9R7CA01#	
				±0.5pF	GRM1882C2A9R7DA01#	
			9.8pF	±0.05pF	GRM1882C2A9R8WA01#	
				±0.1pF	GRM1882C2A9R8BA01#	
				±0.25pF	GRM1882C2A9R8CA01#	
				±0.5pF	GRM1882C2A9R8DA01#	
			9.9pF	±0.05pF	GRM1882C2A9R9WA01#	
				±0.1pF	GRM1882C2A9R9BA01#	
				±0.25pF	GRM1882C2A9R9CA01#	
				±0.5pF	GRM1882C2A9R9DA01#	
			10pF	±5%	GRM1882C2A100JA01#	
			12pF	±5%	GRM1882C2A120JA01#	
			15pF	±5%	GRM1882C2A150JA01#	
			18pF	±5%	GRM1882C2A180JA01#	
			22pF	±5%	GRM1882C2A220JA01#	
			27pF	±5%	GRM1882C2A270JA01#	
			33pF	±5%	GRM1882C2A330JA01#	
			39pF	±5%	GRM1882C2A390JA01#	
			47pF	±5%	GRM1882C2A470JA01#	
			56pF	±5%	GRM1882C2A560JA01#	
			68pF	±5%	GRM1882C2A680JA01#	
			82pF	±5%	GRM1882C2A820JA01#	
			100pF	±5%	GRM1882C2A101JA01#	
			120pF	±5%	GRM1882C2A121JA01#	
			150pF	±5%	GRM1882C2A151JA01#	
			180pF	±5%	GRM1882C2A181JA01#	
			220pF	±5%	GRM1882C2A221JA01#	
			270pF	±5%	GRM1882C2A271JA01#	
			330pF	±5%	GRM1882C2A331JA01#	
			390pF	±5%	GRM1882C2A391JA01#	
			470pF	±5%	GRM1882C2A471JA01#	
			560pF	±5%	GRM1882C2A561JA01#	
			680pF	±5%	GRM1882C2A681JA01#	
			820pF	±5%	GRM1882C2A821JA01#	
			1000pF	±5%	GRM1882C2A102JA01#	
			1200pF	±5%	GRM1882C2A122JA01#	
			1500pF	±5%	GRM1882C2A152JA01#	
			COG	0.50pF	±0.05pF	GRM1885C2AR50WA01#
					±0.1pF	GRM1885C2AR50BA01#
				0.60pF	±0.05pF	GRM1885C2AR60WA01#
					±0.1pF	GRM1885C2AR60BA01#
				0.70pF	±0.05pF	GRM1885C2AR70WA01#
					±0.1pF	GRM1885C2AR70BA01#
				0.80pF	±0.05pF	GRM1885C2AR80WA01#
					±0.1pF	GRM1885C2AR80BA01#
0.90pF	±0.05pF	GRM1885C2AR90WA01#				
	±0.1pF	GRM1885C2AR90BA01#				
1.0pF	±0.05pF	GRM1885C2A1R0WA01#				
	±0.1pF	GRM1885C2A1R0BA01#				
	±0.25pF	GRM1885C2A1R0CA01#				
1.1pF	±0.05pF	GRM1885C2A1R1WA01#				
	±0.1pF	GRM1885C2A1R1BA01#				

T寸法 最大値	定格 電圧	温度 特性	静電容量	許容差	品番
0.9mm	100Vdc	COG	1.1pF	±0.25pF	GRM1885C2A1R1CA01#
				±0.05pF	GRM1885C2A1R2WA01#
				±0.1pF	GRM1885C2A1R2BA01#
				±0.25pF	GRM1885C2A1R2CA01#
			1.2pF	±0.05pF	GRM1885C2A1R3WA01#
				±0.1pF	GRM1885C2A1R3BA01#
				±0.25pF	GRM1885C2A1R3CA01#
				±0.05pF	GRM1885C2A1R4WA01#
			1.3pF	±0.05pF	GRM1885C2A1R4BA01#
				±0.1pF	GRM1885C2A1R4CA01#
				±0.25pF	GRM1885C2A1R5WA01#
				±0.05pF	GRM1885C2A1R5BA01#
			1.4pF	±0.05pF	GRM1885C2A1R5CA01#
				±0.1pF	GRM1885C2A1R6WA01#
				±0.1pF	GRM1885C2A1R6BA01#
				±0.25pF	GRM1885C2A1R6CA01#
			1.5pF	±0.05pF	GRM1885C2A1R7WA01#
				±0.1pF	GRM1885C2A1R7BA01#
				±0.25pF	GRM1885C2A1R7CA01#
				±0.05pF	GRM1885C2A1R8WA01#
			1.6pF	±0.05pF	GRM1885C2A1R8BA01#
				±0.1pF	GRM1885C2A1R8CA01#
				±0.25pF	GRM1885C2A1R9WA01#
				±0.05pF	GRM1885C2A1R9BA01#
			1.7pF	±0.05pF	GRM1885C2A1R9CA01#
				±0.1pF	GRM1885C2A2R0WA01#
				±0.1pF	GRM1885C2A2R0BA01#
				±0.25pF	GRM1885C2A2R0CA01#
			1.8pF	±0.05pF	GRM1885C2A2R1WA01#
				±0.1pF	GRM1885C2A2R1BA01#
				±0.25pF	GRM1885C2A2R1CA01#
				±0.05pF	GRM1885C2A2R2WA01#
			1.9pF	±0.05pF	GRM1885C2A2R2BA01#
				±0.1pF	GRM1885C2A2R2CA01#
				±0.25pF	GRM1885C2A2R3WA01#
				±0.05pF	GRM1885C2A2R3BA01#
			2.0pF	±0.05pF	GRM1885C2A2R3CA01#
				±0.1pF	GRM1885C2A2R4WA01#
				±0.1pF	GRM1885C2A2R4BA01#
				±0.25pF	GRM1885C2A2R4CA01#
			2.1pF	±0.05pF	GRM1885C2A2R5WA01#
				±0.1pF	GRM1885C2A2R5BA01#
				±0.25pF	GRM1885C2A2R5CA01#
				±0.05pF	GRM1885C2A2R6WA01#
			2.2pF	±0.05pF	GRM1885C2A2R6BA01#
				±0.1pF	GRM1885C2A2R6CA01#
				±0.25pF	GRM1885C2A2R7WA01#
±0.05pF	GRM1885C2A2R7BA01#				
2.3pF	±0.05pF	GRM1885C2A2R7CA01#			
	±0.1pF	GRM1885C2A2R8WA01#			
	±0.1pF	GRM1885C2A2R8BA01#			
	±0.25pF	GRM1885C2A2R8CA01#			
2.4pF	±0.05pF	GRM1885C2A2R9WA01#			
	±0.1pF	GRM1885C2A2R9BA01#			
	±0.25pF	GRM1885C2A2R9CA01#			
	±0.05pF	GRM1885C2A2R9WA01#			
2.5pF	±0.05pF	GRM1885C2A2R9BA01#			
	±0.1pF	GRM1885C2A2R9CA01#			
	±0.25pF	GRM1885C2A2R9WA01#			
	±0.05pF	GRM1885C2A2R9BA01#			
2.6pF	±0.05pF	GRM1885C2A2R9CA01#			
	±0.1pF	GRM1885C2A2R9WA01#			
	±0.1pF	GRM1885C2A2R9BA01#			
	±0.25pF	GRM1885C2A2R9CA01#			
2.7pF	±0.05pF	GRM1885C2A2R9WA01#			
	±0.1pF	GRM1885C2A2R9BA01#			
	±0.25pF	GRM1885C2A2R9CA01#			
	±0.05pF	GRM1885C2A2R9WA01#			
2.8pF	±0.05pF	GRM1885C2A2R9BA01#			
	±0.1pF	GRM1885C2A2R9CA01#			
	±0.25pF	GRM1885C2A2R9WA01#			
	±0.05pF	GRM1885C2A2R9BA01#			
2.9pF	±0.05pF	GRM1885C2A2R9CA01#			
	±0.1pF	GRM1885C2A2R9WA01#			
	±0.1pF	GRM1885C2A2R9BA01#			
	±0.25pF	GRM1885C2A2R9CA01#			

品番 #には包装仕様コードが入ります。

GRMシリーズ
GJMシリーズ
GMAシリーズ
GMDシリーズ
GQMシリーズ
GRJシリーズ
GRSシリーズ
KRMシリーズ
KR3シリーズ
LLAシリーズ
LLLシリーズ
LLMシリーズ
LLRシリーズ
△注意/
使用上の注意

GRMシリーズ 温度補償用 品番表

(→ ■1.6×0.8mm)

T寸法 最大値	定格 電圧	温度 特性	静電容量	許容差	品番
0.9mm	100Vdc	C0G	2.9pF	±0.25pF	GRM1885C2A2R9CA01#
				±0.05pF	GRM1885C2A3R0WA01#
					±0.1pF
			±0.25pF		GRM1885C2A3R0CA01#
			3.1pF	±0.05pF	GRM1885C2A3R1WA01#
				±0.1pF	GRM1885C2A3R1BA01#
				±0.25pF	GRM1885C2A3R1CA01#
			3.2pF	±0.05pF	GRM1885C2A3R2WA01#
				±0.1pF	GRM1885C2A3R2BA01#
				±0.25pF	GRM1885C2A3R2CA01#
			3.3pF	±0.05pF	GRM1885C2A3R3WA01#
				±0.1pF	GRM1885C2A3R3BA01#
				±0.25pF	GRM1885C2A3R3CA01#
			3.4pF	±0.05pF	GRM1885C2A3R4WA01#
				±0.1pF	GRM1885C2A3R4BA01#
				±0.25pF	GRM1885C2A3R4CA01#
			3.5pF	±0.05pF	GRM1885C2A3R5WA01#
				±0.1pF	GRM1885C2A3R5BA01#
				±0.25pF	GRM1885C2A3R5CA01#
			3.6pF	±0.05pF	GRM1885C2A3R6WA01#
				±0.1pF	GRM1885C2A3R6BA01#
				±0.25pF	GRM1885C2A3R6CA01#
			3.7pF	±0.05pF	GRM1885C2A3R7WA01#
				±0.1pF	GRM1885C2A3R7BA01#
				±0.25pF	GRM1885C2A3R7CA01#
			3.8pF	±0.05pF	GRM1885C2A3R8WA01#
				±0.1pF	GRM1885C2A3R8BA01#
				±0.25pF	GRM1885C2A3R8CA01#
			3.9pF	±0.05pF	GRM1885C2A3R9WA01#
				±0.1pF	GRM1885C2A3R9BA01#
				±0.25pF	GRM1885C2A3R9CA01#
			4.0pF	±0.05pF	GRM1885C2A4R0WA01#
				±0.1pF	GRM1885C2A4R0BA01#
				±0.25pF	GRM1885C2A4R0CA01#
			4.1pF	±0.05pF	GRM1885C2A4R1WA01#
				±0.1pF	GRM1885C2A4R1BA01#
				±0.25pF	GRM1885C2A4R1CA01#
			4.2pF	±0.05pF	GRM1885C2A4R2WA01#
				±0.1pF	GRM1885C2A4R2BA01#
				±0.25pF	GRM1885C2A4R2CA01#
			4.3pF	±0.05pF	GRM1885C2A4R3WA01#
				±0.1pF	GRM1885C2A4R3BA01#
±0.25pF	GRM1885C2A4R3CA01#				
4.4pF	±0.05pF	GRM1885C2A4R4WA01#			
	±0.1pF	GRM1885C2A4R4BA01#			
	±0.25pF	GRM1885C2A4R4CA01#			
4.5pF	±0.05pF	GRM1885C2A4R5WA01#			
	±0.1pF	GRM1885C2A4R5BA01#			
	±0.25pF	GRM1885C2A4R5CA01#			
4.6pF	±0.05pF	GRM1885C2A4R6WA01#			
	±0.1pF	GRM1885C2A4R6BA01#			
	±0.25pF	GRM1885C2A4R6CA01#			
4.7pF	±0.05pF	GRM1885C2A4R7WA01#			
	±0.1pF	GRM1885C2A4R7BA01#			

T寸法 最大値	定格 電圧	温度 特性	静電容量	許容差	品番
0.9mm	100Vdc	C0G	4.7pF	±0.25pF	GRM1885C2A4R7CA01#
				±0.05pF	GRM1885C2A4R8WA01#
					±0.1pF
			±0.25pF		GRM1885C2A4R8CA01#
			4.9pF	±0.05pF	GRM1885C2A4R9WA01#
				±0.1pF	GRM1885C2A4R9BA01#
				±0.25pF	GRM1885C2A4R9CA01#
			5.0pF	±0.05pF	GRM1885C2A5R0WA01#
				±0.1pF	GRM1885C2A5R0BA01#
				±0.25pF	GRM1885C2A5R0CA01#
			5.1pF	±0.05pF	GRM1885C2A5R1WA01#
				±0.1pF	GRM1885C2A5R1BA01#
				±0.25pF	GRM1885C2A5R1CA01#
			5.2pF	±0.05pF	GRM1885C2A5R2WA01#
				±0.1pF	GRM1885C2A5R2BA01#
				±0.25pF	GRM1885C2A5R2CA01#
			5.3pF	±0.05pF	GRM1885C2A5R3WA01#
				±0.1pF	GRM1885C2A5R3BA01#
				±0.25pF	GRM1885C2A5R3CA01#
			5.4pF	±0.05pF	GRM1885C2A5R4WA01#
				±0.1pF	GRM1885C2A5R4BA01#
				±0.25pF	GRM1885C2A5R4CA01#
			5.5pF	±0.05pF	GRM1885C2A5R5WA01#
				±0.1pF	GRM1885C2A5R5BA01#
				±0.25pF	GRM1885C2A5R5CA01#
			5.6pF	±0.05pF	GRM1885C2A5R6WA01#
				±0.1pF	GRM1885C2A5R6BA01#
				±0.25pF	GRM1885C2A5R6CA01#
			5.7pF	±0.05pF	GRM1885C2A5R7WA01#
				±0.1pF	GRM1885C2A5R7BA01#
				±0.25pF	GRM1885C2A5R7CA01#
			5.8pF	±0.05pF	GRM1885C2A5R8WA01#
				±0.1pF	GRM1885C2A5R8BA01#
				±0.25pF	GRM1885C2A5R8CA01#
			5.9pF	±0.05pF	GRM1885C2A5R9WA01#
				±0.1pF	GRM1885C2A5R9BA01#
				±0.25pF	GRM1885C2A5R9CA01#
			6.0pF	±0.05pF	GRM1885C2A6R0WA01#
				±0.1pF	GRM1885C2A6R0BA01#
				±0.25pF	GRM1885C2A6R0CA01#
			6.1pF	±0.05pF	GRM1885C2A6R1WA01#
				±0.1pF	GRM1885C2A6R1BA01#
±0.25pF	GRM1885C2A6R1CA01#				

品番 #には包装仕様コードが入ります。

GRMシリーズ
 GJMシリーズ
 GMAシリーズ
 GMDシリーズ
 GQMシリーズ
 GRJシリーズ
 GR3シリーズ
 KRMシリーズ
 KR3シリーズ
 LLAシリーズ
 LLLシリーズ
 LLMシリーズ
 LLRシリーズ
 △注意/
 使用上の注意

GRMシリーズ 温度補償用 品番表

(→ ■ 1.6×0.8mm)

T寸法 最大値	定格 電圧	温度 特性	静電容量	許容差	品番
0.9mm	100Vdc	C0G	6.2pF	±0.05pF	GRM1885C2A6R2WA01#
				±0.1pF	GRM1885C2A6R2BA01#
				±0.25pF	GRM1885C2A6R2CA01#
				±0.5pF	GRM1885C2A6R2DA01#
			6.3pF	±0.05pF	GRM1885C2A6R3WA01#
				±0.1pF	GRM1885C2A6R3BA01#
				±0.25pF	GRM1885C2A6R3CA01#
				±0.5pF	GRM1885C2A6R3DA01#
			6.4pF	±0.05pF	GRM1885C2A6R4WA01#
				±0.1pF	GRM1885C2A6R4BA01#
				±0.25pF	GRM1885C2A6R4CA01#
				±0.5pF	GRM1885C2A6R4DA01#
			6.5pF	±0.05pF	GRM1885C2A6R5WA01#
				±0.1pF	GRM1885C2A6R5BA01#
				±0.25pF	GRM1885C2A6R5CA01#
				±0.5pF	GRM1885C2A6R5DA01#
			6.6pF	±0.05pF	GRM1885C2A6R6WA01#
				±0.1pF	GRM1885C2A6R6BA01#
				±0.25pF	GRM1885C2A6R6CA01#
				±0.5pF	GRM1885C2A6R6DA01#
			6.7pF	±0.05pF	GRM1885C2A6R7WA01#
				±0.1pF	GRM1885C2A6R7BA01#
				±0.25pF	GRM1885C2A6R7CA01#
				±0.5pF	GRM1885C2A6R7DA01#
			6.8pF	±0.05pF	GRM1885C2A6R8WA01#
				±0.1pF	GRM1885C2A6R8BA01#
				±0.25pF	GRM1885C2A6R8CA01#
				±0.5pF	GRM1885C2A6R8DA01#
			6.9pF	±0.05pF	GRM1885C2A6R9WA01#
				±0.1pF	GRM1885C2A6R9BA01#
				±0.25pF	GRM1885C2A6R9CA01#
				±0.5pF	GRM1885C2A6R9DA01#
			7.0pF	±0.05pF	GRM1885C2A7R0WA01#
				±0.1pF	GRM1885C2A7R0BA01#
				±0.25pF	GRM1885C2A7R0CA01#
				±0.5pF	GRM1885C2A7R0DA01#
			7.1pF	±0.05pF	GRM1885C2A7R1WA01#
				±0.1pF	GRM1885C2A7R1BA01#
				±0.25pF	GRM1885C2A7R1CA01#
				±0.5pF	GRM1885C2A7R1DA01#
			7.2pF	±0.05pF	GRM1885C2A7R2WA01#
				±0.1pF	GRM1885C2A7R2BA01#
				±0.25pF	GRM1885C2A7R2CA01#
				±0.5pF	GRM1885C2A7R2DA01#
			7.3pF	±0.05pF	GRM1885C2A7R3WA01#
				±0.1pF	GRM1885C2A7R3BA01#
				±0.25pF	GRM1885C2A7R3CA01#
				±0.5pF	GRM1885C2A7R3DA01#
			7.4pF	±0.05pF	GRM1885C2A7R4WA01#
				±0.1pF	GRM1885C2A7R4BA01#
				±0.25pF	GRM1885C2A7R4CA01#
				±0.5pF	GRM1885C2A7R4DA01#
7.5pF	±0.05pF	GRM1885C2A7R5WA01#			
	±0.1pF	GRM1885C2A7R5BA01#			

T寸法 最大値	定格 電圧	温度 特性	静電容量	許容差	品番
0.9mm	100Vdc	C0G	7.5pF	±0.25pF	GRM1885C2A7R5CA01#
				±0.5pF	GRM1885C2A7R5DA01#
			7.6pF	±0.05pF	GRM1885C2A7R6WA01#
				±0.1pF	GRM1885C2A7R6BA01#
				±0.25pF	GRM1885C2A7R6CA01#
			7.7pF	±0.05pF	GRM1885C2A7R7WA01#
				±0.1pF	GRM1885C2A7R7BA01#
				±0.25pF	GRM1885C2A7R7CA01#
			7.8pF	±0.05pF	GRM1885C2A7R8WA01#
				±0.1pF	GRM1885C2A7R8BA01#
				±0.25pF	GRM1885C2A7R8CA01#
			7.9pF	±0.05pF	GRM1885C2A7R9WA01#
				±0.1pF	GRM1885C2A7R9BA01#
				±0.25pF	GRM1885C2A7R9CA01#
			8.0pF	±0.05pF	GRM1885C2A8R0WA01#
				±0.1pF	GRM1885C2A8R0BA01#
				±0.25pF	GRM1885C2A8R0CA01#
			8.1pF	±0.05pF	GRM1885C2A8R1WA01#
				±0.1pF	GRM1885C2A8R1BA01#
				±0.25pF	GRM1885C2A8R1CA01#
			8.2pF	±0.05pF	GRM1885C2A8R2WA01#
				±0.1pF	GRM1885C2A8R2BA01#
				±0.25pF	GRM1885C2A8R2CA01#
			8.3pF	±0.05pF	GRM1885C2A8R3WA01#
				±0.1pF	GRM1885C2A8R3BA01#
				±0.25pF	GRM1885C2A8R3CA01#
			8.4pF	±0.05pF	GRM1885C2A8R4WA01#
				±0.1pF	GRM1885C2A8R4BA01#
				±0.25pF	GRM1885C2A8R4CA01#
			8.5pF	±0.05pF	GRM1885C2A8R5WA01#
				±0.1pF	GRM1885C2A8R5BA01#
				±0.25pF	GRM1885C2A8R5CA01#
			8.6pF	±0.05pF	GRM1885C2A8R6WA01#
				±0.1pF	GRM1885C2A8R6BA01#
				±0.25pF	GRM1885C2A8R6CA01#
			8.7pF	±0.05pF	GRM1885C2A8R7WA01#
				±0.1pF	GRM1885C2A8R7BA01#
				±0.25pF	GRM1885C2A8R7CA01#
			8.8pF	±0.05pF	GRM1885C2A8R8WA01#
				±0.1pF	GRM1885C2A8R8BA01#
				±0.25pF	GRM1885C2A8R8CA01#

品番 #には包装仕様コードが入ります。

GRMシリーズ
GJMシリーズ
GMAシリーズ
GMDシリーズ
GQMシリーズ
GRJシリーズ
GR3シリーズ
KRMシリーズ
KR3シリーズ
LLAシリーズ
LLLシリーズ
LLMシリーズ
LLRシリーズ
△注意/
使用上の注意

GRMシリーズ 温度補償用 品番表

(→ ■ 1.6×0.8mm)

T寸法 最大値	定格 電圧	温度 特性	静電容量	許容差	品番
0.9mm	100Vdc	C0G	8.9pF	±0.05pF	GRM1885C2A8R9WA01#
				±0.1pF	GRM1885C2A8R9BA01#
				±0.25pF	GRM1885C2A8R9CA01#
				±0.5pF	GRM1885C2A8R9DA01#
			9.0pF	±0.05pF	GRM1885C2A9R0WA01#
				±0.1pF	GRM1885C2A9R0BA01#
				±0.25pF	GRM1885C2A9R0CA01#
				±0.5pF	GRM1885C2A9R0DA01#
			9.1pF	±0.05pF	GRM1885C2A9R1WA01#
				±0.1pF	GRM1885C2A9R1BA01#
				±0.25pF	GRM1885C2A9R1CA01#
				±0.5pF	GRM1885C2A9R1DA01#
			9.2pF	±0.05pF	GRM1885C2A9R2WA01#
				±0.1pF	GRM1885C2A9R2BA01#
				±0.25pF	GRM1885C2A9R2CA01#
				±0.5pF	GRM1885C2A9R2DA01#
			9.3pF	±0.05pF	GRM1885C2A9R3WA01#
				±0.1pF	GRM1885C2A9R3BA01#
				±0.25pF	GRM1885C2A9R3CA01#
				±0.5pF	GRM1885C2A9R3DA01#
			9.4pF	±0.05pF	GRM1885C2A9R4WA01#
				±0.1pF	GRM1885C2A9R4BA01#
				±0.25pF	GRM1885C2A9R4CA01#
				±0.5pF	GRM1885C2A9R4DA01#
			9.5pF	±0.05pF	GRM1885C2A9R5WA01#
				±0.1pF	GRM1885C2A9R5BA01#
				±0.25pF	GRM1885C2A9R5CA01#
				±0.5pF	GRM1885C2A9R5DA01#
			9.6pF	±0.05pF	GRM1885C2A9R6WA01#
				±0.1pF	GRM1885C2A9R6BA01#
				±0.25pF	GRM1885C2A9R6CA01#
				±0.5pF	GRM1885C2A9R6DA01#
			9.7pF	±0.05pF	GRM1885C2A9R7WA01#
				±0.1pF	GRM1885C2A9R7BA01#
				±0.25pF	GRM1885C2A9R7CA01#
				±0.5pF	GRM1885C2A9R7DA01#
			9.8pF	±0.05pF	GRM1885C2A9R8WA01#
				±0.1pF	GRM1885C2A9R8BA01#
				±0.25pF	GRM1885C2A9R8CA01#
				±0.5pF	GRM1885C2A9R8DA01#
			9.9pF	±0.05pF	GRM1885C2A9R9WA01#
				±0.1pF	GRM1885C2A9R9BA01#
				±0.25pF	GRM1885C2A9R9CA01#
				±0.5pF	GRM1885C2A9R9DA01#
			10pF	±5%	GRM1885C2A100JA01#
			12pF	±5%	GRM1885C2A120JA01#
			15pF	±5%	GRM1885C2A150JA01#
			18pF	±5%	GRM1885C2A180JA01#
			22pF	±5%	GRM1885C2A220JA01#
			27pF	±5%	GRM1885C2A270JA01#
			33pF	±5%	GRM1885C2A330JA01#
			39pF	±5%	GRM1885C2A390JA01#
47pF	±5%	GRM1885C2A470JA01#			
56pF	±5%	GRM1885C2A560JA01#			

T寸法 最大値	定格 電圧	温度 特性	静電容量	許容差	品番		
0.9mm	100Vdc	C0G	68pF	±5%	GRM1885C2A680JA01#		
			82pF	±5%	GRM1885C2A820JA01#		
			100pF	±5%	GRM1885C2A101JA01#		
			120pF	±5%	GRM1885C2A121JA01#		
			150pF	±5%	GRM1885C2A151JA01#		
			180pF	±5%	GRM1885C2A181JA01#		
			220pF	±5%	GRM1885C2A221JA01#		
			270pF	±5%	GRM1885C2A271JA01#		
			330pF	±5%	GRM1885C2A331JA01#		
			390pF	±5%	GRM1885C2A391JA01#		
			470pF	±5%	GRM1885C2A471JA01#		
			560pF	±5%	GRM1885C2A561JA01#		
			680pF	±5%	GRM1885C2A681JA01#		
			820pF	±5%	GRM1885C2A821JA01#		
			1000pF	±5%	GRM1885C2A102JA01#		
			1200pF	±5%	GRM1885C2A122JA01#		
			1500pF	±5%	GRM1885C2A152JA01#		
			50Vdc	CK	0.50pF	±0.05pF	GRM1884C1HR50WA01#
						±0.1pF	GRM1884C1HR50BA01#
					0.60pF	±0.05pF	GRM1884C1HR60WA01#
						±0.1pF	GRM1884C1HR60BA01#
					0.70pF	±0.05pF	GRM1884C1HR70WA01#
						±0.1pF	GRM1884C1HR70BA01#
					0.80pF	±0.05pF	GRM1884C1HR80WA01#
						±0.1pF	GRM1884C1HR80BA01#
					0.90pF	±0.05pF	GRM1884C1HR90WA01#
						±0.1pF	GRM1884C1HR90BA01#
					1.0pF	±0.05pF	GRM1884C1H1R0WA01#
						±0.1pF	GRM1884C1H1R0BA01#
						±0.25pF	GRM1884C1H1R0CA01#
					1.1pF	±0.05pF	GRM1884C1H1R1WA01#
						±0.1pF	GRM1884C1H1R1BA01#
±0.25pF	GRM1884C1H1R1CA01#						
1.2pF	±0.05pF	GRM1884C1H1R2WA01#					
	±0.1pF	GRM1884C1H1R2BA01#					
	±0.25pF	GRM1884C1H1R2CA01#					
1.3pF	±0.05pF	GRM1884C1H1R3WA01#					
	±0.1pF	GRM1884C1H1R3BA01#					
	±0.25pF	GRM1884C1H1R3CA01#					
1.4pF	±0.05pF	GRM1884C1H1R4WA01#					
	±0.1pF	GRM1884C1H1R4BA01#					
	±0.25pF	GRM1884C1H1R4CA01#					
1.5pF	±0.05pF	GRM1884C1H1R5WA01#					
	±0.1pF	GRM1884C1H1R5BA01#					
	±0.25pF	GRM1884C1H1R5CA01#					
1.6pF	±0.05pF	GRM1884C1H1R6WA01#					
	±0.1pF	GRM1884C1H1R6BA01#					
	±0.25pF	GRM1884C1H1R6CA01#					
1.7pF	±0.05pF	GRM1884C1H1R7WA01#					
	±0.1pF	GRM1884C1H1R7BA01#					
	±0.25pF	GRM1884C1H1R7CA01#					
1.8pF	±0.05pF	GRM1884C1H1R8WA01#					
	±0.1pF	GRM1884C1H1R8BA01#					
	±0.25pF	GRM1884C1H1R8CA01#					

品番 #には包装仕様コードが入ります。

GRMシリーズ
 GJMシリーズ
 GMAシリーズ
 GMDシリーズ
 GQMシリーズ
 GRJシリーズ
 GR3シリーズ
 KRMシリーズ
 KR3シリーズ
 LLAシリーズ
 LLLシリーズ
 LLMシリーズ
 LLRシリーズ
 △注意/
 使用上の注意

GRMシリーズ 温度補償用 品番表

(→ ■ 1.6×0.8mm)

T寸法 最大値	定格 電圧	温度 特性	静電容量	許容差	品番	
0.9mm	50Vdc	CK	1.9pF	±0.05pF	GRM1884C1H1R9WA01#	
				±0.1pF	GRM1884C1H1R9BA01#	
				±0.25pF	GRM1884C1H1R9CA01#	
			2.0pF	±0.05pF	GRM1884C1H2R0WA01#	
				±0.1pF	GRM1884C1H2R0BA01#	
				±0.25pF	GRM1884C1H2R0CA01#	
			CJ	2.1pF	±0.05pF	GRM1883C1H2R1WA01#
					±0.1pF	GRM1883C1H2R1BA01#
					±0.25pF	GRM1883C1H2R1CA01#
				2.2pF	±0.05pF	GRM1883C1H2R2WA01#
					±0.1pF	GRM1883C1H2R2BA01#
					±0.25pF	GRM1883C1H2R2CA01#
				2.3pF	±0.05pF	GRM1883C1H2R3WA01#
					±0.1pF	GRM1883C1H2R3BA01#
					±0.25pF	GRM1883C1H2R3CA01#
				2.4pF	±0.05pF	GRM1883C1H2R4WA01#
					±0.1pF	GRM1883C1H2R4BA01#
					±0.25pF	GRM1883C1H2R4CA01#
		2.5pF		±0.05pF	GRM1883C1H2R5WA01#	
				±0.1pF	GRM1883C1H2R5BA01#	
				±0.25pF	GRM1883C1H2R5CA01#	
		2.6pF		±0.05pF	GRM1883C1H2R6WA01#	
				±0.1pF	GRM1883C1H2R6BA01#	
				±0.25pF	GRM1883C1H2R6CA01#	
		2.7pF	±0.05pF	GRM1883C1H2R7WA01#		
			±0.1pF	GRM1883C1H2R7BA01#		
			±0.25pF	GRM1883C1H2R7CA01#		
		2.8pF	±0.05pF	GRM1883C1H2R8WA01#		
			±0.1pF	GRM1883C1H2R8BA01#		
			±0.25pF	GRM1883C1H2R8CA01#		
		2.9pF	±0.05pF	GRM1883C1H2R9WA01#		
			±0.1pF	GRM1883C1H2R9BA01#		
			±0.25pF	GRM1883C1H2R9CA01#		
		3.0pF	±0.05pF	GRM1883C1H3R0WA01#		
			±0.1pF	GRM1883C1H3R0BA01#		
			±0.25pF	GRM1883C1H3R0CA01#		
		3.1pF	±0.05pF	GRM1883C1H3R1WA01#		
			±0.1pF	GRM1883C1H3R1BA01#		
			±0.25pF	GRM1883C1H3R1CA01#		
		3.2pF	±0.05pF	GRM1883C1H3R2WA01#		
			±0.1pF	GRM1883C1H3R2BA01#		
			±0.25pF	GRM1883C1H3R2CA01#		
		3.3pF	±0.05pF	GRM1883C1H3R3WA01#		
			±0.1pF	GRM1883C1H3R3BA01#		
			±0.25pF	GRM1883C1H3R3CA01#		
		3.4pF	±0.05pF	GRM1883C1H3R4WA01#		
			±0.1pF	GRM1883C1H3R4BA01#		
			±0.25pF	GRM1883C1H3R4CA01#		
3.5pF	±0.05pF	GRM1883C1H3R5WA01#				
	±0.1pF	GRM1883C1H3R5BA01#				
	±0.25pF	GRM1883C1H3R5CA01#				
3.6pF	±0.05pF	GRM1883C1H3R6WA01#				
	±0.1pF	GRM1883C1H3R6BA01#				
	±0.25pF	GRM1883C1H3R6CA01#				

T寸法 最大値	定格 電圧	温度 特性	静電容量	許容差	品番	
0.9mm	50Vdc	CJ	3.7pF	±0.05pF	GRM1883C1H3R7WA01#	
				±0.1pF	GRM1883C1H3R7BA01#	
				±0.25pF	GRM1883C1H3R7CA01#	
			3.8pF	±0.05pF	GRM1883C1H3R8WA01#	
				±0.1pF	GRM1883C1H3R8BA01#	
				±0.25pF	GRM1883C1H3R8CA01#	
			3.9pF	±0.05pF	GRM1883C1H3R9WA01#	
				±0.1pF	GRM1883C1H3R9BA01#	
				±0.25pF	GRM1883C1H3R9CA01#	
			CH	4.0pF	±0.05pF	GRM1882C1H4R0WA01#
					±0.1pF	GRM1882C1H4R0BA01#
					±0.25pF	GRM1882C1H4R0CA01#
				4.1pF	±0.05pF	GRM1882C1H4R1WA01#
					±0.1pF	GRM1882C1H4R1BA01#
					±0.25pF	GRM1882C1H4R1CA01#
				4.2pF	±0.05pF	GRM1882C1H4R2WA01#
					±0.1pF	GRM1882C1H4R2BA01#
					±0.25pF	GRM1882C1H4R2CA01#
		4.3pF		±0.05pF	GRM1882C1H4R3WA01#	
				±0.1pF	GRM1882C1H4R3BA01#	
				±0.25pF	GRM1882C1H4R3CA01#	
		4.4pF		±0.05pF	GRM1882C1H4R4WA01#	
				±0.1pF	GRM1882C1H4R4BA01#	
				±0.25pF	GRM1882C1H4R4CA01#	
		4.5pF		±0.05pF	GRM1882C1H4R5WA01#	
				±0.1pF	GRM1882C1H4R5BA01#	
				±0.25pF	GRM1882C1H4R5CA01#	
		4.6pF	±0.05pF	GRM1882C1H4R6WA01#		
			±0.1pF	GRM1882C1H4R6BA01#		
			±0.25pF	GRM1882C1H4R6CA01#		
		4.7pF	±0.05pF	GRM1882C1H4R7WA01#		
			±0.1pF	GRM1882C1H4R7BA01#		
			±0.25pF	GRM1882C1H4R7CA01#		
		4.8pF	±0.05pF	GRM1882C1H4R8WA01#		
			±0.1pF	GRM1882C1H4R8BA01#		
			±0.25pF	GRM1882C1H4R8CA01#		
		4.9pF	±0.05pF	GRM1882C1H4R9WA01#		
			±0.1pF	GRM1882C1H4R9BA01#		
			±0.25pF	GRM1882C1H4R9CA01#		
		5.0pF	±0.05pF	GRM1882C1H5R0WA01#		
			±0.1pF	GRM1882C1H5R0BA01#		
			±0.25pF	GRM1882C1H5R0CA01#		
		5.1pF	±0.05pF	GRM1882C1H5R1WA01#		
			±0.1pF	GRM1882C1H5R1BA01#		
			±0.25pF	GRM1882C1H5R1CA01#		
		5.2pF	±0.05pF	GRM1882C1H5R2WA01#		
			±0.1pF	GRM1882C1H5R2BA01#		
			±0.25pF	GRM1882C1H5R2CA01#		
5.3pF	±0.05pF	GRM1882C1H5R3WA01#				
	±0.1pF	GRM1882C1H5R3BA01#				
	±0.25pF	GRM1882C1H5R3CA01#				
			±0.5pF	GRM1882C1H5R3DA01#		

品番 #には包装仕様コードが入ります。

GRMシリーズ
GJMシリーズ
GMAシリーズ
GMDシリーズ
GQMシリーズ
GRJシリーズ
GR3シリーズ
KRMシリーズ
KR3シリーズ
LLAシリーズ
LLLシリーズ
LLMシリーズ
LLRシリーズ
△注意/
使用上の注意

GRMシリーズ 温度補償用 品番表

(→ ■ 1.6×0.8mm)

T寸法 最大値	定格 電圧	温度 特性	静電容量	許容差	品番
0.9mm	50Vdc	CH	5.4pF	±0.05pF	GRM1882C1H5R4WA01#
				±0.1pF	GRM1882C1H5R4BA01#
				±0.25pF	GRM1882C1H5R4CA01#
				±0.5pF	GRM1882C1H5R4DA01#
			5.5pF	±0.05pF	GRM1882C1H5R5WA01#
				±0.1pF	GRM1882C1H5R5BA01#
				±0.25pF	GRM1882C1H5R5CA01#
				±0.5pF	GRM1882C1H5R5DA01#
			5.6pF	±0.05pF	GRM1882C1H5R6WA01#
				±0.1pF	GRM1882C1H5R6BA01#
				±0.25pF	GRM1882C1H5R6CA01#
				±0.5pF	GRM1882C1H5R6DA01#
			5.7pF	±0.05pF	GRM1882C1H5R7WA01#
				±0.1pF	GRM1882C1H5R7BA01#
				±0.25pF	GRM1882C1H5R7CA01#
				±0.5pF	GRM1882C1H5R7DA01#
			5.8pF	±0.05pF	GRM1882C1H5R8WA01#
				±0.1pF	GRM1882C1H5R8BA01#
				±0.25pF	GRM1882C1H5R8CA01#
				±0.5pF	GRM1882C1H5R8DA01#
			5.9pF	±0.05pF	GRM1882C1H5R9WA01#
				±0.1pF	GRM1882C1H5R9BA01#
				±0.25pF	GRM1882C1H5R9CA01#
				±0.5pF	GRM1882C1H5R9DA01#
			6.0pF	±0.05pF	GRM1882C1H6R0WA01#
				±0.1pF	GRM1882C1H6R0BA01#
				±0.25pF	GRM1882C1H6R0CA01#
				±0.5pF	GRM1882C1H6R0DA01#
			6.1pF	±0.05pF	GRM1882C1H6R1WA01#
				±0.1pF	GRM1882C1H6R1BA01#
				±0.25pF	GRM1882C1H6R1CA01#
				±0.5pF	GRM1882C1H6R1DA01#
			6.2pF	±0.05pF	GRM1882C1H6R2WA01#
				±0.1pF	GRM1882C1H6R2BA01#
				±0.25pF	GRM1882C1H6R2CA01#
				±0.5pF	GRM1882C1H6R2DA01#
			6.3pF	±0.05pF	GRM1882C1H6R3WA01#
				±0.1pF	GRM1882C1H6R3BA01#
				±0.25pF	GRM1882C1H6R3CA01#
				±0.5pF	GRM1882C1H6R3DA01#
			6.4pF	±0.05pF	GRM1882C1H6R4WA01#
				±0.1pF	GRM1882C1H6R4BA01#
				±0.25pF	GRM1882C1H6R4CA01#
				±0.5pF	GRM1882C1H6R4DA01#
			6.5pF	±0.05pF	GRM1882C1H6R5WA01#
				±0.1pF	GRM1882C1H6R5BA01#
				±0.25pF	GRM1882C1H6R5CA01#
				±0.5pF	GRM1882C1H6R5DA01#
6.6pF	±0.05pF	GRM1882C1H6R6WA01#			
	±0.1pF	GRM1882C1H6R6BA01#			
	±0.25pF	GRM1882C1H6R6CA01#			
	±0.5pF	GRM1882C1H6R6DA01#			
6.7pF	±0.05pF	GRM1882C1H6R7WA01#			
	±0.1pF	GRM1882C1H6R7BA01#			

T寸法 最大値	定格 電圧	温度 特性	静電容量	許容差	品番
0.9mm	50Vdc	CH	6.7pF	±0.25pF	GRM1882C1H6R7CA01#
				±0.5pF	GRM1882C1H6R7DA01#
			6.8pF	±0.05pF	GRM1882C1H6R8WA01#
				±0.1pF	GRM1882C1H6R8BA01#
				±0.25pF	GRM1882C1H6R8CA01#
			6.9pF	±0.05pF	GRM1882C1H6R9WA01#
				±0.1pF	GRM1882C1H6R9BA01#
				±0.25pF	GRM1882C1H6R9CA01#
			7.0pF	±0.05pF	GRM1882C1H7R0WA01#
				±0.1pF	GRM1882C1H7R0BA01#
				±0.25pF	GRM1882C1H7R0CA01#
			7.1pF	±0.05pF	GRM1882C1H7R1WA01#
				±0.1pF	GRM1882C1H7R1BA01#
				±0.25pF	GRM1882C1H7R1CA01#
			7.2pF	±0.05pF	GRM1882C1H7R2WA01#
				±0.1pF	GRM1882C1H7R2BA01#
				±0.25pF	GRM1882C1H7R2CA01#
			7.3pF	±0.05pF	GRM1882C1H7R3WA01#
				±0.1pF	GRM1882C1H7R3BA01#
				±0.25pF	GRM1882C1H7R3CA01#
			7.4pF	±0.05pF	GRM1882C1H7R4WA01#
				±0.1pF	GRM1882C1H7R4BA01#
				±0.25pF	GRM1882C1H7R4CA01#
			7.5pF	±0.05pF	GRM1882C1H7R5WA01#
				±0.1pF	GRM1882C1H7R5BA01#
				±0.25pF	GRM1882C1H7R5CA01#
			7.6pF	±0.05pF	GRM1882C1H7R6WA01#
				±0.1pF	GRM1882C1H7R6BA01#
				±0.25pF	GRM1882C1H7R6CA01#
			7.7pF	±0.05pF	GRM1882C1H7R7WA01#
				±0.1pF	GRM1882C1H7R7BA01#
				±0.25pF	GRM1882C1H7R7CA01#
			7.8pF	±0.05pF	GRM1882C1H7R8WA01#
				±0.1pF	GRM1882C1H7R8BA01#
				±0.25pF	GRM1882C1H7R8CA01#
			7.9pF	±0.05pF	GRM1882C1H7R9WA01#
				±0.1pF	GRM1882C1H7R9BA01#
				±0.25pF	GRM1882C1H7R9CA01#
			8.0pF	±0.05pF	GRM1882C1H8R0WA01#
				±0.1pF	GRM1882C1H8R0BA01#
				±0.25pF	GRM1882C1H8R0CA01#

品番 #には包装仕様コードが入ります。

GRMシリーズ
 GJMシリーズ
 GMAシリーズ
 GMDシリーズ
 GQMシリーズ
 GRJシリーズ
 GR3シリーズ
 KRMシリーズ
 KR3シリーズ
 LLAシリーズ
 LLLシリーズ
 LLMシリーズ
 LLRシリーズ
 △注意/
 使用上の注意

GRMシリーズ 温度補償用 品番表

(→ ■ 1.6×0.8mm)

T寸法 最大値	定格 電圧	温度 特性	静電容量	許容差	品番
0.9mm	50Vdc	CH	8.1pF	±0.05pF	GRM1882C1H8R1WA01#
				±0.1pF	GRM1882C1H8R1BA01#
				±0.25pF	GRM1882C1H8R1CA01#
				±0.5pF	GRM1882C1H8R1DA01#
			8.2pF	±0.05pF	GRM1882C1H8R2WA01#
				±0.1pF	GRM1882C1H8R2BA01#
				±0.25pF	GRM1882C1H8R2CA01#
				±0.5pF	GRM1882C1H8R2DA01#
			8.3pF	±0.05pF	GRM1882C1H8R3WA01#
				±0.1pF	GRM1882C1H8R3BA01#
				±0.25pF	GRM1882C1H8R3CA01#
				±0.5pF	GRM1882C1H8R3DA01#
			8.4pF	±0.05pF	GRM1882C1H8R4WA01#
				±0.1pF	GRM1882C1H8R4BA01#
				±0.25pF	GRM1882C1H8R4CA01#
				±0.5pF	GRM1882C1H8R4DA01#
			8.5pF	±0.05pF	GRM1882C1H8R5WA01#
				±0.1pF	GRM1882C1H8R5BA01#
				±0.25pF	GRM1882C1H8R5CA01#
				±0.5pF	GRM1882C1H8R5DA01#
			8.6pF	±0.05pF	GRM1882C1H8R6WA01#
				±0.1pF	GRM1882C1H8R6BA01#
				±0.25pF	GRM1882C1H8R6CA01#
				±0.5pF	GRM1882C1H8R6DA01#
			8.7pF	±0.05pF	GRM1882C1H8R7WA01#
				±0.1pF	GRM1882C1H8R7BA01#
				±0.25pF	GRM1882C1H8R7CA01#
				±0.5pF	GRM1882C1H8R7DA01#
			8.8pF	±0.05pF	GRM1882C1H8R8WA01#
				±0.1pF	GRM1882C1H8R8BA01#
				±0.25pF	GRM1882C1H8R8CA01#
				±0.5pF	GRM1882C1H8R8DA01#
			8.9pF	±0.05pF	GRM1882C1H8R9WA01#
				±0.1pF	GRM1882C1H8R9BA01#
				±0.25pF	GRM1882C1H8R9CA01#
				±0.5pF	GRM1882C1H8R9DA01#
			9.0pF	±0.05pF	GRM1882C1H9R0WA01#
				±0.1pF	GRM1882C1H9R0BA01#
				±0.25pF	GRM1882C1H9R0CA01#
				±0.5pF	GRM1882C1H9R0DA01#
			9.1pF	±0.05pF	GRM1882C1H9R1WA01#
				±0.1pF	GRM1882C1H9R1BA01#
				±0.25pF	GRM1882C1H9R1CA01#
				±0.5pF	GRM1882C1H9R1DA01#
			9.2pF	±0.05pF	GRM1882C1H9R2WA01#
				±0.1pF	GRM1882C1H9R2BA01#
				±0.25pF	GRM1882C1H9R2CA01#
				±0.5pF	GRM1882C1H9R2DA01#
9.3pF	±0.05pF	GRM1882C1H9R3WA01#			
	±0.1pF	GRM1882C1H9R3BA01#			
	±0.25pF	GRM1882C1H9R3CA01#			
	±0.5pF	GRM1882C1H9R3DA01#			
9.4pF	±0.05pF	GRM1882C1H9R4WA01#			
	±0.1pF	GRM1882C1H9R4BA01#			

T寸法 最大値	定格 電圧	温度 特性	静電容量	許容差	品番
0.9mm	50Vdc	CH	9.4pF	±0.25pF	GRM1882C1H9R4CA01#
				±0.5pF	GRM1882C1H9R4DA01#
			9.5pF	±0.05pF	GRM1882C1H9R5WA01#
				±0.1pF	GRM1882C1H9R5BA01#
				±0.25pF	GRM1882C1H9R5CA01#
			9.6pF	±0.05pF	GRM1882C1H9R6WA01#
				±0.1pF	GRM1882C1H9R6BA01#
				±0.25pF	GRM1882C1H9R6CA01#
			9.7pF	±0.05pF	GRM1882C1H9R7WA01#
				±0.1pF	GRM1882C1H9R7BA01#
				±0.25pF	GRM1882C1H9R7CA01#
			9.8pF	±0.05pF	GRM1882C1H9R8WA01#
				±0.1pF	GRM1882C1H9R8BA01#
				±0.25pF	GRM1882C1H9R8CA01#
			9.9pF	±0.05pF	GRM1882C1H9R9WA01#
				±0.1pF	GRM1882C1H9R9BA01#
				±0.25pF	GRM1882C1H9R9CA01#
			10pF	±5%	GRM1882C1H100JA01#
				±5%	GRM1882C1H120JA01#
			12pF	±5%	GRM1882C1H120JA01#
				±5%	GRM1882C1H150JA01#
			15pF	±5%	GRM1882C1H180JA01#
				±5%	GRM1882C1H220JA01#
			22pF	±5%	GRM1882C1H220JA01#
				±5%	GRM1882C1H270JA01#
			27pF	±5%	GRM1882C1H270JA01#
				±5%	GRM1882C1H330JA01#
			33pF	±5%	GRM1882C1H330JA01#
				±5%	GRM1882C1H390JA01#
			39pF	±5%	GRM1882C1H390JA01#
				±5%	GRM1882C1H470JA01#
			47pF	±5%	GRM1882C1H470JA01#
				±5%	GRM1882C1H560JA01#
			56pF	±5%	GRM1882C1H560JA01#
				±5%	GRM1882C1H680JA01#
			68pF	±5%	GRM1882C1H680JA01#
				±5%	GRM1882C1H820JA01#
			82pF	±5%	GRM1882C1H820JA01#
				±5%	GRM1882C1H101JA01#
			100pF	±5%	GRM1882C1H101JA01#
				±5%	GRM1882C1H121JA01#
			120pF	±5%	GRM1882C1H121JA01#
				±5%	GRM1882C1H151JA01#
			150pF	±5%	GRM1882C1H151JA01#
				±5%	GRM1882C1H181JA01#
			180pF	±5%	GRM1882C1H181JA01#
				±5%	GRM1882C1H221JA01#
			220pF	±5%	GRM1882C1H221JA01#
±5%	GRM1882C1H271JA01#				
270pF	±5%	GRM1882C1H271JA01#			
	±5%	GRM1882C1H331JA01#			
330pF	±5%	GRM1882C1H331JA01#			
	±5%	GRM1882C1H391JA01#			
390pF	±5%	GRM1882C1H391JA01#			
	±5%	GRM1882C1H471JA01#			
470pF	±5%	GRM1882C1H471JA01#			
	±5%	GRM1882C1H561JA01#			
560pF	±5%	GRM1882C1H561JA01#			
	±5%	GRM1882C1H681JA01#			
680pF	±5%	GRM1882C1H681JA01#			
	±5%	GRM1882C1H821JA01#			
820pF	±5%	GRM1882C1H821JA01#			
	±5%	GRM1882C1H102JA01#			
1000pF	±5%	GRM1882C1H102JA01#			
	±5%	GRM1882C1H122JA01#			
1200pF	±5%	GRM1882C1H122JA01#			
	±5%	GRM1882C1H152JA01#			
1500pF	±5%	GRM1882C1H152JA01#			
	±5%	GRM1882C1H182JA01#			
1800pF	±5%	GRM1882C1H182JA01#			
	±5%	GRM1882C1H222JA01#			
2200pF	±5%	GRM1882C1H222JA01#			
	±5%	GRM1882C1H272JA01#			
2700pF	±5%	GRM1882C1H272JA01#			
	±5%	GRM1882C1H332JA01#			
3300pF	±5%	GRM1882C1H332JA01#			
	±5%	GRM1882C1H392JA01#			
3900pF	±5%	GRM1882C1H392JA01#			

品番 #には包装仕様コードが入ります。

GRMシリーズ
GJMシリーズ
GMAシリーズ
GMDシリーズ
GQMシリーズ
GRJシリーズ
GR3シリーズ
KRMシリーズ
KR3シリーズ
LLAシリーズ
LLLシリーズ
LLMシリーズ
LLRシリーズ
△注意/
使用上の注意

GRMシリーズ 温度補償用 品番表

(→ ■ 1.6×0.8mm)

T寸法 最大値	定格 電圧	温度 特性	静電容量	許容差	品番
0.9mm	50Vdc	CH	4700pF	±5%	GRM1882C1H472JA01#
			5600pF	±5%	GRM1882C1H562JA01#
			6800pF	±5%	GRM1882C1H682JA01#
			8200pF	±5%	GRM1882C1H822JA01#
			10000pF	±5%	GRM1882C1H103JA01#
		COG	0.50pF	±0.05pF	GRM1885C1HR50WA01#
				±0.1pF	GRM1885C1HR50BA01#
			0.60pF	±0.05pF	GRM1885C1HR60WA01#
				±0.1pF	GRM1885C1HR60BA01#
			0.70pF	±0.05pF	GRM1885C1HR70WA01#
				±0.1pF	GRM1885C1HR70BA01#
			0.80pF	±0.05pF	GRM1885C1HR80WA01#
				±0.1pF	GRM1885C1HR80BA01#
			0.90pF	±0.05pF	GRM1885C1HR90WA01#
				±0.1pF	GRM1885C1HR90BA01#
			1.0pF	±0.05pF	GRM1885C1H1R0WA01#
				±0.1pF	GRM1885C1H1R0BA01#
				±0.25pF	GRM1885C1H1R0CA01#
			1.1pF	±0.05pF	GRM1885C1H1R1WA01#
				±0.1pF	GRM1885C1H1R1BA01#
				±0.25pF	GRM1885C1H1R1CA01#
			1.2pF	±0.05pF	GRM1885C1H1R2WA01#
				±0.1pF	GRM1885C1H1R2BA01#
				±0.25pF	GRM1885C1H1R2CA01#
			1.3pF	±0.05pF	GRM1885C1H1R3WA01#
				±0.1pF	GRM1885C1H1R3BA01#
				±0.25pF	GRM1885C1H1R3CA01#
			1.4pF	±0.05pF	GRM1885C1H1R4WA01#
±0.1pF	GRM1885C1H1R4BA01#				
±0.25pF	GRM1885C1H1R4CA01#				
1.5pF	±0.05pF		GRM1885C1H1R5WA01#		
	±0.1pF		GRM1885C1H1R5BA01#		
	±0.25pF		GRM1885C1H1R5CA01#		
1.6pF	±0.05pF	GRM1885C1H1R6WA01#			
	±0.1pF	GRM1885C1H1R6BA01#			
	±0.25pF	GRM1885C1H1R6CA01#			
1.7pF	±0.05pF	GRM1885C1H1R7WA01#			
	±0.1pF	GRM1885C1H1R7BA01#			
	±0.25pF	GRM1885C1H1R7CA01#			
1.8pF	±0.05pF	GRM1885C1H1R8WA01#			
	±0.1pF	GRM1885C1H1R8BA01#			
	±0.25pF	GRM1885C1H1R8CA01#			
1.9pF	±0.05pF	GRM1885C1H1R9WA01#			
	±0.1pF	GRM1885C1H1R9BA01#			
	±0.25pF	GRM1885C1H1R9CA01#			
2.0pF	±0.05pF	GRM1885C1H2R0WA01#			
	±0.1pF	GRM1885C1H2R0BA01#			
	±0.25pF	GRM1885C1H2R0CA01#			
2.1pF	±0.05pF	GRM1885C1H2R1WA01#			
	±0.1pF	GRM1885C1H2R1BA01#			
	±0.25pF	GRM1885C1H2R1CA01#			
2.2pF	±0.05pF	GRM1885C1H2R2WA01#			
	±0.1pF	GRM1885C1H2R2BA01#			
	±0.25pF	GRM1885C1H2R2CA01#			

T寸法 最大値	定格 電圧	温度 特性	静電容量	許容差	品番
0.9mm	50Vdc	COG	2.3pF	±0.05pF	GRM1885C1H2R3WA01#
				±0.1pF	GRM1885C1H2R3BA01#
				±0.25pF	GRM1885C1H2R3CA01#
			2.4pF	±0.05pF	GRM1885C1H2R4WA01#
				±0.1pF	GRM1885C1H2R4BA01#
				±0.25pF	GRM1885C1H2R4CA01#
			2.5pF	±0.05pF	GRM1885C1H2R5WA01#
				±0.1pF	GRM1885C1H2R5BA01#
				±0.25pF	GRM1885C1H2R5CA01#
			2.6pF	±0.05pF	GRM1885C1H2R6WA01#
				±0.1pF	GRM1885C1H2R6BA01#
				±0.25pF	GRM1885C1H2R6CA01#
			2.7pF	±0.05pF	GRM1885C1H2R7WA01#
				±0.1pF	GRM1885C1H2R7BA01#
				±0.25pF	GRM1885C1H2R7CA01#
			2.8pF	±0.05pF	GRM1885C1H2R8WA01#
				±0.1pF	GRM1885C1H2R8BA01#
				±0.25pF	GRM1885C1H2R8CA01#
			2.9pF	±0.05pF	GRM1885C1H2R9WA01#
				±0.1pF	GRM1885C1H2R9BA01#
				±0.25pF	GRM1885C1H2R9CA01#
			3.0pF	±0.05pF	GRM1885C1H3R0WA01#
				±0.1pF	GRM1885C1H3R0BA01#
				±0.25pF	GRM1885C1H3R0CA01#
			3.1pF	±0.05pF	GRM1885C1H3R1WA01#
				±0.1pF	GRM1885C1H3R1BA01#
				±0.25pF	GRM1885C1H3R1CA01#
			3.2pF	±0.05pF	GRM1885C1H3R2WA01#
				±0.1pF	GRM1885C1H3R2BA01#
				±0.25pF	GRM1885C1H3R2CA01#
			3.3pF	±0.05pF	GRM1885C1H3R3WA01#
				±0.1pF	GRM1885C1H3R3BA01#
				±0.25pF	GRM1885C1H3R3CA01#
			3.4pF	±0.05pF	GRM1885C1H3R4WA01#
				±0.1pF	GRM1885C1H3R4BA01#
				±0.25pF	GRM1885C1H3R4CA01#
			3.5pF	±0.05pF	GRM1885C1H3R5WA01#
				±0.1pF	GRM1885C1H3R5BA01#
				±0.25pF	GRM1885C1H3R5CA01#
			3.6pF	±0.05pF	GRM1885C1H3R6WA01#
±0.1pF	GRM1885C1H3R6BA01#				
±0.25pF	GRM1885C1H3R6CA01#				
3.7pF	±0.05pF	GRM1885C1H3R7WA01#			
	±0.1pF	GRM1885C1H3R7BA01#			
	±0.25pF	GRM1885C1H3R7CA01#			
3.8pF	±0.05pF	GRM1885C1H3R8WA01#			
	±0.1pF	GRM1885C1H3R8BA01#			
	±0.25pF	GRM1885C1H3R8CA01#			
3.9pF	±0.05pF	GRM1885C1H3R9WA01#			
	±0.1pF	GRM1885C1H3R9BA01#			
	±0.25pF	GRM1885C1H3R9CA01#			
4.0pF	±0.05pF	GRM1885C1H4R0WA01#			
	±0.1pF	GRM1885C1H4R0BA01#			
	±0.25pF	GRM1885C1H4R0CA01#			

品番 #には包装仕様コードが入ります。

GRMシリーズ
 GJMシリーズ
 GMAシリーズ
 GMDシリーズ
 GQMシリーズ
 GRJシリーズ
 GR3シリーズ
 KRMシリーズ
 KR3シリーズ
 LLAシリーズ
 LLLシリーズ
 LLMシリーズ
 LLRシリーズ
 △注意/
 使用上の注意

GRMシリーズ 温度補償用 品番表

(→ ■ 1.6×0.8mm)

T寸法 最大値	定格 電圧	温度 特性	静電容量	許容差	品番
0.9mm	50Vdc	COG	4.1pF	±0.05pF	GRM1885C1H4R1WA01#
				±0.1pF	GRM1885C1H4R1BA01#
				±0.25pF	GRM1885C1H4R1CA01#
			4.2pF	±0.05pF	GRM1885C1H4R2WA01#
				±0.1pF	GRM1885C1H4R2BA01#
				±0.25pF	GRM1885C1H4R2CA01#
			4.3pF	±0.05pF	GRM1885C1H4R3WA01#
				±0.1pF	GRM1885C1H4R3BA01#
				±0.25pF	GRM1885C1H4R3CA01#
			4.4pF	±0.05pF	GRM1885C1H4R4WA01#
				±0.1pF	GRM1885C1H4R4BA01#
				±0.25pF	GRM1885C1H4R4CA01#
			4.5pF	±0.05pF	GRM1885C1H4R5WA01#
				±0.1pF	GRM1885C1H4R5BA01#
				±0.25pF	GRM1885C1H4R5CA01#
			4.6pF	±0.05pF	GRM1885C1H4R6WA01#
				±0.1pF	GRM1885C1H4R6BA01#
				±0.25pF	GRM1885C1H4R6CA01#
			4.7pF	±0.05pF	GRM1885C1H4R7WA01#
				±0.1pF	GRM1885C1H4R7BA01#
				±0.25pF	GRM1885C1H4R7CA01#
			4.8pF	±0.05pF	GRM1885C1H4R8WA01#
				±0.1pF	GRM1885C1H4R8BA01#
				±0.25pF	GRM1885C1H4R8CA01#
			4.9pF	±0.05pF	GRM1885C1H4R9WA01#
				±0.1pF	GRM1885C1H4R9BA01#
				±0.25pF	GRM1885C1H4R9CA01#
			5.0pF	±0.05pF	GRM1885C1H5R0WA01#
				±0.1pF	GRM1885C1H5R0BA01#
				±0.25pF	GRM1885C1H5R0CA01#
			5.1pF	±0.05pF	GRM1885C1H5R1WA01#
				±0.1pF	GRM1885C1H5R1BA01#
				±0.25pF	GRM1885C1H5R1CA01#
				±0.5pF	GRM1885C1H5R1DA01#
			5.2pF	±0.05pF	GRM1885C1H5R2WA01#
				±0.1pF	GRM1885C1H5R2BA01#
				±0.25pF	GRM1885C1H5R2CA01#
			5.3pF	±0.05pF	GRM1885C1H5R3WA01#
				±0.1pF	GRM1885C1H5R3BA01#
				±0.25pF	GRM1885C1H5R3CA01#
				±0.5pF	GRM1885C1H5R3DA01#
			5.4pF	±0.05pF	GRM1885C1H5R4WA01#
				±0.1pF	GRM1885C1H5R4BA01#
				±0.25pF	GRM1885C1H5R4CA01#
				±0.5pF	GRM1885C1H5R4DA01#
			5.5pF	±0.05pF	GRM1885C1H5R5WA01#
				±0.1pF	GRM1885C1H5R5BA01#
				±0.25pF	GRM1885C1H5R5CA01#
				±0.5pF	GRM1885C1H5R5DA01#
			5.6pF	±0.05pF	GRM1885C1H5R6WA01#
				±0.1pF	GRM1885C1H5R6BA01#
				±0.25pF	GRM1885C1H5R6CA01#
				±0.5pF	GRM1885C1H5R6DA01#

T寸法 最大値	定格 電圧	温度 特性	静電容量	許容差	品番
0.9mm	50Vdc	COG	5.7pF	±0.05pF	GRM1885C1H5R7WA01#
				±0.1pF	GRM1885C1H5R7BA01#
				±0.25pF	GRM1885C1H5R7CA01#
			5.8pF	±0.05pF	GRM1885C1H5R8WA01#
				±0.1pF	GRM1885C1H5R8BA01#
				±0.25pF	GRM1885C1H5R8CA01#
			5.9pF	±0.05pF	GRM1885C1H5R9WA01#
				±0.1pF	GRM1885C1H5R9BA01#
				±0.25pF	GRM1885C1H5R9CA01#
			6.0pF	±0.05pF	GRM1885C1H6R0WA01#
				±0.1pF	GRM1885C1H6R0BA01#
				±0.25pF	GRM1885C1H6R0CA01#
				±0.5pF	GRM1885C1H6R0DA01#
			6.1pF	±0.05pF	GRM1885C1H6R1WA01#
				±0.1pF	GRM1885C1H6R1BA01#
				±0.25pF	GRM1885C1H6R1CA01#
			6.2pF	±0.05pF	GRM1885C1H6R2WA01#
				±0.1pF	GRM1885C1H6R2BA01#
				±0.25pF	GRM1885C1H6R2CA01#
			6.3pF	±0.05pF	GRM1885C1H6R3WA01#
				±0.1pF	GRM1885C1H6R3BA01#
				±0.25pF	GRM1885C1H6R3CA01#
			6.4pF	±0.05pF	GRM1885C1H6R4WA01#
				±0.1pF	GRM1885C1H6R4BA01#
				±0.25pF	GRM1885C1H6R4CA01#
			6.5pF	±0.05pF	GRM1885C1H6R5WA01#
				±0.1pF	GRM1885C1H6R5BA01#
				±0.25pF	GRM1885C1H6R5CA01#
			6.6pF	±0.05pF	GRM1885C1H6R6WA01#
				±0.1pF	GRM1885C1H6R6BA01#
				±0.25pF	GRM1885C1H6R6CA01#
			6.7pF	±0.05pF	GRM1885C1H6R7WA01#
				±0.1pF	GRM1885C1H6R7BA01#
				±0.25pF	GRM1885C1H6R7CA01#
			6.8pF	±0.05pF	GRM1885C1H6R8WA01#
				±0.1pF	GRM1885C1H6R8BA01#
				±0.25pF	GRM1885C1H6R8CA01#
			6.9pF	±0.05pF	GRM1885C1H6R9WA01#
				±0.1pF	GRM1885C1H6R9BA01#
				±0.25pF	GRM1885C1H6R9CA01#
			7.0pF	±0.05pF	GRM1885C1H7R0WA01#
				±0.1pF	GRM1885C1H7R0BA01#

品番 #には包装仕様コードが入ります。

GRMシリーズ
GJMシリーズ
GMAシリーズ
GMDシリーズ
GQMシリーズ
GRJシリーズ
GR3シリーズ
KRMシリーズ
KR3シリーズ
LLAシリーズ
LLLシリーズ
LLMシリーズ
LLRシリーズ
△注意/
使用上の注意

GRMシリーズ 温度補償用 品番表

(→ ■ 1.6×0.8mm)

T寸法 最大値	定格 電圧	温度 特性	静電容量	許容差	品番			
0.9mm	50Vdc	COG	7.0pF	±0.25pF	GRM1885C1H7R0CA01#			
				±0.5pF	GRM1885C1H7R0DA01#			
			7.1pF	±0.05pF	GRM1885C1H7R1WA01#			
				±0.1pF	GRM1885C1H7R1BA01#			
				±0.25pF	GRM1885C1H7R1CA01#			
				±0.5pF	GRM1885C1H7R1DA01#			
			7.2pF	±0.05pF	GRM1885C1H7R2WA01#			
				±0.1pF	GRM1885C1H7R2BA01#			
				±0.25pF	GRM1885C1H7R2CA01#			
			7.3pF	±0.05pF	GRM1885C1H7R3WA01#			
				±0.1pF	GRM1885C1H7R3BA01#			
			7.4pF	±0.05pF	GRM1885C1H7R4WA01#			
				±0.1pF	GRM1885C1H7R4BA01#			
				±0.25pF	GRM1885C1H7R4CA01#			
			7.5pF	±0.05pF	GRM1885C1H7R5WA01#			
				±0.1pF	GRM1885C1H7R5BA01#			
				±0.25pF	GRM1885C1H7R5CA01#			
			7.6pF	±0.05pF	GRM1885C1H7R6WA01#			
				±0.1pF	GRM1885C1H7R6BA01#			
				±0.25pF	GRM1885C1H7R6CA01#			
			7.7pF	±0.05pF	GRM1885C1H7R7WA01#			
				±0.1pF	GRM1885C1H7R7BA01#			
				±0.25pF	GRM1885C1H7R7CA01#			
			7.8pF	±0.05pF	GRM1885C1H7R8WA01#			
				±0.1pF	GRM1885C1H7R8BA01#			
				±0.25pF	GRM1885C1H7R8CA01#			
			7.9pF	±0.05pF	GRM1885C1H7R9WA01#			
				±0.1pF	GRM1885C1H7R9BA01#			
				±0.25pF	GRM1885C1H7R9CA01#			
			8.0pF	±0.05pF	GRM1885C1H8R0WA01#			
				±0.1pF	GRM1885C1H8R0BA01#			
				±0.25pF	GRM1885C1H8R0CA01#			
			8.1pF	±0.05pF	GRM1885C1H8R1WA01#			
				±0.1pF	GRM1885C1H8R1BA01#			
				±0.25pF	GRM1885C1H8R1CA01#			
			8.2pF	±0.05pF	GRM1885C1H8R2WA01#			
				±0.1pF	GRM1885C1H8R2BA01#			
				±0.25pF	GRM1885C1H8R2CA01#			
			8.3pF	±0.05pF	GRM1885C1H8R3WA01#			
				±0.1pF	GRM1885C1H8R3BA01#			
				±0.25pF	GRM1885C1H8R3CA01#			
						8.4pF	±0.05pF	GRM1885C1H8R4WA01#
							±0.1pF	GRM1885C1H8R4BA01#
						8.5pF	±0.25pF	GRM1885C1H8R4CA01#
			±0.5pF	GRM1885C1H8R4DA01#				
			±0.05pF	GRM1885C1H8R5WA01#				
			±0.1pF	GRM1885C1H8R5BA01#				
			8.6pF	±0.25pF	GRM1885C1H8R5CA01#			
±0.5pF	GRM1885C1H8R5DA01#							
±0.05pF	GRM1885C1H8R6WA01#							
8.7pF	±0.1pF	GRM1885C1H8R6BA01#						
	±0.25pF	GRM1885C1H8R6CA01#						
	±0.5pF	GRM1885C1H8R6DA01#						
8.8pF	±0.05pF	GRM1885C1H8R7WA01#						
	±0.1pF	GRM1885C1H8R7BA01#						
	±0.25pF	GRM1885C1H8R7CA01#						
8.9pF	±0.5pF	GRM1885C1H8R7DA01#						
	±0.05pF	GRM1885C1H8R8WA01#						
	±0.1pF	GRM1885C1H8R8BA01#						
9.0pF	±0.25pF	GRM1885C1H8R8CA01#						
	±0.5pF	GRM1885C1H8R8DA01#						
	±0.05pF	GRM1885C1H8R9WA01#						
9.1pF	±0.1pF	GRM1885C1H8R9BA01#						
	±0.25pF	GRM1885C1H8R9CA01#						
	±0.5pF	GRM1885C1H8R9DA01#						
9.2pF	±0.05pF	GRM1885C1H9R0WA01#						
	±0.1pF	GRM1885C1H9R0BA01#						
	±0.25pF	GRM1885C1H9R0CA01#						
9.3pF	±0.5pF	GRM1885C1H9R0DA01#						
	±0.05pF	GRM1885C1H9R1WA01#						
	±0.1pF	GRM1885C1H9R1BA01#						
9.4pF	±0.25pF	GRM1885C1H9R1CA01#						
	±0.5pF	GRM1885C1H9R1DA01#						
	±0.05pF	GRM1885C1H9R2WA01#						
9.5pF	±0.1pF	GRM1885C1H9R2BA01#						
	±0.25pF	GRM1885C1H9R2CA01#						
	±0.5pF	GRM1885C1H9R2DA01#						
9.6pF	±0.05pF	GRM1885C1H9R3WA01#						
	±0.1pF	GRM1885C1H9R3BA01#						
	±0.25pF	GRM1885C1H9R3CA01#						
9.7pF	±0.5pF	GRM1885C1H9R3DA01#						
	±0.05pF	GRM1885C1H9R4WA01#						
	±0.1pF	GRM1885C1H9R4BA01#						
			9.8pF	±0.25pF	GRM1885C1H9R4CA01#			
				±0.5pF	GRM1885C1H9R4DA01#			
			9.9pF	±0.05pF	GRM1885C1H9R5WA01#			
±0.1pF	GRM1885C1H9R5BA01#							
±0.25pF	GRM1885C1H9R5CA01#							
±0.5pF	GRM1885C1H9R5DA01#							
10.0pF	±0.05pF	GRM1885C1H9R6WA01#						
	±0.1pF	GRM1885C1H9R6BA01#						
	±0.25pF	GRM1885C1H9R6CA01#						
10.1pF	±0.5pF	GRM1885C1H9R6DA01#						
	±0.05pF	GRM1885C1H9R7WA01#						
	±0.1pF	GRM1885C1H9R7BA01#						

T寸法 最大値	定格 電圧	温度 特性	静電容量	許容差	品番			
0.9mm	50Vdc	COG	8.4pF	±0.05pF	GRM1885C1H8R4WA01#			
				±0.1pF	GRM1885C1H8R4BA01#			
			8.5pF	±0.25pF	GRM1885C1H8R4CA01#			
				±0.5pF	GRM1885C1H8R4DA01#			
				±0.05pF	GRM1885C1H8R5WA01#			
				±0.1pF	GRM1885C1H8R5BA01#			
			8.6pF	±0.25pF	GRM1885C1H8R5CA01#			
				±0.5pF	GRM1885C1H8R5DA01#			
				±0.05pF	GRM1885C1H8R6WA01#			
			8.7pF	±0.1pF	GRM1885C1H8R6BA01#			
				±0.25pF	GRM1885C1H8R6CA01#			
				±0.5pF	GRM1885C1H8R6DA01#			
			8.8pF	±0.05pF	GRM1885C1H8R7WA01#			
				±0.1pF	GRM1885C1H8R7BA01#			
				±0.25pF	GRM1885C1H8R7CA01#			
			8.9pF	±0.5pF	GRM1885C1H8R7DA01#			
				±0.05pF	GRM1885C1H8R8WA01#			
				±0.1pF	GRM1885C1H8R8BA01#			
			9.0pF	±0.25pF	GRM1885C1H8R8CA01#			
				±0.5pF	GRM1885C1H8R8DA01#			
				±0.05pF	GRM1885C1H8R9WA01#			
			9.1pF	±0.1pF	GRM1885C1H8R9BA01#			
				±0.25pF	GRM1885C1H8R9CA01#			
				±0.5pF	GRM1885C1H8R9DA01#			
			9.2pF	±0.05pF	GRM1885C1H9R0WA01#			
				±0.1pF	GRM1885C1H9R0BA01#			
				±0.25pF	GRM1885C1H9R0CA01#			
			9.3pF	±0.5pF	GRM1885C1H9R0DA01#			
				±0.05pF	GRM1885C1H9R1WA01#			
				±0.1pF	GRM1885C1H9R1BA01#			
			9.4pF	±0.25pF	GRM1885C1H9R1CA01#			
				±0.5pF	GRM1885C1H9R1DA01#			
				±0.05pF	GRM1885C1H9R2WA01#			
			9.5pF	±0.1pF	GRM1885C1H9R2BA01#			
				±0.25pF	GRM1885C1H9R2CA01#			
				±0.5pF	GRM1885C1H9R2DA01#			
			9.6pF	±0.05pF	GRM1885C1H9R3WA01#			
				±0.1pF	GRM1885C1H9R3BA01#			
				±0.25pF	GRM1885C1H9R3CA01#			
			9.7pF	±0.5pF	GRM1885C1H9R3DA01#			
				±0.05pF	GRM1885C1H9R4WA01#			
				±0.1pF	GRM1885C1H9R4BA01#			
						9.8pF	±0.25pF	GRM1885C1H9R4CA01#
							±0.5pF	GRM1885C1H9R4DA01#
						9.9pF	±0.05pF	GRM1885C1H9R5WA01#
			±0.1pF	GRM1885C1H9R5BA01#				
			±0.25pF	GRM1885C1H9R5CA01#				
			±0.5pF	GRM1885C1H9R5DA01#				
10.0pF	±0.05pF	GRM1885C1H9R6WA01#						
	±0.1pF	GRM1885C1H9R6BA01#						
	±0.25pF	GRM1885C1H9R6CA01#						
10.1pF	±0.5pF	GRM1885C1H9R6DA01#						
	±0.05pF	GRM1885C1H9R7WA01#						
	±0.1pF	GRM1885C1H9R7BA01#						

品番 #には包装仕様コードが入ります。

GRMシリーズ
 GJMシリーズ
 GMAシリーズ
 GMDシリーズ
 GQMシリーズ
 GRJシリーズ
 GR3シリーズ
 KRMシリーズ
 KR3シリーズ
 LLAシリーズ
 LLLシリーズ
 LLMシリーズ
 LLRシリーズ
 △注意/
 使用上の注意

GRMシリーズ 温度補償用 品番表

(→ ■ 1.6×0.8mm)

T寸法 最大値	定格 電圧	温度 特性	静電容量	許容差	品番
0.9mm	50Vdc	COG	9.7pF	±0.25pF	GRM1885C1H9R7CA01#
				±0.5pF	GRM1885C1H9R7DA01#
			9.8pF	±0.05pF	GRM1885C1H9R8WA01#
				±0.1pF	GRM1885C1H9R8BA01#
				±0.25pF	GRM1885C1H9R8CA01#
				±0.5pF	GRM1885C1H9R8DA01#
				±0.05pF	GRM1885C1H9R9WA01#
			9.9pF	±0.1pF	GRM1885C1H9R9BA01#
				±0.25pF	GRM1885C1H9R9CA01#
				±0.5pF	GRM1885C1H9R9DA01#
			10pF	±5%	GRM1885C1H100JA01#
			12pF	±5%	GRM1885C1H120JA01#
			15pF	±5%	GRM1885C1H150JA01#
			18pF	±5%	GRM1885C1H180JA01#
			22pF	±5%	GRM1885C1H220JA01#
			27pF	±5%	GRM1885C1H270JA01#
			33pF	±5%	GRM1885C1H330JA01#
			39pF	±5%	GRM1885C1H390JA01#
			47pF	±5%	GRM1885C1H470JA01#
			56pF	±5%	GRM1885C1H560JA01#
			68pF	±5%	GRM1885C1H680JA01#
			82pF	±5%	GRM1885C1H820JA01#
			100pF	±5%	GRM1885C1H101JA01#
			120pF	±5%	GRM1885C1H121JA01#
			150pF	±5%	GRM1885C1H151JA01#
			180pF	±5%	GRM1885C1H181JA01#
			220pF	±5%	GRM1885C1H221JA01#
			270pF	±5%	GRM1885C1H271JA01#
			330pF	±5%	GRM1885C1H331JA01#
			390pF	±5%	GRM1885C1H391JA01#
			470pF	±5%	GRM1885C1H471JA01#
			560pF	±5%	GRM1885C1H561JA01#
			680pF	±5%	GRM1885C1H681JA01#
			820pF	±5%	GRM1885C1H821JA01#
			1000pF	±5%	GRM1885C1H102JA01#
			1200pF	±5%	GRM1885C1H122JA01#
			1500pF	±5%	GRM1885C1H152JA01#
			1800pF	±5%	GRM1885C1H182JA01#
			2200pF	±5%	GRM1885C1H222JA01#
			2700pF	±5%	GRM1885C1H272JA01#
			3300pF	±5%	GRM1885C1H332JA01#
			3900pF	±5%	GRM1885C1H392JA01#
			4700pF	±5%	GRM1885C1H472JA01#
			5600pF	±5%	GRM1885C1H562JA01#
			6800pF	±5%	GRM1885C1H682JA01#
8200pF	±5%	GRM1885C1H822JA01#			
10000pF	±5%	GRM1885C1H103JA01#			
SL	1200pF	±5%	GRM1881X1H122JA01#		
	1500pF	±5%	GRM1881X1H152JA01#		
	1800pF	±5%	GRM1881X1H182JA01#		
	2200pF	±5%	GRM1881X1H222JA01#		
	2700pF	±5%	GRM1881X1H272JA01#		
	3300pF	±5%	GRM1881X1H332JA01#		
	3900pF	±5%	GRM1881X1H392JA01#		
	4700pF	±5%	GRM1881X1H472JA01#		
	5600pF	±5%	GRM1881X1H562JA01#		

T寸法 最大値	定格 電圧	温度 特性	静電容量	許容差	品番		
0.9mm	50Vdc	SL	4700pF	±5%	GRM1881X1H472JA01#		
			5600pF	±5%	GRM1881X1H562JA01#		
			6800pF	±5%	GRM1881X1H682JA01#		
			8200pF	±5%	GRM1881X1H822JA01#		
			10000pF	±5%	GRM1881X1H103JA01#		
			UU	1000pF	±5%	GRM1883U1H102JA01#	
				1200pF	±5%	GRM1883U1H122JA01#	
				1500pF	±5%	GRM1883U1H152JA01#	
				1800pF	±5%	GRM1883U1H182JA01#	
				2200pF	±5%	GRM1883U1H222JA01#	
		2700pF		±5%	GRM1883U1H272JA01#		
		3300pF		±5%	GRM1883U1H332JA01#		
		3900pF		±5%	GRM1883U1H392JA01#		
		4700pF		±5%	GRM1883U1H472JA01#		
		5600pF		±5%	GRM1883U1H562JA01#		
		U2J	1200pF	±5%	GRM1887U1H122JA01#		
			1500pF	±5%	GRM1887U1H152JA01#		
			1800pF	±5%	GRM1887U1H182JA01#		
			2200pF	±5%	GRM1887U1H222JA01#		
			2700pF	±5%	GRM1887U1H272JA01#		
			3300pF	±5%	GRM1887U1H332JA01#		
			3900pF	±5%	GRM1887U1H392JA01#		
			4700pF	±5%	GRM1887U1H472JA01#		
			5600pF	±5%	GRM1887U1H562JA01#		
			6800pF	±5%	GRM1887U1H682JA01#		
		10Vdc	SL	12000pF	±5%	GRM1881X1A123JA01#	
				15000pF	±5%	GRM1881X1A153JA01#	
				18000pF	±5%	GRM1881X1A183JA01#	
				22000pF	±5%	GRM1881X1A223JA01#	
			UU	12000pF	±5%	GRM1883U1A123JA01#	
				15000pF	±5%	GRM1883U1A153JA01#	
				18000pF	±5%	GRM1883U1A183JA01#	
				22000pF	±5%	GRM1883U1A223JA01#	
				U2J	12000pF	±5%	GRM1887U1A123JA01#
					15000pF	±5%	GRM1887U1A153JA01#
		22000pF	±5%	GRM1887U1A183JA01#			
			±5%	GRM1887U1A223JA01#			
			±5%	GRM1887U1A123JA01#			
			±5%	GRM1887U1A153JA01#			
			±5%	GRM1887U1A183JA01#			
			±5%	GRM1887U1A223JA01#			

■ 2.0×1.25mm

T寸法 最大値	定格 電圧	温度 特性	静電容量	許容差	品番
0.7mm	100Vdc	CH	100pF	±5%	GRM2162C2A101JA01#
			120pF	±5%	GRM2162C2A121JA01#
			150pF	±5%	GRM2162C2A151JA01#
			180pF	±5%	GRM2162C2A181JA01#
			220pF	±5%	GRM2162C2A221JA01#
			270pF	±5%	GRM2162C2A271JA01#
			330pF	±5%	GRM2162C2A331JA01#

品番 #には包装仕様コードが入ります。

GRMシリーズ
GJMシリーズ
GMAシリーズ
GMDシリーズ
GQMシリーズ
GRJシリーズ
GR3シリーズ
KRMシリーズ
KR3シリーズ
LLAシリーズ
LLLシリーズ
LLMシリーズ
LLRシリーズ
△注意/
使用上の注意

GRMシリーズ 温度補償用 品番表

(→ ■2.0×1.25mm)

T寸法 最大値	定格 電圧	温度 特性	静電容量	許容差	品番		
0.7mm	100Vdc	CH	390pF	±5%	GRM2162C2A391JA01#		
			470pF	±5%	GRM2162C2A471JA01#		
			560pF	±5%	GRM2162C2A561JA01#		
			680pF	±5%	GRM2162C2A681JA01#		
			820pF	±5%	GRM2162C2A821JA01#		
			1000pF	±5%	GRM2162C2A102JA01#		
			1200pF	±5%	GRM2162C2A122JA01#		
			1500pF	±5%	GRM2162C2A152JA01#		
			1800pF	±5%	GRM2162C2A182JA01#		
			2200pF	±5%	GRM2162C2A222JA01#		
			2700pF	±5%	GRM2162C2A272JA01#		
			3300pF	±5%	GRM2162C2A332JA01#		
			COG	100pF	±5%	GRM2165C2A101JA01#	
				120pF	±5%	GRM2165C2A121JA01#	
				150pF	±5%	GRM2165C2A151JA01#	
				180pF	±5%	GRM2165C2A181JA01#	
				220pF	±5%	GRM2165C2A221JA01#	
				270pF	±5%	GRM2165C2A271JA01#	
				330pF	±5%	GRM2165C2A331JA01#	
				390pF	±5%	GRM2165C2A391JA01#	
				470pF	±5%	GRM2165C2A471JA01#	
				560pF	±5%	GRM2165C2A561JA01#	
				680pF	±5%	GRM2165C2A681JA01#	
			820pF	±5%	GRM2165C2A821JA01#		
			1000pF	±5%	GRM2165C2A102JA01#		
			1200pF	±5%	GRM2165C2A122JA01#		
			1500pF	±5%	GRM2165C2A152JA01#		
			1800pF	±5%	GRM2165C2A182JA01#		
			2200pF	±5%	GRM2165C2A222JA01#		
			2700pF	±5%	GRM2165C2A272JA01#		
			3300pF	±5%	GRM2165C2A332JA01#		
			50Vdc	CH	1200pF	±5%	GRM2162C1H122JA01#
					1500pF	±5%	GRM2162C1H152JA01#
	1800pF	±5%			GRM2162C1H182JA01#		
	2200pF	±5%			GRM2162C1H222JA01#		
	2700pF	±5%			GRM2162C1H272JA01#		
	3300pF	±5%			GRM2162C1H332JA01#		
	3900pF	±5%			GRM2162C1H392JA01#		
	4700pF	±5%			GRM2162C1H472JA01#		
	COG	1200pF			±5%	GRM2165C1H122JA01#	
		1500pF			±5%	GRM2165C1H152JA01#	
		1800pF			±5%	GRM2165C1H182JA01#	
		2200pF	±5%	GRM2165C1H222JA01#			
		2700pF	±5%	GRM2165C1H272JA01#			
3300pF		±5%	GRM2165C1H332JA01#				
3900pF		±5%	GRM2165C1H392JA01#				
4700pF		±5%	GRM2165C1H472JA01#				
SL	12000pF	±5%	GRM2161X1H123JA01#				
	15000pF	±5%	GRM2161X1H153JA01#				
	18000pF	±5%	GRM2161X1H183JA01#				
UJ	10000pF	±5%	GRM2163U1H103JA01#				
	12000pF	±5%	GRM2163U1H123JA01#				
	15000pF	±5%	GRM2163U1H153JA01#				
	18000pF	±5%	GRM2163U1H183JA01#				

T寸法 最大値	定格 電圧	温度 特性	静電容量	許容差	品番		
0.7mm	50Vdc	U2J	12000pF	±5%	GRM2167U1H123JA01#		
			15000pF	±5%	GRM2167U1H153JA01#		
			18000pF	±5%	GRM2167U1H183JA01#		
		0.95mm	50Vdc	CH	5600pF	±5%	GRM2192C1H562JA01#
					6800pF	±5%	GRM2192C1H682JA01#
					8200pF	±5%	GRM2192C1H822JA01#
					10000pF	±5%	GRM2192C1H103JA01#
					12000pF	±5%	GRM2192C1H123JA01#
					15000pF	±5%	GRM2192C1H153JA01#
COG	5600pF			±5%	GRM2195C1H562JA01#		
	6800pF			±5%	GRM2195C1H682JA01#		
	8200pF			±5%	GRM2195C1H822JA01#		
	10000pF			±5%	GRM2195C1H103JA01#		
	12000pF			±5%	GRM2195C1H123JA01#		
	15000pF			±5%	GRM2195C1H153JA01#		
10Vdc	SL	22000pF	±5%	GRM2191X1H223JA01#			
		27000pF	±5%	GRM2191X1H273JA01#			
	UJ	22000pF	±5%	GRM2193U1H223JA01#			
		27000pF	±5%	GRM2193U1H273JA01#			
	U2J	22000pF	±5%	GRM2197U1H223JA01#			
		27000pF	±5%	GRM2197U1H273JA01#			
1.0mm	250Vdc	COG	10pF	±5%	GRM21A5C2E100JW01#		
			12pF	±5%	GRM21A5C2E120JW01#		
			15pF	±5%	GRM21A5C2E150JW01#		
			18pF	±5%	GRM21A5C2E180JW01#		
			22pF	±5%	GRM21A5C2E220JW01#		
			27pF	±5%	GRM21A5C2E270JW01#		
			33pF	±5%	GRM21A5C2E330JW01#		
			39pF	±5%	GRM21A5C2E390JW01#		
			47pF	±5%	GRM21A5C2E470JW01#		
			56pF	±5%	GRM21A5C2E560JW01#		
			68pF	±5%	GRM21A5C2E680JW01#		
			82pF	±5%	GRM21A5C2E820JW01#		
			100pF	±5%	GRM21A5C2E101JW01#		
			120pF	±5%	GRM21A5C2E121JW01#		
			150pF	±5%	GRM21A5C2E151JW01#		
		180pF	±5%	GRM21A5C2E181JW01#			
		220pF	±5%	GRM21A5C2E221JW01#			
		270pF	±5%	GRM21A5C2E271JW01#			
		330pF	±5%	GRM21A5C2E331JW01#			
		U2J	100pF	±5%	GRM21A7U2E101JW31#		
			120pF	±5%	GRM21A7U2E121JW31#		
			150pF	±5%	GRM21A7U2E151JW31#		
			180pF	±5%	GRM21A7U2E181JW31#		
			220pF	±5%	GRM21A7U2E221JW31#		
			270pF	±5%	GRM21A7U2E271JW31#		
			330pF	±5%	GRM21A7U2E331JW31#		
			390pF	±5%	GRM21A7U2E391JW31#		
470pF	±5%		GRM21A7U2E471JW31#				
560pF	±5%		GRM21A7U2E561JW31#				
680pF	±5%		GRM21A7U2E681JW31#				

品番 #には包装仕様コードが入ります。

GRMシリーズ
 GJMシリーズ
 GMAシリーズ
 GMDシリーズ
 GQMシリーズ
 GRJシリーズ
 GR3シリーズ
 KRMシリーズ
 KR3シリーズ
 LLAシリーズ
 LLLシリーズ
 LLMシリーズ
 LLRシリーズ
 △注意/
 使用上の注意

GRMシリーズ 温度補償用 品番表

(→ ■2.0×1.25mm)

T寸法 最大値	定格 電圧	温度 特性	静電容量	許容差	品番	
1.0mm	250Vdc	U2J	820pF	±5%	GRM21A7U2E821JW31#	
			1000pF	±5%	GRM21A7U2E102JW31#	
			1200pF	±5%	GRM21A7U2E122JW31#	
			1500pF	±5%	GRM21A7U2E152JW31#	
			1800pF	±5%	GRM21A7U2E182JW31#	
			2200pF	±5%	GRM21A7U2E222JW31#	
		200Vdc	C0G	10pF	±5%	GRM21A5C2D100JW01#
				12pF	±5%	GRM21A5C2D120JW01#
				15pF	±5%	GRM21A5C2D150JW01#
				18pF	±5%	GRM21A5C2D180JW01#
				22pF	±5%	GRM21A5C2D220JW01#
				27pF	±5%	GRM21A5C2D270JW01#
	33pF			±5%	GRM21A5C2D330JW01#	
	39pF			±5%	GRM21A5C2D390JW01#	
	47pF			±5%	GRM21A5C2D470JW01#	
	56pF			±5%	GRM21A5C2D560JW01#	
	68pF			±5%	GRM21A5C2D680JW01#	
	82pF			±5%	GRM21A5C2D820JW01#	
	100pF		±5%	GRM21A5C2D101JW01#		
	120pF		±5%	GRM21A5C2D121JW01#		
	150pF		±5%	GRM21A5C2D151JW01#		
	180pF		±5%	GRM21A5C2D181JW01#		
	220pF		±5%	GRM21A5C2D221JW01#		
	270pF		±5%	GRM21A5C2D271JW01#		
	330pF		±5%	GRM21A5C2D331JW01#		
	U2J		100pF	±5%	GRM21A7U2D101JW31#	
			120pF	±5%	GRM21A7U2D121JW31#	
			150pF	±5%	GRM21A7U2D151JW31#	
			180pF	±5%	GRM21A7U2D181JW31#	
			220pF	±5%	GRM21A7U2D221JW31#	
		270pF	±5%	GRM21A7U2D271JW31#		
		330pF	±5%	GRM21A7U2D331JW31#		
		390pF	±5%	GRM21A7U2D391JW31#		
		470pF	±5%	GRM21A7U2D471JW31#		
		560pF	±5%	GRM21A7U2D561JW31#		
		680pF	±5%	GRM21A7U2D681JW31#		
820pF		±5%	GRM21A7U2D821JW31#			
50Vdc	SL	33000pF	±5%	GRM21A1X1H333JA39#		
		UJ	33000pF	±5%	GRM21A3U1H333JA39#	
		U2J	33000pF	±5%	GRM21A7U1H333JA39#	
	1.35mm	50Vdc	CH	18000pF	±5%	GRM21B2C1H183JA01#
				22000pF	±5%	GRM21B2C1H223JA01#
			C0G	18000pF	±5%	GRM21B5C1H183JA01#
				22000pF	±5%	GRM21B5C1H223JA01#
			SL	39000pF	±5%	GRM21B1X1H393JA01#
				47000pF	±5%	GRM21B1X1H473JA01#
UJ		39000pF		±5%	GRM21B3U1H393JA01#	
U2J		47000pF	±5%	GRM21B3U1H473JA01#		
		39000pF	±5%	GRM21B7U1H393JA01#		
	39000pF	±5%	GRM21B7U1H393JA01#			

T寸法 最大値	定格 電圧	温度 特性	静電容量	許容差	品番	
1.35mm	50Vdc	U2J	47000pF	±5%	GRM21B7U1H473JA01#	
			SL	68000pF	±5%	GRM21B1X1A683JA01#
			82000pF	±5%	GRM21B1X1A823JA01#	
		UJ	0.10μF	±5%	GRM21B1X1A104JA01#	
			68000pF	±5%	GRM21B3U1A683JA01#	
			82000pF	±5%	GRM21B3U1A823JA01#	
	250Vdc	U2J	0.10μF	±5%	GRM21B3U1A104JA01#	
			68000pF	±5%	GRM21B7U1A683JA01#	
			82000pF	±5%	GRM21B7U1A823JA01#	
		U2J	0.10μF	±5%	GRM21B7U1A104JA01#	
			2700pF	±5%	GRM21B7U2E272JW32#	
			3300pF	±5%	GRM21B7U2E332JW32#	
1.45mm	250Vdc	U2J	3900pF	±5%	GRM21B7U2E392JW32#	
			4700pF	±5%	GRM21B7U2E472JW32#	
			5600pF	±5%	GRM21B7U2E562JW32#	
		U2J	2700pF	±5%	GRM21B7U2D272JW32#	
			3300pF	±5%	GRM21B7U2D332JW32#	
			3900pF	±5%	GRM21B7U2D392JW32#	
	200Vdc	U2J	4700pF	±5%	GRM21B7U2D472JW32#	
			5600pF	±5%	GRM21B7U2D562JW32#	
			2700pF	±5%	GRM21B7U2D272JW32#	
		U2J	3300pF	±5%	GRM21B7U2D332JW32#	
			3900pF	±5%	GRM21B7U2D392JW32#	
			4700pF	±5%	GRM21B7U2D472JW32#	
5600pF	±5%	GRM21B7U2D562JW32#				

■3.2×1.6mm

T寸法 最大値	定格 電圧	温度 特性	静電容量	許容差	品番
0.95mm	100Vdc	CH	1800pF	±5%	GRM3192C2A182JA01#
			2200pF	±5%	GRM3192C2A222JA01#
			2700pF	±5%	GRM3192C2A272JA01#
			3300pF	±5%	GRM3192C2A332JA01#
			3900pF	±5%	GRM3192C2A392JA01#
			4700pF	±5%	GRM3192C2A472JA01#
			5600pF	±5%	GRM3192C2A562JA01#
			6800pF	±5%	GRM3192C2A682JA01#
			8200pF	±5%	GRM3192C2A822JA01#
			10000pF	±5%	GRM3192C2A103JA01#
			12000pF	±5%	GRM3192C2A123JA01#
			15000pF	±5%	GRM3192C2A153JA01#
		18000pF	±5%	GRM3192C2A183JA01#	
		22000pF	±5%	GRM3192C2A223JA01#	
		C0G	1800pF	±5%	GRM3195C2A182JA01#
			2200pF	±5%	GRM3195C2A222JA01#
			2700pF	±5%	GRM3195C2A272JA01#
			3300pF	±5%	GRM3195C2A332JA01#
			3900pF	±5%	GRM3195C2A392JA01#
			4700pF	±5%	GRM3195C2A472JA01#
			5600pF	±5%	GRM3195C2A562JA01#
			6800pF	±5%	GRM3195C2A682JA01#
			8200pF	±5%	GRM3195C2A822JA01#
			10000pF	±5%	GRM3195C2A103JA01#
	12000pF		±5%	GRM3195C2A123JA01#	
	15000pF		±5%	GRM3195C2A153JA01#	
	50Vdc	CH	12000pF	±5%	GRM3192C1H123JA01#
			18000pF	±5%	GRM3192C1H183JA01#
			22000pF	±5%	GRM3192C1H223JA01#
			39000pF	±5%	GRM3192C1H393JA01#
			47000pF	±5%	GRM3192C1H473JA01#
			39000pF	±5%	GRM3192C1H393JA01#

品番 #には包装仕様コードが入ります。

GRMシリーズ
GJMシリーズ
GMAシリーズ
GMDシリーズ
GQMシリーズ
GRJシリーズ
GR3シリーズ
KRMシリーズ
KR3シリーズ
LLAシリーズ
LLLシリーズ
LLMシリーズ
LLRシリーズ
△注意/
使用上の注意

GRMシリーズ 温度補償用 品番表

(→ ■3.2×1.6mm)

T寸法 最大値	定格 電圧	温度 特性	静電容量	許容差	品番		
0.95mm	50Vdc	CH	15000pF	±5%	GRM3192C1H153JA01#		
			18000pF	±5%	GRM3192C1H183JA01#		
			22000pF	±5%	GRM3192C1H223JA01#		
			27000pF	±5%	GRM3192C1H273JA01#		
			33000pF	±5%	GRM3192C1H333JA01#		
			39000pF	±5%	GRM3192C1H393JA01#		
			COG	12000pF	±5%	GRM3195C1H123JA01#	
				15000pF	±5%	GRM3195C1H153JA01#	
				18000pF	±5%	GRM3195C1H183JA01#	
		22000pF		±5%	GRM3195C1H223JA01#		
		27000pF		±5%	GRM3195C1H273JA01#		
		33000pF		±5%	GRM3195C1H333JA01#		
		39000pF		±5%	GRM3195C1H393JA01#		
		SL		56000pF	±5%	GRM3191X1H563JA01#	
		UJ		56000pF	±5%	GRM3193U1H563JA01#	
		U2J	56000pF	±5%	GRM3197U1H563JA01#		
		1.0mm	2000Vdc	U2J	10pF	±5%	GRM31A7U3D100JW31#
					12pF	±5%	GRM31A7U3D120JW31#
					15pF	±5%	GRM31A7U3D150JW31#
					18pF	±5%	GRM31A7U3D180JW31#
					22pF	±5%	GRM31A7U3D220JW31#
27pF	±5%				GRM31A7U3D270JW31#		
33pF	±5%				GRM31A7U3D330JW31#		
39pF	±5%				GRM31A7U3D390JW31#		
47pF	±5%				GRM31A7U3D470JW31#		
56pF	±5%				GRM31A7U3D560JW31#		
68pF	±5%				GRM31A7U3D680JW31#		
COG	10pF				±5%	GRM31A5C3A100JW01#	
	12pF				±5%	GRM31A5C3A120JW01#	
	15pF				±5%	GRM31A5C3A150JW01#	
	18pF				±5%	GRM31A5C3A180JW01#	
	22pF			±5%	GRM31A5C3A220JW01#		
	27pF			±5%	GRM31A5C3A270JW01#		
	33pF			±5%	GRM31A5C3A330JW01#		
	39pF			±5%	GRM31A5C3A390JW01#		
	47pF			±5%	GRM31A5C3A470JW01#		
	56pF			±5%	GRM31A5C3A560JW01#		
	68pF		±5%	GRM31A5C3A680JW01#			
	82pF		±5%	GRM31A5C3A820JW01#			
	100pF		±5%	GRM31A5C3A101JW01#			
	120pF		±5%	GRM31A5C3A121JW01#			
	150pF		±5%	GRM31A5C3A151JW01#			
	180pF		±5%	GRM31A5C3A181JW01#			
	220pF		±5%	GRM31A5C3A221JW01#			
1000Vdc	U2J		10pF	±5%	GRM31A7U3A100JW31#		
			12pF	±5%	GRM31A7U3A120JW31#		
			15pF	±5%	GRM31A7U3A150JW31#		
			18pF	±5%	GRM31A7U3A180JW31#		
			22pF	±5%	GRM31A7U3A220JW31#		
			27pF	±5%	GRM31A7U3A270JW31#		
			33pF	±5%	GRM31A7U3A330JW31#		
			39pF	±5%	GRM31A7U3A390JW31#		
			47pF	±5%	GRM31A7U3A470JW31#		
			56pF	±5%	GRM31A7U3A560JW31#		
			68pF	±5%	GRM31A7U3A680JW31#		
			82pF	±5%	GRM31A7U3A820JW31#		
			100pF	±5%	GRM31A7U3A101JW31#		
			120pF	±5%	GRM31A7U3A121JW31#		
		150pF	±5%	GRM31A7U3A151JW31#			
	180pF	±5%	GRM31A7U3A181JW31#				
	220pF	±5%	GRM31A7U3A221JW31#				
	COG	10pF	±5%	GRM31A5C3A100JW01#			
		12pF	±5%	GRM31A5C3A120JW01#			
		15pF	±5%	GRM31A5C3A150JW01#			
		18pF	±5%	GRM31A5C3A180JW01#			
22pF		±5%	GRM31A5C3A220JW01#				
27pF		±5%	GRM31A5C3A270JW01#				

T寸法 最大値	定格 電圧	温度 特性	静電容量	許容差	品番		
1.0mm	1000Vdc	U2J	68pF	±5%	GRM31A7U3A680JW31#		
			82pF	±5%	GRM31A7U3A820JW31#		
			100pF	±5%	GRM31A7U3A101JW31#		
			120pF	±5%	GRM31A7U3A121JW31#		
			150pF	±5%	GRM31A7U3A151JW31#		
			180pF	±5%	GRM31A7U3A181JW31#		
			220pF	±5%	GRM31A7U3A221JW31#		
			270pF	±5%	GRM31A7U3A271JW31#		
			330pF	±5%	GRM31A7U3A331JW31#		
			630Vdc	COG	10pF	±5%	GRM31A5C2J100JW01#
					12pF	±5%	GRM31A5C2J120JW01#
					15pF	±5%	GRM31A5C2J150JW01#
					18pF	±5%	GRM31A5C2J180JW01#
					22pF	±5%	GRM31A5C2J220JW01#
					27pF	±5%	GRM31A5C2J270JW01#
	33pF	±5%			GRM31A5C2J330JW01#		
	39pF	±5%			GRM31A5C2J390JW01#		
	47pF	±5%			GRM31A5C2J470JW01#		
	U2J	56pF		±5%	GRM31A5C2J560JW01#		
		68pF		±5%	GRM31A5C2J680JW01#		
		82pF		±5%	GRM31A5C2J820JW01#		
		100pF		±5%	GRM31A5C2J101JW01#		
		120pF		±5%	GRM31A5C2J121JW01#		
		150pF		±5%	GRM31A5C2J151JW01#		
		180pF		±5%	GRM31A5C2J181JW01#		
		220pF		±5%	GRM31A5C2J221JW01#		
		270pF		±5%	GRM31A5C2J271JW01#		
	630Vdc	COG	330pF	±5%	GRM31A5C2J331JW01#		
			390pF	±5%	GRM31A5C2J391JW01#		
			470pF	±5%	GRM31A5C2J471JW01#		
			560pF	±5%	GRM31A5C2J561JW01#		
			680pF	±5%	GRM31A5C2J681JW01#		
			820pF	±5%	GRM31A5C2J821JW01#		
1000pF			±5%	GRM31A5C2J1001JW01#			
1200pF			±5%	GRM31A5C2J1201JW01#			
1500pF			±5%	GRM31A5C2J1501JW01#			
U2J		1800pF	±5%	GRM31A5C2J1801JW01#			
		2200pF	±5%	GRM31A5C2J2201JW01#			
		2700pF	±5%	GRM31A5C2J2701JW01#			
		3300pF	±5%	GRM31A5C2J3301JW01#			
		3900pF	±5%	GRM31A5C2J3901JW01#			
		4700pF	±5%	GRM31A5C2J4701JW01#			
		5600pF	±5%	GRM31A5C2J5601JW01#			
		6800pF	±5%	GRM31A5C2J6801JW01#			
		8200pF	±5%	GRM31A5C2J8201JW01#			

品番 #には包装仕様コードが入ります。

GRMシリーズ
 GJMシリーズ
 GMAシリーズ
 GMDシリーズ
 GQMシリーズ
 GRJシリーズ
 GR3シリーズ
 KRMシリーズ
 KR3シリーズ
 LLAシリーズ
 LLLシリーズ
 LLMシリーズ
 LLRシリーズ
 △注意/
 使用上の注意

GRMシリーズ 温度補償用 品番表

(→ ■3.2×1.6mm)

T寸法 最大値	定格 電圧	温度 特性	静電容量	許容差	品番	
1.0mm	630Vdc	U2J	820pF	±5%	GRM31A7U2J821JW31#	
			1000pF	±5%	GRM31A7U2J102JW31#	
			1200pF	±5%	GRM31A7U2J122JW31#	
			1500pF	±5%	GRM31A7U2J152JW31#	
			1800pF	±5%	GRM31A7U2J182JW31#	
			2200pF	±5%	GRM31A7U2J222JW31#	
			500Vdc	C0G	10pF	±5%
		12pF	±5%		GRM31A5C2H120JW01#	
		15pF	±5%		GRM31A5C2H150JW01#	
		18pF	±5%		GRM31A5C2H180JW01#	
		22pF	±5%		GRM31A5C2H220JW01#	
		27pF	±5%		GRM31A5C2H270JW01#	
		33pF	±5%		GRM31A5C2H330JW01#	
		39pF	±5%		GRM31A5C2H390JW01#	
	47pF	±5%	GRM31A5C2H470JW01#			
	56pF	±5%	GRM31A5C2H560JW01#			
	68pF	±5%	GRM31A5C2H680JW01#			
	82pF	±5%	GRM31A5C2H820JW01#			
	100pF	±5%	GRM31A5C2H101JW01#			
	120pF	±5%	GRM31A5C2H121JW01#			
	150pF	±5%	GRM31A5C2H151JW01#			
	180pF	±5%	GRM31A5C2H181JW01#			
	220pF	±5%	GRM31A5C2H221JW01#			
	270pF	±5%	GRM31A5C2H271JW01#			
	330pF	±5%	GRM31A5C2H331JW01#			
	390pF	±5%	GRM31A5C2H391JW01#			
	470pF	±5%	GRM31A5C2H471JW01#			
	560pF	±5%	GRM31A5C2H561JW01#			
	U2J	10pF	±5%		GRM31A7U2H100JW31#	
		12pF	±5%		GRM31A7U2H120JW31#	
		15pF	±5%		GRM31A7U2H150JW31#	
		18pF	±5%		GRM31A7U2H180JW31#	
		22pF	±5%		GRM31A7U2H220JW31#	
		27pF	±5%		GRM31A7U2H270JW31#	
		33pF	±5%		GRM31A7U2H330JW31#	
		39pF	±5%		GRM31A7U2H390JW31#	
		47pF	±5%		GRM31A7U2H470JW31#	
		56pF	±5%		GRM31A7U2H560JW31#	
		68pF	±5%		GRM31A7U2H680JW31#	
		82pF	±5%		GRM31A7U2H820JW31#	
		100pF	±5%		GRM31A7U2H101JW31#	
		120pF	±5%		GRM31A7U2H121JW31#	
		150pF	±5%	GRM31A7U2H151JW31#		
		180pF	±5%	GRM31A7U2H181JW31#		
		220pF	±5%	GRM31A7U2H221JW31#		
		270pF	±5%	GRM31A7U2H271JW31#		
		330pF	±5%	GRM31A7U2H331JW31#		
		390pF	±5%	GRM31A7U2H391JW31#		
		470pF	±5%	GRM31A7U2H471JW31#		
		560pF	±5%	GRM31A7U2H561JW31#		
680pF		±5%	GRM31A7U2H681JW31#			
820pF		±5%	GRM31A7U2H821JW31#			
1000pF		±5%	GRM31A7U2H102JW31#			
1200pF		±5%	GRM31A7U2H122JW31#			

T寸法 最大値	定格 電圧	温度 特性	静電容量	許容差	品番	
1.0mm	500Vdc	U2J	1500pF	±5%	GRM31A7U2H152JW31#	
			1800pF	±5%	GRM31A7U2H182JW31#	
			2200pF	±5%	GRM31A7U2H222JW31#	
		250Vdc	U2J	2700pF	±5%	GRM31A7U2E272JW31#
				3300pF	±5%	GRM31A7U2E332JW31#
				3900pF	±5%	GRM31A7U2E392JW31#
	4700pF			±5%	GRM31A7U2E472JW31#	
	5600pF			±5%	GRM31A7U2E562JW31#	
	200Vdc			U2J	2700pF	±5%
		3300pF	±5%		GRM31A7U2D332JW31#	
		3900pF	±5%		GRM31A7U2D392JW31#	
		4700pF	±5%		GRM31A7U2D472JW31#	
		5600pF	±5%		GRM31A7U2D562JW31#	
		1.25mm	1000Vdc		U2J	390pF
	470pF			±5%		GRM31B7U3A471JW31#
	560pF			±5%		GRM31B7U3A561JW31#
	680pF			±5%		GRM31B7U3A681JW31#
	630Vdc		C0G	680pF	±5%	GRM31B5C2J681JW01#
				820pF	±5%	GRM31B5C2J821JW01#
			U2J	1000pF	±5%	GRM31B5C2J102JW01#
				2700pF	±5%	GRM31B7U2J272JW31#
	500Vdc		C0G	680pF	±5%	GRM31B5C2H681JW01#
				820pF	±5%	GRM31B5C2H821JW01#
			U2J	1000pF	±5%	GRM31B5C2H102JW01#
2700pF				±5%	GRM31B7U2H272JW31#	
250Vdc	U2J	3300pF	±5%	GRM31B7U2J332JW31#		
		6800pF	±5%	GRM31B7U2E682JW31#		
		8200pF	±5%	GRM31B7U2E822JW31#		
		10000pF	±5%	GRM31B7U2E103JW31#		
200Vdc	U2J	12000pF	±5%	GRM31B7U2E123JW31#		
		6800pF	±5%	GRM31B7U2D682JW31#		
		8200pF	±5%	GRM31B7U2D822JW31#		
		10000pF	±5%	GRM31B7U2D103JW31#		
50Vdc	CH	47000pF	±5%	GRM31M2C1H473JA01#		
		56000pF	±5%	GRM31M2C1H563JA01#		
	C0G	47000pF	±5%	GRM31M5C1H473JA01#		
		56000pF	±5%	GRM31M5C1H563JA01#		
	SL	68000pF	±5%	GRM31M1X1H683JA01#		
		82000pF	±5%	GRM31M1X1H823JA01#		
	UJ	0.10μF	±5%	GRM31M1X1H104JA01#		
		68000pF	±5%	GRM31M3U1H683JA01#		
	U2J	82000pF	±5%	GRM31M3U1H823JA01#		
		0.10μF	±5%	GRM31M3U1H104JA01#		
		68000pF	±5%	GRM31M7U1H683JA01#		
		82000pF	±5%	GRM31M7U1H823JA01#		
1.8mm	1000Vdc	U2J	820pF	±5%	GRM31C7U3A821JW32#	
			1000pF	±5%	GRM31C7U3A102JW32#	
	630Vdc	U2J	3900pF	±5%	GRM31C7U2J392JW32#	
			4700pF	±5%	GRM31C7U2J472JW32#	
	500Vdc	U2J	3900pF	±5%	GRM31C7U2H392JW32#	
			4700pF	±5%	GRM31C7U2H472JW32#	
	250Vdc	U2J	15000pF	±5%	GRM31C7U2E153JW32#	

品番 #には包装仕様コードが入ります。

GRMシリーズ
 GJMシリーズ
 GMAシリーズ
 GMDシリーズ
 GQMシリーズ
 GRJシリーズ
 GR3シリーズ
 KRMシリーズ
 KR3シリーズ
 LLAシリーズ
 LLLシリーズ
 LLMシリーズ
 LLRシリーズ
 △注意/
 使用上の注意

GRMシリーズ 温度補償用 品番表

(→ ■3.2×1.6mm)

T寸法 最大値	定格 電圧	温度 特性	静電容量	許容差	品番
1.8mm	250Vdc	U2J	18000pF	±5%	GRM31C7U2E183JW32#
			22000pF	±5%	GRM31C7U2E223JW32#
		CH	68000pF	±5%	GRM31C2C1H683JA01#
			82000pF	±5%	GRM31C2C1H823JA01#
			0.10μF	±5%	GRM31C2C1H104JA01#
			C0G	68000pF	±5%
	C0G	82000pF	±5%	GRM31C5C1H823JA01#	
		0.10μF	±5%	GRM31C5C1H104JA01#	
	25Vdc	CH	0.12μF	±5%	GRM31C2C1E124JA01#
		C0G	0.12μF	±5%	GRM31C5C1E124JA01#
	16Vdc	CH	0.12μF	±5%	GRM31C2C1C124JA01#
		C0G	0.12μF	±5%	GRM31C5C1C124JA01#

T寸法 最大値	定格 電圧	温度 特性	静電容量	許容差	品番	
1.0mm	3150Vdc	C0G	12pF	±5%	GRM42A5C3F120JW01#	
			15pF	±5%	GRM42A5C3F150JW01#	
			18pF	±5%	GRM42A5C3F180JW01#	
			22pF	±5%	GRM42A5C3F220JW01#	
			27pF	±5%	GRM42A5C3F270JW01#	
			33pF	±5%	GRM42A5C3F330JW01#	
			39pF	±5%	GRM42A5C3F390JW01#	
			47pF	±5%	GRM42A5C3F470JW01#	
			U2J	10pF	±5%	GRM42A7U3F100JW31#
				12pF	±5%	GRM42A7U3F120JW31#
				15pF	±5%	GRM42A7U3F150JW31#
				18pF	±5%	GRM42A7U3F180JW31#
		22pF		±5%	GRM42A7U3F220JW31#	
		27pF		±5%	GRM42A7U3F270JW31#	
		33pF	±5%	GRM42A7U3F330JW31#		
			39pF	±5%	GRM42A7U3F390JW31#	
			47pF	±5%	GRM42A7U3F470JW31#	
			56pF	±5%	GRM42A7U3F560JW31#	
	68pF		±5%	GRM42A7U3F680JW31#		
	82pF		±5%	GRM42A7U3F820JW31#		
	100pF	±5%	GRM42A7U3F101JW31#			

■3.2×2.5mm

T寸法 最大値	定格 電圧	温度 特性	静電容量	許容差	品番	
1.0mm	2000Vdc	U2J	82pF	±5%	GRM32A7U3D820JW31#	
			100pF	±5%	GRM32A7U3D101JW31#	
			120pF	±5%	GRM32A7U3D121JW31#	
			150pF	±5%	GRM32A7U3D151JW31#	
	630Vdc	U2J	1200pF	±5%	GRM32A7U2J122JW31#	
			1500pF	±5%	GRM32A7U2J152JW31#	
			1800pF	±5%	GRM32A7U2J182JW31#	
			2200pF	±5%	GRM32A7U2J222JW31#	
	500Vdc	U2J	1200pF	±5%	GRM32A7U2H122JW31#	
			1500pF	±5%	GRM32A7U2H152JW31#	
			1800pF	±5%	GRM32A7U2H182JW31#	
			2200pF	±5%	GRM32A7U2H222JW31#	
	1.25mm	2000Vdc	U2J	180pF	±5%	GRM32B7U3D181JW31#
				220pF	±5%	GRM32B7U3D221JW31#
		1000Vdc	U2J	1200pF	±5%	GRM32B7U3A122JW31#
				630Vdc	U2J	5600pF
500Vdc	U2J	5600pF	±5%	GRM32B7U2H562JW31#		
		1.5mm	1000Vdc	U2J	1500pF	±5%
630Vdc	U2J	6800pF			±5%	GRM32Q7U2J682JW31#
500Vdc	U2J	6800pF			±5%	GRM32Q7U2H682JW31#
250Vdc	U2J	27000pF			±5%	GRM32Q7U2E273JW31#
2.0mm	1000Vdc	U2J	1800pF	±5%	GRM32D7U3A182JW31#	
			2200pF	±5%	GRM32D7U3A222JW31#	
	630Vdc	U2J	8200pF	±5%	GRM32D7U2J822JW31#	
			10000pF	±5%	GRM32D7U2J103JW31#	
	500Vdc	U2J	8200pF	±5%	GRM32D7U2H822JW31#	
			10000pF	±5%	GRM32D7U2H103JW31#	
	250Vdc	U2J	33000pF	±5%	GRM32D7U2E333JW31#	
			39000pF	±5%	GRM32D7U2E393JW31#	
			47000pF	±5%	GRM32D7U2E473JW31#	

■4.5×2.0mm

T寸法 最大値	定格 電圧	温度 特性	静電容量	許容差	品番
1.0mm	3150Vdc	C0G	5.0pF	±0.5pF	GRM42A5C3F050DW01#
			10pF	±5%	GRM42A5C3F100JW01#

■4.5×3.2mm

T寸法 最大値	定格 電圧	温度 特性	静電容量	許容差	品番	
1.5mm	1000Vdc	U2J	2700pF	±5%	GRM43Q7U3A272JW31#	
			3300pF	±5%	GRM43Q7U3A332JW31#	
	630Vdc	U2J	12000pF	±5%	GRM43Q7U2J123JW31#	
			500Vdc	U2J	12000pF	±5%
	2.0mm	1000Vdc	U2J	3900pF	±5%	GRM43D7U3A392JW31#
				4700pF	±5%	GRM43D7U3A472JW31#
630Vdc		U2J	15000pF	±5%	GRM43D7U2J153JW31#	
			18000pF	±5%	GRM43D7U2J183JW31#	
500Vdc	U2J	22000pF	±5%	GRM43D7U2J223JW31#		
		15000pF	±5%	GRM43D7U2H153JW31#		
	18000pF	±5%	GRM43D7U2H183JW31#			
		22000pF	±5%	GRM43D7U2H223JW31#		

■5.7×5.0mm

T寸法 最大値	定格 電圧	温度 特性	静電容量	許容差	品番	
1.5mm	1000Vdc	U2J	5600pF	±5%	GRM55Q7U3A562JW31#	
			6800pF	±5%	GRM55Q7U3A682JW31#	
	630Vdc	U2J	27000pF	±5%	GRM55Q7U2J273JW31#	
			500Vdc	U2J	27000pF	±5%
2.0mm	1000Vdc	U2J	8200pF	±5%	GRM55D7U3A822JW31#	
			10000pF	±5%	GRM55D7U3A103JW31#	
		630Vdc	U2J	33000pF	±5%	GRM55D7U2J333JW31#
				39000pF	±5%	GRM55D7U2J393JW31#
	500Vdc	U2J	47000pF	±5%	GRM55D7U2J473JW31#	
			33000pF	±5%	GRM55D7U2H333JW31#	
		39000pF	±5%	GRM55D7U2H393JW31#		

品番 #には包装仕様コードが入ります。

GRMシリーズ
 GJMシリーズ
 GMAシリーズ
 GMDシリーズ
 GOMシリーズ
 GRJシリーズ
 GR3シリーズ
 KRMシリーズ
 KR3シリーズ
 LLAシリーズ
 LLLシリーズ
 LLMシリーズ
 LLRシリーズ
 △注意/
 使用上の注意

△お願い：製品によっては、お守りいただかないと発煙、発火等にいたる可能性のある定格や△注意（保管・使用環境、定格上の注意、実装上の注意、取扱上の注意）を記載しておりますので、必ずご覧下さい。
 ・当カタログには、代表的な仕様しか記載しておりませんので、ご注文にあたっては詳細な仕様が記載されている納入仕様書の内容をご確認いただくか承認図の取交しをお願いします。

GRMシリーズ 温度補償用 品番表

(→ ■5.7×5.0mm)

T寸法 最大値	定格 電圧	温度 特性	静電容量	許容差	品番
2.0mm	500Vdc	U2J	47000pF	±5%	GRM55D7U2H473JW31#

GRMシリーズ

GJMシリーズ

GMAシリーズ

GMDシリーズ

GQMシリーズ

GRJシリーズ

GR3シリーズ

KRMシリーズ

KR3シリーズ

LLAシリーズ

LLLシリーズ

LLMシリーズ

LLRシリーズ

△注意/
使用上の注意

品番 #には包装仕様コードが入ります。

GRMシリーズ 高誘電率系 品番表

■0.4×0.2mm 超小型

T寸法 最大値	定格 電圧	温度 特性	静電容量	許容差	品番	
0.22mm	16Vdc	X7R	100pF	±10%	GRM022R71C101KE14#	
				±20%	GRM022R71C101ME14#	
			150pF	±10%	GRM022R71C151KE14#	
				±20%	GRM022R71C151ME14#	
			220pF	±10%	GRM022R71C221KE14#	
				±20%	GRM022R71C221ME14#	
		330pF	±10%	GRM022R71C331KE14#		
			±20%	GRM022R71C331ME14#		
		470pF	±10%	GRM022R71C471KE14#		
			±20%	GRM022R71C471ME14#		
		1000pF	±10%	GRM022R71C102KE14#		
			±20%	GRM022R71C102ME14#		
	10Vdc	X7R	100pF	±10%	GRM022R71A101KA01#	
				±20%	GRM022R71A101MA01#	
			150pF	±10%	GRM022R71A151KA01#	
				±20%	GRM022R71A151MA01#	
			220pF	±10%	GRM022R71A221KA01#	
				±20%	GRM022R71A221MA01#	
		330pF	±10%	GRM022R71A331KA01#		
			±20%	GRM022R71A331MA01#		
		470pF	±10%	GRM022R71A471KA01#		
			±20%	GRM022R71A471MA01#		
		680pF	±10%	GRM022R71A681KA12#		
			±20%	GRM022R71A681MA12#		
820pF		±10%	GRM022R71A821KA12#			
		±20%	GRM022R71A821MA12#			
1000pF		±10%	GRM022R71A102KA12#			
		±20%	GRM022R71A102MA12#			
B		100pF	±10%	GRM022B11A101KA01#		
			±20%	GRM022B11A101MA01#		
	150pF	±10%	GRM022B11A151KA01#			
		±20%	GRM022B11A151MA01#			
	220pF	±10%	GRM022B11A221KA01#			
		±20%	GRM022B11A221MA01#			
	330pF	±10%	GRM022B11A331KA01#			
		±20%	GRM022B11A331MA01#			
	470pF	±10%	GRM022B11A471KA01#			
		±20%	GRM022B11A471MA01#			
	680pF	±10%	GRM022B31A681KE19#			
		±20%	GRM022B31A681ME19#			
1000pF	±10%	GRM022B31A102KE19#				
	±20%	GRM022B31A102ME19#				
1500pF	±10%	GRM022B31A152KE19#				
	±20%	GRM022B31A152ME19#				
2200pF	±10%	GRM022B31A222KE19#				
	±20%	GRM022B31A222ME19#				
3300pF	±10%	GRM022B31A332KE19#				
	±20%	GRM022B31A332ME19#				
4700pF	±10%	GRM022B31A472KE19#				
	±20%	GRM022B31A472ME19#				
6800pF	±10%	GRM022B31A682KE19#				
	±20%	GRM022B31A682ME19#				

T寸法 最大値	定格 電圧	温度 特性	静電容量	許容差	品番	
0.22mm	10Vdc	B	1000pF	±10%	GRM022B31A103KE19#	
				±20%	GRM022B31A103ME19#	
			100pF	±10%	GRM022R61A101KA01#	
				±20%	GRM022R61A101MA01#	
			150pF	±10%	GRM022R61A151KA01#	
				±20%	GRM022R61A151MA01#	
		220pF	±10%	GRM022R61A221KA01#		
			±20%	GRM022R61A221MA01#		
		330pF	±10%	GRM022R61A331KA01#		
			±20%	GRM022R61A331MA01#		
		470pF	±10%	GRM022R61A471KA01#		
			±20%	GRM022R61A471MA01#		
	680pF	±10%	GRM022R61A681KE19#			
		±20%	GRM022R61A681ME19#			
	1000pF	±10%	GRM022R61A102KE19#			
		±20%	GRM022R61A102ME19#			
	6.3Vdc	B	1000pF	±10%	GRM022R61A152KE19#	
				±20%	GRM022R61A152ME19#	
			2200pF	±10%	GRM022R61A222KE19#	
				±20%	GRM022R61A222ME19#	
			3300pF	±10%	GRM022R61A332KE19#	
				±20%	GRM022R61A332ME19#	
		4700pF	±10%	GRM022R61A472KE19#		
			±20%	GRM022R61A472ME19#		
6800pF		±10%	GRM022R61A682KE19#			
		±20%	GRM022R61A682ME19#			
10000pF		±10%	GRM022R61A103KE19#			
		±20%	GRM022R61A103ME19#			
4Vdc	X6T	1000pF	±20%	GRM022B30J102ME19#		
			±20%	GRM022B30J152ME19#		
		2200pF	±20%	GRM022B30J222ME19#		
			±20%	GRM022B30J332ME19#		
		4700pF	±20%	GRM022B30J472ME19#		
			±20%	GRM022B30J682ME19#		
	10000pF	±20%	GRM022B30J103ME19#			
		±20%	GRM022B30J153ME15#			
	X5R	1000pF	±20%	GRM022B30J223KE15#		
			±20%	GRM022B30J223ME15#		
		3300pF	±20%	GRM022B30J333ME15#		
			±20%	GRM022B30J473ME15#		
6800pF		±20%	GRM022B30J683ME15#			
		±20%	GRM022B30J104ME15#			
0.10μF	±20%	GRM022D80G104ME15#				
	±20%	GRM022D80G153KE15#				
15000pF	±10%	GRM022R60G153KE15#				
	±20%	GRM022R60G153ME15#				
22000pF	±10%	GRM022R60G223KE15#				
	±20%	GRM022R60G223ME15#				

品番 #には包装仕様コードが入ります。

GRMシリーズ
GJMシリーズ
GMAシリーズ
GMDシリーズ
GQMシリーズ
GRJシリーズ
GR3シリーズ
KRMシリーズ
KR3シリーズ
LLAシリーズ
LLLシリーズ
LLMシリーズ
LLRシリーズ
△注意/
使用上の注意

△お願い ・製品によっては、お守りいただかないと発煙、発火等にいたる可能性のある定格や△注意（保管・使用環境、定格上の注意、実装上の注意、取扱上の注意）を記載しておりますので、必ずご覧下さい。
 ・当カタログには、代表的な仕様しか記載しておりませんので、ご注文にあたっては詳細な仕様が記載されている納入仕様書の内容をご確認いただくか承認図の取交しをお願いします。

GRMシリーズ 高誘電率系 品番表

(→ ■0.4×0.2mm)

T寸法 最大値	定格 電圧	温度 特性	静電容量	許容差	品番	
0.22mm	4Vdc	X5R	33000pF	±10%	GRM022R60G333KE15#	
				±20%	GRM022R60G333ME15#	
			47000pF	±10%	GRM022R60G473KE15#	
				±20%	GRM022R60G473ME15#	
			68000pF	±20%	GRM022R60G683ME15#	
				0.10μF	±20%	GRM022R60G104ME15#
2.5Vdc	X6T	0.10μF	±20%	GRM022D80E104ME15#		

T寸法 最大値	定格 電圧	温度 特性	静電容量	許容差	品番			
0.33mm	25Vdc	X7R	1000pF	±10%	GRM033R71E102KA01#			
				±20%	GRM033R71E152KA01#			
			1500pF	±10%	GRM033R71E222KA12#			
				±20%	GRM033R71E222MA12#			
			2200pF	±10%	GRM033R71E332KA12#			
				±20%	GRM033R71E332MA12#			
			3300pF	±10%	GRM033R71E472KE14#	Derating		
				±20%	GRM033R71E472ME14#	Derating		
			4700pF	±10%	GRM033R71E682KE14#	Derating		
				±20%	GRM033R71E682ME14#	Derating		
			6800pF	±10%	GRM033R71E103KE14#	Derating		
				±20%	GRM033R71E103ME14#	Derating		
			10000pF	±10%	GRM033R71E104KE14#	Derating		
				±20%	GRM033R71E104ME14#	Derating		
			X6S	0.10μF	±10%	GRM033C81E104KE14#	Derating	
		±20%				GRM033C81E104ME14#	Derating	
		B			1000pF	±10%	GRM033B11E102KA01#	
						±20%	GRM033B11E102MA01#	
		1500pF			±10%	GRM033B11E152KA01#		
					±20%	GRM033B11E152MA01#		
		2200pF			±10%	GRM033B31E222KA12#		
					±20%	GRM033B31E222MA12#		
		3300pF			±10%	GRM033B31E332KA12#		
					±20%	GRM033B31E332MA12#		
		10000pF			±10%	GRM033B31E103KA12#	Derating	
					±20%	GRM033B31E103MA12#	Derating	
		X5R			4700pF	±10%	GRM033R61E472KA12#	Derating
						±20%	GRM033R61E472MA12#	Derating
						6800pF	±10%	GRM033R61E682KA12#
			±20%	GRM033R61E682MA12#			Derating	
10000pF	±10%		GRM033R61E103KA12#	Derating				
	±20%		GRM033R61E103MA12#	Derating				
16Vdc	R	2200pF	±10%	GRM033R11C222KA88#				
			±20%	GRM033R11C222MA88#				
		3300pF	±10%	GRM033R11C332KA88#				
			±20%	GRM033R11C332MA88#				
		X7R	2200pF	±10%	GRM033R71C222KA88#			
				±20%	GRM033R71C222MA88#			
	3300pF	±10%	GRM033R71C332KA88#					
		±20%	GRM033R71C332MA88#					
	4700pF	±10%	GRM033R71C472KE14#	Derating				
		±20%	GRM033R71C472ME14#	Derating				
	6800pF	±10%	GRM033R71C682KE14#	Derating				
		±20%	GRM033R71C682ME14#	Derating				
10000pF	±10%	GRM033R71C103KE14#	Derating					
	±20%	GRM033R71C103ME14#	Derating					
X7S	0.10μF	±10%	GRM033C71C104KE14#	Derating				
		±20%	GRM033C71C104ME14#	Derating				
X6S	0.10μF	±10%	GRM033C81C104KE14#					
			±20%	GRM033C81C104ME14#				
		B	2200pF	±10%	GRM033B31C222KA87#			
				±20%	GRM033B31C222MA87#			
		3300pF	±10%	GRM033B31C332KA87#				
			±20%	GRM033B31C332MA87#				
10000pF	±10%	GRM033B31C103KA12#						
	±20%	GRM033B31C103MA12#						
15000pF	±10%	GRM033B31C153KE84#	Derating					
	±20%	GRM033B31C153ME84#	Derating					

■0.6×0.3mm 超小型

T寸法 最大値	定格 電圧	温度 特性	静電容量	許容差	品番				
0.33mm	50Vdc	X7R	100pF	±10%	GRM033R71H101KA12#				
				±20%	GRM033R71H101MA12#				
			150pF	±10%	GRM033R71H151KA12#				
				±20%	GRM033R71H151MA12#				
			220pF	±10%	GRM033R71H221KA12#				
				±20%	GRM033R71H221MA12#				
			330pF	±10%	GRM033R71H331KA12#				
				±20%	GRM033R71H331MA12#				
			470pF	±10%	GRM033R71H471KA12#				
				±20%	GRM033R71H471MA12#				
			680pF	±10%	GRM033R71H681KA12#				
				±20%	GRM033R71H681MA12#				
			1000pF	±10%	GRM033R71H102KA12#				
				±20%	GRM033R71H102MA12#				
			1500pF	±10%	GRM033R71H152KA12#				
				±20%	GRM033R71H152MA12#				
			B	100pF	±10%	GRM033B31H101KA12#			
						±20%	GRM033B31H101MA12#		
					150pF	±10%	GRM033B31H151KA12#		
						±20%	GRM033B31H151MA12#		
					220pF	±10%	GRM033B31H221KA12#		
		±20%				GRM033B31H221MA12#			
		330pF			±10%	GRM033B31H331KA12#			
					±20%	GRM033B31H331MA12#			
		470pF			±10%	GRM033B31H471KA12#			
					±20%	GRM033B31H471MA12#			
		680pF			±10%	GRM033B31H681KA12#			
					±20%	GRM033B31H681MA12#			
		1000pF			±10%	GRM033B31H102KA12#			
					±20%	GRM033B31H102MA12#			
		1500pF			±10%	GRM033B31H152KA12#			
			±20%	GRM033B31H152MA12#					
		35Vdc	X5R	0.10μF	±10%	GRM033R6YA104KE14#	Derating		
					±20%	GRM033R6YA104ME14#	Derating		
				25Vdc	R	100pF	±10%	GRM033R11E101KA01#	
						150pF	±10%	GRM033R11E151KA01#	
		220pF	±10%	GRM033R11E221KA01#					
		330pF	±10%	GRM033R11E331KA01#					
		470pF	±10%	GRM033R11E471KA01#					
		680pF	±10%	GRM033R11E681KA01#					
		1000pF	±10%	GRM033R11E102KA01#					
		1500pF	±10%	GRM033R11E152KA01#					

品番 #には包装仕様コードが入ります。

GRMシリーズ
GJMシリーズ
GMAシリーズ
GMDシリーズ
GQMシリーズ
GRJシリーズ
GRSシリーズ
KRMシリーズ
KRSシリーズ
LLAシリーズ
LLLシリーズ
LLMシリーズ
LLRシリーズ
△注意/
使用上の注意

GRMシリーズ 高誘電率系 品番表

(→ ■0.6×0.3mm)

T寸法 最大値	定格 電圧	温度 特性	静電容量	許容差	品番		
0.33mm	16Vdc	B	22000pF	±10%	GRM033B31C223KE84#		
				±20%	GRM033B31C223ME84#		
			33000pF	±10%	GRM033B31C333KE84#		
				±20%	GRM033B31C333ME84#		
			47000pF	±10%	GRM033B31C473KE84#		
				±20%	GRM033B31C473ME84#		
			68000pF	±10%	GRM033B31C683KE84#		
				±20%	GRM033B31C683ME84#		
			0.10μF	±10%	GRM033B31C104KE84#		
				±20%	GRM033B31C104ME84#		
			X5R	10000pF	±10%	GRM033R61C103KA12#	
					±20%	GRM033R61C103MA12#	
		15000pF		±10%	GRM033R61C153KE84#		
				±20%	GRM033R61C153ME84#		
		22000pF		±10%	GRM033R61C223KE84#		
				±20%	GRM033R61C223ME84#		
		33000pF		±10%	GRM033R61C333KE84#		
				±20%	GRM033R61C333ME84#		
		47000pF		±10%	GRM033R61C473KE84#		
				±20%	GRM033R61C473ME84#		
		68000pF		±10%	GRM033R61C683KE84#		
				±20%	GRM033R61C683ME84#		
		0.10μF	±10%	GRM033R61C104KE14#			
			±20%	GRM033R61C104ME14#			
	10Vdc	R	4700pF	±10%	GRM033R11A472KA01#		
				±20%	GRM033R11A472MA01#		
			6800pF	±10%	GRM033R11A682KA01#		
				±20%	GRM033R11A682MA01#		
			10000pF	±10%	GRM033R11A103KA01#		
				±20%	GRM033R11A103MA01#		
			X7R	4700pF	±10%	GRM033R71A472KA01#	
					±20%	GRM033R71A472MA01#	
				6800pF	±10%	GRM033R71A682KA01#	
					±20%	GRM033R71A682MA01#	
				10000pF	±10%	GRM033R71A103KA01#	
					±20%	GRM033R71A103MA01#	
		X7S	0.10μF	±10%	GRM033C71A104KE14#		
				±20%	GRM033C71A104ME14#		
		B	4700pF	±10%	GRM033B11A472KA01#		
				±20%	GRM033B11A472MA01#		
			6800pF	±10%	GRM033B11A682KA01#		
				±20%	GRM033B11A682MA01#		
			15000pF	±10%	GRM033B31A153KE84#		
				±20%	GRM033B31A153ME84#		
			22000pF	±10%	GRM033B31A223KE84#		
				±20%	GRM033B31A223ME84#		
			33000pF	±10%	GRM033B31A333KE84#		
				±20%	GRM033B31A333ME84#		
47000pF	±10%		GRM033B31A473KE84#				
	±20%		GRM033B31A473ME84#				
68000pF	±10%	GRM033B31A683KE84#					
	±20%	GRM033B31A683ME84#					
0.10μF	±10%	GRM033B31A104KE84#					
	±20%	GRM033B31A104ME84#					

T寸法 最大値	定格 電圧	温度 特性	静電容量	許容差	品番		
0.33mm	10Vdc	X5R	4700pF	±10%	GRM033R61A472KA01#		
				±20%	GRM033R61A472MA01#		
			6800pF	±10%	GRM033R61A682KA01#		
				±20%	GRM033R61A682MA01#		
			15000pF	±10%	GRM033R61A153KE84#		
				±20%	GRM033R61A153ME84#		
			22000pF	±10%	GRM033R61A223KE84#		
				±20%	GRM033R61A223ME84#		
			33000pF	±10%	GRM033R61A333KE84#		
				±20%	GRM033R61A333ME84#		
			47000pF	±10%	GRM033R61A473KE84#		
				±20%	GRM033R61A473ME84#		
		68000pF	±10%	GRM033R61A683KE84#			
			±20%	GRM033R61A683ME84#			
		0.10μF	±10%	GRM033R61A104KE84#			
			±20%	GRM033R61A104ME84#			
		0.22μF	±20%	GRM033R61A224ME90#			
			6.3Vdc	R	4700pF	±10%	GRM033R10J472KA01#
		±20%				GRM033R10J472MA01#	
		10000pF			±10%	GRM033R10J103KA01#	
		X7R		4700pF	±10%	GRM033R70J472KA01#	
					±20%	GRM033R70J472MA01#	
				10000pF	±10%	GRM033R70J103KA01#	
		X6S	15000pF	±10%	GRM033C80J153KE01#		
	±20%			GRM033C80J153ME01#			
	22000pF		±10%	GRM033C80J223KE01#			
			±20%	GRM033C80J223ME01#			
	33000pF		±10%	GRM033C80J333KE01#			
			±20%	GRM033C80J333ME01#			
	47000pF	±10%	GRM033C80J473KE19#				
	B	68000pF	±10%	GRM033C80J683KE84#			
			±20%	GRM033C80J683ME84#			
		0.10μF	±10%	GRM033C80J104KE84#			
			±20%	GRM033C80J104ME84#			
		0.22μF	±20%	GRM033C80J224ME90#			
			4Vdc	X5R	4700pF	±10%	GRM033B10J472KA01#
	±20%	GRM033B10J472MA01#					
	6800pF	±10%			GRM033B10J682KA01#		
		±20%			GRM033B10J682MA01#		
	15000pF	±10%			GRM033B10J153KE01#		
		±20%			GRM033B10J153ME01#		
	22000pF	±10%		GRM033B10J223KE01#			
		±20%		GRM033B10J223ME01#			
	33000pF	±10%		GRM033B10J333KE01#			
		±20%		GRM033B10J333ME01#			
	X6S	0.22μF		±20%	GRM033R60J224ME90#		
				±20%	GRM033C80G224ME90#		

■ 1.0×0.5mm

T寸法 最大値	定格 電圧	温度 特性	静電容量	許容差	品番	
0.22mm	10Vdc	B	0.10μF	±10%	GRM152B31A104KE19#	
				±20%	GRM152B31A104ME19#	
			0.22μF	±10%	GRM152B31A224KE19#	

品番 #には包装仕様コードが入ります。

GRMシリーズ
GJMシリーズ
GMAシリーズ
GMDシリーズ
GQMシリーズ
GRJシリーズ
GR3シリーズ
KRMシリーズ
KR3シリーズ
LLAシリーズ
LLLシリーズ
LLMシリーズ
LLRシリーズ
△注意/
使用上の注意

GRMシリーズ 高誘電率系 品番表

(→ ■ 1.0×0.5mm)

T寸法 最大値	定格 電圧	温度 特性	静電容量	許容差	品番			
0.22mm	10Vdc	B	0.22μF	±20%	GRM152B31A224ME19#			
				±10%	GRM152R61A104KE19#			
			±20%	GRM152R61A104ME19#				
		X5R	0.10μF	±10%	GRM152R61A104ME19#			
				±20%	GRM152R61A224KE19#			
			±20%	GRM152R61A224ME19#				
	6.3Vdc	X6S	0.10μF	±10%	GRM152C80J104KE19#			
				±20%	GRM152C80J104ME19#			
				±10%	GRM152C80J224KE19#			
			0.22μF	±10%	GRM152C80J224ME19#			
				±20%	GRM152C80J224ME19#			
				±10%	GRM152C80J224ME19#			
		B	0.10μF	±10%	GRM152B30J104KE19#			
				±20%	GRM152B30J104ME19#			
				±10%	GRM152B30J224KE19#			
			0.22μF	±10%	GRM152B30J224ME19#			
				±20%	GRM152B30J224ME19#			
				±10%	GRM152B30J474ME15#			
	X5R	0.10μF	±10%	GRM152R60J104KE19#				
			±20%	GRM152R60J104ME19#				
			±10%	GRM152R60J224KE19#				
		0.22μF	±10%	GRM152R60J224ME19#				
			±20%	GRM152R60J224ME19#				
			±10%	GRM152R60J474ME15#				
4Vdc	X7T	0.10μF	±10%	GRM152D70G104KE15#				
			±20%	GRM152D70G104ME15#				
			±10%	GRM152D70G224KE15#				
		0.22μF	±10%	GRM152D70G224ME15#				
			±20%	GRM152D70G224ME15#				
			±10%	GRM152D70G224ME15#				
	X6S	0.10μF	±10%	GRM152C80G104KE19#				
			±20%	GRM152C80G104ME19#				
			±10%	GRM152C80G224KE19#				
		0.22μF	±10%	GRM152C80G224ME19#				
			±20%	GRM152C80G224ME19#				
			±10%	GRM152C80G224ME19#				
	X6T	0.47μF	±20%	GRM152D80G474ME15#				
		1.0μF	±20%	GRM152D80G105ME15#				
		1.0μF	±20%	GRM152R60G105ME15#				
	2.5Vdc	X7T	0.10μF	±10%	GRM152D70E104KE19#			
				±20%	GRM152D70E104ME19#			
				±10%	GRM152D70E224KE19#			
0.22μF			±10%	GRM152D70E224ME19#				
			±20%	GRM152D70E224ME19#				
			±10%	GRM152D70E224ME19#				
0.3mm	50Vdc	R	220pF	±10%	GRM15XR11H221KA86#			
			330pF	±10%	GRM15XR11H331KA86#			
			470pF	±10%	GRM15XR11H471KA86#			
			680pF	±10%	GRM15XR11H681KA86#			
			1000pF	±10%	GRM15XR11H102KA86#			
			1500pF	±10%	GRM15XR11H152KA86#			
			X7R	220pF	±10%	GRM15XR71H221KA86#		
				330pF	±10%	GRM15XR71H331KA86#		
				470pF	±10%	GRM15XR71H471KA86#		
				680pF	±10%	GRM15XR71H681KA86#		
				1000pF	±10%	GRM15XR71H102KA86#		
				1500pF	±10%	GRM15XR71H152KA86#		
		B	220pF	±10%	GRM15XB11H221KA86#			
				±20%	GRM15XB11H221MA86#			
				±10%	GRM15XB11H331KA86#			
			330pF	±10%	GRM15XB11H331MA86#			
				±20%	GRM15XB11H331MA86#			
				±10%	GRM15XB11H471KA86#			
		470pF	±10%	GRM15XB11H471MA86#				
			±20%	GRM15XB11H471MA86#				
			±10%	GRM15XB11H681KA86#				
			±20%	GRM15XB11H681MA86#				
			±10%	GRM15XB11H102KA86#				
			±20%	GRM15XB11H102MA86#				
0.3mm	50Vdc	B	680pF	±20%	GRM15XB11H681MA86#			
			1000pF	±10%	GRM15XB11H102KA86#			
			±20%	GRM15XB11H102MA86#				
				1500pF	±10%	GRM15XB11H152KA86#		
			±20%	GRM15XB11H152MA86#				
				25Vdc	X7R	2200pF	±10%	GRM15XR71E222KA86#
			±20%				GRM15XR71E222MA86#	
			±10%			GRM15XB11E222KA86#		
			B		2200pF	±10%	GRM15XB11E222MA86#	
						±20%	GRM15XB11E222MA86#	
					±10%	GRM15XR71C332KA86#		
			16Vdc	X7R	3300pF	±10%	GRM15XR71C332KA86#	
		±20%				GRM15XR71C332MA86#		
		±10%				GRM15XR71C472KA86#		
		4700pF			±10%	GRM15XR71C472MA86#		
					±20%	GRM15XR71C472MA86#		
					±10%	GRM15XR71C682KA86#		
		B		3300pF	±10%	GRM15XB11C332KA86#		
					±20%	GRM15XB11C332MA86#		
					±10%	GRM15XB11C472KA86#		
				4700pF	±10%	GRM15XB11C472MA86#		
					±20%	GRM15XB11C472MA86#		
					±10%	GRM15XB11C682KA86#		
		10Vdc	X5R	15000pF	±10%	GRM15XR61A153KA86#		
±20%	GRM15XR61A153MA86#							
±10%	GRM15XR61A223KA86#							
22000pF	±10%			GRM15XR61A223MA86#				
	±20%			GRM15XR61A223MA86#				
	±10%			GRM15XR61A333KA86#				
33000pF	±10%		GRM15XR61A333MA86#					
	±20%		GRM15XR61A333MA86#					
	0.33mm		10Vdc	B	1.0μF	±20%	GRM153B31A105ME95#	
					X5R	1.0μF	±20%	GRM153R61A105ME95#
				6.3Vdc	X6T	1.0μF	±20%	GRM153D80J105ME95#
			4Vdc	B	1.0μF	±20%	GRM153B30J105ME95#	
X5R		1.0μF			±20%	GRM153R60J105ME95#		
X6T		1.0μF		±20%	GRM153D80G105ME95#			
0.55mm	100Vdc	X7R	220pF	±10%	GRM155R72A221KA01#			
			330pF	±10%	GRM155R72A331KA01#			
			470pF	±10%	GRM155R72A471KA01#			
			680pF	±10%	GRM155R72A681KA01#			
			1000pF	±10%	GRM155R72A102KA01#			
			1500pF	±10%	GRM155R72A152KA01#			
			2200pF	±10%	GRM155R72A222KA01#			
			3300pF	±10%	GRM155R72A332KA01#			
			4700pF	±10%	GRM155R72A472KA01#			
			50Vdc	R	220pF	±10%	GRM155R11H221KA01#	
					330pF	±10%	GRM155R11H331KA01#	
					470pF	±10%	GRM155R11H471KA01#	
	680pF	±10%			GRM155R11H681KA01#			
	1000pF	±10%			GRM155R11H102KA01#			
	1500pF	±10%			GRM155R11H152KA01#			
	2200pF	±10%			GRM155R11H222KA01#			
	3300pF	±10%			GRM155R11H332KA01#			

T寸法 最大値	定格 電圧	温度 特性	静電容量	許容差	品番			
0.3mm	50Vdc	B	680pF	±20%	GRM15XB11H681MA86#			
				±10%	GRM15XB11H102KA86#			
			±20%	GRM15XB11H102MA86#				
				1500pF	±10%	GRM15XB11H152KA86#		
			±20%	GRM15XB11H152MA86#				
				25Vdc	X7R	2200pF	±10%	GRM15XR71E222KA86#
			±20%				GRM15XR71E222MA86#	
			±10%			GRM15XB11E222KA86#		
			B		2200pF	±10%	GRM15XB11E222MA86#	
						±20%	GRM15XB11E222MA86#	
					±10%	GRM15XR71C332KA86#		
			16Vdc	X7R	3300pF	±10%	GRM15XR71C332KA86#	
		±20%				GRM15XR71C332MA86#		
		±10%				GRM15XR71C472KA86#		
		4700pF			±10%	GRM15XR71C472MA86#		
					±20%	GRM15XR71C472MA86#		
					±10%	GRM15XR71C682KA86#		
		B		3300pF	±10%	GRM15XB11C332KA86#		
					±20%	GRM15XB11C332MA86#		
					±10%	GRM15XB11C472KA86#		
				4700pF	±10%	GRM15XB11C472MA86#		
					±20%	GRM15XB11C472MA86#		
					±10%	GRM15XB11C682KA86#		
		10Vdc	X5R	15000pF	±10%	GRM15XR61A153KA86#		
±20%	GRM15XR61A153MA86#							
±10%	GRM15XR61A223KA86#							
22000pF	±10%			GRM15XR61A223MA86#				
	±20%			GRM15XR61A223MA86#				
	±10%			GRM15XR61A333KA86#				
33000pF	±10%		GRM15XR61A333MA86#					
	±20%		GRM15XR61A333MA86#					
	0.33mm		10Vdc	B	1.0μF	±20%	GRM153B31A105ME95#	
					X5R	1.0μF	±20%	GRM153R61A105ME95#
				6.3Vdc	X6T	1.0μF	±20%	GRM153D80J105ME95#
			4Vdc	B	1.0μF	±20%	GRM153B30J105ME95#	
X5R		1.0μF			±20%	GRM153R60J105ME95#		
X6T		1.0μF		±20%	GRM153D80G105ME95#			
0.55mm	100Vdc	X7R	220pF	±10%	GRM155R72A221KA01#			
			330pF	±10%	GRM155R72A331KA01#			
			470pF	±10%	GRM155R72A471KA01#			
			680pF	±10%	GRM155R72A681KA01#			
			1000pF	±10%	GRM155R72A102KA01#			
			1500pF	±10%	GRM155R72A152KA01#			
			2200pF	±10%	GRM155R72A222KA01#			
			3300pF	±10%	GRM155R72A332KA01#			
			4700pF	±10%	GRM155R72A472KA01#			
			50Vdc	R	220pF	±10%	GRM155R11H221KA01#	
					330pF	±10%	GRM155R11H331KA01#	
					470pF	±10%	GRM155R11H471KA01#	
		680pF			±10%	GRM155R11H681KA01#		
		1000pF			±10%	GRM155R11H102KA01#		
		1500pF			±10%	GRM155R11H152KA01#		
		2200pF			±10%	GRM155R11H222KA01#		
		3300pF			±10%	GRM155R11H332KA01#		

品番 #には包装仕様コードが入ります。

GRMシリーズ
 GJMシリーズ
 GMAシリーズ
 GMDシリーズ
 GQMシリーズ
 GRJシリーズ
 GR3シリーズ
 KRMシリーズ
 KR3シリーズ
 LLAシリーズ
 LLLシリーズ
 LLMシリーズ
 LLRシリーズ
 △注意/
 使用上の注意

GRMシリーズ 高誘電率系 品番表

(→ ■ 1.0×0.5mm)

T寸法 最大値	定格 電圧	温度 特性	静電容量	許容差	品番
0.55mm	50Vdc	R	4700pF	±10%	GRM155R11H472KA01#
			6800pF	±10%	GRM155R11H682KA88#
			10000pF	±10%	GRM155R11H103KA88#
		X7R	220pF	±10%	GRM155R71H221KA01#
			330pF	±10%	GRM155R71H331KA01#
			470pF	±10%	GRM155R71H471KA01#
			680pF	±10%	GRM155R71H681KA01#
			1000pF	±10%	GRM155R71H102KA01#
			1500pF	±10%	GRM155R71H152KA01#
			2200pF	±10%	GRM155R71H222KA01#
			3300pF	±10%	GRM155R71H332KA01#
			4700pF	±10%	GRM155R71H472KA01#
			6800pF	±10%	GRM155R71H682KA88#
			10000pF	±10%	GRM155R71H103KA88#
			15000pF	±10%	GRM155R71H153KA12#
			22000pF	±10%	GRM155R71H223KA12#
			33000pF	±10%	GRM155R71H333KE14#
				±20%	GRM155R71H333ME14#
		47000pF	±10%	GRM155R71H473KE14#	
			±20%	GRM155R71H473ME14#	
		68000pF	±10%	GRM155R71H683KE14#	
			±20%	GRM155R71H683ME14#	
		0.10μF	±10%	GRM155R71H104KE14#	
			±20%	GRM155R71H104ME14#	
		X6S	33000pF	±10%	GRM155C81H333KE14#
				±20%	GRM155C81H333ME14#
			47000pF	±10%	GRM155C81H473KE14#
			±20%	GRM155C81H473ME14#	
		68000pF	±10%	GRM155C81H683KE14#	
			±20%	GRM155C81H683ME14#	
		B	220pF	±10%	GRM155B11H221KA01#
				±20%	GRM155B11H221MA01#
			330pF	±10%	GRM155B11H331KA01#
				±20%	GRM155B11H331MA01#
			470pF	±10%	GRM155B11H471KA01#
				±20%	GRM155B11H471MA01#
			680pF	±10%	GRM155B11H681KA01#
				±20%	GRM155B11H681MA01#
			1000pF	±10%	GRM155B11H102KA01#
				±20%	GRM155B11H102MA01#
			1500pF	±10%	GRM155B11H152KA01#
				±20%	GRM155B11H152MA01#
			2200pF	±10%	GRM155B11H222KA01#
				±20%	GRM155B11H222MA01#
			3300pF	±10%	GRM155B11H332KA01#
				±20%	GRM155B11H332MA01#
			4700pF	±10%	GRM155B11H472KA01#
				±20%	GRM155B11H472MA01#
		6800pF	±10%	GRM155B31H682KA88#	
			±20%	GRM155B31H682MA88#	
		10000pF	±10%	GRM155B31H103KA88#	
			±20%	GRM155B31H103MA88#	
		15000pF	±10%	GRM155B31H153KA12#	
			±20%	GRM155B31H153MA12#	

T寸法 最大値	定格 電圧	温度 特性	静電容量	許容差	品番	
0.55mm	50Vdc	B	22000pF	±10%	GRM155B31H223KA12#	
				±20%	GRM155B31H223MA12#	
			0.10μF	±10%	GRM155B31H104KE14#	
				±20%	GRM155B31H104ME14#	
			X5R	33000pF	±10%	GRM155R61H333KE14#
					±20%	GRM155R61H333ME14#
		47000pF		±10%	GRM155R61H473KE14#	
				±20%	GRM155R61H473ME14#	
		68000pF		±10%	GRM155R61H683KE14#	
				±20%	GRM155R61H683ME14#	
		0.10μF	±10%	GRM155R61H104KE14#		
			±20%	GRM155R61H104ME14#		
		35Vdc	X6S	0.22μF	±10%	GRM155C8YA224KE01#
					±20%	GRM155C8YA224ME01#
			X5R	0.22μF	±10%	GRM155R6YA224KE01#
					±20%	GRM155R6YA224ME01#
			0.47μF	±10%	GRM155R6YA474KE01#	
				±20%	GRM155R6YA474ME01#	
		25Vdc	R	6800pF	±10%	GRM155R11E682KA01#
				10000pF	±10%	GRM155R11E103KA01#
				15000pF	±10%	GRM155R11E153KA61#
				22000pF	±10%	GRM155R11E223KA61#
				33000pF	±10%	GRM155R11E333KA88#
				47000pF	±10%	GRM155R11E473KA88#
			X7R	10000pF	±10%	GRM155R71E103KA01#
				15000pF	±10%	GRM155R71E153KA61#
				22000pF	±10%	GRM155R71E223KA61#
				33000pF	±10%	GRM155R71E333KA88#
				47000pF	±10%	GRM155R71E473KA88#
				68000pF	±10%	GRM155R71E683KE14#
				±20%	GRM155R71E683ME14#	
			0.10μF	±10%	GRM155R71E104KE14#	
				±20%	GRM155R71E104ME14#	
			X6S	0.22μF	±10%	GRM155C81E224KE01#
					±20%	GRM155C81E224ME01#
			B	10000pF	±10%	GRM155B11E103KA01#
				±20%	GRM155B11E103MA01#	
		15000pF		±10%	GRM155B11E153KA61#	
				±20%	GRM155B11E153MA61#	
		22000pF		±10%	GRM155B11E223KA61#	
				±20%	GRM155B11E223MA61#	
		33000pF	±10%	GRM155B31E333KA87#		
			±20%	GRM155B31E333MA87#		
		47000pF	±10%	GRM155B31E473KA87#		
			±20%	GRM155B31E473MA87#		
		68000pF	±10%	GRM155B31E683KA87#		
			±20%	GRM155B31E683MA87#		
		0.10μF	±10%	GRM155B31E104KA87#		
			±20%	GRM155B31E104MA87#		
		1.0μF	±10%	GRM155B31E105KA12#		
			±20%	GRM155B31E105MA12#		
		X5R	68000pF	±10%	GRM155R61E683KA87#	
				±20%	GRM155R61E683MA87#	
		0.10μF	±10%	GRM155R61E104KA87#		

品番 #には包装仕様コードが入ります。

GRMシリーズ
 GJMシリーズ
 GMAシリーズ
 GMDシリーズ
 GGMシリーズ
 GRJシリーズ
 GR3シリーズ
 KRMシリーズ
 KR3シリーズ
 LLAシリーズ
 LLLシリーズ
 LLMシリーズ
 LLRシリーズ
 △注意/
 使用上の注意

GRMシリーズ 高誘電率系 品番表

(→ ■ 1.0×0.5mm)

T寸法 最大値	定格 電圧	温度 特性	静電容量	許容差	品番			
0.55mm	25Vdc	X5R	0.10μF	±20%	GRM155R61E104MA87#			
				±10%	GRM155R61E224KE01#			
			±20%	GRM155R61E224ME01#				
			0.47μF	±10%	GRM155R61E474KE01#			
				±20%	GRM155R61E474ME01#			
			1.0μF	±10%	GRM155R61E105KA12#	Derating		
		±20%		GRM155R61E105MA12#	Derating			
		16Vdc	R	68000pF	±10%	GRM155R11C683KA88#		
					±20%	GRM155R11C683MA88#		
				X7R	68000pF	±10%	GRM155R71C683KA88#	
						±20%	GRM155R71C683MA88#	
				0.15μF	±10%	GRM155R71C154KA12#		
	±20%				GRM155R71C154MA12#			
			0.22μF	±10%	GRM155R71C224KA12#			
				±20%	GRM155R71C224MA12#			
	X6S		0.47μF	±10%	GRM155C81C474KE01#			
				±20%	GRM155C81C474ME01#			
	B		1.0μF	±10%	GRM155B31C105KA12#			
				±20%	GRM155B31C105MA12#			
	X5R		0.22μF	±10%	GRM155R61C224KA12#			
				±20%	GRM155R61C224MA12#			
			0.47μF	±10%	GRM155R61C474KE01#			
				±20%	GRM155R61C474ME01#			
			1.0μF	±10%	GRM155R61C105KA12#			
				±20%	GRM155R61C105MA12#			
	10Vdc	X7R	0.22μF	±10%	GRM155R71A224KE01#			
				±20%	GRM155R71A224ME01#			
			0.47μF	±10%	GRM155R71A474KE01#			
				±20%	GRM155R71A474ME01#			
			X6S	1.0μF	±10%	GRM155C81A105KA12#		
					±20%	GRM155C81A105MA12#		
		B	0.15μF	±10%	GRM155B31A154KE18#			
				±20%	GRM155B31A154ME18#			
			0.22μF	±10%	GRM155B31A224KE18#			
				±20%	GRM155B31A224ME18#			
			0.33μF	±10%	GRM155B31A334KE14#			
				±20%	GRM155B31A334ME14#			
		0.47μF	±10%	GRM155B31A474KE14#				
			±20%	GRM155B31A474ME14#				
		0.68μF	±10%	GRM155B31A684KE15#				
				±20%	GRM155B31A684ME15#			
			2.2μF	±10%	GRM155B31A225KE95#	Derating		
±20%				GRM155B31A225ME95#	Derating			
X5R			0.15μF	±10%	GRM155R61A154KE19#			
				±20%	GRM155R61A154ME19#			
		0.22μF	±10%	GRM155R61A224KE19#				
			±20%	GRM155R61A224ME19#				
		0.33μF	±10%	GRM155R61A334KE15#				
			±20%	GRM155R61A334ME15#				
	0.47μF	±10%	GRM155R61A474KE15#					
		±20%	GRM155R61A474ME15#					
	0.68μF	±10%	GRM155R61A684KE15#					
		±20%	GRM155R61A684ME15#					
	6.3Vdc	X7R	1.0μF	±10%	GRM155R70J105KA12#	Derating		
				±20%	GRM155R70J105MA12#	Derating		
X6S		2.2μF	±10%	GRM155C80J225KE95#	Derating			
			±20%	GRM155C80J225ME95#	Derating			
B		0.15μF	±10%	GRM155B10J154KE01#				

T寸法 最大値	定格 電圧	温度 特性	静電容量	許容差	品番		
0.55mm	6.3Vdc	B	0.15μF	±20%	GRM155B10J154ME01#		
				±10%	GRM155B10J224KE01#		
			±20%	GRM155B10J224ME01#			
			0.33μF	±10%	GRM155B10J334KE01#		
				±20%	GRM155B10J334ME01#		
			0.47μF	±10%	GRM155B30J474KE18#		
		±20%		GRM155B30J474ME18#			
		0.68μF	±10%	GRM155B30J684KE18#			
			±20%	GRM155B30J684ME18#			
		X5R	2.2μF	±10%	GRM155B30J225KE95#		
				±20%	GRM155B30J225ME95#		
			0.15μF	±10%	GRM155R60J154KE01#		
				±20%	GRM155R60J154ME01#		
			0.22μF	±10%	GRM155R60J224KE01#		
				±20%	GRM155R60J224ME01#		
		0.33μF	±10%	GRM155R60J334KE01#			
			±20%	GRM155R60J334ME01#			
		4Vdc	X7R	1.0μF	±10%	GRM155R70G105KA12#	
	±20%				GRM155R70G105MA12#		
	X5R		1.0μF	±10%	GRM155R6YA105KE11#	Derating	
				±20%	GRM155R6YA105ME11#	Derating	
	X6S		1.0μF	±10%	GRM155C81E105KE11#	Derating	
				±20%	GRM155C81E105ME11#	Derating	
	X6S	1.0μF	±10%	GRM155C81C105KE11#			
			±20%	GRM155C81C105ME11#			
	6.3Vdc	B	4.7μF	±20%	GRM155B30J475ME47#	Derating	
				±10%	GRM155R60J475ME47#	Derating	
	4Vdc	B	4.7μF	±20%	GRM155B30G475ME47#		
				±10%	GRM155R60G475ME47#		
	2.5Vdc	X6T	4.7μF	±20%	GRM155D80E475ME47#	Derating	
				±10%	GRM155C80J475MEAA#	Derating	
	0.65mm	6.3Vdc	X6S	4.7μF	±20%	GRM155C80J475MEAA#	Derating
					±10%	GRM155R61E225KE11#	
		16Vdc	X6S	2.2μF	±10%	GRM155C81C225KE11#	
					±20%	GRM155C81C225ME11#	
		X5R	2.2μF	±10%	GRM155R61C225KE11#		
±20%				GRM155R61C225ME11#			
10Vdc	X7S	2.2μF	±10%	GRM155C71A225KE11#			
			±20%	GRM155C71A225ME11#			
X6S	2.2μF	±10%	GRM155C81A225KE11#				
		±20%	GRM155C81A225ME11#				
6.3Vdc	X7S	2.2μF	±10%	GRM155C70J225KE11#			
			±20%	GRM155C70J225ME11#			
4Vdc	X5R	10μF	±20%	GRM155R60G106ME44#			
			±10%	GRM155R60E106ME16#			

品番 #には包装仕様コードが入ります。

GRMシリーズ
GJMシリーズ
GMAシリーズ
GMDシリーズ
GQMシリーズ
GRJシリーズ
GR3シリーズ
KRMシリーズ
KR3シリーズ
LLAシリーズ
LLLシリーズ
LLMシリーズ
LLRシリーズ
△注意/
使用上の注意

GRMシリーズ 高誘電率系 品番表

■ 1.6×0.8mm

T寸法 最大値	定格 電圧	温度 特性	静電容量	許容差	品番			
0.5mm	25Vdc	B	1.0μF	±10%	GRM185B31E105KA12#	Derating		
				±20%	GRM185B31E105MA12#	Derating		
			X5R	1.0μF	±10%	GRM185R61E105KA12#	Derating	
		±20%			GRM185R61E105MA12#	Derating		
		16Vdc		B	1.0μF	±10%	GRM185B31C105KE43#	
			±20%			GRM185B31C105ME43#		
	X5R		1.0μF		±10%	GRM185R61C105KE44#		
		±20%		GRM185R61C105ME44#				
		6.3Vdc	X5R	10μF	±20%	GRM185R60J106ME15#	Derating	
	4Vdc	X5R	10μF	±20%	GRM185R60G106ME15#			
	0.55mm	16Vdc	X5R	4.7μF	±10%	GRM185R61C475KE11#		
					±20%	GRM185R61C475ME11#		
10Vdc				X6S	4.7μF	±10%	GRM185C81A475KE11#	Derating
			±20%			GRM185C81A475ME11#	Derating	
			X5R		4.7μF	±10%	GRM185R61A475KE11#	
±20%				GRM185R61A475ME11#				
6.3Vdc		X7T		4.7μF	±20%	GRM185D70J475ME11#	Derating	
		X6S	4.7μF	±20%	GRM185C80J475ME11#			
0.9mm		250Vdc	X7R	220pF	±10%	GRM188R72E221KW07#		
					±20%	GRM188R72E222KW07#		
				330pF	±10%	GRM188R72E331KW07#		
					±20%	GRM188R72E332KW07#		
	470pF			±10%	GRM188R72E471KW07#			
				±20%	GRM188R72E472KW07#			
	680pF			±10%	GRM188R72E681KW07#			
				±20%	GRM188R72E682KW07#			
	1000pF			±10%	GRM188R72E102KW07#			
				±20%	GRM188R72E103KW07#			
	1500pF			±10%	GRM188R72E152KW07#			
				±20%	GRM188R72E153KW07#			
	2200pF		±10%	GRM188R72E222KW07#				
			±20%	GRM188R72E223KW07#				
	200Vdc		X7R	220pF	±10%	GRM188R72D221KW07#		
					±20%	GRM188R72D222KW07#		
				330pF	±10%	GRM188R72D331KW07#		
					±20%	GRM188R72D332KW07#		
				470pF	±10%	GRM188R72D471KW07#		
					±20%	GRM188R72D472KW07#		
			100Vdc	X7R	220pF	±10%	GRM188R72A221KA01#	
						±20%	GRM188R72A222KA01#	
					330pF	±10%	GRM188R72A331KA01#	
				±20%		GRM188R72A332KA01#		
		470pF		±10%		GRM188R72A471KA01#		
				±20%	GRM188R72A472KA01#			
	680pF		±10%	GRM188R72A681KA01#				
		±20%	GRM188R72A682KA01#					
		1000pF	±10%	GRM188R72A102KA01#				
	±20%		GRM188R72A103KA01#					
	1500pF		±10%	GRM188R72A152KAC4#				
		±20%	GRM188R72A153MAC4#					
		2200pF	±10%	GRM188R72A223KAC4#				
	±20%		GRM188R72A223MAC4#					
	0.10μF		±10%	GRM188R72A104KA35#				
	50Vdc	R	220pF	±10%	GRM188R11H221KA01#			
				±20%	GRM188R11H222KA01#			
			330pF	±10%	GRM188R11H331KA01#			
				±20%	GRM188R11H332KA01#			
			470pF	±10%	GRM188R11H471KA01#			
				±20%	GRM188R11H472KA01#			
			680pF	±10%	GRM188R11H681KA01#			
				±20%	GRM188R11H682KA01#			

T寸法 最大値	定格 電圧	温度 特性	静電容量	許容差	品番	
0.9mm	50Vdc	R	1000pF	±10%	GRM188R11H102KA01#	
				±20%	GRM188R11H103KA01#	
			1500pF	±10%	GRM188R11H152KA01#	
				±20%	GRM188R11H153KA01#	
			2200pF	±10%	GRM188R11H222KA01#	
				±20%	GRM188R11H223KA01#	
			3300pF	±10%	GRM188R11H332KA01#	
				±20%	GRM188R11H333KA01#	
			4700pF	±10%	GRM188R11H472KA01#	
				±20%	GRM188R11H473KA01#	
			6800pF	±10%	GRM188R11H682KA01#	
				±20%	GRM188R11H683KA01#	
			10000pF	±10%	GRM188R11H103KA01#	
				±20%	GRM188R11H104KA01#	
			15000pF	±10%	GRM188R11H153KA01#	
				±20%	GRM188R11H154KAC4#	
			22000pF	±10%	GRM188R11H223KA01#	
				±20%	GRM188R11H224KAC4#	
			33000pF	±10%	GRM188R11H333KA01#	
				±20%	GRM188R11H334KAC4#	
			47000pF	±10%	GRM188R11H473KA01#	
				±20%	GRM188R11H474KAC4#	
			68000pF	±10%	GRM188R11H683KA01#	
				±20%	GRM188R11H684KAC4#	
		X7R	0.10μF	±10%	GRM188R11H104KA93#	
				±20%	GRM188R11H105KA93#	
			220pF	±10%	GRM188R71H221KA01#	
				±20%	GRM188R71H222KA01#	
			330pF	±10%	GRM188R71H331KA01#	
				±20%	GRM188R71H332KA01#	
			470pF	±10%	GRM188R71H471KA01#	
				±20%	GRM188R71H472KA01#	
			680pF	±10%	GRM188R71H681KA01#	
				±20%	GRM188R71H682KA01#	
			1000pF	±10%	GRM188R71H102KA01#	
				±20%	GRM188R71H103KA01#	
			1500pF	±10%	GRM188R71H152KA01#	
				±20%	GRM188R71H153KA01#	
			2200pF	±10%	GRM188R71H222KA01#	
				±20%	GRM188R71H223KA01#	
			3300pF	±10%	GRM188R71H332KA01#	
				±20%	GRM188R71H333KA01#	
			4700pF	±10%	GRM188R71H472KA01#	
				±20%	GRM188R71H473KA01#	
			6800pF	±10%	GRM188R71H682KA01#	
				±20%	GRM188R71H683KA01#	
			10000pF	±10%	GRM188R71H103KA01#	
				±20%	GRM188R71H104KA01#	
15000pF	±10%	GRM188R71H153KA01#				
	±20%	GRM188R71H154KAC4#				
22000pF	±10%	GRM188R71H223KA01#				
	±20%	GRM188R71H224KAC4#				
33000pF	±10%	GRM188R71H333KA01#				
	±20%	GRM188R71H334KAC4#				
47000pF	±10%	GRM188R71H473KA01#				
	±20%	GRM188R71H474KAC4#				
68000pF	±10%	GRM188R71H683KA01#				
	±20%	GRM188R71H684KAC4#				
B	220pF	±10%	GRM188B11H221KA01#			
		±20%	GRM188B11H222MA01#			
	330pF	±10%	GRM188B11H331KA01#			
		±20%	GRM188B11H332MA01#			
	470pF	±10%	GRM188B11H471KA01#			
		±20%	GRM188B11H472MA01#			
	680pF	±10%	GRM188B11H681KA01#			
		±20%	GRM188B11H682MA01#			
	1000pF	±10%	GRM188B11H102KA01#			
		±20%	GRM188B11H103MA01#			
	1500pF	±10%	GRM188B11H152KA01#			
		±20%	GRM188B11H153MA01#			
	2200pF	±10%	GRM188B11H222KA01#			
		±20%	GRM188B11H223MA01#			
	3300pF	±10%	GRM188B11H332KA01#			
		±20%	GRM188B11H333MA01#			
	4700pF	±10%	GRM188B11H472KA01#			
		±20%	GRM188B11H473MA01#			
	6800pF	±10%	GRM188B11H682KA01#			
		±20%	GRM188B11H683MA01#			

品番 #には包装仕様コードが入ります。

GRMシリーズ
 GJMシリーズ
 GMAシリーズ
 GMDシリーズ
 GDMシリーズ
 GRJシリーズ
 GR3シリーズ
 KRMシリーズ
 KR3シリーズ
 LLAシリーズ
 LLLシリーズ
 LLMシリーズ
 LLRシリーズ
 △注意/
 使用上の注意

GRMシリーズ 高誘電率系 品番表

(→ ■ 1.6×0.8mm)

T寸法 最大値	定格 電圧	温度 特性	静電容量	許容差	品番	
0.9mm	50Vdc	B	10000pF	±10%	GRM188B11H103KA01#	
				±20%	GRM188B11H103MA01#	
			15000pF	±10%	GRM188B11H153KA01#	
				±20%	GRM188B11H153MA01#	
			22000pF	±10%	GRM188B11H223KA01#	
				±20%	GRM188B11H223MA01#	
			33000pF	±10%	GRM188B11H333KA61#	
				±20%	GRM188B11H333MA61#	
			47000pF	±10%	GRM188B11H473KA61#	
				±20%	GRM188B11H473MA61#	
			68000pF	±10%	GRM188B31H683KA92#	
				±20%	GRM188B31H683MA92#	
			0.10μF	±10%	GRM188B31H104KA92#	
				±20%	GRM188B31H104MA92#	
			0.15μF	±10%	GRM188B31H154KAC4#	
				±20%	GRM188B31H154MAC4#	
			0.22μF	±10%	GRM188B31H224KAC4#	
				±20%	GRM188B31H224MAC4#	
			1.0μF	±10%	GRM188B31H105KAAL#	
				±20%	GRM188B31H105MAAL#	
			X5R	0.22μF	±10%	GRM188R61H224KAC4#
					±20%	GRM188R61H224MA12#
				0.47μF	±10%	GRM188R61H474KA12#
					±20%	GRM188R61H474MA12#
	1.0μF	±10%		GRM188R61H105KAAL#		
		±20%		GRM188R61H105MAAL#		
	25Vdc	R	33000pF	±10%	GRM188R11E333KA01#	
			47000pF	±10%	GRM188R11E473KA01#	
			68000pF	±10%	GRM188R11E683KA01#	
			0.15μF	±10%	GRM188R11E154KA01#	
			0.22μF	±10%	GRM188R11E224KA88#	
			X7R	33000pF	±10%	GRM188R71E333KA01#
		47000pF		±10%	GRM188R71E473KA01#	
		68000pF		±10%	GRM188R71E683KA01#	
		0.15μF		±10%	GRM188R71E154KA01#	
		0.22μF		±10%	GRM188R71E224KA88#	
		0.47μF		±10%	GRM188R71E474KA12#	
		±20%	GRM188R71E474MA12#			
	1.0μF		±10%	GRM188R71E105KA12#		
	±20%	GRM188R71E105MA12#				
	B	10000pF	±10%	GRM188B11E103KA01#		
			±20%	GRM188B11E103MA01#		
			15000pF	±10%	GRM188B11E153KA01#	
				±20%	GRM188B11E153MA01#	
			22000pF	±10%	GRM188B11E223KA01#	
				±20%	GRM188B11E223MA01#	
		33000pF	±10%	GRM188B11E333KA01#		
			±20%	GRM188B11E333MA01#		
47000pF		±10%	GRM188B11E473KA01#			
		±20%	GRM188B11E473MA01#			
68000pF		±10%	GRM188B11E683KA01#			
		±20%	GRM188B11E683MA01#			
0.10μF		±10%	GRM188B11E104KA01#			
±20%		GRM188B11E104MA01#				
0.15μF		±10%	GRM188B11E154KA01#			

T寸法 最大値	定格 電圧	温度 特性	静電容量	許容差	品番	
0.9mm	25Vdc	B	0.22μF	±10%	GRM188B31E224KA87#	
				±20%	GRM188B31E224MA75#	
			0.47μF	±10%	GRM188B31E474KA75#	
				±20%	GRM188B31E474MA75#	
			0.68μF	±10%	GRM188B31E684KA75#	
				±20%	GRM188B31E684MA75#	
			1.0μF	±10%	GRM188B31E105KA75#	
				±20%	GRM188B31E105MA75#	
			2.2μF	±10%	GRM188B31E225KA12#	
				±20%	GRM188B31E225MA12#	
			X5R	0.22μF	±10%	GRM188R61E224KA88#
					±20%	GRM188R61E224MA12#
		0.47μF		±10%	GRM188R61E474KA12#	
				±20%	GRM188R61E474MA12#	
		0.68μF		±10%	GRM188R61E684KA75#	
				±20%	GRM188R61E684MA75#	
		1.0μF	±10%	GRM188R61E105KA12#		
			±20%	GRM188R61E105MA12#		
		2.2μF	±10%	GRM188R61E225KA12#		
			±20%	GRM188R61E225MA12#		
		16Vdc	R	0.33μF	±10%	GRM188R11C334KA01#
				0.47μF	±10%	GRM188R11C474KA88#
			X7R	0.15μF	±10%	GRM188R71C154KA01#
				0.22μF	±10%	GRM188R71C224KA01#
	0.33μF			±10%	GRM188R71C334KA01#	
	0.47μF			±10%	GRM188R71C474KA88#	
	1.0μF		±10%	GRM188R71C105KE15#		
			±20%	GRM188R71C105ME15#		
	X7S		0.68μF	±10%	GRM188R71C684KA12#	
			±20%	GRM188R71C684MA12#		
	X6S		2.2μF	±10%	GRM188R81C225KA12#	
				±20%	GRM188R81C225MA12#	
		B	0.33μF	±10%	GRM188B11C334KA01#	
			±20%	GRM188B11C334MA01#		
	0.68μF	±10%	GRM188B31C684KA75#			
		±20%	GRM188B31C684MA75#			
	2.2μF	±10%	GRM188B31C225KE14#			
		±20%	GRM188B31C225ME15#			
	X5R	0.68μF	±10%	GRM188R61C684KA75#		
			±20%	GRM188R61C684MA75#		
		2.2μF	±10%	GRM188R61C225KE15#		
			±20%	GRM188R61C225ME15#		
	10Vdc	X7R	0.33μF	±10%	GRM188R71A334KA61#	
				±20%	GRM188R71A334MA61#	
			0.68μF	±10%	GRM188R71A684KA61#	
				±20%	GRM188R71A684MA61#	
			2.2μF	±10%	GRM188R71A225KE15#	
				±20%	GRM188R71A225ME15#	
X7T		2.2μF	±10%	GRM188D71A225KE34#		
			±20%	GRM188D71A225ME34#		
B		0.33μF	±10%	GRM188B11A334KA61#		
			±20%	GRM188B11A334MA61#		
X5R		0.33μF	±10%	GRM188R61A334KA61#		
			±20%	GRM188R61A334MA61#		
6.3Vdc	B	10μF	±20%	GRM188B30J106ME47#		
0.95mm	25Vdc	X5R	4.7μF	±10%	GRM188R61E475KE11#	
			±20%	GRM188R61E475ME11#		
	16Vdc	X6S	4.7μF	±10%	GRM188R81C475KE11#	

品番 #には包装仕様コードが入ります。

GRMシリーズ
GJMシリーズ
GMAシリーズ
GMDシリーズ
GQMシリーズ
GRJシリーズ
GR3シリーズ
KRMシリーズ
KR3シリーズ
LLAシリーズ
LLLシリーズ
LLMシリーズ
LLRシリーズ
△注意/
使用上の注意

GRMシリーズ 高誘電率系 品番表

(→ ■ 1.6×0.8mm)

T寸法 最大値	定格 電圧	温度 特性	静電容量	許容差	品番	
0.95mm	16Vdc	X6S	4.7μF	±20%	GRM188C81C475ME11#	
				±10%	GRM188B31C475KAAJ#	Derating
				±20%	GRM188B31C475MAAJ#	Derating
		X5R	4.7μF	±10%	GRM188R61C475KE11#	
				±20%	GRM188R61C475ME11#	
				±10%	GRM188R61C106KAAL#	
	10Vdc	X7S	4.7μF	±10%	GRM188C71A475KE11#	
				±20%	GRM188C71A475ME11#	
				±20%	GRM188B31A106ME69#	Derating
		X5R	10μF	±10%	GRM188R61A106KAAL#	
				±20%	GRM188R61A106MAAL#	
				±20%	GRM188R61A106MAAL#	
1.0mm	50Vdc	X5R	2.2μF	±10%	GRM188R61H225KE11#	
				±20%	GRM188R61H225ME11#	
				±10%	GRM188C8YA225KE11#	
		X6S	2.2μF	±10%	GRM188C8YA225ME11#	
				±20%	GRM188C8YA225ME11#	
				±10%	GRM188R6YA475KE15#	
	25Vdc	X7S	2.2μF	±10%	GRM188C71E225KE11#	
				±20%	GRM188C71E225ME11#	
				±10%	GRM188C81E225KE11#	
		X6S	2.2μF	±10%	GRM188C81E225ME11#	
				±20%	GRM188C81E225ME11#	
				±10%	GRM188C81E475KE11#	Derating
	16Vdc	X7S	2.2μF	±10%	GRM188C71C225KE11#	
				±20%	GRM188C71C225ME11#	
				±20%	GRM188R61E106MA73#	
		X6S	10μF	±20%	GRM188C81C106MA73#	
				±20%	GRM188C81C106MA73#	
				±20%	GRM188D71A106MA73#	
10Vdc	X7T	10μF	±20%	GRM188D70J106MA73#		
			±20%	GRM188B30J226MEA0#	Derating	
			±20%	GRM188R60J226MEA0#	Derating	
	X5R	22μF	±20%	GRM188C80G226MEA0#	Derating	
			±20%	GRM188B30G226MEA0#	Derating	
			±20%	GRM188R60G226MEA0#	Derating	

■ 2.0×1.25mm

T寸法 最大値	定格 電圧	温度 特性	静電容量	許容差	品番	
0.7mm	16Vdc	X6S	1.0μF	±10%	GRM216C81C105KA12#	
0.95mm	100Vdc	X7R	10000pF	±10%	GRM219R72A103KA01#	
				±20%	GRM219R72A103MA01#	
				±10%	GRM219R11H333KA01#	
		X7R	10000pF	±10%	GRM219R71H103KA01#	
				±20%	GRM219R71H103MA01#	
				±10%	GRM219R71H153KA01#	
	50Vdc	R	33000pF	±10%	GRM219R71H153MA01#	
				±20%	GRM219R71H153MA01#	
				±10%	GRM219R71H333KA01#	
		X7R	15000pF	±10%	GRM219R71H333KA01#	
				±20%	GRM219R71H333KA01#	
				±10%	GRM219R71H334KA88#	
B	0.33μF	±10%	GRM219B31H334KA87#			
		±20%	GRM219B31H334MA87#			
		±10%	GRM219B31H105KA73#			
	1.0μF	±10%	GRM219B31H105KA73#			
		±20%	GRM219B31H105MA73#			
		±20%	GRM219B31H105MA73#			

T寸法 最大値	定格 電圧	温度 特性	静電容量	許容差	品番		
0.95mm	50Vdc	B	2.2μF	±10%	GRM219B31H225KE15#		
				±20%	GRM219B31H225ME15#		
				±10%	GRM219R61H105KA73#		
			X5R	1.0μF	±10%	GRM219R61H105MA73#	
					±20%	GRM219R61H225KE15#	
					±20%	GRM219R61H225ME15#	
		35Vdc	X6S	2.2μF	±10%	GRM219C8YA225KE15#	
					±20%	GRM219C8YA225ME15#	
					±10%	GRM219R6YA475KA73#	Derating
			X5R	4.7μF	±10%	GRM219R6YA475MA73#	Derating
					±20%	GRM219R6YA475MA73#	Derating
					±10%	GRM219R11E683KA01#	
	25Vdc	R	68000pF	±10%	GRM219R11E683KA01#		
				±10%	GRM219R71E104KA01#		
				±20%	GRM219R71E104MA01#		
			X7R	0.10μF	±10%	GRM219R71E684KA88#	
					±10%	GRM219R71E105KA88#	
					±10%	GRM219R71E105KA88#	
		X6S	2.2μF	±10%	GRM219C81E225KE15#		
				±20%	GRM219C81E225ME15#		
				±10%	GRM219B31E225KA75#		
			B	2.2μF	±10%	GRM219B31E225MA75#	
					±20%	GRM219B31E106KA12#	Derating
					±20%	GRM219B31E106MA12#	Derating
	X5R	2.2μF	±10%	GRM219R61E225KA12#			
			±20%	GRM219R61E225MA12#			
			±10%	GRM219R61E475KA73#			
		4.7μF	±10%	GRM219R61E475MA73#			
			±20%	GRM219R61E106KA12#	Derating		
			±20%	GRM219R61E106MA12#	Derating		
	16Vdc	R	0.68μF	±10%	GRM219R11C684KA01#		
				±10%	GRM219R71C334KA88#		
				±10%	GRM219R71C225KE15#		
			X6S	4.7μF	±10%	GRM219C81C475KA73#	
					±20%	GRM219C81C475MA73#	
					±10%	GRM219B31C475KE15#	
B		4.7μF	±10%	GRM219B31C106KA73#			
			±20%	GRM219B31C106MA73#			
			±10%	GRM219R61C475KE15#			
		X5R	4.7μF	±10%	GRM219R61C106KA73#		
				±20%	GRM219R61C106MA73#		
				±20%	GRM219R61C106MA73#		
10Vdc	X7R	2.2μF	±10%	GRM219R71A225KE15#			
			±20%	GRM219R71A225ME15#			
			±10%	GRM219D71A475KE15#	Derating		
	X7T	4.7μF	±10%	GRM219D71A475ME15#	Derating		
			±20%	GRM219B31A226MEA0#	Derating		
			±20%	GRM219R61A226MEA0#	Derating		
6.3Vdc	X6S	10μF	±10%	GRM219C80J106KE39#			
			±20%	GRM219C80J106ME39#			
			±20%	GRM219B30J226ME47#	Derating		
	X5R	22μF	±20%	GRM219R60J226ME47#	Derating		
			±10%	GRM219C80G106KE19#			
			±20%	GRM219C80G106ME19#			
4Vdc	X6S	10μF	±10%	GRM219C80G106ME19#			
			±20%	GRM219C80G106ME19#			
			±20%	GRM219R60G476ME44#	Derating		
	X5R	47μF	±20%	GRM219R60G476ME44#	Derating		
			±20%	GRM219D80E476ME44#			
			±20%	GRM219D80E476ME44#			
1.0mm	250Vdc	X7R	1000pF	±10%	GRM21AR72E102KW01#		

品番 #には包装仕様コードが入ります。

GRMシリーズ
 GJMシリーズ
 GMAシリーズ
 GMDシリーズ
 GQMシリーズ
 GRJシリーズ
 GR3シリーズ
 KRMシリーズ
 KR3シリーズ
 LLAシリーズ
 LLシリーズ
 LLMシリーズ
 LLRシリーズ
 △注意/
 使用上の注意

GRMシリーズ 高誘電率系 品番表

(→ ■2.0×1.25mm)

T寸法 最大値	定格 電圧	温度 特性	静電容量	許容差	品番			
1.0mm	250Vdc	X7R	1500pF	±10%	GRM21AR72E152KW01#			
			2200pF	±10%	GRM21AR72E222KW01#			
			3300pF	±10%	GRM21AR72E332KW01#			
			4700pF	±10%	GRM21AR72E472KW01#			
			6800pF	±10%	GRM21AR72E682KW01#			
	200Vdc	X7R	1000pF	±10%	GRM21AR72D102KW01#			
			1500pF	±10%	GRM21AR72D152KW01#			
			2200pF	±10%	GRM21AR72D222KW01#			
			3300pF	±10%	GRM21AR72D332KW01#			
			4700pF	±10%	GRM21AR72D472KW01#			
	100Vdc	X7R	0.22μF	±10%	GRM21AR72A224KAC5#			
			0.33μF	±10%	GRM21AR72A334KAC5#			
	50Vdc	X7R	22000pF	±10%	GRM219R71H223KA17#			
				±20%	GRM219R71H223MA17#			
	35Vdc	X6S	4.7μF	±10%	GRM219C8YA475KE21#	Derating		
				±20%	GRM219C8YA475ME21#	Derating		
	25Vdc	X7S	4.7μF	±10%	GRM219C71E475KE21#	Derating		
				±20%	GRM219C71E475ME21#	Derating		
		X6S	4.7μF	±10%	GRM219C81E475KE21#	Derating		
				±20%	GRM219C81E475ME21#	Derating		
	16Vdc	X7S	4.7μF	±10%	GRM219C71C475KE21#			
				±20%	GRM219C71C475ME21#			
	1.35mm	100Vdc	X7R	22μF	±20%	GRM219R61C226ME15#	Derating	
1.35mm	100Vdc	X7R	10000pF	±10%	GRM21BR72A103KA01#			
			15000pF	±10%	GRM21BR72A153KA01#			
			22000pF	±10%	GRM21BR72A223KA01#			
			33000pF	±10%	GRM21BR72A333KA01#			
			47000pF	±10%	GRM21BR72A473KA01#			
			68000pF	±10%	GRM21BR72A683KAC4#			
				±20%	GRM21BR72A683MAC4#			
			0.10μF	±10%	GRM21BR72A104KAC4#			
				±20%	GRM21BR72A104MAC4#			
			50Vdc	R	0.10μF	±10%	GRM21BR11H104KA01#	
						±20%	GRM21BR11H104MA01#	
				X7R	47000pF	±10%	GRM21BR71H473KA01#	
	68000pF	±10%			GRM21BR71H683KA01#			
	0.10μF	±10%			GRM21BR71H104KA01#			
		±20%			GRM21BR71H104MA01#			
	0.15μF	±10%	GRM21BR71H154KA01#					
		±20%	GRM21BR71H154MA01#					
	B	0.15μF	±10%	GRM21BB31H154KA88#				
			±20%	GRM21BB31H154MA88#				
		0.22μF	±10%	GRM21BB31H224KA88#				
			±20%	GRM21BB31H224MA88#				
		0.47μF	±10%	GRM21BB31H474KA87#				
			±20%	GRM21BB31H474MA87#				
	0.68μF	±10%	GRM21BB31H684KAC4#					
		±20%	GRM21BB31H684MAC4#					
	25Vdc	R	0.15μF	±10%	GRM21BR11E154KA01#			
				±20%	GRM21BR11E154MA01#			
		X7R	47000pF	±10%	GRM21BR71C473KA01#			
				±20%	GRM21BR71C473MA01#			
		0.10μF	±10%	GRM21BR71H104KA01#				
			±20%	GRM21BR71H104MA01#				
	0.15μF	±10%	GRM21BR71H154KA01#					
		±20%	GRM21BR71H154MA01#					

T寸法 最大値	定格 電圧	温度 特性	静電容量	許容差	品番		
1.35mm	25Vdc	R	0.15μF	±20%	GRM21BR11E154MA01#		
		X6S	4.7μF	±10%	GRM21BC81E475KA12#		
				±20%	GRM21BC81E475MA12#		
		B	2.2μF	±10%	GRM21BB31E225KA75#		
				±20%	GRM21BB31E225MA75#		
		4.7μF	±10%	GRM21BB31E475KA75#			
			±20%	GRM21BB31E475MA75#			
		X5R	4.7μF	±10%	GRM21BR61E475KA12#		
				±20%	GRM21BR61E475MA12#		
		16Vdc	X7R	2.2μF	±10%	GRM21BR71C225KA12#	
					±20%	GRM21BR71C225MA12#	
	B		10μF	±10%	GRM21BB31C106KE15#		
				±20%	GRM21BB31C106ME15#		
	X5R		10μF	±10%	GRM21BR61C106KE15#		
				±20%	GRM21BR61C106ME15#		
	1.4mm	100Vdc	X7R	0.47μF	±10%	GRM21BR72A474KA73#	
50Vdc		B	2.2μF	±10%	GRM21BB31H225KA73#		
				±20%	GRM21BB31H225MA73#		
				4.7μF	±10%	GRM21BB31H475KE51#	
	±20%	GRM21BB31H475ME51#					
	X5R	2.2μF	±10%		GRM21BR61H225KA73#		
			±20%	GRM21BR61H225MA73#			
4.7μF			±10%	GRM21BR61H475KE51#			
	±20%	GRM21BR61H475ME51#					
	25Vdc	R	1.0μF	±10%	GRM21BR11E105KA99#		
X7R		1.0μF	±10%	GRM21BR71E105KA99#			
			±20%	GRM21BR71E225KE11#			
2.2μF		±10%	GRM21BR71E225ME11#				
		±20%	GRM21BR71E225ME11#				
4.7μF		±10%	GRM21BR71E475KA73#	Derating			
		±20%	GRM21BR71E475MA73#	Derating			
B		10μF	±10%	GRM21BB31E106KA73#			
			±20%	GRM21BB31E106MA73#			
X5R		10μF	±10%	GRM21BR61E106KA73#			
			±20%	GRM21BR61E106MA73#			
16Vdc	X7R	4.7μF	±10%	GRM21BR71C475KA73#			
			±20%	GRM21BR71C475MA73#			
	X6S	10μF	±10%	GRM21BC81C106KA73#			
			±20%	GRM21BC81C106MA73#			
	10Vdc	X7R	4.7μF	±10%	GRM21BR71A475KA73#		
				±20%	GRM21BR71A475MA73#		
10μF	±10%	GRM21BR71A106KE51#					
	±20%	GRM21BR71A106ME51#	Derating				
6.3Vdc	X7R	10μF	±10%	GRM21BR70J106KE76#			
			±20%	GRM21BR70J106ME76#			
X6S	22μF	±20%	GRM21BC80J226ME51#	Derating			
4Vdc	X7U	22μF	±20%	GRM21BE70G226ME51#			
X6S	22μF	±20%	GRM21BC80G226ME39#				
1.45mm	250Vdc	X7R	10000pF	±10%	GRM21BR72E103KW03#		
			15000pF	±10%	GRM21BR72E153KW03#		
			22000pF	±10%	GRM21BR72E223KW03#		
	200Vdc	X7R	10000pF	±10%	GRM21BR72D103KW03#		
			15000pF	±10%	GRM21BR72D153KW03#		
			22000pF	±10%	GRM21BR72D223KW03#		

品番 #には包装仕様コードが入ります。

GRMシリーズ 高誘電率系 品番表

(→ ■2.0×1.25mm)

T寸法 最大値	定格 電圧	温度 特性	静電容量	許容差	品番	
1.45mm	50Vdc	X7S	4.7μF	±10%	GRM21BC71H475KE11#	
				±20%	GRM21BC71H475ME11#	
				±10%	GRM21BC81H475KE11#	
		X6S	4.7μF	±10%	GRM21BC81H475ME11#	
				±20%	GRM21BC81H475ME11#	
				±10%	GRM21BC7YA475KE11#	
	35Vdc	X7S	4.7μF	±10%	GRM21BC7YA475KE11#	
				±20%	GRM21BC7YA475ME11#	
				±10%	GRM21BC8YA106KE11#	Derating
		X6S	10μF	±10%	GRM21BC8YA106ME11#	Derating
				±20%	GRM21BC8YA106ME11#	Derating
				±10%	GRM21BR6YA106KE43#	Derating
	X5R	10μF	±10%	GRM21BR6YA106ME43#	Derating	
			±20%	GRM21BR6YA106ME43#	Derating	
			±10%	GRM21BC71E475KE11#		
	25Vdc	X7S	4.7μF	±10%	GRM21BC71E475KE11#	
				±20%	GRM21BC71E475ME11#	
				±10%	GRM21BC71E106KE11#	Derating
		X6S	10μF	±10%	GRM21BC71E106ME11#	Derating
				±20%	GRM21BC71E106ME11#	Derating
				±10%	GRM21BC81E106KE11#	Derating
	X5R	22μF	±10%	GRM21BC81E106ME11#	Derating	
			±20%	GRM21BC81E106ME11#	Derating	
			±20%	GRM21BR61E226ME44#		
16Vdc	X7S	10μF	±10%	GRM21BC71C106KE11#		
			±20%	GRM21BC71C106ME11#		
			±20%	GRM21BC81C226ME44#	Derating	
	X6S	22μF	±10%	GRM21BC81C226ME44#	Derating	
			±20%	GRM21BC81C226ME44#	Derating	
			±20%	GRM21BR61C226ME44#		
10Vdc	X7T	22μF	±20%	GRM21BD71A226ME44#	Derating	
			±20%	GRM21BC81A226ME44#		
			±20%	GRM21BR61A226ME44#		
	X6S	22μF	±20%	GRM21BC81A226ME44#		
			±20%	GRM21BR61A476ME15#	Derating	
			±20%	GRM21BD70J226ME44#		
6.3Vdc	X7T	22μF	±20%	GRM21BD70J226ME44#		
			±20%	GRM21BB30J476ME15#	Derating	
			±20%	GRM21BR60J476ME15#	Derating	
	B	47μF	±20%	GRM21BB30J476ME15#	Derating	
			±20%	GRM21BR60J476ME15#	Derating	
			±20%	GRM21BC80G476ME15#	Derating	
X5R	47μF	±20%	GRM21BC80G476ME15#	Derating		
		±20%	GRM21BB30G476ME15#			
		±20%	GRM21BR60G476ME15#			

■3.2×1.6mm

T寸法 最大値	定格 電圧	温度 特性	静電容量	許容差	品番	
0.95mm	35Vdc	X5R	10μF	±10%	GRM319R6YA106KA12#	Derating
				±20%	GRM319R6YA106MA12#	Derating
				±10%	GRM319R11E334KA01#	
		R	0.33μF	±10%	GRM319R11E334KA01#	
				±20%	GRM319B31C106KE15#	
				±20%	GRM319B31C106ME15#	
	16Vdc	B	10μF	±10%	GRM319B31C106KE15#	
				±20%	GRM319B31C106ME15#	
				±20%	GRM319B31C226ME15#	Derating
		X5R	10μF	±10%	GRM319R61C106KE15#	
				±20%	GRM319R61C106ME15#	
				±20%	GRM319R61C226ME15#	Derating
	10Vdc	B	22μF	±20%	GRM319B31A226ME15#	
				±20%	GRM319R61A226ME15#	
				±20%	GRM319C80J226ME15#	
		X5R	22μF	±20%	GRM319R61A226ME15#	
				±20%	GRM319C80J226ME15#	
				±20%	GRM319B30J226ME15#	
6.3Vdc	X6S	22μF	±20%	GRM319C80J226ME15#		
			±20%	GRM319B30J226ME15#		
			±20%	GRM319R60J226ME15#		
	B	22μF	±20%	GRM319B30J226ME15#		
			±20%	GRM319R60J226ME15#		
			±20%	GRM319R60J226ME15#		
1.0mm	630Vdc	X7R	1000pF	±10%	GRM31AR72J102KW01#	
				±10%	GRM31AR72J152KW01#	
				±10%	GRM31AR72J222KW01#	
				±10%	GRM31AR72J332KW01#	
				±10%	GRM31AR72J102KW01#	
				±10%	GRM31AR72J152KW01#	

T寸法 最大値	定格 電圧	温度 特性	静電容量	許容差	品番		
1.0mm	630Vdc	X7R	4700pF	±10%	GRM31AR72J472KW01#		
				±10%	GRM31AR72J682KW01#		
				±10%	GRM31AR72J103KW01#		
1.25mm	1000Vdc	X7R	470pF	±10%	GRM31BR73A471KW01#		
				±10%	GRM31BR73A681KW01#		
				±10%	GRM31BR73A102KW01#		
				±10%	GRM31BR73A152KW01#		
				±10%	GRM31BR73A222KW01#		
				±10%	GRM31BR73A332KW01#		
				±10%	GRM31BR73A472KW01#		
				±10%	GRM31BR72J682KW01#		
				±10%	GRM31BR72E153KW01#		
	630Vdc	X7R	6800pF	±10%	GRM31BR72E153KW01#		
				±10%	GRM31BR72E223KW01#		
				±10%	GRM31BR72E683KW01#		
	250Vdc	X7R	15000pF	±10%	GRM31BR72E153KW01#		
				±10%	GRM31BR72E223KW01#		
				±10%	GRM31BR72E683KW01#		
	200Vdc	X7R	15000pF	±10%	GRM31BR72D153KW01#		
				±10%	GRM31BR72D223KW01#		
				±10%	GRM31BR72D683KW01#		
50Vdc	X7R	0.47μF	±10%	GRM31MR71H474KA01#			
			±10%	GRM31MR71H684KA88#			
			±10%	GRM31MR71H105KA88#			
	B	1.0μF	±10%	GRM31MR71H105KA88#			
			±10%	GRM31MR71H105KA87#			
			±20%	GRM31MR61E106MA12#			
1.3mm	100Vdc	X7R	0.47μF	±10%	GRM31MR72A474KA35#		
				±20%	GRM31MR72A474MA35#		
				±10%	GRM31MR72A684KA35#		
	1.8mm	1000Vdc	X7R	6800pF	±10%	GRM31CR73A682KW03#	
					±10%	GRM31CR73A103KW03#	
					±10%	GRM31CR72J153KW03#	
630Vdc	X7R	15000pF	±10%	GRM31CR72J153KW03#			
			±10%	GRM31CR72J223KW03#			
			±10%	GRM31CR72E333KW03#			
250Vdc	X7R	33000pF	±10%	GRM31CR72E333KW03#			
			±10%	GRM31CR72E473KW03#			
			±10%	GRM31CR72E104KW03#			
200Vdc	X7R	33000pF	±10%	GRM31CR72D333KW03#			
			±10%	GRM31CR72D473KW03#			
			±10%	GRM31CR72D104KW03#			
100Vdc	X7R	1.0μF	±10%	GRM31CR72A105KA01#			
			±10%	GRM31CR71H225KA88#			
			±10%	GRM31CR71H475KA12#			
	B	2.2μF	±10%	GRM31CB31H225KA87#			
			±20%	GRM31CB31H225MA87#			
			±10%	GRM31CB31H475KA12#			
X5R	10μF	±10%	GRM31CB31H475MA12#				
		±20%	GRM31CB31H106KA12#				
		±20%	GRM31CB31H106MA12#				
25Vdc	X7R	4.7μF	±10%	GRM31CR71E475KA88#			
			±10%	GRM31CR71E106KA12#			
			±20%	GRM31CR71E106MA12#			
	B	10μF	±10%	GRM31CB31E106KA75#			
			±20%	GRM31CB31E226ME15#			
			±20%	GRM31CR61E226ME15#			
16Vdc	X7R	4.7μF	±20%	GRM31CR71C475MA01#			

品番 #には包装仕様コードが入ります。

GRMシリーズ
 GJMシリーズ
 GMAシリーズ
 GMDシリーズ
 GQMシリーズ
 GRJシリーズ
 GR3シリーズ
 KRMシリーズ
 KR3シリーズ
 LLAシリーズ
 LLLシリーズ
 LLMシリーズ
 LLRシリーズ
 △注意/
 使用上の注意

△お願い ・製品によっては、お守りいただかないと発煙、発火等にいたる可能性のある定格や△注意（保管・使用環境、定格上の注意、実装上の注意、取扱上の注意）を記載しておりますので、必ずご覧下さい。
 ・当カタログには、代表的な仕様しか記載しておりませんので、ご注文にあたっては詳細な仕様記載されている納入仕様書の内容をご確認いただくか承認図の取交しをお願いします。

GRMシリーズ 高誘電率系 品番表

(→ ■3.2×1.6mm)

T寸法 最大値	定格 電圧	温度 特性	静電容量	許容差	品番	
1.8mm	16Vdc	X6S	22μF	±20%	GRM31CC81C226ME15#	
		B	22μF	±20%	GRM31CB31C226ME15#	
		X5R	22μF	±20%	GRM31CR61C226ME15#	
	10Vdc	X7R	22μF	±20%	GRM31CR71A226ME15#	
		B	47μF	±20%	GRM31CB31A476ME15#	
		X5R	47μF	±20%	GRM31CR61A476ME15#	
	6.3Vdc	X7R	22μF	±20%	GRM31CR70J226ME19#	
		X7U	47μF	±20%	GRM31CE70J476ME15#	Derating
		X6S	47μF	±20%	GRM31CC80J476ME18#	
		B	47μF	±20%	GRM31CB30J476ME18#	
		X5R	47μF	±20%	GRM31CR60J476ME19#	
	4Vdc	X7U	47μF	±20%	GRM31CE70G476ME15#	
		X6S	47μF	±20%	GRM31CC80G476ME19#	
	1.9mm	100Vdc	X7R	2.2μF	±10%	GRM31CR72A225KA73#
±20%				GRM31CR72A225MA73#		
25Vdc		X6S	22μF	±20%	GRM31CC81E226ME11#	
16Vdc		X7S	22μF	±20%	GRM31CC71C226ME11#	
6.3Vdc		X6T	100μF	±20%	GRM31CD80J107ME39#	Derating
			X5R	100μF	±20%	GRM31CR60J107ME39#
4Vdc		X7U	100μF	±20%	GRM31CE70G107ME39#	Derating
			X6T	100μF	±20%	GRM31CD80G107ME39#
		X5R	100μF	±20%	GRM31CR60G107ME39#	
			220μF	±20%	GRM31CR60G227ME11#	Derating

■3.2×2.5mm

T寸法 最大値	定格 電圧	温度 特性	静電容量	許容差	品番	
1.5mm	1000Vdc	X7R	6800pF	±10%	GRM32QR73A682KW01#	
			10000pF	±10%	GRM32QR73A103KW01#	
	630Vdc	X7R	22000pF	±10%	GRM32QR72J223KW01#	
	250Vdc	X7R	68000pF	±10%	GRM32QR72E683KW01#	
			0.15μF	±10%	GRM32QR72E154KW01#	
200Vdc	X7R	68000pF	±10%	GRM32QR72D683KW01#		
		0.15μF	±10%	GRM32QR72D154KW01#		
1.8mm	100Vdc	X7R	1.0μF	±10%	GRM32CR72A105KA35#	
				±20%	GRM32CR72A105MA35#	
2.0mm	1000Vdc	X7R	15000pF	±10%	GRM32DR73A153KW01#	
			22000pF	±10%	GRM32DR73A223KW01#	
	630Vdc	X7R	33000pF	±10%	GRM32DR72J333KW01#	
			47000pF	±10%	GRM32DR72J473KW01#	
	250Vdc	X7R	0.10μF	±10%	GRM32DR72E104KW01#	
			0.22μF	±10%	GRM32DR72E224KW01#	
	200Vdc	X7R	0.10μF	±10%	GRM32DR72D104KW01#	
			0.22μF	±10%	GRM32DR72D224KW01#	
2.2mm	25Vdc	X7R	10μF	±10%	GRM32DR71E106KA12#	
2.7mm	100Vdc	X7R	2.2μF	±10%	GRM32ER72A225KA35#	
			±20%	GRM32ER72A225MA35#		
	80Vdc	X7R	4.7μF	±10%	GRM32ER71K475KE14#	Derating
			±20%	GRM32ER71K475ME14#	Derating	
	63Vdc	X7R	10μF	±10%	GRM32ER71J106KA12#	Derating
			±20%	GRM32ER71J106MA12#	Derating	
50Vdc	X7R	4.7μF	±10%	GRM32ER71H475KA88#		
		10μF	±10%	GRM32ER71H106KA12#		

T寸法 最大値	定格 電圧	温度 特性	静電容量	許容差	品番		
2.7mm	50Vdc	X7R	10μF	±20%	GRM32ER71H106MA12#		
			B	10μF	±10%	GRM32EB31H106KA12#	
					±20%	GRM32EB31H106MA12#	
		X5R	10μF	±10%	GRM32ER61H106KA12#		
				±20%	GRM32ER61H106MA12#		
		35Vdc	X7R	10μF	±10%	GRM32ER7YA106KA12#	
	±20%			GRM32ER7YA106MA12#			
	B		10μF	±10%	GRM32EB3YA106KA12#		
				±20%	GRM32EB3YA106MA12#		
	X5R		10μF	±10%	GRM32ER6YA106KA12#		
				±20%	GRM32ER6YA106MA12#		
	25Vdc	X7R	22μF	±20%	GRM32ER71E226ME15#		
			B	22μF	±20%	GRM32EB31E226ME15#	
		X5R	22μF	±20%	GRM32ER61E226ME15#		
	16Vdc	X7R	22μF	±20%	GRM32ER71C226MEA8#		
			X6S	47μF	±20%	GRM32EC81C476ME15#	Derating
		B	47μF	±20%	GRM32EB31C476ME15#		
				X5R	47μF	±20%	GRM32ER61C476ME15#
10Vdc		X7R	47μF	±20%	GRM32ER71A476ME15#		
	B		47μF	±20%	GRM32EB31A476ME20#		
	X5R	47μF	±20%	GRM32ER61A476ME20#			
			100μF	±20%	GRM32ER61A107ME20#	Derating	
6.3Vdc	X7R	47μF	±20%	GRM32ER70J476ME20#			
		X7U	100μF	±20%	GRM32EE70J107ME15#	Derating	
	B	100μF	±20%	GRM32EB30J107ME16#			
X5R	100μF	±20%	GRM32ER60J107ME20#				
4Vdc	X7U	100μF	±20%	GRM32EE70G107ME19#			

■4.5×3.2mm

T寸法 最大値	定格 電圧	温度 特性	静電容量	許容差	品番	
1.5mm	630Vdc	X7R	68000pF	±10%	GRM43QR72J683KW01#	
	250Vdc	X7R	0.15μF	±10%	GRM43QR72E154KW01#	
	200Vdc	X7R	0.15μF	±10%	GRM43QR72D154KW01#	
2.0mm	1000Vdc	X7R	33000pF	±10%	GRM43DR73A333KW01#	
			47000pF	±10%	GRM43DR73A473KW01#	
	630Vdc	X7R	0.10μF	±10%	GRM43DR72J104KW01#	
			0.22μF	±10%	GRM43DR72E224KW01#	
	250Vdc	X7R	0.33μF	±10%	GRM43DR72E334KW01#	
			0.47μF	±10%	GRM43DR72E474KW01#	
			0.22μF	±10%	GRM43DR72D224KW01#	
	200Vdc	X7R	0.33μF	±10%	GRM43DR72D334KW01#	
0.47μF			±10%	GRM43DR72D474KW01#		

■5.7×5.0mm

T寸法 最大値	定格 電圧	温度 特性	静電容量	許容差	品番	
2.0mm	1000Vdc	X7R	68000pF	±10%	GRM55DR73A683KW01#	
			0.10μF	±10%	GRM55DR73A104KW01#	
	630Vdc	X7R	0.15μF	±10%	GRM55DR72J154KW01#	
			0.22μF	±10%	GRM55DR72J224KW01#	
	250Vdc	X7R	0.33μF	±10%	GRM55DR72E334KW01#	

品番 #には包装仕様コードが入ります。

GRMシリーズ 高誘電率系 品番表

(→ ■5.7×5.0mm)

T寸法 最大値	定格 電圧	温度 特性	静電容量	許容差	品番
2.0mm	250Vdc	X7R	0.47μF	±10%	GRM55DR72E474KW01#
			0.68μF	±10%	GRM55DR72E684KW01#
			1.0μF	±10%	GRM55DR72E105KW01#
	200Vdc	X7R	0.33μF	±10%	GRM55DR72D334KW01#
			0.47μF	±10%	GRM55DR72D474KW01#
			0.68μF	±10%	GRM55DR72D684KW01#
			1.0μF	±10%	GRM55DR72D105KW01#

GRMシリーズ

GJMシリーズ

GMAシリーズ

GMDシリーズ

GQMシリーズ

GRJシリーズ

GR3シリーズ

KRMシリーズ

KR3シリーズ

LLAシリーズ

LLLシリーズ

LLMシリーズ

LLRシリーズ

△注意/
使用上の注意

高周波用High Q品 1005(in mm)サイズ以下

GJMシリーズ High Q

High Q・低ESRにより、高周波特性の向上、低消費電力化に貢献します。

特徴

① 主に移動体通信機器および関連モジュール温度補償用として最適。

共振回路や同調回路、インピーダンスマッチング回路といった、容量変動が機器の動作特性に大きく影響する高周波回路の温度補償用に最適です。

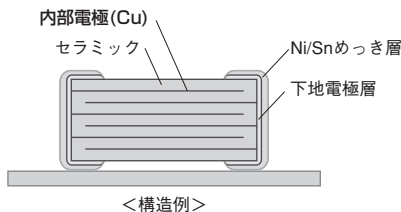

② VHF、UHF、マイクロ波の周波数帯で、High Q、低ESR。

誘電体材料に高周波での損失が非常に小さいセラミック材料、内部電極に銅を採用することにより、高周波でHigh Q、低ESRを実現しました。

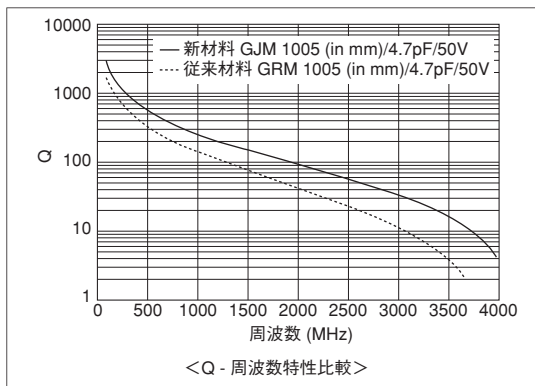
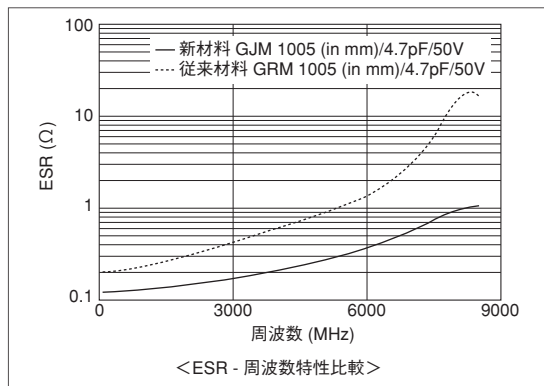

③ 狭静電容量許容差に対応。

標準静電容量許容差以外にも静電容量範囲により以下の狭静電容量許容差に対応しています。

静電容量範囲	標準静電容量許容差（静電容量許容差記号）	狭静電容量許容差（静電容量許容差記号）
~0.9pF	±0.1pF (B)	±0.05pF (W)
1.0~5.0pF	±0.25pF (C)	±0.05pF (W)、±0.1pF (B)
5.1~9.9pF	±0.5pF (D)	±0.05pF (W)、±0.1pF (B)、±0.25pF (C)
10pF~	±5% (J)	±2% (G)

主な仕様

サイズ	0.4×0.2mm~1.0×0.5mm
定格電圧	DC6.3V~50V
静電容量	0.1pF~47pF
主な用途	携帯電話等の小型通信機器、高周波通信モジュール

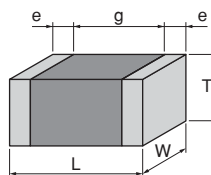

<外形寸法図>

当カタログに掲載している製品は一部です。
 詳しくはWebサイトのコンデンサ検索ページをご参照ください。

GRMシリーズ
 GJMシリーズ
 GMAシリーズ
 GMDシリーズ
 GQMシリーズ
 GRUシリーズ
 GR3シリーズ
 KRMシリーズ
 KR3シリーズ
 LLAシリーズ
 LLLシリーズ
 LLMシリーズ
 LLRシリーズ
 △注意/使用上の注意

GJMシリーズ 温度補償用 High Q 品番表

0.4×0.2mm 超小型

T寸法 最大値	定格 電圧	温度 特性	静電容量	許容差	品番
0.22mm	25Vdc	CK	0.20pF	±0.05pF	GJM0224C1ER20WB01#
				±0.1pF	GJM0224C1ER20BB01#
			0.30pF	±0.05pF	GJM0224C1ER30WB01#
				±0.1pF	GJM0224C1ER30BB01#
			0.40pF	±0.05pF	GJM0224C1ER40WB01#
				±0.1pF	GJM0224C1ER40BB01#
			0.50pF	±0.05pF	GJM0224C1ER50WB01#
				±0.1pF	GJM0224C1ER50BB01#
			0.60pF	±0.05pF	GJM0224C1ER60WB01#
				±0.1pF	GJM0224C1ER60BB01#
			0.70pF	±0.05pF	GJM0224C1ER70WB01#
				±0.1pF	GJM0224C1ER70BB01#
			0.80pF	±0.05pF	GJM0224C1ER80WB01#
				±0.1pF	GJM0224C1ER80BB01#
			0.90pF	±0.05pF	GJM0224C1ER90WB01#
				±0.1pF	GJM0224C1ER90BB01#
			1.0pF	±0.05pF	GJM0224C1E1R0WB01#
				±0.1pF	GJM0224C1E1R0BB01#
				±0.25pF	GJM0224C1E1R0CB01#
			1.1pF	±0.05pF	GJM0224C1E1R1WB01#
				±0.1pF	GJM0224C1E1R1BB01#
				±0.25pF	GJM0224C1E1R1CB01#
			1.2pF	±0.05pF	GJM0224C1E1R2WB01#
				±0.1pF	GJM0224C1E1R2BB01#
		±0.25pF		GJM0224C1E1R2CB01#	
		1.3pF	±0.05pF	GJM0224C1E1R3WB01#	
			±0.1pF	GJM0224C1E1R3BB01#	
			±0.25pF	GJM0224C1E1R3CB01#	
		1.4pF	±0.05pF	GJM0224C1E1R4WB01#	
			±0.1pF	GJM0224C1E1R4BB01#	
			±0.25pF	GJM0224C1E1R4CB01#	
		1.5pF	±0.05pF	GJM0224C1E1R5WB01#	
			±0.1pF	GJM0224C1E1R5BB01#	
			±0.25pF	GJM0224C1E1R5CB01#	
		1.6pF	±0.05pF	GJM0224C1E1R6WB01#	
			±0.1pF	GJM0224C1E1R6BB01#	
			±0.25pF	GJM0224C1E1R6CB01#	
		1.7pF	±0.05pF	GJM0224C1E1R7WB01#	
			±0.1pF	GJM0224C1E1R7BB01#	
			±0.25pF	GJM0224C1E1R7CB01#	
		1.8pF	±0.05pF	GJM0224C1E1R8WB01#	
			±0.1pF	GJM0224C1E1R8BB01#	
			±0.25pF	GJM0224C1E1R8CB01#	
		1.9pF	±0.05pF	GJM0224C1E1R9WB01#	
			±0.1pF	GJM0224C1E1R9BB01#	
			±0.25pF	GJM0224C1E1R9CB01#	
		2.0pF	±0.05pF	GJM0224C1E2R0WB01#	
			±0.1pF	GJM0224C1E2R0BB01#	
±0.25pF	GJM0224C1E2R0CB01#				
CJ	2.1pF	±0.05pF	GJM0223C1E2R1WB01#		
		±0.1pF	GJM0223C1E2R1BB01#		
		±0.25pF	GJM0223C1E2R1CB01#		

T寸法 最大値	定格 電圧	温度 特性	静電容量	許容差	品番
0.22mm	25Vdc	CJ	2.2pF	±0.05pF	GJM0223C1E2R2WB01#
				±0.1pF	GJM0223C1E2R2BB01#
				±0.25pF	GJM0223C1E2R2CB01#
			2.3pF	±0.05pF	GJM0223C1E2R3WB01#
				±0.1pF	GJM0223C1E2R3BB01#
				±0.25pF	GJM0223C1E2R3CB01#
			2.4pF	±0.05pF	GJM0223C1E2R4WB01#
				±0.1pF	GJM0223C1E2R4BB01#
				±0.25pF	GJM0223C1E2R4CB01#
			2.5pF	±0.05pF	GJM0223C1E2R5WB01#
				±0.1pF	GJM0223C1E2R5BB01#
				±0.25pF	GJM0223C1E2R5CB01#
			2.6pF	±0.05pF	GJM0223C1E2R6WB01#
				±0.1pF	GJM0223C1E2R6BB01#
				±0.25pF	GJM0223C1E2R6CB01#
			2.7pF	±0.05pF	GJM0223C1E2R7WB01#
				±0.1pF	GJM0223C1E2R7BB01#
				±0.25pF	GJM0223C1E2R7CB01#
			2.8pF	±0.05pF	GJM0223C1E2R8WB01#
				±0.1pF	GJM0223C1E2R8BB01#
				±0.25pF	GJM0223C1E2R8CB01#
			2.9pF	±0.05pF	GJM0223C1E2R9WB01#
				±0.1pF	GJM0223C1E2R9BB01#
				±0.25pF	GJM0223C1E2R9CB01#
			3.0pF	±0.05pF	GJM0223C1E3R0WB01#
				±0.1pF	GJM0223C1E3R0BB01#
				±0.25pF	GJM0223C1E3R0CB01#
			3.1pF	±0.05pF	GJM0223C1E3R1WB01#
				±0.1pF	GJM0223C1E3R1BB01#
				±0.25pF	GJM0223C1E3R1CB01#
			3.2pF	±0.05pF	GJM0223C1E3R2WB01#
				±0.1pF	GJM0223C1E3R2BB01#
				±0.25pF	GJM0223C1E3R2CB01#
			3.3pF	±0.05pF	GJM0223C1E3R3WB01#
				±0.1pF	GJM0223C1E3R3BB01#
				±0.25pF	GJM0223C1E3R3CB01#
			3.4pF	±0.05pF	GJM0223C1E3R4WB01#
				±0.1pF	GJM0223C1E3R4BB01#
				±0.25pF	GJM0223C1E3R4CB01#
			3.5pF	±0.05pF	GJM0223C1E3R5WB01#
				±0.1pF	GJM0223C1E3R5BB01#
				±0.25pF	GJM0223C1E3R5CB01#
			3.6pF	±0.05pF	GJM0223C1E3R6WB01#
				±0.1pF	GJM0223C1E3R6BB01#
				±0.25pF	GJM0223C1E3R6CB01#
			3.7pF	±0.05pF	GJM0223C1E3R7WB01#
				±0.1pF	GJM0223C1E3R7BB01#
				±0.25pF	GJM0223C1E3R7CB01#
3.8pF	±0.05pF	GJM0223C1E3R8WB01#			
	±0.1pF	GJM0223C1E3R8BB01#			
	±0.25pF	GJM0223C1E3R8CB01#			
3.9pF	±0.05pF	GJM0223C1E3R9WB01#			
	±0.1pF	GJM0223C1E3R9BB01#			
	±0.25pF	GJM0223C1E3R9CB01#			

品番 #には包装仕様コードが入ります。

GRMシリーズ
 GJMシリーズ
 GMAシリーズ
 GMDシリーズ
 GQMシリーズ
 GRUシリーズ
 GR3シリーズ
 KRMシリーズ
 KR3シリーズ
 LLAシリーズ
 LLLシリーズ
 LLMシリーズ
 LLRシリーズ
 △注意/
 使用上の注意

GJMシリーズ 温度補償用 High Q 品番表

(→ ■0.4×0.2mm)

T寸法 最大値	定格 電圧	温度 特性	静電容量	許容差	品番
0.22mm	25Vdc	CH	4.0pF	±0.05pF	GJM0222C1E4R0WB01#
				±0.1pF	GJM0222C1E4R0BB01#
				±0.25pF	GJM0222C1E4R0CB01#
			4.1pF	±0.05pF	GJM0222C1E4R1WB01#
				±0.1pF	GJM0222C1E4R1BB01#
				±0.25pF	GJM0222C1E4R1CB01#
			4.2pF	±0.05pF	GJM0222C1E4R2WB01#
				±0.1pF	GJM0222C1E4R2BB01#
				±0.25pF	GJM0222C1E4R2CB01#
			4.3pF	±0.05pF	GJM0222C1E4R3WB01#
				±0.1pF	GJM0222C1E4R3BB01#
				±0.25pF	GJM0222C1E4R3CB01#
			4.4pF	±0.05pF	GJM0222C1E4R4WB01#
				±0.1pF	GJM0222C1E4R4BB01#
				±0.25pF	GJM0222C1E4R4CB01#
			4.5pF	±0.05pF	GJM0222C1E4R5WB01#
				±0.1pF	GJM0222C1E4R5BB01#
				±0.25pF	GJM0222C1E4R5CB01#
			4.6pF	±0.05pF	GJM0222C1E4R6WB01#
				±0.1pF	GJM0222C1E4R6BB01#
				±0.25pF	GJM0222C1E4R6CB01#
			4.7pF	±0.05pF	GJM0222C1E4R7WB01#
				±0.1pF	GJM0222C1E4R7BB01#
				±0.25pF	GJM0222C1E4R7CB01#
			4.8pF	±0.05pF	GJM0222C1E4R8WB01#
				±0.1pF	GJM0222C1E4R8BB01#
				±0.25pF	GJM0222C1E4R8CB01#
			4.9pF	±0.05pF	GJM0222C1E4R9WB01#
				±0.1pF	GJM0222C1E4R9BB01#
				±0.25pF	GJM0222C1E4R9CB01#
			5.0pF	±0.05pF	GJM0222C1E5R0WB01#
				±0.1pF	GJM0222C1E5R0BB01#
				±0.25pF	GJM0222C1E5R0CB01#
			5.1pF	±0.05pF	GJM0222C1E5R1WB01#
				±0.1pF	GJM0222C1E5R1BB01#
				±0.25pF	GJM0222C1E5R1CB01#
				±0.5pF	GJM0222C1E5R1DB01#
			5.2pF	±0.05pF	GJM0222C1E5R2WB01#
				±0.1pF	GJM0222C1E5R2BB01#
				±0.25pF	GJM0222C1E5R2CB01#
				±0.5pF	GJM0222C1E5R2DB01#
			5.3pF	±0.05pF	GJM0222C1E5R3WB01#
				±0.1pF	GJM0222C1E5R3BB01#
				±0.25pF	GJM0222C1E5R3CB01#
				±0.5pF	GJM0222C1E5R3DB01#
			5.4pF	±0.05pF	GJM0222C1E5R4WB01#
				±0.1pF	GJM0222C1E5R4BB01#
				±0.25pF	GJM0222C1E5R4CB01#
±0.5pF	GJM0222C1E5R4DB01#				
5.5pF	±0.05pF	GJM0222C1E5R5WB01#			
	±0.1pF	GJM0222C1E5R5BB01#			
	±0.25pF	GJM0222C1E5R5CB01#			
	±0.5pF	GJM0222C1E5R5DB01#			
5.6pF	±0.05pF	GJM0222C1E5R6WB01#			

T寸法 最大値	定格 電圧	温度 特性	静電容量	許容差	品番
0.22mm	25Vdc	CH	5.6pF	±0.1pF	GJM0222C1E5R6BB01#
				±0.25pF	GJM0222C1E5R6CB01#
				±0.5pF	GJM0222C1E5R6DB01#
			5.7pF	±0.05pF	GJM0222C1E5R7WB01#
				±0.1pF	GJM0222C1E5R7BB01#
				±0.25pF	GJM0222C1E5R7CB01#
			5.8pF	±0.05pF	GJM0222C1E5R8WB01#
				±0.1pF	GJM0222C1E5R8BB01#
				±0.25pF	GJM0222C1E5R8CB01#
			5.9pF	±0.05pF	GJM0222C1E5R9WB01#
				±0.1pF	GJM0222C1E5R9BB01#
				±0.25pF	GJM0222C1E5R9CB01#
			6.0pF	±0.05pF	GJM0222C1E6R0WB01#
				±0.1pF	GJM0222C1E6R0BB01#
				±0.25pF	GJM0222C1E6R0CB01#
			6.1pF	±0.05pF	GJM0222C1E6R1WB01#
				±0.1pF	GJM0222C1E6R1BB01#
				±0.25pF	GJM0222C1E6R1CB01#
			6.2pF	±0.05pF	GJM0222C1E6R2WB01#
				±0.1pF	GJM0222C1E6R2BB01#
				±0.25pF	GJM0222C1E6R2CB01#
			6.3pF	±0.05pF	GJM0222C1E6R3WB01#
				±0.1pF	GJM0222C1E6R3BB01#
				±0.25pF	GJM0222C1E6R3CB01#
			6.4pF	±0.05pF	GJM0222C1E6R4WB01#
				±0.1pF	GJM0222C1E6R4BB01#
				±0.25pF	GJM0222C1E6R4CB01#
			6.5pF	±0.05pF	GJM0222C1E6R5WB01#
				±0.1pF	GJM0222C1E6R5BB01#
				±0.25pF	GJM0222C1E6R5CB01#
			6.6pF	±0.05pF	GJM0222C1E6R6WB01#
				±0.1pF	GJM0222C1E6R6BB01#
				±0.25pF	GJM0222C1E6R6CB01#
			6.7pF	±0.05pF	GJM0222C1E6R7WB01#
				±0.1pF	GJM0222C1E6R7BB01#
				±0.25pF	GJM0222C1E6R7CB01#
			6.8pF	±0.05pF	GJM0222C1E6R8WB01#
				±0.1pF	GJM0222C1E6R8BB01#
				±0.25pF	GJM0222C1E6R8CB01#
			6.9pF	±0.05pF	GJM0222C1E6R9WB01#
				±0.1pF	GJM0222C1E6R9BB01#
				±0.25pF	GJM0222C1E6R9CB01#

品番 #には包装仕様コードが入ります。

GRMシリーズ
GJMシリーズ
GMAシリーズ
GMDシリーズ
GQMシリーズ
GRJシリーズ
GR3シリーズ
KRMシリーズ
KR3シリーズ
LLAシリーズ
LLLシリーズ
LLMシリーズ
LLRシリーズ
△注意/
使用上の注意

GJMシリーズ 温度補償用 High Q 品番表

(→ ■0.4×0.2mm)

T寸法 最大値	定格 電圧	温度 特性	静電容量	許容差	品番
0.22mm	25Vdc	CH	6.9pF	±0.5pF	GJM0222C1E6R9DB01#
				±0.05pF	GJM0222C1E7R0WB01#
			7.0pF	±0.1pF	GJM0222C1E7R0BB01#
				±0.25pF	GJM0222C1E7R0CB01#
				±0.5pF	GJM0222C1E7R0DB01#
				7.1pF	±0.05pF
			±0.1pF		GJM0222C1E7R1BB01#
			±0.25pF		GJM0222C1E7R1CB01#
			±0.5pF		GJM0222C1E7R1DB01#
			7.2pF	±0.05pF	GJM0222C1E7R2WB01#
				±0.1pF	GJM0222C1E7R2BB01#
				±0.25pF	GJM0222C1E7R2CB01#
				±0.5pF	GJM0222C1E7R2DB01#
			7.3pF	±0.05pF	GJM0222C1E7R3WB01#
				±0.1pF	GJM0222C1E7R3BB01#
				±0.25pF	GJM0222C1E7R3CB01#
				±0.5pF	GJM0222C1E7R3DB01#
			7.4pF	±0.05pF	GJM0222C1E7R4WB01#
				±0.1pF	GJM0222C1E7R4BB01#
				±0.25pF	GJM0222C1E7R4CB01#
				±0.5pF	GJM0222C1E7R4DB01#
			7.5pF	±0.05pF	GJM0222C1E7R5WB01#
				±0.1pF	GJM0222C1E7R5BB01#
				±0.25pF	GJM0222C1E7R5CB01#
				±0.5pF	GJM0222C1E7R5DB01#
			7.6pF	±0.05pF	GJM0222C1E7R6WB01#
				±0.1pF	GJM0222C1E7R6BB01#
				±0.25pF	GJM0222C1E7R6CB01#
				±0.5pF	GJM0222C1E7R6DB01#
			7.7pF	±0.05pF	GJM0222C1E7R7WB01#
				±0.1pF	GJM0222C1E7R7BB01#
				±0.25pF	GJM0222C1E7R7CB01#
				±0.5pF	GJM0222C1E7R7DB01#
			7.8pF	±0.05pF	GJM0222C1E7R8WB01#
				±0.1pF	GJM0222C1E7R8BB01#
				±0.25pF	GJM0222C1E7R8CB01#
				±0.5pF	GJM0222C1E7R8DB01#
			7.9pF	±0.05pF	GJM0222C1E7R9WB01#
				±0.1pF	GJM0222C1E7R9BB01#
				±0.25pF	GJM0222C1E7R9CB01#
				±0.5pF	GJM0222C1E7R9DB01#
			8.0pF	±0.05pF	GJM0222C1E8R0WB01#
				±0.1pF	GJM0222C1E8R0BB01#
				±0.25pF	GJM0222C1E8R0CB01#
				±0.5pF	GJM0222C1E8R0DB01#
			8.1pF	±0.05pF	GJM0222C1E8R1WB01#
				±0.1pF	GJM0222C1E8R1BB01#
				±0.25pF	GJM0222C1E8R1CB01#
±0.5pF	GJM0222C1E8R1DB01#				
8.2pF	±0.05pF	GJM0222C1E8R2WB01#			
	±0.1pF	GJM0222C1E8R2BB01#			
	±0.25pF	GJM0222C1E8R2CB01#			
	±0.5pF	GJM0222C1E8R2DB01#			
8.3pF	±0.05pF	GJM0222C1E8R3WB01#			

T寸法 最大値	定格 電圧	温度 特性	静電容量	許容差	品番
0.22mm	25Vdc	CH	8.3pF	±0.1pF	GJM0222C1E8R3BB01#
				±0.25pF	GJM0222C1E8R3CB01#
				±0.5pF	GJM0222C1E8R3DB01#
			8.4pF	±0.05pF	GJM0222C1E8R4WB01#
				±0.1pF	GJM0222C1E8R4BB01#
				±0.25pF	GJM0222C1E8R4CB01#
			8.5pF	±0.05pF	GJM0222C1E8R5WB01#
				±0.1pF	GJM0222C1E8R5BB01#
				±0.25pF	GJM0222C1E8R5CB01#
			8.6pF	±0.05pF	GJM0222C1E8R6WB01#
				±0.1pF	GJM0222C1E8R6BB01#
				±0.25pF	GJM0222C1E8R6CB01#
			8.7pF	±0.05pF	GJM0222C1E8R7WB01#
				±0.1pF	GJM0222C1E8R7BB01#
				±0.25pF	GJM0222C1E8R7CB01#
			8.8pF	±0.05pF	GJM0222C1E8R8WB01#
				±0.1pF	GJM0222C1E8R8BB01#
				±0.25pF	GJM0222C1E8R8CB01#
			8.9pF	±0.05pF	GJM0222C1E8R9WB01#
				±0.1pF	GJM0222C1E8R9BB01#
				±0.25pF	GJM0222C1E8R9CB01#
			9.0pF	±0.05pF	GJM0222C1E9R0WB01#
				±0.1pF	GJM0222C1E9R0BB01#
				±0.25pF	GJM0222C1E9R0CB01#
			9.1pF	±0.05pF	GJM0222C1E9R1WB01#
				±0.1pF	GJM0222C1E9R1BB01#
				±0.25pF	GJM0222C1E9R1CB01#
			9.2pF	±0.05pF	GJM0222C1E9R2WB01#
				±0.1pF	GJM0222C1E9R2BB01#
				±0.25pF	GJM0222C1E9R2CB01#
			9.3pF	±0.05pF	GJM0222C1E9R3WB01#
				±0.1pF	GJM0222C1E9R3BB01#
				±0.25pF	GJM0222C1E9R3CB01#
			9.4pF	±0.05pF	GJM0222C1E9R4WB01#
				±0.1pF	GJM0222C1E9R4BB01#
				±0.25pF	GJM0222C1E9R4CB01#
			9.5pF	±0.05pF	GJM0222C1E9R5WB01#
				±0.1pF	GJM0222C1E9R5BB01#
				±0.25pF	GJM0222C1E9R5CB01#
			9.6pF	±0.05pF	GJM0222C1E9R6WB01#
				±0.1pF	GJM0222C1E9R6BB01#
				±0.25pF	GJM0222C1E9R6CB01#

品番 #には包装仕様コードが入ります。

GRMシリーズ
 GJMシリーズ
 GMAシリーズ
 GMDシリーズ
 GQMシリーズ
 GRJシリーズ
 GR3シリーズ
 KRMシリーズ
 KR3シリーズ
 LLAシリーズ
 LLLシリーズ
 LLMシリーズ
 LLRシリーズ
 △注意/
 使用上の注意

GJMシリーズ 温度補償用 High Q 品番表

(→ ■0.4×0.2mm)

T寸法 最大値	定格 電圧	温度 特性	静電容量	許容差	品番
0.22mm	25Vdc	CH	9.6pF	±0.5pF	GJM0222C1E9R6DB01#
				±0.05pF	GJM0222C1E9R7WB01#
			9.7pF	±0.1pF	GJM0222C1E9R7BB01#
				±0.25pF	GJM0222C1E9R7CB01#
				±0.5pF	GJM0222C1E9R7DB01#
				9.8pF	±0.05pF
			±0.1pF		GJM0222C1E9R8BB01#
			±0.25pF		GJM0222C1E9R8CB01#
			±0.5pF		GJM0222C1E9R8DB01#
			9.9pF	±0.05pF	GJM0222C1E9R9WB01#
				±0.1pF	GJM0222C1E9R9BB01#
				±0.25pF	GJM0222C1E9R9CB01#
				±0.5pF	GJM0222C1E9R9DB01#
			10pF	±2%	GJM0222C1E100GB01#
				±5%	GJM0222C1E100JB01#
			11pF	±2%	GJM0222C1E110GB01#
				±5%	GJM0222C1E110JB01#
			12pF	±2%	GJM0222C1E120GB01#
				±5%	GJM0222C1E120JB01#
			13pF	±2%	GJM0222C1E130GB01#
				±5%	GJM0222C1E130JB01#
			15pF	±2%	GJM0222C1E150GB01#
				±5%	GJM0222C1E150JB01#
			16pF	±2%	GJM0222C1E160GB01#
		±5%		GJM0222C1E160JB01#	
		18pF	±2%	GJM0222C1E180GB01#	
			±5%	GJM0222C1E180JB01#	
		20pF	±2%	GJM0222C1E200GB01#	
			±5%	GJM0222C1E200JB01#	
		22pF	±2%	GJM0222C1E220GB01#	
			±5%	GJM0222C1E220JB01#	
		COG	0.20pF	±0.05pF	GJM0225C1ER20WB01#
				±0.1pF	GJM0225C1ER20BB01#
			0.30pF	±0.05pF	GJM0225C1ER30WB01#
				±0.1pF	GJM0225C1ER30BB01#
			0.40pF	±0.05pF	GJM0225C1ER40WB01#
				±0.1pF	GJM0225C1ER40BB01#
			0.50pF	±0.05pF	GJM0225C1ER50WB01#
				±0.1pF	GJM0225C1ER50BB01#
			0.60pF	±0.05pF	GJM0225C1ER60WB01#
				±0.1pF	GJM0225C1ER60BB01#
			0.70pF	±0.05pF	GJM0225C1ER70WB01#
				±0.1pF	GJM0225C1ER70BB01#
			0.80pF	±0.05pF	GJM0225C1ER80WB01#
				±0.1pF	GJM0225C1ER80BB01#
			0.90pF	±0.05pF	GJM0225C1ER90WB01#
				±0.1pF	GJM0225C1ER90BB01#
			1.0pF	±0.05pF	GJM0225C1E1R0WB01#
±0.1pF	GJM0225C1E1R0BB01#				
±0.25pF	GJM0225C1E1R0CB01#				
1.1pF	±0.05pF		GJM0225C1E1R1WB01#		
	±0.1pF		GJM0225C1E1R1BB01#		
	±0.25pF		GJM0225C1E1R1CB01#		
1.2pF	±0.05pF		GJM0225C1E1R2WB01#		

T寸法 最大値	定格 電圧	温度 特性	静電容量	許容差	品番
0.22mm	25Vdc	COG	1.2pF	±0.1pF	GJM0225C1E1R2WB01#
				±0.25pF	GJM0225C1E1R2CB01#
			1.3pF	±0.05pF	GJM0225C1E1R3WB01#
				±0.1pF	GJM0225C1E1R3BB01#
				±0.25pF	GJM0225C1E1R3CB01#
				1.4pF	±0.05pF
			±0.1pF		GJM0225C1E1R4BB01#
			±0.25pF		GJM0225C1E1R4CB01#
			1.5pF		±0.05pF
				±0.1pF	GJM0225C1E1R5BB01#
				±0.25pF	GJM0225C1E1R5CB01#
			1.6pF	±0.05pF	GJM0225C1E1R6WB01#
				±0.1pF	GJM0225C1E1R6BB01#
				±0.25pF	GJM0225C1E1R6CB01#
			1.7pF	±0.05pF	GJM0225C1E1R7WB01#
				±0.1pF	GJM0225C1E1R7BB01#
				±0.25pF	GJM0225C1E1R7CB01#
			1.8pF	±0.05pF	GJM0225C1E1R8WB01#
				±0.1pF	GJM0225C1E1R8BB01#
				±0.25pF	GJM0225C1E1R8CB01#
			1.9pF	±0.05pF	GJM0225C1E1R9WB01#
				±0.1pF	GJM0225C1E1R9BB01#
				±0.25pF	GJM0225C1E1R9CB01#
			2.0pF	±0.05pF	GJM0225C1E2R0WB01#
				±0.1pF	GJM0225C1E2R0BB01#
				±0.25pF	GJM0225C1E2R0CB01#
			2.1pF	±0.05pF	GJM0225C1E2R1WB01#
				±0.1pF	GJM0225C1E2R1BB01#
				±0.25pF	GJM0225C1E2R1CB01#
			2.2pF	±0.05pF	GJM0225C1E2R2WB01#
				±0.1pF	GJM0225C1E2R2BB01#
				±0.25pF	GJM0225C1E2R2CB01#
			2.3pF	±0.05pF	GJM0225C1E2R3WB01#
				±0.1pF	GJM0225C1E2R3BB01#
				±0.25pF	GJM0225C1E2R3CB01#
			2.4pF	±0.05pF	GJM0225C1E2R4WB01#
				±0.1pF	GJM0225C1E2R4BB01#
				±0.25pF	GJM0225C1E2R4CB01#
			2.5pF	±0.05pF	GJM0225C1E2R5WB01#
				±0.1pF	GJM0225C1E2R5BB01#
				±0.25pF	GJM0225C1E2R5CB01#
			2.6pF	±0.05pF	GJM0225C1E2R6WB01#
				±0.1pF	GJM0225C1E2R6BB01#
				±0.25pF	GJM0225C1E2R6CB01#
			2.7pF	±0.05pF	GJM0225C1E2R7WB01#
				±0.1pF	GJM0225C1E2R7BB01#
				±0.25pF	GJM0225C1E2R7CB01#
			2.8pF	±0.05pF	GJM0225C1E2R8WB01#
±0.1pF	GJM0225C1E2R8BB01#				
±0.25pF	GJM0225C1E2R8CB01#				
2.9pF	±0.05pF	GJM0225C1E2R9WB01#			
	±0.1pF	GJM0225C1E2R9BB01#			
	±0.25pF	GJM0225C1E2R9CB01#			
3.0pF	±0.05pF	GJM0225C1E3R0WB01#			

品番 #には包装仕様コードが入ります。

GRMSシリーズ
GJMシリーズ
GMAシリーズ
GMDシリーズ
GQMシリーズ
GRJシリーズ
GR3シリーズ
KRMシリーズ
KR3シリーズ
LLAシリーズ
LLLシリーズ
LLMシリーズ
LLRシリーズ
△注意/
使用上の注意

GJMシリーズ 温度補償用 **High Q** 品番表

(→ ■0.4×0.2mm)

T寸法 最大値	定格 電圧	温度 特性	静電容量	許容差	品番
0.22mm	25Vdc	COG	3.0pF	±0.1pF	GJM0225C1E3R0BB01#
				±0.25pF	GJM0225C1E3R0CB01#
			3.1pF	±0.05pF	GJM0225C1E3R1WB01#
				±0.1pF	GJM0225C1E3R1BB01#
				±0.25pF	GJM0225C1E3R1CB01#
				3.2pF	±0.05pF
			±0.1pF		GJM0225C1E3R2BB01#
			±0.25pF		GJM0225C1E3R2CB01#
			3.3pF	±0.05pF	GJM0225C1E3R3WB01#
				±0.1pF	GJM0225C1E3R3BB01#
				±0.25pF	GJM0225C1E3R3CB01#
			3.4pF	±0.05pF	GJM0225C1E3R4WB01#
				±0.1pF	GJM0225C1E3R4BB01#
				±0.25pF	GJM0225C1E3R4CB01#
			3.5pF	±0.05pF	GJM0225C1E3R5WB01#
				±0.1pF	GJM0225C1E3R5BB01#
				±0.25pF	GJM0225C1E3R5CB01#
			3.6pF	±0.05pF	GJM0225C1E3R6WB01#
				±0.1pF	GJM0225C1E3R6BB01#
				±0.25pF	GJM0225C1E3R6CB01#
			3.7pF	±0.05pF	GJM0225C1E3R7WB01#
				±0.1pF	GJM0225C1E3R7BB01#
				±0.25pF	GJM0225C1E3R7CB01#
			3.8pF	±0.05pF	GJM0225C1E3R8WB01#
				±0.1pF	GJM0225C1E3R8BB01#
				±0.25pF	GJM0225C1E3R8CB01#
			3.9pF	±0.05pF	GJM0225C1E3R9WB01#
				±0.1pF	GJM0225C1E3R9BB01#
				±0.25pF	GJM0225C1E3R9CB01#
			4.0pF	±0.05pF	GJM0225C1E4R0WB01#
				±0.1pF	GJM0225C1E4R0BB01#
				±0.25pF	GJM0225C1E4R0CB01#
			4.1pF	±0.05pF	GJM0225C1E4R1WB01#
				±0.1pF	GJM0225C1E4R1BB01#
				±0.25pF	GJM0225C1E4R1CB01#
			4.2pF	±0.05pF	GJM0225C1E4R2WB01#
				±0.1pF	GJM0225C1E4R2BB01#
				±0.25pF	GJM0225C1E4R2CB01#
			4.3pF	±0.05pF	GJM0225C1E4R3WB01#
				±0.1pF	GJM0225C1E4R3BB01#
				±0.25pF	GJM0225C1E4R3CB01#
			4.4pF	±0.05pF	GJM0225C1E4R4WB01#
				±0.1pF	GJM0225C1E4R4BB01#
				±0.25pF	GJM0225C1E4R4CB01#
			4.5pF	±0.05pF	GJM0225C1E4R5WB01#
				±0.1pF	GJM0225C1E4R5BB01#
				±0.25pF	GJM0225C1E4R5CB01#
			4.6pF	±0.05pF	GJM0225C1E4R6WB01#
±0.1pF	GJM0225C1E4R6BB01#				
±0.25pF	GJM0225C1E4R6CB01#				
4.7pF	±0.05pF	GJM0225C1E4R7WB01#			
	±0.1pF	GJM0225C1E4R7BB01#			
	±0.25pF	GJM0225C1E4R7CB01#			
4.8pF	±0.05pF	GJM0225C1E4R8WB01#			
	±0.1pF	GJM0225C1E4R8BB01#			

T寸法 最大値	定格 電圧	温度 特性	静電容量	許容差	品番	
0.22mm	25Vdc	COG	4.8pF	±0.1pF	GJM0225C1E4R8BB01#	
				±0.25pF	GJM0225C1E4R8CB01#	
			4.9pF	±0.05pF	GJM0225C1E4R9WB01#	
				±0.1pF	GJM0225C1E4R9BB01#	
				±0.25pF	GJM0225C1E4R9CB01#	
				5.0pF	±0.05pF	GJM0225C1E5R0WB01#
			±0.1pF		GJM0225C1E5R0BB01#	
			±0.25pF		GJM0225C1E5R0CB01#	
			5.1pF	±0.05pF	GJM0225C1E5R1WB01#	
				±0.1pF	GJM0225C1E5R1BB01#	
				±0.25pF	GJM0225C1E5R1CB01#	
				±0.5pF	GJM0225C1E5R1DB01#	
				5.2pF	±0.05pF	GJM0225C1E5R2WB01#
					±0.1pF	GJM0225C1E5R2BB01#
			±0.25pF		GJM0225C1E5R2CB01#	
				±0.5pF	GJM0225C1E5R2DB01#	
				5.3pF	±0.05pF	GJM0225C1E5R3WB01#
					±0.1pF	GJM0225C1E5R3BB01#
			±0.25pF		GJM0225C1E5R3CB01#	
				±0.5pF	GJM0225C1E5R3DB01#	
				5.4pF	±0.05pF	GJM0225C1E5R4WB01#
					±0.1pF	GJM0225C1E5R4BB01#
			±0.25pF		GJM0225C1E5R4CB01#	
				±0.5pF	GJM0225C1E5R4DB01#	
				5.5pF	±0.05pF	GJM0225C1E5R5WB01#
					±0.1pF	GJM0225C1E5R5BB01#
			±0.25pF		GJM0225C1E5R5CB01#	
				±0.5pF	GJM0225C1E5R5DB01#	
				5.6pF	±0.05pF	GJM0225C1E5R6WB01#
					±0.1pF	GJM0225C1E5R6BB01#
			±0.25pF		GJM0225C1E5R6CB01#	
				±0.5pF	GJM0225C1E5R6DB01#	
				5.7pF	±0.05pF	GJM0225C1E5R7WB01#
					±0.1pF	GJM0225C1E5R7BB01#
			±0.25pF		GJM0225C1E5R7CB01#	
				±0.5pF	GJM0225C1E5R7DB01#	
				5.8pF	±0.05pF	GJM0225C1E5R8WB01#
					±0.1pF	GJM0225C1E5R8BB01#
			±0.25pF		GJM0225C1E5R8CB01#	
				±0.5pF	GJM0225C1E5R8DB01#	
				5.9pF	±0.05pF	GJM0225C1E5R9WB01#
					±0.1pF	GJM0225C1E5R9BB01#
			±0.25pF		GJM0225C1E5R9CB01#	
				±0.5pF	GJM0225C1E5R9DB01#	
				6.0pF	±0.05pF	GJM0225C1E6R0WB01#
					±0.1pF	GJM0225C1E6R0BB01#
			±0.25pF		GJM0225C1E6R0CB01#	
				±0.5pF	GJM0225C1E6R0DB01#	
6.1pF	±0.05pF	GJM0225C1E6R1WB01#				
	±0.1pF	GJM0225C1E6R1BB01#				
	±0.25pF	GJM0225C1E6R1CB01#				
	±0.5pF	GJM0225C1E6R1DB01#				
	6.2pF	±0.05pF	GJM0225C1E6R2WB01#			
		±0.1pF	GJM0225C1E6R2BB01#			

品番 #には包装仕様コードが入ります。

GRMシリーズ
 GJMシリーズ
 GMAシリーズ
 GMDシリーズ
 GQMシリーズ
 GRJシリーズ
 GR3シリーズ
 KRMシリーズ
 KR3シリーズ
 LLAシリーズ
 LLLシリーズ
 LLMシリーズ
 LLRシリーズ
 △注意/
 使用上の注意

GJMシリーズ 温度補償用 High Q 品番表

(→ ■0.4×0.2mm)

T寸法 最大値	定格 電圧	温度 特性	静電容量	許容差	品番
0.22mm	25Vdc	COG	6.2pF	±0.25pF	GJM0225C1E6R2CB01#
				±0.5pF	GJM0225C1E6R2DB01#
			6.3pF	±0.05pF	GJM0225C1E6R3WB01#
				±0.1pF	GJM0225C1E6R3BB01#
				±0.25pF	GJM0225C1E6R3CB01#
				±0.5pF	GJM0225C1E6R3DB01#
			6.4pF	±0.05pF	GJM0225C1E6R4WB01#
				±0.1pF	GJM0225C1E6R4BB01#
				±0.25pF	GJM0225C1E6R4CB01#
				±0.5pF	GJM0225C1E6R4DB01#
			6.5pF	±0.05pF	GJM0225C1E6R5WB01#
				±0.1pF	GJM0225C1E6R5BB01#
				±0.25pF	GJM0225C1E6R5CB01#
				±0.5pF	GJM0225C1E6R5DB01#
			6.6pF	±0.05pF	GJM0225C1E6R6WB01#
				±0.1pF	GJM0225C1E6R6BB01#
				±0.25pF	GJM0225C1E6R6CB01#
				±0.5pF	GJM0225C1E6R6DB01#
			6.7pF	±0.05pF	GJM0225C1E6R7WB01#
				±0.1pF	GJM0225C1E6R7BB01#
				±0.25pF	GJM0225C1E6R7CB01#
				±0.5pF	GJM0225C1E6R7DB01#
			6.8pF	±0.05pF	GJM0225C1E6R8WB01#
				±0.1pF	GJM0225C1E6R8BB01#
				±0.25pF	GJM0225C1E6R8CB01#
				±0.5pF	GJM0225C1E6R8DB01#
			6.9pF	±0.05pF	GJM0225C1E6R9WB01#
				±0.1pF	GJM0225C1E6R9BB01#
				±0.25pF	GJM0225C1E6R9CB01#
				±0.5pF	GJM0225C1E6R9DB01#
			7.0pF	±0.05pF	GJM0225C1E7R0WB01#
				±0.1pF	GJM0225C1E7R0BB01#
				±0.25pF	GJM0225C1E7R0CB01#
				±0.5pF	GJM0225C1E7R0DB01#
			7.1pF	±0.05pF	GJM0225C1E7R1WB01#
				±0.1pF	GJM0225C1E7R1BB01#
				±0.25pF	GJM0225C1E7R1CB01#
				±0.5pF	GJM0225C1E7R1DB01#
			7.2pF	±0.05pF	GJM0225C1E7R2WB01#
				±0.1pF	GJM0225C1E7R2BB01#
				±0.25pF	GJM0225C1E7R2CB01#
				±0.5pF	GJM0225C1E7R2DB01#
			7.3pF	±0.05pF	GJM0225C1E7R3WB01#
				±0.1pF	GJM0225C1E7R3BB01#
				±0.25pF	GJM0225C1E7R3CB01#
±0.5pF	GJM0225C1E7R3DB01#				
7.4pF	±0.05pF	GJM0225C1E7R4WB01#			
	±0.1pF	GJM0225C1E7R4BB01#			
	±0.25pF	GJM0225C1E7R4CB01#			
	±0.5pF	GJM0225C1E7R4DB01#			
7.5pF	±0.05pF	GJM0225C1E7R5WB01#			
	±0.1pF	GJM0225C1E7R5BB01#			
	±0.25pF	GJM0225C1E7R5CB01#			
	±0.5pF	GJM0225C1E7R5DB01#			

T寸法 最大値	定格 電圧	温度 特性	静電容量	許容差	品番
0.22mm	25Vdc	COG	7.6pF	±0.05pF	GJM0225C1E7R6WB01#
				±0.1pF	GJM0225C1E7R6BB01#
				±0.25pF	GJM0225C1E7R6CB01#
				±0.5pF	GJM0225C1E7R6DB01#
			7.7pF	±0.05pF	GJM0225C1E7R7WB01#
				±0.1pF	GJM0225C1E7R7BB01#
				±0.25pF	GJM0225C1E7R7CB01#
				±0.5pF	GJM0225C1E7R7DB01#
			7.8pF	±0.05pF	GJM0225C1E7R8WB01#
				±0.1pF	GJM0225C1E7R8BB01#
				±0.25pF	GJM0225C1E7R8CB01#
				±0.5pF	GJM0225C1E7R8DB01#
			7.9pF	±0.05pF	GJM0225C1E7R9WB01#
				±0.1pF	GJM0225C1E7R9BB01#
				±0.25pF	GJM0225C1E7R9CB01#
				±0.5pF	GJM0225C1E7R9DB01#
			8.0pF	±0.05pF	GJM0225C1E8R0WB01#
				±0.1pF	GJM0225C1E8R0BB01#
				±0.25pF	GJM0225C1E8R0CB01#
				±0.5pF	GJM0225C1E8R0DB01#
			8.1pF	±0.05pF	GJM0225C1E8R1WB01#
				±0.1pF	GJM0225C1E8R1BB01#
				±0.25pF	GJM0225C1E8R1CB01#
				±0.5pF	GJM0225C1E8R1DB01#
			8.2pF	±0.05pF	GJM0225C1E8R2WB01#
				±0.1pF	GJM0225C1E8R2BB01#
				±0.25pF	GJM0225C1E8R2CB01#
				±0.5pF	GJM0225C1E8R2DB01#
			8.3pF	±0.05pF	GJM0225C1E8R3WB01#
				±0.1pF	GJM0225C1E8R3BB01#
				±0.25pF	GJM0225C1E8R3CB01#
				±0.5pF	GJM0225C1E8R3DB01#
			8.4pF	±0.05pF	GJM0225C1E8R4WB01#
				±0.1pF	GJM0225C1E8R4BB01#
				±0.25pF	GJM0225C1E8R4CB01#
				±0.5pF	GJM0225C1E8R4DB01#
			8.5pF	±0.05pF	GJM0225C1E8R5WB01#
				±0.1pF	GJM0225C1E8R5BB01#
				±0.25pF	GJM0225C1E8R5CB01#
				±0.5pF	GJM0225C1E8R5DB01#
			8.6pF	±0.05pF	GJM0225C1E8R6WB01#
				±0.1pF	GJM0225C1E8R6BB01#
				±0.25pF	GJM0225C1E8R6CB01#
				±0.5pF	GJM0225C1E8R6DB01#
			8.7pF	±0.05pF	GJM0225C1E8R7WB01#
±0.1pF	GJM0225C1E8R7BB01#				
±0.25pF	GJM0225C1E8R7CB01#				
±0.5pF	GJM0225C1E8R7DB01#				
8.8pF	±0.05pF	GJM0225C1E8R8WB01#			
	±0.1pF	GJM0225C1E8R8BB01#			
	±0.25pF	GJM0225C1E8R8CB01#			
	±0.5pF	GJM0225C1E8R8DB01#			
8.9pF	±0.05pF	GJM0225C1E8R9WB01#			
	±0.1pF	GJM0225C1E8R9BB01#			

品番 #には包装仕様コードが入ります。

GRMシリーズ
GJMシリーズ
GMAシリーズ
GMDシリーズ
GQMシリーズ
GRJシリーズ
GR3シリーズ
KRMシリーズ
KR3シリーズ
LLAシリーズ
LLLシリーズ
LLMシリーズ
LLRシリーズ
△注意/
使用上の注意

GJMシリーズ 温度補償用 High Q 品番表

(→ ■0.4×0.2mm)

T寸法 最大値	定格 電圧	温度 特性	静電容量	許容差	品番
0.22mm	25Vdc	COG	8.9pF	±0.25pF	GJM0225C1E8R9CB01#
				±0.5pF	GJM0225C1E8R9DB01#
			9.0pF	±0.05pF	GJM0225C1E9R0WB01#
				±0.1pF	GJM0225C1E9R0BB01#
				±0.25pF	GJM0225C1E9R0CB01#
				±0.5pF	GJM0225C1E9R0DB01#
			9.1pF	±0.05pF	GJM0225C1E9R1WB01#
				±0.1pF	GJM0225C1E9R1BB01#
				±0.25pF	GJM0225C1E9R1CB01#
				±0.5pF	GJM0225C1E9R1DB01#
			9.2pF	±0.05pF	GJM0225C1E9R2WB01#
				±0.1pF	GJM0225C1E9R2BB01#
				±0.25pF	GJM0225C1E9R2CB01#
				±0.5pF	GJM0225C1E9R2DB01#
			9.3pF	±0.05pF	GJM0225C1E9R3WB01#
				±0.1pF	GJM0225C1E9R3BB01#
				±0.25pF	GJM0225C1E9R3CB01#
				±0.5pF	GJM0225C1E9R3DB01#
			9.4pF	±0.05pF	GJM0225C1E9R4WB01#
				±0.1pF	GJM0225C1E9R4BB01#
				±0.25pF	GJM0225C1E9R4CB01#
				±0.5pF	GJM0225C1E9R4DB01#
			9.5pF	±0.05pF	GJM0225C1E9R5WB01#
				±0.1pF	GJM0225C1E9R5BB01#
				±0.25pF	GJM0225C1E9R5CB01#
				±0.5pF	GJM0225C1E9R5DB01#
			9.6pF	±0.05pF	GJM0225C1E9R6WB01#
				±0.1pF	GJM0225C1E9R6BB01#
				±0.25pF	GJM0225C1E9R6CB01#
				±0.5pF	GJM0225C1E9R6DB01#
			9.7pF	±0.05pF	GJM0225C1E9R7WB01#
				±0.1pF	GJM0225C1E9R7BB01#
				±0.25pF	GJM0225C1E9R7CB01#
				±0.5pF	GJM0225C1E9R7DB01#
			9.8pF	±0.05pF	GJM0225C1E9R8WB01#
				±0.1pF	GJM0225C1E9R8BB01#
				±0.25pF	GJM0225C1E9R8CB01#
				±0.5pF	GJM0225C1E9R8DB01#
			9.9pF	±0.05pF	GJM0225C1E9R9WB01#
				±0.1pF	GJM0225C1E9R9BB01#
				±0.25pF	GJM0225C1E9R9CB01#
				±0.5pF	GJM0225C1E9R9DB01#
			10pF	±2%	GJM0225C1E100GB01#
				±5%	GJM0225C1E100JB01#
			11pF	±2%	GJM0225C1E110GB01#
				±5%	GJM0225C1E110JB01#
			12pF	±2%	GJM0225C1E120GB01#
				±5%	GJM0225C1E120JB01#
13pF	±2%	GJM0225C1E130GB01#			
	±5%	GJM0225C1E130JB01#			
15pF	±2%	GJM0225C1E150GB01#			
	±5%	GJM0225C1E150JB01#			
16pF	±2%	GJM0225C1E160GB01#			
	±5%	GJM0225C1E160JB01#			

T寸法 最大値	定格 電圧	温度 特性	静電容量	許容差	品番
0.22mm	25Vdc	COG	18pF	±2%	GJM0225C1E180GB01#
				±5%	GJM0225C1E180JB01#
			20pF	±2%	GJM0225C1E200GB01#
				±5%	GJM0225C1E200JB01#
			22pF	±2%	GJM0225C1E220GB01#
				±5%	GJM0225C1E220JB01#

■0.6×0.3mm 超小型

T寸法 最大値	定格 電圧	温度 特性	静電容量	許容差	品番
0.33mm	25Vdc	CK	0.20pF	±0.05pF	GJM0334C1ER20WB01#
				±0.1pF	GJM0334C1ER20BB01#
			0.30pF	±0.05pF	GJM0334C1ER30WB01#
				±0.1pF	GJM0334C1ER30BB01#
			0.40pF	±0.05pF	GJM0334C1ER40WB01#
				±0.1pF	GJM0334C1ER40BB01#
			0.50pF	±0.05pF	GJM0334C1ER50WB01#
				±0.1pF	GJM0334C1ER50BB01#
			0.60pF	±0.05pF	GJM0334C1ER60WB01#
				±0.1pF	GJM0334C1ER60BB01#
			0.70pF	±0.05pF	GJM0334C1ER70WB01#
				±0.1pF	GJM0334C1ER70BB01#
			0.80pF	±0.05pF	GJM0334C1ER80WB01#
				±0.1pF	GJM0334C1ER80BB01#
			0.90pF	±0.05pF	GJM0334C1ER90WB01#
				±0.1pF	GJM0334C1ER90BB01#
			1.0pF	±0.05pF	GJM0334C1E1R0WB01#
				±0.1pF	GJM0334C1E1R0BB01#
				±0.25pF	GJM0334C1E1R0CB01#
			1.1pF	±0.05pF	GJM0334C1E1R1WB01#
				±0.1pF	GJM0334C1E1R1BB01#
				±0.25pF	GJM0334C1E1R1CB01#
			1.2pF	±0.05pF	GJM0334C1E1R2WB01#
				±0.1pF	GJM0334C1E1R2BB01#
				±0.25pF	GJM0334C1E1R2CB01#
			1.3pF	±0.05pF	GJM0334C1E1R3WB01#
				±0.1pF	GJM0334C1E1R3BB01#
				±0.25pF	GJM0334C1E1R3CB01#
			1.4pF	±0.05pF	GJM0334C1E1R4WB01#
				±0.1pF	GJM0334C1E1R4BB01#
				±0.25pF	GJM0334C1E1R4CB01#
			1.5pF	±0.05pF	GJM0334C1E1R5WB01#
				±0.1pF	GJM0334C1E1R5BB01#
				±0.25pF	GJM0334C1E1R5CB01#
			1.6pF	±0.05pF	GJM0334C1E1R6WB01#
				±0.1pF	GJM0334C1E1R6BB01#
				±0.25pF	GJM0334C1E1R6CB01#
			1.7pF	±0.05pF	GJM0334C1E1R7WB01#
				±0.1pF	GJM0334C1E1R7BB01#
				±0.25pF	GJM0334C1E1R7CB01#
			1.8pF	±0.05pF	GJM0334C1E1R8WB01#
				±0.1pF	GJM0334C1E1R8BB01#
				±0.25pF	GJM0334C1E1R8CB01#

品番 #には包装仕様コードが入ります。

GRMシリーズ
 GJMシリーズ
 GMAシリーズ
 GMDシリーズ
 GQMシリーズ
 GRJシリーズ
 GR3シリーズ
 KRMシリーズ
 KR3シリーズ
 LLAシリーズ
 LLLシリーズ
 LLMシリーズ
 LLRシリーズ
 △注意/
 使用上の注意

GJMシリーズ 温度補償用 High Q 品番表

(→ ■0.6×0.3mm)

T寸法 最大値	定格 電圧	温度 特性	静電容量	許容差	品番	
0.33mm	25Vdc	CK	1.9pF	±0.05pF	GJM0334C1E1R9WB01#	
				±0.1pF	GJM0334C1E1R9BB01#	
				±0.25pF	GJM0334C1E1R9CB01#	
			2.0pF	±0.05pF	GJM0334C1E2R0WB01#	
				±0.1pF	GJM0334C1E2R0BB01#	
				±0.25pF	GJM0334C1E2R0CB01#	
			CJ	2.1pF	±0.05pF	GJM0333C1E2R1WB01#
					±0.1pF	GJM0333C1E2R1BB01#
					±0.25pF	GJM0333C1E2R1CB01#
				2.2pF	±0.05pF	GJM0333C1E2R2WB01#
					±0.1pF	GJM0333C1E2R2BB01#
					±0.25pF	GJM0333C1E2R2CB01#
		2.3pF		±0.05pF	GJM0333C1E2R3WB01#	
				±0.1pF	GJM0333C1E2R3BB01#	
				±0.25pF	GJM0333C1E2R3CB01#	
		2.4pF		±0.05pF	GJM0333C1E2R4WB01#	
				±0.1pF	GJM0333C1E2R4BB01#	
				±0.25pF	GJM0333C1E2R4CB01#	
		2.5pF		±0.05pF	GJM0333C1E2R5WB01#	
				±0.1pF	GJM0333C1E2R5BB01#	
				±0.25pF	GJM0333C1E2R5CB01#	
		2.6pF		±0.05pF	GJM0333C1E2R6WB01#	
				±0.1pF	GJM0333C1E2R6BB01#	
				±0.25pF	GJM0333C1E2R6CB01#	
		2.7pF		±0.05pF	GJM0333C1E2R7WB01#	
				±0.1pF	GJM0333C1E2R7BB01#	
				±0.25pF	GJM0333C1E2R7CB01#	
		2.8pF		±0.05pF	GJM0333C1E2R8WB01#	
				±0.1pF	GJM0333C1E2R8BB01#	
				±0.25pF	GJM0333C1E2R8CB01#	
		2.9pF		±0.05pF	GJM0333C1E2R9WB01#	
				±0.1pF	GJM0333C1E2R9BB01#	
				±0.25pF	GJM0333C1E2R9CB01#	
		3.0pF		±0.05pF	GJM0333C1E3R0WB01#	
				±0.1pF	GJM0333C1E3R0BB01#	
				±0.25pF	GJM0333C1E3R0CB01#	
		3.1pF		±0.05pF	GJM0333C1E3R1WB01#	
				±0.1pF	GJM0333C1E3R1BB01#	
				±0.25pF	GJM0333C1E3R1CB01#	
		3.2pF		±0.05pF	GJM0333C1E3R2WB01#	
				±0.1pF	GJM0333C1E3R2BB01#	
				±0.25pF	GJM0333C1E3R2CB01#	
		3.3pF	±0.05pF	GJM0333C1E3R3WB01#		
			±0.1pF	GJM0333C1E3R3BB01#		
			±0.25pF	GJM0333C1E3R3CB01#		
		3.4pF	±0.05pF	GJM0333C1E3R4WB01#		
			±0.1pF	GJM0333C1E3R4BB01#		
			±0.25pF	GJM0333C1E3R4CB01#		
3.5pF	±0.05pF	GJM0333C1E3R5WB01#				
	±0.1pF	GJM0333C1E3R5BB01#				
	±0.25pF	GJM0333C1E3R5CB01#				
3.6pF	±0.05pF	GJM0333C1E3R6WB01#				
	±0.1pF	GJM0333C1E3R6BB01#				
	±0.25pF	GJM0333C1E3R6CB01#				

T寸法 最大値	定格 電圧	温度 特性	静電容量	許容差	品番	
0.33mm	25Vdc	CJ	3.7pF	±0.05pF	GJM0333C1E3R7WB01#	
				±0.1pF	GJM0333C1E3R7BB01#	
				±0.25pF	GJM0333C1E3R7CB01#	
			3.8pF	±0.05pF	GJM0333C1E3R8WB01#	
				±0.1pF	GJM0333C1E3R8BB01#	
				±0.25pF	GJM0333C1E3R8CB01#	
			3.9pF	±0.05pF	GJM0333C1E3R9WB01#	
				±0.1pF	GJM0333C1E3R9BB01#	
				±0.25pF	GJM0333C1E3R9CB01#	
			CH	4.0pF	±0.05pF	GJM0332C1E4R0WB01#
					±0.1pF	GJM0332C1E4R0BB01#
					±0.25pF	GJM0332C1E4R0CB01#
		4.1pF		±0.05pF	GJM0332C1E4R1WB01#	
				±0.1pF	GJM0332C1E4R1BB01#	
				±0.25pF	GJM0332C1E4R1CB01#	
		4.2pF		±0.05pF	GJM0332C1E4R2WB01#	
				±0.1pF	GJM0332C1E4R2BB01#	
				±0.25pF	GJM0332C1E4R2CB01#	
		4.3pF		±0.05pF	GJM0332C1E4R3WB01#	
				±0.1pF	GJM0332C1E4R3BB01#	
				±0.25pF	GJM0332C1E4R3CB01#	
		4.4pF		±0.05pF	GJM0332C1E4R4WB01#	
				±0.1pF	GJM0332C1E4R4BB01#	
				±0.25pF	GJM0332C1E4R4CB01#	
		4.5pF		±0.05pF	GJM0332C1E4R5WB01#	
				±0.1pF	GJM0332C1E4R5BB01#	
				±0.25pF	GJM0332C1E4R5CB01#	
		4.6pF		±0.05pF	GJM0332C1E4R6WB01#	
				±0.1pF	GJM0332C1E4R6BB01#	
				±0.25pF	GJM0332C1E4R6CB01#	
		4.7pF		±0.05pF	GJM0332C1E4R7WB01#	
				±0.1pF	GJM0332C1E4R7BB01#	
				±0.25pF	GJM0332C1E4R7CB01#	
		4.8pF		±0.05pF	GJM0332C1E4R8WB01#	
				±0.1pF	GJM0332C1E4R8BB01#	
				±0.25pF	GJM0332C1E4R8CB01#	
		4.9pF		±0.05pF	GJM0332C1E4R9WB01#	
				±0.1pF	GJM0332C1E4R9BB01#	
				±0.25pF	GJM0332C1E4R9CB01#	
		5.0pF		±0.05pF	GJM0332C1E5R0WB01#	
				±0.1pF	GJM0332C1E5R0BB01#	
				±0.25pF	GJM0332C1E5R0CB01#	
		5.1pF		±0.05pF	GJM0332C1E5R1WB01#	
				±0.1pF	GJM0332C1E5R1BB01#	
				±0.25pF	GJM0332C1E5R1CB01#	
		5.2pF	±0.05pF	GJM0332C1E5R2WB01#		
			±0.1pF	GJM0332C1E5R2BB01#		
			±0.5pF	GJM0332C1E5R1DB01#		
5.3pF	±0.05pF	GJM0332C1E5R3WB01#				
	±0.1pF	GJM0332C1E5R3BB01#				
	±0.25pF	GJM0332C1E5R3CB01#				
		±0.5pF	GJM0332C1E5R3DB01#			

品番 #には包装仕様コードが入ります。

GRMSシリーズ
GJMシリーズ
GMAシリーズ
GMDシリーズ
GQMシリーズ
GRJシリーズ
GR3シリーズ
KRMシリーズ
KR3シリーズ
LLAシリーズ
LLLシリーズ
LLMシリーズ
LLRシリーズ
△注意/
使用上の注意

GJMシリーズ 温度補償用 High Q 品番表

(→ ■0.6×0.3mm)

T寸法 最大値	定格 電圧	温度 特性	静電容量	許容差	品番
0.33mm	25Vdc	CH	5.4pF	±0.05pF	GJM0332C1E5R4WB01#
				±0.1pF	GJM0332C1E5R4BB01#
				±0.25pF	GJM0332C1E5R4CB01#
				±0.5pF	GJM0332C1E5R4DB01#
			5.5pF	±0.05pF	GJM0332C1E5R5WB01#
				±0.1pF	GJM0332C1E5R5BB01#
				±0.25pF	GJM0332C1E5R5CB01#
				±0.5pF	GJM0332C1E5R5DB01#
			5.6pF	±0.05pF	GJM0332C1E5R6WB01#
				±0.1pF	GJM0332C1E5R6BB01#
				±0.25pF	GJM0332C1E5R6CB01#
				±0.5pF	GJM0332C1E5R6DB01#
			5.7pF	±0.05pF	GJM0332C1E5R7WB01#
				±0.1pF	GJM0332C1E5R7BB01#
				±0.25pF	GJM0332C1E5R7CB01#
				±0.5pF	GJM0332C1E5R7DB01#
			5.8pF	±0.05pF	GJM0332C1E5R8WB01#
				±0.1pF	GJM0332C1E5R8BB01#
				±0.25pF	GJM0332C1E5R8CB01#
				±0.5pF	GJM0332C1E5R8DB01#
			5.9pF	±0.05pF	GJM0332C1E5R9WB01#
				±0.1pF	GJM0332C1E5R9BB01#
				±0.25pF	GJM0332C1E5R9CB01#
				±0.5pF	GJM0332C1E5R9DB01#
			6.0pF	±0.05pF	GJM0332C1E6R0WB01#
				±0.1pF	GJM0332C1E6R0BB01#
				±0.25pF	GJM0332C1E6R0CB01#
				±0.5pF	GJM0332C1E6R0DB01#
			6.1pF	±0.05pF	GJM0332C1E6R1WB01#
				±0.1pF	GJM0332C1E6R1BB01#
				±0.25pF	GJM0332C1E6R1CB01#
				±0.5pF	GJM0332C1E6R1DB01#
			6.2pF	±0.05pF	GJM0332C1E6R2WB01#
				±0.1pF	GJM0332C1E6R2BB01#
				±0.25pF	GJM0332C1E6R2CB01#
				±0.5pF	GJM0332C1E6R2DB01#
			6.3pF	±0.05pF	GJM0332C1E6R3WB01#
				±0.1pF	GJM0332C1E6R3BB01#
				±0.25pF	GJM0332C1E6R3CB01#
				±0.5pF	GJM0332C1E6R3DB01#
			6.4pF	±0.05pF	GJM0332C1E6R4WB01#
				±0.1pF	GJM0332C1E6R4BB01#
				±0.25pF	GJM0332C1E6R4CB01#
				±0.5pF	GJM0332C1E6R4DB01#
			6.5pF	±0.05pF	GJM0332C1E6R5WB01#
				±0.1pF	GJM0332C1E6R5BB01#
				±0.25pF	GJM0332C1E6R5CB01#
				±0.5pF	GJM0332C1E6R5DB01#
6.6pF	±0.05pF	GJM0332C1E6R6WB01#			
	±0.1pF	GJM0332C1E6R6BB01#			
	±0.25pF	GJM0332C1E6R6CB01#			
	±0.5pF	GJM0332C1E6R6DB01#			
6.7pF	±0.05pF	GJM0332C1E6R7WB01#			
	±0.1pF	GJM0332C1E6R7BB01#			

T寸法 最大値	定格 電圧	温度 特性	静電容量	許容差	品番
0.33mm	25Vdc	CH	6.7pF	±0.25pF	GJM0332C1E6R7CB01#
				±0.5pF	GJM0332C1E6R7DB01#
			6.8pF	±0.05pF	GJM0332C1E6R8WB01#
				±0.1pF	GJM0332C1E6R8BB01#
				±0.25pF	GJM0332C1E6R8CB01#
			6.9pF	±0.05pF	GJM0332C1E6R9WB01#
				±0.1pF	GJM0332C1E6R9BB01#
				±0.25pF	GJM0332C1E6R9CB01#
			7.0pF	±0.05pF	GJM0332C1E7R0WB01#
				±0.1pF	GJM0332C1E7R0BB01#
				±0.25pF	GJM0332C1E7R0CB01#
			7.1pF	±0.05pF	GJM0332C1E7R1WB01#
				±0.1pF	GJM0332C1E7R1BB01#
				±0.25pF	GJM0332C1E7R1CB01#
			7.2pF	±0.05pF	GJM0332C1E7R2WB01#
				±0.1pF	GJM0332C1E7R2BB01#
				±0.25pF	GJM0332C1E7R2CB01#
			7.3pF	±0.05pF	GJM0332C1E7R3WB01#
				±0.1pF	GJM0332C1E7R3BB01#
				±0.25pF	GJM0332C1E7R3CB01#
			7.4pF	±0.05pF	GJM0332C1E7R4WB01#
				±0.1pF	GJM0332C1E7R4BB01#
				±0.25pF	GJM0332C1E7R4CB01#
			7.5pF	±0.05pF	GJM0332C1E7R5WB01#
				±0.1pF	GJM0332C1E7R5BB01#
				±0.25pF	GJM0332C1E7R5CB01#
			7.6pF	±0.05pF	GJM0332C1E7R6WB01#
				±0.1pF	GJM0332C1E7R6BB01#
				±0.25pF	GJM0332C1E7R6CB01#
			7.7pF	±0.05pF	GJM0332C1E7R7WB01#
				±0.1pF	GJM0332C1E7R7BB01#
				±0.25pF	GJM0332C1E7R7CB01#
			7.8pF	±0.05pF	GJM0332C1E7R8WB01#
				±0.1pF	GJM0332C1E7R8BB01#
				±0.25pF	GJM0332C1E7R8CB01#
			7.9pF	±0.05pF	GJM0332C1E7R9WB01#
				±0.1pF	GJM0332C1E7R9BB01#
				±0.25pF	GJM0332C1E7R9CB01#
			8.0pF	±0.05pF	GJM0332C1E8R0WB01#
				±0.1pF	GJM0332C1E8R0BB01#
				±0.25pF	GJM0332C1E8R0CB01#

品番 #には包装仕様コードが入ります。

GRMシリーズ
 GJMシリーズ
 GMAシリーズ
 GMDシリーズ
 GQMシリーズ
 GRJシリーズ
 GR3シリーズ
 KRMシリーズ
 KR3シリーズ
 LLAシリーズ
 LLLシリーズ
 LLMシリーズ
 LLRシリーズ
 △注意/
 使用上の注意

GJMシリーズ 温度補償用 High Q 品番表

(→ ■0.6×0.3mm)

T寸法 最大値	定格 電圧	温度 特性	静電容量	許容差	品番
0.33mm	25Vdc	CH	8.1pF	±0.05pF	GJM0332C1E8R1WB01#
				±0.1pF	GJM0332C1E8R1BB01#
				±0.25pF	GJM0332C1E8R1CB01#
				±0.5pF	GJM0332C1E8R1DB01#
			8.2pF	±0.05pF	GJM0332C1E8R2WB01#
				±0.1pF	GJM0332C1E8R2BB01#
				±0.25pF	GJM0332C1E8R2CB01#
				±0.5pF	GJM0332C1E8R2DB01#
			8.3pF	±0.05pF	GJM0332C1E8R3WB01#
				±0.1pF	GJM0332C1E8R3BB01#
				±0.25pF	GJM0332C1E8R3CB01#
				±0.5pF	GJM0332C1E8R3DB01#
			8.4pF	±0.05pF	GJM0332C1E8R4WB01#
				±0.1pF	GJM0332C1E8R4BB01#
				±0.25pF	GJM0332C1E8R4CB01#
				±0.5pF	GJM0332C1E8R4DB01#
			8.5pF	±0.05pF	GJM0332C1E8R5WB01#
				±0.1pF	GJM0332C1E8R5BB01#
				±0.25pF	GJM0332C1E8R5CB01#
				±0.5pF	GJM0332C1E8R5DB01#
			8.6pF	±0.05pF	GJM0332C1E8R6WB01#
				±0.1pF	GJM0332C1E8R6BB01#
				±0.25pF	GJM0332C1E8R6CB01#
				±0.5pF	GJM0332C1E8R6DB01#
			8.7pF	±0.05pF	GJM0332C1E8R7WB01#
				±0.1pF	GJM0332C1E8R7BB01#
				±0.25pF	GJM0332C1E8R7CB01#
				±0.5pF	GJM0332C1E8R7DB01#
			8.8pF	±0.05pF	GJM0332C1E8R8WB01#
				±0.1pF	GJM0332C1E8R8BB01#
				±0.25pF	GJM0332C1E8R8CB01#
				±0.5pF	GJM0332C1E8R8DB01#
			8.9pF	±0.05pF	GJM0332C1E8R9WB01#
				±0.1pF	GJM0332C1E8R9BB01#
				±0.25pF	GJM0332C1E8R9CB01#
				±0.5pF	GJM0332C1E8R9DB01#
			9.0pF	±0.05pF	GJM0332C1E9R0WB01#
				±0.1pF	GJM0332C1E9R0BB01#
				±0.25pF	GJM0332C1E9R0CB01#
				±0.5pF	GJM0332C1E9R0DB01#
			9.1pF	±0.05pF	GJM0332C1E9R1WB01#
				±0.1pF	GJM0332C1E9R1BB01#
				±0.25pF	GJM0332C1E9R1CB01#
				±0.5pF	GJM0332C1E9R1DB01#
			9.2pF	±0.05pF	GJM0332C1E9R2WB01#
				±0.1pF	GJM0332C1E9R2BB01#
				±0.25pF	GJM0332C1E9R2CB01#
				±0.5pF	GJM0332C1E9R2DB01#
9.3pF	±0.05pF	GJM0332C1E9R3WB01#			
	±0.1pF	GJM0332C1E9R3BB01#			
	±0.25pF	GJM0332C1E9R3CB01#			
	±0.5pF	GJM0332C1E9R3DB01#			
9.4pF	±0.05pF	GJM0332C1E9R4WB01#			
	±0.1pF	GJM0332C1E9R4BB01#			

T寸法 最大値	定格 電圧	温度 特性	静電容量	許容差	品番
0.33mm	25Vdc	CH	9.4pF	±0.25pF	GJM0332C1E9R4CB01#
				±0.5pF	GJM0332C1E9R4DB01#
			9.5pF	±0.05pF	GJM0332C1E9R5WB01#
				±0.1pF	GJM0332C1E9R5BB01#
				±0.25pF	GJM0332C1E9R5CB01#
				±0.5pF	GJM0332C1E9R5DB01#
			9.6pF	±0.05pF	GJM0332C1E9R6WB01#
				±0.1pF	GJM0332C1E9R6BB01#
				±0.25pF	GJM0332C1E9R6CB01#
				±0.5pF	GJM0332C1E9R6DB01#
				9.7pF	±0.05pF
			±0.1pF		GJM0332C1E9R7BB01#
			±0.25pF		GJM0332C1E9R7CB01#
				±0.5pF	GJM0332C1E9R7DB01#
				9.8pF	±0.05pF
			±0.1pF		GJM0332C1E9R8BB01#
			±0.25pF		GJM0332C1E9R8CB01#
				±0.5pF	GJM0332C1E9R8DB01#
				9.9pF	±0.05pF
			±0.1pF		GJM0332C1E9R9BB01#
			±0.25pF		GJM0332C1E9R9CB01#
				±0.5pF	GJM0332C1E9R9DB01#
				10pF	±2%
			±5%		GJM0332C1E100JB01#
		11pF	±2%	GJM0332C1E110GB01#	
			±5%	GJM0332C1E110JB01#	
		12pF	±2%	GJM0332C1E120GB01#	
			±5%	GJM0332C1E120JB01#	
		13pF	±2%	GJM0332C1E130GB01#	
			±5%	GJM0332C1E130JB01#	
		15pF	±2%	GJM0332C1E150GB01#	
			±5%	GJM0332C1E150JB01#	
		16pF	±2%	GJM0332C1E160GB01#	
			±5%	GJM0332C1E160JB01#	
		18pF	±2%	GJM0332C1E180GB01#	
			±5%	GJM0332C1E180JB01#	
		20pF	±2%	GJM0332C1E200GB01#	
			±5%	GJM0332C1E200JB01#	
		22pF	±2%	GJM0332C1E220GB01#	
			±5%	GJM0332C1E220JB01#	
		24pF	±2%	GJM0332C1E240GB01#	
			±5%	GJM0332C1E240JB01#	
		27pF	±2%	GJM0332C1E270GB01#	
			±5%	GJM0332C1E270JB01#	
		30pF	±2%	GJM0332C1E300GB01#	
			±5%	GJM0332C1E300JB01#	
		33pF	±2%	GJM0332C1E330GB01#	
			±5%	GJM0332C1E330JB01#	
C0G	0.20pF	±0.05pF	GJM0335C1ER20WB01#		
		±0.1pF	GJM0335C1ER20BB01#		
	0.30pF	±0.05pF	GJM0335C1ER30WB01#		
		±0.1pF	GJM0335C1ER30BB01#		
	0.40pF	±0.05pF	GJM0335C1ER40WB01#		
		±0.1pF	GJM0335C1ER40BB01#		

品番 #には包装仕様コードが入ります。

GRMシリーズ
GJMシリーズ
GMAシリーズ
GMDシリーズ
GQMシリーズ
GRJシリーズ
GR3シリーズ
KRMシリーズ
KR3シリーズ
LLAシリーズ
LLLシリーズ
LLMシリーズ
LLRシリーズ
△注意/
使用上の注意

GJMシリーズ 温度補償用 High Q 品番表

(→ ■0.6×0.3mm)

T寸法 最大値	定格 電圧	温度 特性	静電容量	許容差	品番
0.33mm	25Vdc	COG	0.50pF	±0.05pF	GJM0335C1E1R50WB01#
				±0.1pF	GJM0335C1E1R50BB01#
			0.60pF	±0.05pF	GJM0335C1E1R60WB01#
				±0.1pF	GJM0335C1E1R60BB01#
			0.70pF	±0.05pF	GJM0335C1E1R70WB01#
				±0.1pF	GJM0335C1E1R70BB01#
			0.80pF	±0.05pF	GJM0335C1E1R80WB01#
				±0.1pF	GJM0335C1E1R80BB01#
			0.90pF	±0.05pF	GJM0335C1E1R90WB01#
				±0.1pF	GJM0335C1E1R90BB01#
			1.0pF	±0.05pF	GJM0335C1E1R0WB01#
				±0.1pF	GJM0335C1E1R0BB01#
				±0.25pF	GJM0335C1E1R0CB01#
			1.1pF	±0.05pF	GJM0335C1E1R1WB01#
				±0.1pF	GJM0335C1E1R1BB01#
				±0.25pF	GJM0335C1E1R1CB01#
			1.2pF	±0.05pF	GJM0335C1E1R2WB01#
				±0.1pF	GJM0335C1E1R2BB01#
				±0.25pF	GJM0335C1E1R2CB01#
			1.3pF	±0.05pF	GJM0335C1E1R3WB01#
				±0.1pF	GJM0335C1E1R3BB01#
				±0.25pF	GJM0335C1E1R3CB01#
			1.4pF	±0.05pF	GJM0335C1E1R4WB01#
				±0.1pF	GJM0335C1E1R4BB01#
				±0.25pF	GJM0335C1E1R4CB01#
			1.5pF	±0.05pF	GJM0335C1E1R5WB01#
				±0.1pF	GJM0335C1E1R5BB01#
				±0.25pF	GJM0335C1E1R5CB01#
			1.6pF	±0.05pF	GJM0335C1E1R6WB01#
				±0.1pF	GJM0335C1E1R6BB01#
				±0.25pF	GJM0335C1E1R6CB01#
			1.7pF	±0.05pF	GJM0335C1E1R7WB01#
				±0.1pF	GJM0335C1E1R7BB01#
				±0.25pF	GJM0335C1E1R7CB01#
			1.8pF	±0.05pF	GJM0335C1E1R8WB01#
				±0.1pF	GJM0335C1E1R8BB01#
				±0.25pF	GJM0335C1E1R8CB01#
			1.9pF	±0.05pF	GJM0335C1E1R9WB01#
				±0.1pF	GJM0335C1E1R9BB01#
				±0.25pF	GJM0335C1E1R9CB01#
			2.0pF	±0.05pF	GJM0335C1E2R0WB01#
				±0.1pF	GJM0335C1E2R0BB01#
				±0.25pF	GJM0335C1E2R0CB01#
			2.1pF	±0.05pF	GJM0335C1E2R1WB01#
				±0.1pF	GJM0335C1E2R1BB01#
				±0.25pF	GJM0335C1E2R1CB01#
			2.2pF	±0.05pF	GJM0335C1E2R2WB01#
				±0.1pF	GJM0335C1E2R2BB01#
±0.25pF	GJM0335C1E2R2CB01#				
2.3pF	±0.05pF	GJM0335C1E2R3WB01#			
	±0.1pF	GJM0335C1E2R3BB01#			
	±0.25pF	GJM0335C1E2R3CB01#			
2.4pF	±0.05pF	GJM0335C1E2R4WB01#			
	±0.1pF	GJM0335C1E2R4BB01#			

T寸法 最大値	定格 電圧	温度 特性	静電容量	許容差	品番
0.33mm	25Vdc	COG	2.4pF	±0.25pF	GJM0335C1E2R4CB01#
				±0.05pF	GJM0335C1E2R5WB01#
			2.5pF	±0.05pF	GJM0335C1E2R5WB01#
				±0.1pF	GJM0335C1E2R5BB01#
			2.6pF	±0.25pF	GJM0335C1E2R5CB01#
				±0.05pF	GJM0335C1E2R6WB01#
				±0.1pF	GJM0335C1E2R6BB01#
			2.7pF	±0.25pF	GJM0335C1E2R6CB01#
				±0.05pF	GJM0335C1E2R7WB01#
			2.8pF	±0.1pF	GJM0335C1E2R7BB01#
				±0.25pF	GJM0335C1E2R7CB01#
				±0.05pF	GJM0335C1E2R8WB01#
			2.9pF	±0.05pF	GJM0335C1E2R8WB01#
				±0.1pF	GJM0335C1E2R8BB01#
				±0.25pF	GJM0335C1E2R8CB01#
			3.0pF	±0.05pF	GJM0335C1E3R0WB01#
				±0.1pF	GJM0335C1E3R0BB01#
				±0.25pF	GJM0335C1E3R0CB01#
			3.1pF	±0.05pF	GJM0335C1E3R1WB01#
				±0.1pF	GJM0335C1E3R1BB01#
				±0.25pF	GJM0335C1E3R1CB01#
			3.2pF	±0.05pF	GJM0335C1E3R2WB01#
				±0.1pF	GJM0335C1E3R2BB01#
				±0.25pF	GJM0335C1E3R2CB01#
			3.3pF	±0.05pF	GJM0335C1E3R3WB01#
				±0.1pF	GJM0335C1E3R3BB01#
				±0.25pF	GJM0335C1E3R3CB01#
			3.4pF	±0.05pF	GJM0335C1E3R4WB01#
				±0.1pF	GJM0335C1E3R4BB01#
				±0.25pF	GJM0335C1E3R4CB01#
			3.5pF	±0.05pF	GJM0335C1E3R5WB01#
				±0.1pF	GJM0335C1E3R5BB01#
				±0.25pF	GJM0335C1E3R5CB01#
			3.6pF	±0.05pF	GJM0335C1E3R6WB01#
				±0.1pF	GJM0335C1E3R6BB01#
				±0.25pF	GJM0335C1E3R6CB01#
			3.7pF	±0.05pF	GJM0335C1E3R7WB01#
				±0.1pF	GJM0335C1E3R7BB01#
				±0.25pF	GJM0335C1E3R7CB01#
			3.8pF	±0.05pF	GJM0335C1E3R8WB01#
				±0.1pF	GJM0335C1E3R8BB01#
				±0.25pF	GJM0335C1E3R8CB01#
			3.9pF	±0.05pF	GJM0335C1E3R9WB01#
				±0.1pF	GJM0335C1E3R9BB01#
				±0.25pF	GJM0335C1E3R9CB01#
			4.0pF	±0.05pF	GJM0335C1E4R0WB01#
				±0.1pF	GJM0335C1E4R0BB01#
				±0.25pF	GJM0335C1E4R0CB01#
4.1pF	±0.05pF	GJM0335C1E4R1WB01#			
	±0.1pF	GJM0335C1E4R1BB01#			
	±0.25pF	GJM0335C1E4R1CB01#			
4.2pF	±0.05pF	GJM0335C1E4R2WB01#			
	±0.1pF	GJM0335C1E4R2BB01#			

品番 #には包装仕様コードが入ります。

GRMシリーズ
 GJMシリーズ
 GMAシリーズ
 GMDシリーズ
 GQMシリーズ
 GRJシリーズ
 GR3シリーズ
 KRMシリーズ
 KR3シリーズ
 LLAシリーズ
 LLLシリーズ
 LLMシリーズ
 LLRシリーズ
 △注意/
 使用上の注意

GJMシリーズ 温度補償用 High Q 品番表

(→ ■0.6×0.3mm)

T寸法 最大値	定格 電圧	温度 特性	静電容量	許容差	品番
0.33mm	25Vdc	C0G	4.2pF	±0.25pF	GJM0335C1E4R2CB01#
				±0.05pF	GJM0335C1E4R3WB01#
					±0.1pF
			±0.25pF		GJM0335C1E4R3CB01#
			4.4pF	±0.05pF	GJM0335C1E4R4WB01#
				±0.1pF	GJM0335C1E4R4BB01#
				±0.25pF	GJM0335C1E4R4CB01#
			4.5pF	±0.05pF	GJM0335C1E4R5WB01#
				±0.1pF	GJM0335C1E4R5BB01#
				±0.25pF	GJM0335C1E4R5CB01#
			4.6pF	±0.05pF	GJM0335C1E4R6WB01#
				±0.1pF	GJM0335C1E4R6BB01#
				±0.25pF	GJM0335C1E4R6CB01#
			4.7pF	±0.05pF	GJM0335C1E4R7WB01#
				±0.1pF	GJM0335C1E4R7BB01#
				±0.25pF	GJM0335C1E4R7CB01#
			4.8pF	±0.05pF	GJM0335C1E4R8WB01#
				±0.1pF	GJM0335C1E4R8BB01#
				±0.25pF	GJM0335C1E4R8CB01#
			4.9pF	±0.05pF	GJM0335C1E4R9WB01#
				±0.1pF	GJM0335C1E4R9BB01#
				±0.25pF	GJM0335C1E4R9CB01#
			5.0pF	±0.05pF	GJM0335C1E5R0WB01#
				±0.1pF	GJM0335C1E5R0BB01#
				±0.25pF	GJM0335C1E5R0CB01#
			5.1pF	±0.05pF	GJM0335C1E5R1WB01#
				±0.1pF	GJM0335C1E5R1BB01#
				±0.25pF	GJM0335C1E5R1CB01#
				±0.5pF	GJM0335C1E5R1DB01#
			5.2pF	±0.05pF	GJM0335C1E5R2WB01#
				±0.1pF	GJM0335C1E5R2BB01#
				±0.25pF	GJM0335C1E5R2CB01#
				±0.5pF	GJM0335C1E5R2DB01#
			5.3pF	±0.05pF	GJM0335C1E5R3WB01#
				±0.1pF	GJM0335C1E5R3BB01#
				±0.25pF	GJM0335C1E5R3CB01#
				±0.5pF	GJM0335C1E5R3DB01#
			5.4pF	±0.05pF	GJM0335C1E5R4WB01#
				±0.1pF	GJM0335C1E5R4BB01#
				±0.25pF	GJM0335C1E5R4CB01#
				±0.5pF	GJM0335C1E5R4DB01#
			5.5pF	±0.05pF	GJM0335C1E5R5WB01#
				±0.1pF	GJM0335C1E5R5BB01#
				±0.25pF	GJM0335C1E5R5CB01#
				±0.5pF	GJM0335C1E5R5DB01#
			5.6pF	±0.05pF	GJM0335C1E5R6WB01#
				±0.1pF	GJM0335C1E5R6BB01#
				±0.25pF	GJM0335C1E5R6CB01#
±0.5pF	GJM0335C1E5R6DB01#				
5.7pF	±0.05pF	GJM0335C1E5R7WB01#			
	±0.1pF	GJM0335C1E5R7BB01#			
	±0.25pF	GJM0335C1E5R7CB01#			
	±0.5pF	GJM0335C1E5R7DB01#			
5.8pF	±0.05pF	GJM0335C1E5R8WB01#			

T寸法 最大値	定格 電圧	温度 特性	静電容量	許容差	品番
0.33mm	25Vdc	C0G	5.8pF	±0.1pF	GJM0335C1E5R8BB01#
				±0.25pF	GJM0335C1E5R8CB01#
				±0.5pF	GJM0335C1E5R8DB01#
			5.9pF	±0.05pF	GJM0335C1E5R9WB01#
				±0.1pF	GJM0335C1E5R9BB01#
				±0.25pF	GJM0335C1E5R9CB01#
			6.0pF	±0.05pF	GJM0335C1E6R0WB01#
				±0.1pF	GJM0335C1E6R0BB01#
				±0.25pF	GJM0335C1E6R0CB01#
			6.1pF	±0.05pF	GJM0335C1E6R1WB01#
				±0.1pF	GJM0335C1E6R1BB01#
				±0.25pF	GJM0335C1E6R1CB01#
			6.2pF	±0.05pF	GJM0335C1E6R2WB01#
				±0.1pF	GJM0335C1E6R2BB01#
				±0.25pF	GJM0335C1E6R2CB01#
			6.3pF	±0.05pF	GJM0335C1E6R3WB01#
				±0.1pF	GJM0335C1E6R3BB01#
				±0.25pF	GJM0335C1E6R3CB01#
			6.4pF	±0.05pF	GJM0335C1E6R4WB01#
				±0.1pF	GJM0335C1E6R4BB01#
				±0.25pF	GJM0335C1E6R4CB01#
			6.5pF	±0.05pF	GJM0335C1E6R5WB01#
				±0.1pF	GJM0335C1E6R5BB01#
				±0.25pF	GJM0335C1E6R5CB01#
			6.6pF	±0.05pF	GJM0335C1E6R6WB01#
				±0.1pF	GJM0335C1E6R6BB01#
				±0.25pF	GJM0335C1E6R6CB01#
			6.7pF	±0.05pF	GJM0335C1E6R7WB01#
				±0.1pF	GJM0335C1E6R7BB01#
				±0.25pF	GJM0335C1E6R7CB01#
			6.8pF	±0.05pF	GJM0335C1E6R8WB01#
				±0.1pF	GJM0335C1E6R8BB01#
				±0.25pF	GJM0335C1E6R8CB01#
			6.9pF	±0.05pF	GJM0335C1E6R9WB01#
				±0.1pF	GJM0335C1E6R9BB01#
				±0.25pF	GJM0335C1E6R9CB01#
			7.0pF	±0.05pF	GJM0335C1E7R0WB01#
				±0.1pF	GJM0335C1E7R0BB01#
				±0.25pF	GJM0335C1E7R0CB01#
			7.1pF	±0.05pF	GJM0335C1E7R1WB01#
				±0.1pF	GJM0335C1E7R1BB01#
				±0.25pF	GJM0335C1E7R1CB01#

品番 #には包装仕様コードが入ります。

GRMSシリーズ
GJMシリーズ
GMAシリーズ
GMDシリーズ
GQMシリーズ
GRJシリーズ
GR3シリーズ
KRMシリーズ
KR3シリーズ
LLAシリーズ
LLLシリーズ
LLMシリーズ
LLRシリーズ
△注意/
使用上の注意

GJMシリーズ 温度補償用 High Q 品番表

(→ ■0.6×0.3mm)

T寸法 最大値	定格 電圧	温度 特性	静電容量	許容差	品番	
0.33mm	25Vdc	C0G	7.1pF	±0.5pF	GJM0335C1E7R1DB01#	
				7.2pF	±0.05pF	GJM0335C1E7R2WB01#
					±0.1pF	GJM0335C1E7R2BB01#
			±0.25pF		GJM0335C1E7R2CB01#	
			±0.5pF		GJM0335C1E7R2DB01#	
			7.3pF	±0.05pF	GJM0335C1E7R3WB01#	
				±0.1pF	GJM0335C1E7R3BB01#	
				±0.25pF	GJM0335C1E7R3CB01#	
				±0.5pF	GJM0335C1E7R3DB01#	
			7.4pF	±0.05pF	GJM0335C1E7R4WB01#	
				±0.1pF	GJM0335C1E7R4BB01#	
				±0.25pF	GJM0335C1E7R4CB01#	
				±0.5pF	GJM0335C1E7R4DB01#	
			7.5pF	±0.05pF	GJM0335C1E7R5WB01#	
				±0.1pF	GJM0335C1E7R5BB01#	
				±0.25pF	GJM0335C1E7R5CB01#	
				±0.5pF	GJM0335C1E7R5DB01#	
			7.6pF	±0.05pF	GJM0335C1E7R6WB01#	
				±0.1pF	GJM0335C1E7R6BB01#	
				±0.25pF	GJM0335C1E7R6CB01#	
				±0.5pF	GJM0335C1E7R6DB01#	
			7.7pF	±0.05pF	GJM0335C1E7R7WB01#	
				±0.1pF	GJM0335C1E7R7BB01#	
				±0.25pF	GJM0335C1E7R7CB01#	
				±0.5pF	GJM0335C1E7R7DB01#	
			7.8pF	±0.05pF	GJM0335C1E7R8WB01#	
				±0.1pF	GJM0335C1E7R8BB01#	
				±0.25pF	GJM0335C1E7R8CB01#	
				±0.5pF	GJM0335C1E7R8DB01#	
			7.9pF	±0.05pF	GJM0335C1E7R9WB01#	
				±0.1pF	GJM0335C1E7R9BB01#	
				±0.25pF	GJM0335C1E7R9CB01#	
				±0.5pF	GJM0335C1E7R9DB01#	
			8.0pF	±0.05pF	GJM0335C1E8R0WB01#	
				±0.1pF	GJM0335C1E8R0BB01#	
				±0.25pF	GJM0335C1E8R0CB01#	
				±0.5pF	GJM0335C1E8R0DB01#	
			8.1pF	±0.05pF	GJM0335C1E8R1WB01#	
				±0.1pF	GJM0335C1E8R1BB01#	
				±0.25pF	GJM0335C1E8R1CB01#	
				±0.5pF	GJM0335C1E8R1DB01#	
			8.2pF	±0.05pF	GJM0335C1E8R2WB01#	
				±0.1pF	GJM0335C1E8R2BB01#	
				±0.25pF	GJM0335C1E8R2CB01#	
				±0.5pF	GJM0335C1E8R2DB01#	
8.3pF	±0.05pF	GJM0335C1E8R3WB01#				
	±0.1pF	GJM0335C1E8R3BB01#				
	±0.25pF	GJM0335C1E8R3CB01#				
	±0.5pF	GJM0335C1E8R3DB01#				
8.4pF	±0.05pF	GJM0335C1E8R4WB01#				
	±0.1pF	GJM0335C1E8R4BB01#				
	±0.25pF	GJM0335C1E8R4CB01#				
	±0.5pF	GJM0335C1E8R4DB01#				
8.5pF	±0.05pF	GJM0335C1E8R5WB01#				

T寸法 最大値	定格 電圧	温度 特性	静電容量	許容差	品番
0.33mm	25Vdc	C0G	8.5pF	±0.1pF	GJM0335C1E8R5BB01#
				±0.25pF	GJM0335C1E8R5CB01#
				±0.5pF	GJM0335C1E8R5DB01#
			8.6pF	±0.05pF	GJM0335C1E8R6WB01#
				±0.1pF	GJM0335C1E8R6BB01#
				±0.25pF	GJM0335C1E8R6CB01#
				±0.5pF	GJM0335C1E8R6DB01#
			8.7pF	±0.05pF	GJM0335C1E8R7WB01#
				±0.1pF	GJM0335C1E8R7BB01#
				±0.25pF	GJM0335C1E8R7CB01#
				±0.5pF	GJM0335C1E8R7DB01#
			8.8pF	±0.05pF	GJM0335C1E8R8WB01#
				±0.1pF	GJM0335C1E8R8BB01#
				±0.25pF	GJM0335C1E8R8CB01#
				±0.5pF	GJM0335C1E8R8DB01#
			8.9pF	±0.05pF	GJM0335C1E8R9WB01#
				±0.1pF	GJM0335C1E8R9BB01#
				±0.25pF	GJM0335C1E8R9CB01#
				±0.5pF	GJM0335C1E8R9DB01#
			9.0pF	±0.05pF	GJM0335C1E9R0WB01#
				±0.1pF	GJM0335C1E9R0BB01#
				±0.25pF	GJM0335C1E9R0CB01#
				±0.5pF	GJM0335C1E9R0DB01#
			9.1pF	±0.05pF	GJM0335C1E9R1WB01#
				±0.1pF	GJM0335C1E9R1BB01#
				±0.25pF	GJM0335C1E9R1CB01#
				±0.5pF	GJM0335C1E9R1DB01#
			9.2pF	±0.05pF	GJM0335C1E9R2WB01#
				±0.1pF	GJM0335C1E9R2BB01#
				±0.25pF	GJM0335C1E9R2CB01#
				±0.5pF	GJM0335C1E9R2DB01#
			9.3pF	±0.05pF	GJM0335C1E9R3WB01#
				±0.1pF	GJM0335C1E9R3BB01#
				±0.25pF	GJM0335C1E9R3CB01#
				±0.5pF	GJM0335C1E9R3DB01#
			9.4pF	±0.05pF	GJM0335C1E9R4WB01#
				±0.1pF	GJM0335C1E9R4BB01#
				±0.25pF	GJM0335C1E9R4CB01#
				±0.5pF	GJM0335C1E9R4DB01#
			9.5pF	±0.05pF	GJM0335C1E9R5WB01#
				±0.1pF	GJM0335C1E9R5BB01#
				±0.25pF	GJM0335C1E9R5CB01#
				±0.5pF	GJM0335C1E9R5DB01#
			9.6pF	±0.05pF	GJM0335C1E9R6WB01#
				±0.1pF	GJM0335C1E9R6BB01#
±0.25pF	GJM0335C1E9R6CB01#				
±0.5pF	GJM0335C1E9R6DB01#				
9.7pF	±0.05pF	GJM0335C1E9R7WB01#			
	±0.1pF	GJM0335C1E9R7BB01#			
	±0.25pF	GJM0335C1E9R7CB01#			
	±0.5pF	GJM0335C1E9R7DB01#			
9.8pF	±0.05pF	GJM0335C1E9R8WB01#			
	±0.1pF	GJM0335C1E9R8BB01#			
	±0.25pF	GJM0335C1E9R8CB01#			

品番 #には包装仕様コードが入ります。

GRMシリーズ
 GJMシリーズ
 GMAシリーズ
 GMDシリーズ
 GQMシリーズ
 GRUシリーズ
 GR3シリーズ
 KRMシリーズ
 KR3シリーズ
 LLAシリーズ
 LLLシリーズ
 LLMシリーズ
 LLRシリーズ
 △注意/
 使用上の注意

GJMシリーズ 温度補償用 High Q 品番表

(→ ■0.6×0.3mm)

寸法 最大値	定格 電圧	温度 特性	静電容量	許容差	品番
0.33mm	25Vdc	COG	9.8pF	±0.5pF	GJM0335C1E9R8DB01#
				±0.05pF	GJM0335C1E9R9WB01#
			9.9pF	±0.1pF	GJM0335C1E9R9BB01#
				±0.25pF	GJM0335C1E9R9CB01#
				±0.5pF	GJM0335C1E9R9DB01#
			10pF	±2%	GJM0335C1E100GB01#
				±5%	GJM0335C1E100JB01#
			11pF	±2%	GJM0335C1E110GB01#
				±5%	GJM0335C1E110JB01#
			12pF	±2%	GJM0335C1E120GB01#
				±5%	GJM0335C1E120JB01#
			13pF	±2%	GJM0335C1E130GB01#
				±5%	GJM0335C1E130JB01#
			15pF	±2%	GJM0335C1E150GB01#
				±5%	GJM0335C1E150JB01#
			16pF	±2%	GJM0335C1E160GB01#
				±5%	GJM0335C1E160JB01#
			18pF	±2%	GJM0335C1E180GB01#
				±5%	GJM0335C1E180JB01#
			20pF	±2%	GJM0335C1E200GB01#
				±5%	GJM0335C1E200JB01#
			22pF	±2%	GJM0335C1E220GB01#
				±5%	GJM0335C1E220JB01#
			24pF	±2%	GJM0335C1E240GB01#
				±5%	GJM0335C1E240JB01#
			27pF	±2%	GJM0335C1E270GB01#
				±5%	GJM0335C1E270JB01#
			30pF	±2%	GJM0335C1E300GB01#
				±5%	GJM0335C1E300JB01#
			33pF	±2%	GJM0335C1E330GB01#
±5%	GJM0335C1E330JB01#				

■1.0×0.5mm

寸法 最大値	定格 電圧	温度 特性	静電容量	許容差	品番
0.55mm	50Vdc	CK	0.10pF	±0.05pF	GJM1554C1HR10WB01#
				±0.1pF	GJM1554C1HR10BB01#
			0.20pF	±0.05pF	GJM1554C1HR20WB01#
				±0.1pF	GJM1554C1HR20BB01#
			0.30pF	±0.05pF	GJM1554C1HR30WB01#
				±0.1pF	GJM1554C1HR30BB01#
			0.40pF	±0.05pF	GJM1554C1HR40WB01#
				±0.1pF	GJM1554C1HR40BB01#
			0.50pF	±0.05pF	GJM1554C1HR50WB01#
				±0.1pF	GJM1554C1HR50BB01#
			0.60pF	±0.05pF	GJM1554C1HR60WB01#
				±0.1pF	GJM1554C1HR60BB01#
			0.70pF	±0.05pF	GJM1554C1HR70WB01#
				±0.1pF	GJM1554C1HR70BB01#
			0.80pF	±0.05pF	GJM1554C1HR80WB01#
				±0.1pF	GJM1554C1HR80BB01#
			0.90pF	±0.05pF	GJM1554C1HR90WB01#
				±0.1pF	GJM1554C1HR90BB01#

寸法 最大値	定格 電圧	温度 特性	静電容量	許容差	品番
0.55mm	50Vdc	CK	1.0pF	±0.05pF	GJM1554C1H1R0WB01#
				±0.1pF	GJM1554C1H1R0BB01#
				±0.25pF	GJM1554C1H1R0CB01#
			1.1pF	±0.05pF	GJM1554C1H1R1WB01#
				±0.1pF	GJM1554C1H1R1BB01#
				±0.25pF	GJM1554C1H1R1CB01#
			1.2pF	±0.05pF	GJM1554C1H1R2WB01#
				±0.1pF	GJM1554C1H1R2BB01#
				±0.25pF	GJM1554C1H1R2CB01#
			1.3pF	±0.05pF	GJM1554C1H1R3WB01#
				±0.1pF	GJM1554C1H1R3BB01#
				±0.25pF	GJM1554C1H1R3CB01#
			1.4pF	±0.05pF	GJM1554C1H1R4WB01#
				±0.1pF	GJM1554C1H1R4BB01#
				±0.25pF	GJM1554C1H1R4CB01#
			1.5pF	±0.05pF	GJM1554C1H1R5WB01#
				±0.1pF	GJM1554C1H1R5BB01#
				±0.25pF	GJM1554C1H1R5CB01#
			1.6pF	±0.05pF	GJM1554C1H1R6WB01#
				±0.1pF	GJM1554C1H1R6BB01#
				±0.25pF	GJM1554C1H1R6CB01#
			1.7pF	±0.05pF	GJM1554C1H1R7WB01#
				±0.1pF	GJM1554C1H1R7BB01#
				±0.25pF	GJM1554C1H1R7CB01#
			1.8pF	±0.05pF	GJM1554C1H1R8WB01#
				±0.1pF	GJM1554C1H1R8BB01#
				±0.25pF	GJM1554C1H1R8CB01#
			1.9pF	±0.05pF	GJM1554C1H1R9WB01#
				±0.1pF	GJM1554C1H1R9BB01#
				±0.25pF	GJM1554C1H1R9CB01#
		2.0pF	±0.05pF	GJM1554C1H2R0WB01#	
			±0.1pF	GJM1554C1H2R0BB01#	
			±0.25pF	GJM1554C1H2R0CB01#	
		2.1pF	±0.05pF	GJM1553C1H2R1WB01#	
			±0.1pF	GJM1553C1H2R1BB01#	
			±0.25pF	GJM1553C1H2R1CB01#	
		2.2pF	±0.05pF	GJM1553C1H2R2WB01#	
			±0.1pF	GJM1553C1H2R2BB01#	
			±0.25pF	GJM1553C1H2R2CB01#	
		2.3pF	±0.05pF	GJM1553C1H2R3WB01#	
			±0.1pF	GJM1553C1H2R3BB01#	
			±0.25pF	GJM1553C1H2R3CB01#	
		2.4pF	±0.05pF	GJM1553C1H2R4WB01#	
			±0.1pF	GJM1553C1H2R4BB01#	
			±0.25pF	GJM1553C1H2R4CB01#	
		2.5pF	±0.05pF	GJM1553C1H2R5WB01#	
			±0.1pF	GJM1553C1H2R5BB01#	
			±0.25pF	GJM1553C1H2R5CB01#	
		2.6pF	±0.05pF	GJM1553C1H2R6WB01#	
			±0.1pF	GJM1553C1H2R6BB01#	
±0.25pF	GJM1553C1H2R6CB01#				
2.7pF	±0.05pF	GJM1553C1H2R7WB01#			
	±0.1pF	GJM1553C1H2R7BB01#			
	±0.25pF	GJM1553C1H2R7CB01#			
CJ	2.1pF	±0.05pF	GJM1553C1H2R1WB01#		
		±0.1pF	GJM1553C1H2R1BB01#		
		±0.25pF	GJM1553C1H2R1CB01#		

品番 #には包装仕様コードが入ります。

GRMSシリーズ
GJMシリーズ
GMAシリーズ
GMDシリーズ
GQMシリーズ
GRJシリーズ
GR3シリーズ
KRMシリーズ
KR3シリーズ
LLAシリーズ
LLLシリーズ
LLMシリーズ
LLRシリーズ
△注意/
使用上の注意

GJMシリーズ 温度補償用 High Q 品番表

(→ ■ 1.0×0.5mm)

T寸法 最大値	定格 電圧	温度 特性	静電容量	許容差	品番
0.55mm	50Vdc	CJ	2.8pF	±0.05pF	GJM1553C1H2R8WB01#
				±0.1pF	GJM1553C1H2R8BB01#
				±0.25pF	GJM1553C1H2R8CB01#
			2.9pF	±0.05pF	GJM1553C1H2R9WB01#
				±0.1pF	GJM1553C1H2R9BB01#
				±0.25pF	GJM1553C1H2R9CB01#
			3.0pF	±0.05pF	GJM1553C1H3R0WB01#
				±0.1pF	GJM1553C1H3R0BB01#
				±0.25pF	GJM1553C1H3R0CB01#
			3.1pF	±0.05pF	GJM1553C1H3R1WB01#
				±0.1pF	GJM1553C1H3R1BB01#
				±0.25pF	GJM1553C1H3R1CB01#
			3.2pF	±0.05pF	GJM1553C1H3R2WB01#
				±0.1pF	GJM1553C1H3R2BB01#
				±0.25pF	GJM1553C1H3R2CB01#
			3.3pF	±0.05pF	GJM1553C1H3R3WB01#
				±0.1pF	GJM1553C1H3R3BB01#
				±0.25pF	GJM1553C1H3R3CB01#
			3.4pF	±0.05pF	GJM1553C1H3R4WB01#
				±0.1pF	GJM1553C1H3R4BB01#
				±0.25pF	GJM1553C1H3R4CB01#
			3.5pF	±0.05pF	GJM1553C1H3R5WB01#
				±0.1pF	GJM1553C1H3R5BB01#
				±0.25pF	GJM1553C1H3R5CB01#
			3.6pF	±0.05pF	GJM1553C1H3R6WB01#
				±0.1pF	GJM1553C1H3R6BB01#
				±0.25pF	GJM1553C1H3R6CB01#
			3.7pF	±0.05pF	GJM1553C1H3R7WB01#
				±0.1pF	GJM1553C1H3R7BB01#
				±0.25pF	GJM1553C1H3R7CB01#
			3.8pF	±0.05pF	GJM1553C1H3R8WB01#
				±0.1pF	GJM1553C1H3R8BB01#
				±0.25pF	GJM1553C1H3R8CB01#
			3.9pF	±0.05pF	GJM1553C1H3R9WB01#
				±0.1pF	GJM1553C1H3R9BB01#
				±0.25pF	GJM1553C1H3R9CB01#
		CH	4.0pF	±0.05pF	GJM1552C1H4R0WB01#
				±0.1pF	GJM1552C1H4R0BB01#
				±0.25pF	GJM1552C1H4R0CB01#
			4.1pF	±0.05pF	GJM1552C1H4R1WB01#
				±0.1pF	GJM1552C1H4R1BB01#
				±0.25pF	GJM1552C1H4R1CB01#
			4.2pF	±0.05pF	GJM1552C1H4R2WB01#
				±0.1pF	GJM1552C1H4R2BB01#
				±0.25pF	GJM1552C1H4R2CB01#
			4.3pF	±0.05pF	GJM1552C1H4R3WB01#
				±0.1pF	GJM1552C1H4R3BB01#
				±0.25pF	GJM1552C1H4R3CB01#
4.4pF	±0.05pF		GJM1552C1H4R4WB01#		
	±0.1pF		GJM1552C1H4R4BB01#		
	±0.25pF		GJM1552C1H4R4CB01#		
4.5pF	±0.05pF		GJM1552C1H4R5WB01#		
	±0.1pF		GJM1552C1H4R5BB01#		
	±0.25pF		GJM1552C1H4R5CB01#		

T寸法 最大値	定格 電圧	温度 特性	静電容量	許容差	品番
0.55mm	50Vdc	CH	4.6pF	±0.05pF	GJM1552C1H4R6WB01#
				±0.1pF	GJM1552C1H4R6BB01#
				±0.25pF	GJM1552C1H4R6CB01#
			4.7pF	±0.05pF	GJM1552C1H4R7WB01#
				±0.1pF	GJM1552C1H4R7BB01#
				±0.25pF	GJM1552C1H4R7CB01#
			4.8pF	±0.05pF	GJM1552C1H4R8WB01#
				±0.1pF	GJM1552C1H4R8BB01#
				±0.25pF	GJM1552C1H4R8CB01#
			4.9pF	±0.05pF	GJM1552C1H4R9WB01#
				±0.1pF	GJM1552C1H4R9BB01#
				±0.25pF	GJM1552C1H4R9CB01#
			5.0pF	±0.05pF	GJM1552C1H5R0WB01#
				±0.1pF	GJM1552C1H5R0BB01#
				±0.25pF	GJM1552C1H5R0CB01#
			5.1pF	±0.05pF	GJM1552C1H5R1WB01#
				±0.1pF	GJM1552C1H5R1BB01#
				±0.25pF	GJM1552C1H5R1CB01#
			5.2pF	±0.05pF	GJM1552C1H5R2WB01#
				±0.1pF	GJM1552C1H5R2BB01#
				±0.25pF	GJM1552C1H5R2CB01#
			5.3pF	±0.05pF	GJM1552C1H5R3WB01#
				±0.1pF	GJM1552C1H5R3BB01#
				±0.25pF	GJM1552C1H5R3CB01#
			5.4pF	±0.05pF	GJM1552C1H5R4WB01#
				±0.1pF	GJM1552C1H5R4BB01#
				±0.25pF	GJM1552C1H5R4CB01#
			5.5pF	±0.05pF	GJM1552C1H5R5WB01#
				±0.1pF	GJM1552C1H5R5BB01#
				±0.25pF	GJM1552C1H5R5CB01#
			5.6pF	±0.05pF	GJM1552C1H5R6WB01#
				±0.1pF	GJM1552C1H5R6BB01#
				±0.25pF	GJM1552C1H5R6CB01#
			5.7pF	±0.05pF	GJM1552C1H5R7WB01#
				±0.1pF	GJM1552C1H5R7BB01#
				±0.25pF	GJM1552C1H5R7CB01#
			5.8pF	±0.05pF	GJM1552C1H5R8WB01#
				±0.1pF	GJM1552C1H5R8BB01#
				±0.25pF	GJM1552C1H5R8CB01#
			5.9pF	±0.05pF	GJM1552C1H5R9WB01#
				±0.1pF	GJM1552C1H5R9BB01#
				±0.25pF	GJM1552C1H5R9CB01#
			6.0pF	±0.05pF	GJM1552C1H6R0WB01#
				±0.1pF	GJM1552C1H6R0BB01#
				±0.25pF	GJM1552C1H6R0CB01#

品番 #には包装仕様コードが入ります。

GRMシリーズ
 GJMシリーズ
 GMAシリーズ
 GMDシリーズ
 GQMシリーズ
 GRUシリーズ
 GR3シリーズ
 KRMシリーズ
 KR3シリーズ
 LLAシリーズ
 LLシリーズ
 LLMシリーズ
 LLRシリーズ
 △注意/
 使用上の注意

GJMシリーズ 温度補償用 High Q 品番表

(→ ■ 1.0×0.5mm)

T寸法 最大値	定格 電圧	温度 特性	静電容量	許容差	品番	
0.55mm	50Vdc	CH	6.0pF	±0.5pF	GJM1552C1H6R0DB01#	
				±0.05pF	GJM1552C1H6R1WB01#	
					±0.1pF	GJM1552C1H6R1BB01#
			±0.25pF		GJM1552C1H6R1CB01#	
			±0.5pF	GJM1552C1H6R1DB01#		
				6.2pF	±0.05pF	GJM1552C1H6R2WB01#
					±0.1pF	GJM1552C1H6R2BB01#
			±0.25pF		GJM1552C1H6R2CB01#	
			±0.5pF	GJM1552C1H6R2DB01#		
			6.3pF	±0.05pF	GJM1552C1H6R3WB01#	
				±0.1pF	GJM1552C1H6R3BB01#	
				±0.25pF	GJM1552C1H6R3CB01#	
			±0.5pF	GJM1552C1H6R3DB01#		
			6.4pF	±0.05pF	GJM1552C1H6R4WB01#	
				±0.1pF	GJM1552C1H6R4BB01#	
				±0.25pF	GJM1552C1H6R4CB01#	
			±0.5pF	GJM1552C1H6R4DB01#		
			6.5pF	±0.05pF	GJM1552C1H6R5WB01#	
				±0.1pF	GJM1552C1H6R5BB01#	
				±0.25pF	GJM1552C1H6R5CB01#	
			±0.5pF	GJM1552C1H6R5DB01#		
			6.6pF	±0.05pF	GJM1552C1H6R6WB01#	
				±0.1pF	GJM1552C1H6R6BB01#	
				±0.25pF	GJM1552C1H6R6CB01#	
			±0.5pF	GJM1552C1H6R6DB01#		
			6.7pF	±0.05pF	GJM1552C1H6R7WB01#	
				±0.1pF	GJM1552C1H6R7BB01#	
				±0.25pF	GJM1552C1H6R7CB01#	
			±0.5pF	GJM1552C1H6R7DB01#		
			6.8pF	±0.05pF	GJM1552C1H6R8WB01#	
				±0.1pF	GJM1552C1H6R8BB01#	
				±0.25pF	GJM1552C1H6R8CB01#	
			±0.5pF	GJM1552C1H6R8DB01#		
			6.9pF	±0.05pF	GJM1552C1H6R9WB01#	
				±0.1pF	GJM1552C1H6R9BB01#	
				±0.25pF	GJM1552C1H6R9CB01#	
			±0.5pF	GJM1552C1H6R9DB01#		
			7.0pF	±0.05pF	GJM1552C1H7R0WB01#	
				±0.1pF	GJM1552C1H7R0BB01#	
				±0.25pF	GJM1552C1H7R0CB01#	
			±0.5pF	GJM1552C1H7R0DB01#		
			7.1pF	±0.05pF	GJM1552C1H7R1WB01#	
				±0.1pF	GJM1552C1H7R1BB01#	
				±0.25pF	GJM1552C1H7R1CB01#	
			±0.5pF	GJM1552C1H7R1DB01#		
			7.2pF	±0.05pF	GJM1552C1H7R2WB01#	
				±0.1pF	GJM1552C1H7R2BB01#	
				±0.25pF	GJM1552C1H7R2CB01#	
±0.5pF	GJM1552C1H7R2DB01#					
7.3pF	±0.05pF	GJM1552C1H7R3WB01#				
	±0.1pF	GJM1552C1H7R3BB01#				
	±0.25pF	GJM1552C1H7R3CB01#				
±0.5pF	GJM1552C1H7R3DB01#					
7.4pF	±0.05pF	GJM1552C1H7R4WB01#				

T寸法 最大値	定格 電圧	温度 特性	静電容量	許容差	品番
0.55mm	50Vdc	CH	7.4pF	±0.1pF	GJM1552C1H7R4BB01#
				±0.25pF	GJM1552C1H7R4CB01#
				±0.5pF	GJM1552C1H7R4DB01#
			7.5pF	±0.05pF	GJM1552C1H7R5WB01#
				±0.1pF	GJM1552C1H7R5BB01#
				±0.25pF	GJM1552C1H7R5CB01#
			±0.5pF	GJM1552C1H7R5DB01#	
			7.6pF	±0.05pF	GJM1552C1H7R6WB01#
				±0.1pF	GJM1552C1H7R6BB01#
				±0.25pF	GJM1552C1H7R6CB01#
			±0.5pF	GJM1552C1H7R6DB01#	
			7.7pF	±0.05pF	GJM1552C1H7R7WB01#
				±0.1pF	GJM1552C1H7R7BB01#
				±0.25pF	GJM1552C1H7R7CB01#
			±0.5pF	GJM1552C1H7R7DB01#	
			7.8pF	±0.05pF	GJM1552C1H7R8WB01#
				±0.1pF	GJM1552C1H7R8BB01#
				±0.25pF	GJM1552C1H7R8CB01#
			±0.5pF	GJM1552C1H7R8DB01#	
			7.9pF	±0.05pF	GJM1552C1H7R9WB01#
				±0.1pF	GJM1552C1H7R9BB01#
				±0.25pF	GJM1552C1H7R9CB01#
			±0.5pF	GJM1552C1H7R9DB01#	
			8.0pF	±0.05pF	GJM1552C1H8R0WB01#
				±0.1pF	GJM1552C1H8R0BB01#
				±0.25pF	GJM1552C1H8R0CB01#
			±0.5pF	GJM1552C1H8R0DB01#	
			8.1pF	±0.05pF	GJM1552C1H8R1WB01#
				±0.1pF	GJM1552C1H8R1BB01#
				±0.25pF	GJM1552C1H8R1CB01#
			±0.5pF	GJM1552C1H8R1DB01#	
			8.2pF	±0.05pF	GJM1552C1H8R2WB01#
				±0.1pF	GJM1552C1H8R2BB01#
				±0.25pF	GJM1552C1H8R2CB01#
			±0.5pF	GJM1552C1H8R2DB01#	
			8.3pF	±0.05pF	GJM1552C1H8R3WB01#
				±0.1pF	GJM1552C1H8R3BB01#
				±0.25pF	GJM1552C1H8R3CB01#
			±0.5pF	GJM1552C1H8R3DB01#	
			8.4pF	±0.05pF	GJM1552C1H8R4WB01#
				±0.1pF	GJM1552C1H8R4BB01#
				±0.25pF	GJM1552C1H8R4CB01#
			±0.5pF	GJM1552C1H8R4DB01#	
			8.5pF	±0.05pF	GJM1552C1H8R5WB01#
				±0.1pF	GJM1552C1H8R5BB01#
				±0.25pF	GJM1552C1H8R5CB01#
			±0.5pF	GJM1552C1H8R5DB01#	
			8.6pF	±0.05pF	GJM1552C1H8R6WB01#
±0.1pF	GJM1552C1H8R6BB01#				
±0.25pF	GJM1552C1H8R6CB01#				
±0.5pF	GJM1552C1H8R6DB01#				
8.7pF	±0.05pF	GJM1552C1H8R7WB01#			
	±0.1pF	GJM1552C1H8R7BB01#			
	±0.25pF	GJM1552C1H8R7CB01#			

品番 #には包装仕様コードが入ります。

GRMSシリーズ
GJMシリーズ
GMAシリーズ
GMDシリーズ
GQMシリーズ
GRJシリーズ
GR3シリーズ
KRMシリーズ
KR3シリーズ
LLAシリーズ
LLLシリーズ
LLMシリーズ
LLRシリーズ
△注意/
使用上の注意

GJMシリーズ 温度補償用 High Q 品番表

(→ ■ 1.0×0.5mm)

T寸法 最大値	定格 電圧	温度 特性	静電容量	許容差	品番	
0.55mm	50Vdc	CH	8.7pF	±0.5pF	GJM1552C1H8R7DB01#	
				8.8pF	±0.05pF	GJM1552C1H8R8WB01#
					±0.1pF	GJM1552C1H8R8BB01#
					±0.25pF	GJM1552C1H8R8CB01#
			±0.5pF		GJM1552C1H8R8DB01#	
			8.9pF	±0.05pF	GJM1552C1H8R9WB01#	
				±0.1pF	GJM1552C1H8R9BB01#	
				±0.25pF	GJM1552C1H8R9CB01#	
				±0.5pF	GJM1552C1H8R9DB01#	
			9.0pF	±0.05pF	GJM1552C1H9R0WB01#	
				±0.1pF	GJM1552C1H9R0BB01#	
				±0.25pF	GJM1552C1H9R0CB01#	
				±0.5pF	GJM1552C1H9R0DB01#	
			9.1pF	±0.05pF	GJM1552C1H9R1WB01#	
				±0.1pF	GJM1552C1H9R1BB01#	
				±0.25pF	GJM1552C1H9R1CB01#	
				±0.5pF	GJM1552C1H9R1DB01#	
			9.2pF	±0.05pF	GJM1552C1H9R2WB01#	
				±0.1pF	GJM1552C1H9R2BB01#	
				±0.25pF	GJM1552C1H9R2CB01#	
				±0.5pF	GJM1552C1H9R2DB01#	
			9.3pF	±0.05pF	GJM1552C1H9R3WB01#	
				±0.1pF	GJM1552C1H9R3BB01#	
				±0.25pF	GJM1552C1H9R3CB01#	
				±0.5pF	GJM1552C1H9R3DB01#	
			9.4pF	±0.05pF	GJM1552C1H9R4WB01#	
				±0.1pF	GJM1552C1H9R4BB01#	
				±0.25pF	GJM1552C1H9R4CB01#	
				±0.5pF	GJM1552C1H9R4DB01#	
			9.5pF	±0.05pF	GJM1552C1H9R5WB01#	
				±0.1pF	GJM1552C1H9R5BB01#	
				±0.25pF	GJM1552C1H9R5CB01#	
				±0.5pF	GJM1552C1H9R5DB01#	
			9.6pF	±0.05pF	GJM1552C1H9R6WB01#	
				±0.1pF	GJM1552C1H9R6BB01#	
				±0.25pF	GJM1552C1H9R6CB01#	
				±0.5pF	GJM1552C1H9R6DB01#	
			9.7pF	±0.05pF	GJM1552C1H9R7WB01#	
				±0.1pF	GJM1552C1H9R7BB01#	
				±0.25pF	GJM1552C1H9R7CB01#	
				±0.5pF	GJM1552C1H9R7DB01#	
			9.8pF	±0.05pF	GJM1552C1H9R8WB01#	
				±0.1pF	GJM1552C1H9R8BB01#	
				±0.25pF	GJM1552C1H9R8CB01#	
				±0.5pF	GJM1552C1H9R8DB01#	
			9.9pF	±0.05pF	GJM1552C1H9R9WB01#	
				±0.1pF	GJM1552C1H9R9BB01#	
				±0.25pF	GJM1552C1H9R9CB01#	
±0.5pF	GJM1552C1H9R9DB01#					
10pF	±2%	GJM1552C1H100GB01#				
	±5%	GJM1552C1H100JB01#				
11pF	±2%	GJM1552C1H110GB01#				
	±5%	GJM1552C1H110JB01#				
12pF	±2%	GJM1552C1H120GB01#				

T寸法 最大値	定格 電圧	温度 特性	静電容量	許容差	品番
0.55mm	50Vdc	CH	12pF	±5%	GJM1552C1H120JB01#
				±2%	GJM1552C1H130GB01#
			13pF	±5%	GJM1552C1H130JB01#
				±2%	GJM1552C1H150GB01#
			15pF	±5%	GJM1552C1H150JB01#
				±2%	GJM1552C1H160GB01#
			16pF	±5%	GJM1552C1H160JB01#
				±2%	GJM1552C1H180GB01#
			18pF	±5%	GJM1552C1H180JB01#
				±2%	GJM1552C1H200GB01#
			20pF	±5%	GJM1552C1H200JB01#
				±1%	GJM1552C1H220FB01#
			22pF	±2%	GJM1552C1H220GB01#
				±5%	GJM1552C1H220JB01#
				±1%	GJM1552C1H240FB01#
			24pF	±2%	GJM1552C1H240GB01#
				±5%	GJM1552C1H240JB01#
				±1%	GJM1552C1H270FB01#
			27pF	±2%	GJM1552C1H270GB01#
				±5%	GJM1552C1H270JB01#
				±1%	GJM1552C1H300FB01#
			30pF	±2%	GJM1552C1H300GB01#
				±5%	GJM1552C1H300JB01#
				±1%	GJM1552C1H330FB01#
		33pF	±2%	GJM1552C1H330GB01#	
			±5%	GJM1552C1H330JB01#	
			±1%	GJM1552C1H360FB01#	
		36pF	±2%	GJM1552C1H360GB01#	
			±5%	GJM1552C1H360JB01#	
			±1%	GJM1552C1H390FB01#	
		39pF	±2%	GJM1552C1H390GB01#	
			±5%	GJM1552C1H390JB01#	
			±1%	GJM1552C1H430FB01#	
		43pF	±2%	GJM1552C1H430GB01#	
			±5%	GJM1552C1H430JB01#	
			±1%	GJM1552C1H470FB01#	
		47pF	±2%	GJM1552C1H470GB01#	
			±5%	GJM1552C1H470JB01#	
			COG	0.10pF	±0.05pF
		±0.1pF			GJM1555C1HR10BB01#
		0.20pF		±0.05pF	GJM1555C1HR20WB01#
				±0.1pF	GJM1555C1HR20BB01#
		0.30pF		±0.05pF	GJM1555C1HR30WB01#
				±0.1pF	GJM1555C1HR30BB01#
		0.40pF		±0.05pF	GJM1555C1HR40WB01#
				±0.1pF	GJM1555C1HR40BB01#
		0.50pF		±0.05pF	GJM1555C1HR50WB01#
				±0.1pF	GJM1555C1HR50BB01#
0.60pF	±0.05pF	GJM1555C1HR60WB01#			
	±0.1pF	GJM1555C1HR60BB01#			
0.70pF	±0.05pF	GJM1555C1HR70WB01#			
	±0.1pF	GJM1555C1HR70BB01#			
0.80pF	±0.05pF	GJM1555C1HR80WB01#			
	±0.1pF	GJM1555C1HR80BB01#			

品番 #には包装仕様コードが入ります。

GRMシリーズ
 GJMシリーズ
 GMAシリーズ
 GMDシリーズ
 GQMシリーズ
 GRJシリーズ
 GR3シリーズ
 KRMシリーズ
 KR3シリーズ
 LLAシリーズ
 LLLシリーズ
 LLMシリーズ
 LLRシリーズ
 △注意/
 使用上の注意

GJMシリーズ 温度補償用 High Q 品番表

(→ ■ 1.0×0.5mm)

T寸法 最大値	定格 電圧	温度 特性	静電容量	許容差	品番
0.55mm	50Vdc	COG	0.90pF	±0.05pF	GJM1555C1HR90WB01#
				±0.1pF	GJM1555C1HR90BB01#
			1.0pF	±0.05pF	GJM1555C1H1R0WB01#
				±0.1pF	GJM1555C1H1R0BB01#
				±0.25pF	GJM1555C1H1R0CB01#
			1.1pF	±0.05pF	GJM1555C1H1R1WB01#
				±0.1pF	GJM1555C1H1R1BB01#
				±0.25pF	GJM1555C1H1R1CB01#
			1.2pF	±0.05pF	GJM1555C1H1R2WB01#
				±0.1pF	GJM1555C1H1R2BB01#
				±0.25pF	GJM1555C1H1R2CB01#
			1.3pF	±0.05pF	GJM1555C1H1R3WB01#
				±0.1pF	GJM1555C1H1R3BB01#
				±0.25pF	GJM1555C1H1R3CB01#
			1.4pF	±0.05pF	GJM1555C1H1R4WB01#
				±0.1pF	GJM1555C1H1R4BB01#
				±0.25pF	GJM1555C1H1R4CB01#
			1.5pF	±0.05pF	GJM1555C1H1R5WB01#
				±0.1pF	GJM1555C1H1R5BB01#
				±0.25pF	GJM1555C1H1R5CB01#
			1.6pF	±0.05pF	GJM1555C1H1R6WB01#
				±0.1pF	GJM1555C1H1R6BB01#
				±0.25pF	GJM1555C1H1R6CB01#
			1.7pF	±0.05pF	GJM1555C1H1R7WB01#
				±0.1pF	GJM1555C1H1R7BB01#
				±0.25pF	GJM1555C1H1R7CB01#
			1.8pF	±0.05pF	GJM1555C1H1R8WB01#
				±0.1pF	GJM1555C1H1R8BB01#
				±0.25pF	GJM1555C1H1R8CB01#
			1.9pF	±0.05pF	GJM1555C1H1R9WB01#
				±0.1pF	GJM1555C1H1R9BB01#
				±0.25pF	GJM1555C1H1R9CB01#
			2.0pF	±0.05pF	GJM1555C1H2R0WB01#
				±0.1pF	GJM1555C1H2R0BB01#
				±0.25pF	GJM1555C1H2R0CB01#
			2.1pF	±0.05pF	GJM1555C1H2R1WB01#
				±0.1pF	GJM1555C1H2R1BB01#
				±0.25pF	GJM1555C1H2R1CB01#
			2.2pF	±0.05pF	GJM1555C1H2R2WB01#
				±0.1pF	GJM1555C1H2R2BB01#
				±0.25pF	GJM1555C1H2R2CB01#
			2.3pF	±0.05pF	GJM1555C1H2R3WB01#
±0.1pF	GJM1555C1H2R3BB01#				
±0.25pF	GJM1555C1H2R3CB01#				
2.4pF	±0.05pF	GJM1555C1H2R4WB01#			
	±0.1pF	GJM1555C1H2R4BB01#			
	±0.25pF	GJM1555C1H2R4CB01#			
2.5pF	±0.05pF	GJM1555C1H2R5WB01#			
	±0.1pF	GJM1555C1H2R5BB01#			
	±0.25pF	GJM1555C1H2R5CB01#			
2.6pF	±0.05pF	GJM1555C1H2R6WB01#			
	±0.1pF	GJM1555C1H2R6BB01#			
	±0.25pF	GJM1555C1H2R6CB01#			
2.7pF	±0.05pF	GJM1555C1H2R7WB01#			

T寸法 最大値	定格 電圧	温度 特性	静電容量	許容差	品番
0.55mm	50Vdc	COG	2.7pF	±0.1pF	GJM1555C1H2R7BB01#
				±0.25pF	GJM1555C1H2R7CB01#
			2.8pF	±0.05pF	GJM1555C1H2R8WB01#
				±0.1pF	GJM1555C1H2R8BB01#
				±0.25pF	GJM1555C1H2R8CB01#
			2.9pF	±0.05pF	GJM1555C1H2R9WB01#
				±0.1pF	GJM1555C1H2R9BB01#
				±0.25pF	GJM1555C1H2R9CB01#
			3.0pF	±0.05pF	GJM1555C1H3R0WB01#
				±0.1pF	GJM1555C1H3R0BB01#
				±0.25pF	GJM1555C1H3R0CB01#
			3.1pF	±0.05pF	GJM1555C1H3R1WB01#
				±0.1pF	GJM1555C1H3R1BB01#
				±0.25pF	GJM1555C1H3R1CB01#
			3.2pF	±0.05pF	GJM1555C1H3R2WB01#
				±0.1pF	GJM1555C1H3R2BB01#
				±0.25pF	GJM1555C1H3R2CB01#
			3.3pF	±0.05pF	GJM1555C1H3R3WB01#
				±0.1pF	GJM1555C1H3R3BB01#
				±0.25pF	GJM1555C1H3R3CB01#
			3.4pF	±0.05pF	GJM1555C1H3R4WB01#
				±0.1pF	GJM1555C1H3R4BB01#
				±0.25pF	GJM1555C1H3R4CB01#
			3.5pF	±0.05pF	GJM1555C1H3R5WB01#
				±0.1pF	GJM1555C1H3R5BB01#
				±0.25pF	GJM1555C1H3R5CB01#
			3.6pF	±0.05pF	GJM1555C1H3R6WB01#
				±0.1pF	GJM1555C1H3R6BB01#
				±0.25pF	GJM1555C1H3R6CB01#
			3.7pF	±0.05pF	GJM1555C1H3R7WB01#
				±0.1pF	GJM1555C1H3R7BB01#
				±0.25pF	GJM1555C1H3R7CB01#
			3.8pF	±0.05pF	GJM1555C1H3R8WB01#
				±0.1pF	GJM1555C1H3R8BB01#
				±0.25pF	GJM1555C1H3R8CB01#
			3.9pF	±0.05pF	GJM1555C1H3R9WB01#
				±0.1pF	GJM1555C1H3R9BB01#
				±0.25pF	GJM1555C1H3R9CB01#
			4.0pF	±0.05pF	GJM1555C1H4R0WB01#
				±0.1pF	GJM1555C1H4R0BB01#
				±0.25pF	GJM1555C1H4R0CB01#
			4.1pF	±0.05pF	GJM1555C1H4R1WB01#
±0.1pF	GJM1555C1H4R1BB01#				
±0.25pF	GJM1555C1H4R1CB01#				
4.2pF	±0.05pF	GJM1555C1H4R2WB01#			
	±0.1pF	GJM1555C1H4R2BB01#			
	±0.25pF	GJM1555C1H4R2CB01#			
4.3pF	±0.05pF	GJM1555C1H4R3WB01#			
	±0.1pF	GJM1555C1H4R3BB01#			
	±0.25pF	GJM1555C1H4R3CB01#			
4.4pF	±0.05pF	GJM1555C1H4R4WB01#			
	±0.1pF	GJM1555C1H4R4BB01#			
	±0.25pF	GJM1555C1H4R4CB01#			
4.5pF	±0.05pF	GJM1555C1H4R5WB01#			

品番 #には包装仕様コードが入ります。

GRMSシリーズ
GJMシリーズ
GMAシリーズ
GMDシリーズ
GQMシリーズ
GRJシリーズ
GR3シリーズ
KRMシリーズ
KR3シリーズ
LLAシリーズ
LLLシリーズ
LLMシリーズ
LLRシリーズ
△注意/
使用上の注意

GJMシリーズ 温度補償用 High Q 品番表

(→ ■ 1.0×0.5mm)

T寸法 最大値	定格 電圧	温度 特性	静電容量	許容差	品番
0.55mm	50Vdc	COG	4.5pF	±0.1pF	GJM1555C1H4R5BB01#
				±0.25pF	GJM1555C1H4R5CB01#
			4.6pF	±0.05pF	GJM1555C1H4R6WB01#
				±0.1pF	GJM1555C1H4R6BB01#
			4.7pF	±0.05pF	GJM1555C1H4R7WB01#
				±0.1pF	GJM1555C1H4R7BB01#
			4.8pF	±0.25pF	GJM1555C1H4R7CB01#
				±0.05pF	GJM1555C1H4R8WB01#
				±0.1pF	GJM1555C1H4R8BB01#
			4.9pF	±0.25pF	GJM1555C1H4R8CB01#
				±0.05pF	GJM1555C1H4R9WB01#
				±0.1pF	GJM1555C1H4R9BB01#
			5.0pF	±0.25pF	GJM1555C1H4R9CB01#
				±0.05pF	GJM1555C1H5R0WB01#
				±0.1pF	GJM1555C1H5R0BB01#
			5.1pF	±0.25pF	GJM1555C1H5R0CB01#
				±0.05pF	GJM1555C1H5R1WB01#
				±0.1pF	GJM1555C1H5R1BB01#
			5.2pF	±0.25pF	GJM1555C1H5R1CB01#
				±0.05pF	GJM1555C1H5R2WB01#
				±0.1pF	GJM1555C1H5R2BB01#
			5.3pF	±0.25pF	GJM1555C1H5R2CB01#
				±0.05pF	GJM1555C1H5R3WB01#
				±0.1pF	GJM1555C1H5R3BB01#
			5.4pF	±0.25pF	GJM1555C1H5R3CB01#
				±0.05pF	GJM1555C1H5R4WB01#
				±0.1pF	GJM1555C1H5R4BB01#
			5.5pF	±0.25pF	GJM1555C1H5R4CB01#
				±0.05pF	GJM1555C1H5R5WB01#
				±0.1pF	GJM1555C1H5R5BB01#
			5.6pF	±0.25pF	GJM1555C1H5R5CB01#
				±0.05pF	GJM1555C1H5R6WB01#
				±0.1pF	GJM1555C1H5R6BB01#
			5.7pF	±0.25pF	GJM1555C1H5R6CB01#
				±0.05pF	GJM1555C1H5R7WB01#
				±0.1pF	GJM1555C1H5R7BB01#
			5.8pF	±0.25pF	GJM1555C1H5R7CB01#
				±0.05pF	GJM1555C1H5R8WB01#
				±0.1pF	GJM1555C1H5R8BB01#
			5.9pF	±0.25pF	GJM1555C1H5R8CB01#
				±0.05pF	GJM1555C1H5R9WB01#
				±0.1pF	GJM1555C1H5R9BB01#
			6.0pF	±0.25pF	GJM1555C1H5R9CB01#
				±0.05pF	GJM1555C1H6R0WB01#
				±0.1pF	GJM1555C1H6R0BB01#

T寸法 最大値	定格 電圧	温度 特性	静電容量	許容差	品番
0.55mm	50Vdc	COG	6.0pF	±0.1pF	GJM1555C1H6R0BB01#
				±0.25pF	GJM1555C1H6R0CB01#
				±0.5pF	GJM1555C1H6R0DB01#
			6.1pF	±0.05pF	GJM1555C1H6R1WB01#
				±0.1pF	GJM1555C1H6R1BB01#
				±0.25pF	GJM1555C1H6R1CB01#
			6.2pF	±0.5pF	GJM1555C1H6R1DB01#
				±0.05pF	GJM1555C1H6R2WB01#
				±0.1pF	GJM1555C1H6R2BB01#
			6.3pF	±0.25pF	GJM1555C1H6R2CB01#
				±0.05pF	GJM1555C1H6R3WB01#
				±0.1pF	GJM1555C1H6R3BB01#
			6.4pF	±0.25pF	GJM1555C1H6R3CB01#
				±0.05pF	GJM1555C1H6R3DB01#
				±0.5pF	GJM1555C1H6R4WB01#
			6.5pF	±0.05pF	GJM1555C1H6R4BB01#
				±0.25pF	GJM1555C1H6R4CB01#
				±0.5pF	GJM1555C1H6R4DB01#
			6.6pF	±0.05pF	GJM1555C1H6R5WB01#
				±0.1pF	GJM1555C1H6R5BB01#
				±0.25pF	GJM1555C1H6R5CB01#
			6.7pF	±0.5pF	GJM1555C1H6R5DB01#
				±0.05pF	GJM1555C1H6R6WB01#
				±0.1pF	GJM1555C1H6R6BB01#
			6.8pF	±0.25pF	GJM1555C1H6R6CB01#
				±0.05pF	GJM1555C1H6R6DB01#
				±0.5pF	GJM1555C1H6R7WB01#
			6.9pF	±0.05pF	GJM1555C1H6R7BB01#
				±0.25pF	GJM1555C1H6R7CB01#
				±0.5pF	GJM1555C1H6R7DB01#
			7.0pF	±0.05pF	GJM1555C1H6R8WB01#
				±0.1pF	GJM1555C1H6R8BB01#
				±0.25pF	GJM1555C1H6R8CB01#
			7.1pF	±0.5pF	GJM1555C1H6R8DB01#
				±0.05pF	GJM1555C1H6R9WB01#
				±0.1pF	GJM1555C1H6R9BB01#
			7.2pF	±0.25pF	GJM1555C1H6R9CB01#
				±0.05pF	GJM1555C1H7R0WB01#
				±0.1pF	GJM1555C1H7R0BB01#
			7.3pF	±0.25pF	GJM1555C1H7R0CB01#
				±0.05pF	GJM1555C1H7R1WB01#
				±0.1pF	GJM1555C1H7R1BB01#
			7.4pF	±0.25pF	GJM1555C1H7R1CB01#
				±0.05pF	GJM1555C1H7R2WB01#
				±0.1pF	GJM1555C1H7R2BB01#
			7.5pF	±0.25pF	GJM1555C1H7R2CB01#
				±0.05pF	GJM1555C1H7R3WB01#
				±0.1pF	GJM1555C1H7R3BB01#
7.6pF	±0.25pF	GJM1555C1H7R3CB01#			

品番 #には包装仕様コードが入ります。

GRMシリーズ
 GJMシリーズ
 GMAシリーズ
 GMDシリーズ
 GQMシリーズ
 GRJシリーズ
 GR3シリーズ
 KRMシリーズ
 KR3シリーズ
 LLAシリーズ
 LLLシリーズ
 LLMシリーズ
 LLRシリーズ
 △注意/
 使用上の注意

GJMシリーズ 温度補償用 High Q 品番表

(→ ■ 1.0×0.5mm)

T寸法 最大値	定格 電圧	温度 特性	静電容量	許容差	品番
0.55mm	50Vdc	C0G	7.3pF	±0.5pF	GJM1555C1H7R3DB01#
				±0.05pF	GJM1555C1H7R4WB01#
			7.4pF	±0.1pF	GJM1555C1H7R4BB01#
				±0.25pF	GJM1555C1H7R4CB01#
				±0.5pF	GJM1555C1H7R4DB01#
				7.5pF	±0.05pF
			±0.1pF		GJM1555C1H7R5BB01#
			±0.25pF		GJM1555C1H7R5CB01#
			±0.5pF		GJM1555C1H7R5DB01#
			7.6pF	±0.05pF	GJM1555C1H7R6WB01#
				±0.1pF	GJM1555C1H7R6BB01#
				±0.25pF	GJM1555C1H7R6CB01#
				±0.5pF	GJM1555C1H7R6DB01#
			7.7pF	±0.05pF	GJM1555C1H7R7WB01#
				±0.1pF	GJM1555C1H7R7BB01#
				±0.25pF	GJM1555C1H7R7CB01#
				±0.5pF	GJM1555C1H7R7DB01#
			7.8pF	±0.05pF	GJM1555C1H7R8WB01#
				±0.1pF	GJM1555C1H7R8BB01#
				±0.25pF	GJM1555C1H7R8CB01#
				±0.5pF	GJM1555C1H7R8DB01#
			7.9pF	±0.05pF	GJM1555C1H7R9WB01#
				±0.1pF	GJM1555C1H7R9BB01#
				±0.25pF	GJM1555C1H7R9CB01#
				±0.5pF	GJM1555C1H7R9DB01#
			8.0pF	±0.05pF	GJM1555C1H8R0WB01#
				±0.1pF	GJM1555C1H8R0BB01#
				±0.25pF	GJM1555C1H8R0CB01#
				±0.5pF	GJM1555C1H8R0DB01#
			8.1pF	±0.05pF	GJM1555C1H8R1WB01#
				±0.1pF	GJM1555C1H8R1BB01#
				±0.25pF	GJM1555C1H8R1CB01#
				±0.5pF	GJM1555C1H8R1DB01#
			8.2pF	±0.05pF	GJM1555C1H8R2WB01#
				±0.1pF	GJM1555C1H8R2BB01#
				±0.25pF	GJM1555C1H8R2CB01#
				±0.5pF	GJM1555C1H8R2DB01#
			8.3pF	±0.05pF	GJM1555C1H8R3WB01#
				±0.1pF	GJM1555C1H8R3BB01#
				±0.25pF	GJM1555C1H8R3CB01#
				±0.5pF	GJM1555C1H8R3DB01#
			8.4pF	±0.05pF	GJM1555C1H8R4WB01#
				±0.1pF	GJM1555C1H8R4BB01#
				±0.25pF	GJM1555C1H8R4CB01#
				±0.5pF	GJM1555C1H8R4DB01#
			8.5pF	±0.05pF	GJM1555C1H8R5WB01#
				±0.1pF	GJM1555C1H8R5BB01#
				±0.25pF	GJM1555C1H8R5CB01#
				±0.5pF	GJM1555C1H8R5DB01#
			8.6pF	±0.05pF	GJM1555C1H8R6WB01#
				±0.1pF	GJM1555C1H8R6BB01#
				±0.25pF	GJM1555C1H8R6CB01#
				±0.5pF	GJM1555C1H8R6DB01#
			8.7pF	±0.05pF	GJM1555C1H8R7WB01#

T寸法 最大値	定格 電圧	温度 特性	静電容量	許容差	品番
0.55mm	50Vdc	C0G	8.7pF	±0.1pF	GJM1555C1H8R7BB01#
				±0.25pF	GJM1555C1H8R7CB01#
				±0.5pF	GJM1555C1H8R7DB01#
			8.8pF	±0.05pF	GJM1555C1H8R8WB01#
				±0.1pF	GJM1555C1H8R8BB01#
				±0.25pF	GJM1555C1H8R8CB01#
			8.9pF	±0.05pF	GJM1555C1H8R9WB01#
				±0.1pF	GJM1555C1H8R9BB01#
				±0.25pF	GJM1555C1H8R9CB01#
			9.0pF	±0.05pF	GJM1555C1H9R0WB01#
				±0.1pF	GJM1555C1H9R0BB01#
				±0.25pF	GJM1555C1H9R0CB01#
			9.1pF	±0.05pF	GJM1555C1H9R1WB01#
				±0.1pF	GJM1555C1H9R1BB01#
				±0.25pF	GJM1555C1H9R1CB01#
			9.2pF	±0.05pF	GJM1555C1H9R2WB01#
				±0.1pF	GJM1555C1H9R2BB01#
				±0.25pF	GJM1555C1H9R2CB01#
			9.3pF	±0.05pF	GJM1555C1H9R3WB01#
				±0.1pF	GJM1555C1H9R3BB01#
				±0.25pF	GJM1555C1H9R3CB01#
			9.4pF	±0.05pF	GJM1555C1H9R4WB01#
				±0.1pF	GJM1555C1H9R4BB01#
				±0.25pF	GJM1555C1H9R4CB01#
			9.5pF	±0.05pF	GJM1555C1H9R5WB01#
				±0.1pF	GJM1555C1H9R5BB01#
				±0.25pF	GJM1555C1H9R5CB01#
			9.6pF	±0.05pF	GJM1555C1H9R6WB01#
				±0.1pF	GJM1555C1H9R6BB01#
				±0.25pF	GJM1555C1H9R6CB01#
			9.7pF	±0.05pF	GJM1555C1H9R7WB01#
				±0.1pF	GJM1555C1H9R7BB01#
				±0.25pF	GJM1555C1H9R7CB01#
			9.8pF	±0.05pF	GJM1555C1H9R8WB01#
				±0.1pF	GJM1555C1H9R8BB01#
				±0.25pF	GJM1555C1H9R8CB01#
			9.9pF	±0.05pF	GJM1555C1H9R9WB01#
				±0.1pF	GJM1555C1H9R9BB01#
				±0.25pF	GJM1555C1H9R9CB01#
			10pF	±2%	GJM1555C1H100GB01#
				±5%	GJM1555C1H100JB01#
			11pF	±2%	GJM1555C1H110GB01#

品番 #には包装仕様コードが入ります。

GRMシリーズ
GJMシリーズ
GMAシリーズ
GMDシリーズ
GQMシリーズ
GRJシリーズ
GR3シリーズ
KRMシリーズ
KR3シリーズ
LLAシリーズ
LLLシリーズ
LLMシリーズ
LLRシリーズ
△注意/
使用上の注意

GJMシリーズ 温度補償用 **High Q** 品番表

(→ ■ 1.0×0.5mm)

T寸法 最大値	定格 電圧	温度 特性	静電容量	許容差	品番
0.55mm	50Vdc	C0G	11pF	±5%	GJM1555C1H110JB01#
				±2%	GJM1555C1H120GB01#
			12pF	±5%	GJM1555C1H120JB01#
				±2%	GJM1555C1H130GB01#
			13pF	±5%	GJM1555C1H130JB01#
				±2%	GJM1555C1H150GB01#
			15pF	±5%	GJM1555C1H150JB01#
				±2%	GJM1555C1H160GB01#
			16pF	±5%	GJM1555C1H160JB01#
				±2%	GJM1555C1H180GB01#
			18pF	±5%	GJM1555C1H180JB01#
				±2%	GJM1555C1H200GB01#
			20pF	±5%	GJM1555C1H200JB01#
				±1%	GJM1555C1H220FB01#
			22pF	±2%	GJM1555C1H220GB01#
				±5%	GJM1555C1H220JB01#
				±1%	GJM1555C1H240FB01#
			24pF	±2%	GJM1555C1H240GB01#
				±5%	GJM1555C1H240JB01#
				±1%	GJM1555C1H270FB01#
			27pF	±2%	GJM1555C1H270GB01#
				±5%	GJM1555C1H270JB01#
				±1%	GJM1555C1H300FB01#
			30pF	±2%	GJM1555C1H300GB01#
				±5%	GJM1555C1H300JB01#
				±1%	GJM1555C1H330FB01#
			33pF	±2%	GJM1555C1H330GB01#
				±5%	GJM1555C1H330JB01#
				±1%	GJM1555C1H360FB01#
			36pF	±2%	GJM1555C1H360GB01#
				±5%	GJM1555C1H360JB01#
				±1%	GJM1555C1H390FB01#
			39pF	±2%	GJM1555C1H390GB01#
				±5%	GJM1555C1H390JB01#
				±1%	GJM1555C1H430FB01#
			43pF	±2%	GJM1555C1H430GB01#
				±5%	GJM1555C1H430JB01#
				±1%	GJM1555C1H470FB01#
			47pF	±2%	GJM1555C1H470GB01#
				±5%	GJM1555C1H470JB01#

GRMシリーズ

GJMシリーズ

GMAシリーズ

GMDシリーズ

GQMシリーズ

GRJシリーズ

GR3シリーズ

KRMシリーズ

KR3シリーズ

LLAシリーズ

LLIシリーズ

LLMシリーズ

LLRシリーズ

△注意/
使用上の注意

ボンディング対応上下電極品

GMAシリーズ

**Auめっきの外部電極によりワイヤボンディング実装対応のコンデンサです。
 上下電極構造でICパッケージ内への実装も可能！**

特徴

① 高密度実装が可能。

IC等のパッケージ内に内蔵することで、配線引き回しの削減による低ノイズ化・高性能化が可能です。
 また、セットの小型化も可能です。

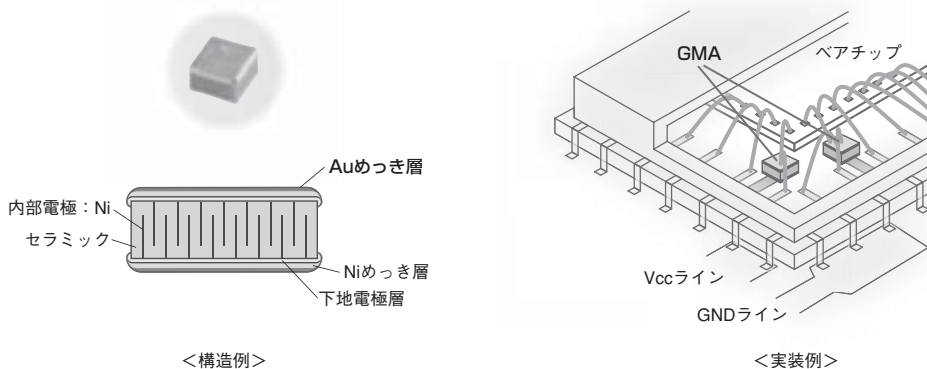

② バイパス用途に最適。

積層構造であるため、小型・大容量を実現しています。

③ 高周波特性に優れます。

上下電極構造であるため、電流のパスが短くなり、ESLが小さくなります。
 同容量の一般用のGRMシリーズに比べ、高周波においてインピーダンスが小さくなります。

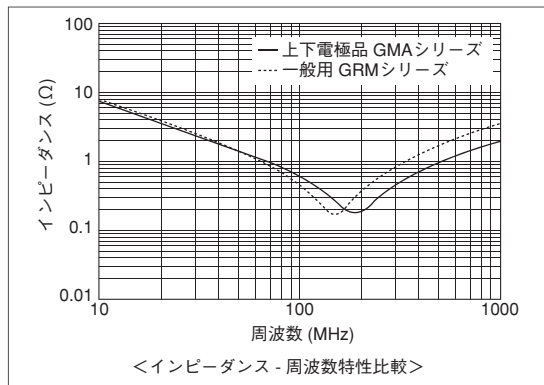

主な仕様

サイズ	0.38×0.38mm～0.8×0.8mm
定格電圧	DC6.3V～100V
静電容量	100pF～0.47μF
主な用途	1. 光通信関係機器 2. GaAs IC等各種デバイス関連 (ICパッケージ内への実装) 3. 計測器、その他超小型/薄型機器

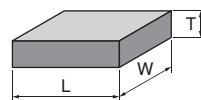

＜外形寸法図＞

当カタログに掲載している製品は一部です。
 詳しくはWebサイトのコンデンサ検索ページをご参照ください。

GMAシリーズ 高誘電率系 品番表

■0.38×0.38mm 超小型

T寸法 最大値	定格 電圧	温度 特性	静電容量	許容差	品番
0.35mm	10Vdc	R	1000pF	±20%	GMA0D3R11A102MA01#
			1500pF	±20%	GMA0D3R11A152MA01#
			1800pF	±20%	GMA0D3R11A182MA01#
			10000pF	±20%	GMA0D3R11A103MA01#
		X7R	1000pF	±20%	GMA0D3R71A102MA01#
			1500pF	±20%	GMA0D3R71A152MA01#
			1800pF	±20%	GMA0D3R71A182MA01#
			10000pF	±20%	GMA0D3R71A103MA01#
		B	1000pF	±20%	GMA0D3B11A102MA01#
			1500pF	±20%	GMA0D3B11A152MA01#
			1800pF	±20%	GMA0D3B11A182MA01#
			1800pF	±20%	GMA0D3B11A182MA01#

■0.5×0.5mm

T寸法 最大値	定格 電圧	温度 特性	静電容量	許容差	品番	
0.4mm	100Vdc	X7R	100pF	±20%	GMA05XR72A101MA01#	
			150pF	±20%	GMA05XR72A151MA01#	
			220pF	±20%	GMA05XR72A221MA01#	
			330pF	±20%	GMA05XR72A331MA01#	
			470pF	±20%	GMA05XR72A471MA01#	
			680pF	±20%	GMA05XR72A681MA01#	
			1000pF	±20%	GMA05XR72A102MA01#	
			1500pF	±20%	GMA05XR71E152MA11#	
		25Vdc	X7R	2200pF	±20%	GMA05XR71E222MA11#
				3300pF	±20%	GMA05XR71E332MA11#
				4700pF	±20%	GMA05XR71E472MA11#
				1500pF	±20%	GMA05XB31E152MA11#
			B	2200pF	±20%	GMA05XB31E222MA11#
				3300pF	±20%	GMA05XB31E332MA11#
				4700pF	±20%	GMA05XB31E472MA11#
				10Vdc	R	6800pF
		10000pF	±20%			GMA05XR11A103MA01#
		15000pF	±20%			GMA05XR11A153MA01#
		22000pF	±20%			GMA05XR11A223MA01#
		X7R	6800pF		±20%	GMA05XR71A682MA01#
			10000pF		±20%	GMA05XR71A103MA01#
			15000pF		±20%	GMA05XR71A153MA01#
			22000pF		±20%	GMA05XR71A223MA01#
		B	6800pF		±20%	GMA05XB11A682MA01#
	10000pF		±20%		GMA05XB11A103MA01#	
	15000pF		±20%		GMA05XB11A153MA01#	
	22000pF		±20%		GMA05XB11A223MA01#	
	6.3Vdc	B	0.10μF	±20%	GMA05XB30J104ME12#	
			0.10μF	±20%	GMA05XB30J104ME12#	
		X5R	0.10μF	±20%	GMA05XR60J104ME12#	
			0.10μF	±20%	GMA05XR60J104ME12#	

■0.8×0.8mm

T寸法 最大値	定格 電圧	温度 特性	静電容量	許容差	品番
0.6mm	100Vdc	X7R	1500pF	±20%	GMA085R72A152MA01#
			2200pF	±20%	GMA085R72A222MA01#

T寸法 最大値	定格 電圧	温度 特性	静電容量	許容差	品番	
0.6mm	100Vdc	X7R	3300pF	±20%	GMA085R72A332MA01#	
			4700pF	±20%	GMA085R72A472MA01#	
			6800pF	±20%	GMA085R72A682MA01#	
		25Vdc	X7R	10000pF	±20%	GMA085R71E103MA11#
				15000pF	±20%	GMA085R71E153MA11#
				22000pF	±20%	GMA085R71E223MA11#
	B		10000pF	±20%	GMA085B31E103MA11#	
			15000pF	±20%	GMA085B31E153MA11#	
			22000pF	±20%	GMA085B31E223MA11#	
	10Vdc	R	33000pF	±20%	GMA085R11A333MA01#	
			47000pF	±20%	GMA085R11A473MA01#	
			68000pF	±20%	GMA085R11A683MA01#	
			0.10μF	±20%	GMA085R11A104MA01#	
			X7R	33000pF	±20%	GMA085R71A333MA01#
				47000pF	±20%	GMA085R71A473MA01#
		68000pF		±20%	GMA085R71A683MA01#	
		6.3Vdc	B	0.10μF	±20%	GMA085R71A104MA01#
				0.10μF	±20%	GMA085B11A333MA01#
				0.10μF	±20%	GMA085B11A473MA01#
			X5R	0.47μF	±20%	GMA085B11A683MA01#
				0.47μF	±20%	GMA085B11A104MA01#
	0.47μF			±20%	GMA085B30J474ME12#	
						GMA085R60J474ME12#

品番 #には包装仕様コードが入ります。

GRMシリーズ
 GJMシリーズ
 GMAシリーズ
 GMDシリーズ
 GGMシリーズ
 GRJシリーズ
 GR3シリーズ
 KRMシリーズ
 KR3シリーズ
 LLAシリーズ
 LLLシリーズ
 LLMシリーズ
 LLRシリーズ
 △注意/
 使用上の注意

ボンディング/AuSnはんだ対応品

GMDシリーズ

Auめっきの外部電極によりワイヤボンディング実装に対応したコンデンサです。

特徴

① ワイヤボンディング実装、AuSnはんだ実装が可能。

外部電極がAuめっき仕様のため、ワイヤ/ダイボンディング実装が可能です。

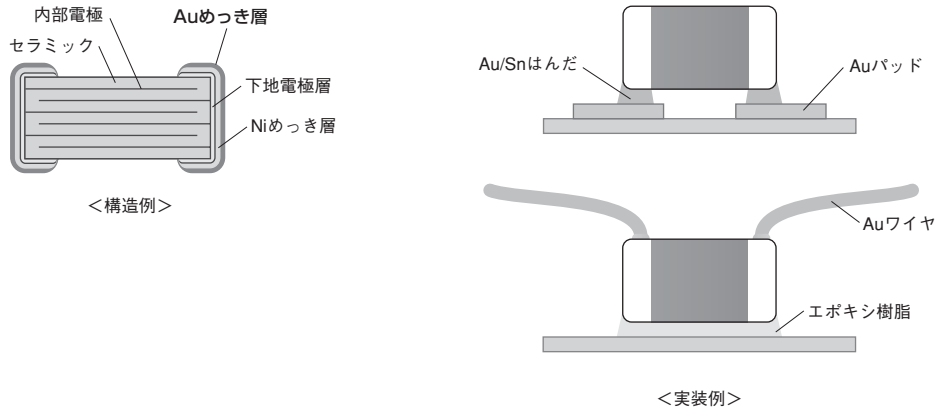

② 光通信関係機器、IC等のパッケージ内への実装に最適。

TO-CANやIC等のパッケージ内に、ワイヤボンディング実装によってコンデンサを内蔵することで、配線引き回しの削減による低ノイズ化・高性能化が可能です。

③ セットの小型化に貢献。

0603、1005(in mm)サイズの小型品をラインアップしています。

主な仕様

サイズ	0.6×0.3mm～1.0×0.5mm
定格電圧	DC6.3V～50V
静電容量	100pF～1.0μF
主な用途	1. 光通信関係機器 2. ICパッケージ内への実装

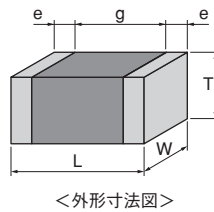

当カタログに掲載している製品は一部です。
 詳しくはWebサイトのコンデンサ検索ページをご参照ください。

GRMシリーズ

GJMシリーズ

GMAシリーズ

GMDシリーズ

GQMシリーズ

GRJシリーズ

GRSシリーズ

KRMシリーズ

KRSシリーズ

LLAシリーズ

LLLシリーズ

LLMシリーズ

LLRシリーズ

△注意/
使用上の注意

GMDシリーズ 高誘電率系 品番表

■0.6×0.3mm 超小型

寸法 最大値	定格 電圧	温度 特性	静電容量	許容差	品番	
0.33mm	25Vdc	R	100pF	±10%	GMD033R11E101KA01#	
			120pF	±10%	GMD033R11E121KA01#	
			150pF	±10%	GMD033R11E151KA01#	
			180pF	±10%	GMD033R11E181KA01#	
			220pF	±10%	GMD033R11E221KA01#	
			270pF	±10%	GMD033R11E271KA01#	
			330pF	±10%	GMD033R11E331KA01#	
			390pF	±10%	GMD033R11E391KA01#	
			470pF	±10%	GMD033R11E471KA01#	
			560pF	±10%	GMD033R11E561KA01#	
			680pF	±10%	GMD033R11E681KA01#	
			820pF	±10%	GMD033R11E821KA01#	
			1000pF	±10%	GMD033R11E102KA01#	
			1200pF	±10%	GMD033R11E122KA01#	
			1500pF	±10%	GMD033R11E152KA01#	
			X7R	100pF	±10%	GMD033R71E101KA01#
				120pF	±10%	GMD033R71E121KA01#
				150pF	±10%	GMD033R71E151KA01#
		180pF		±10%	GMD033R71E181KA01#	
		220pF		±10%	GMD033R71E221KA01#	
		270pF		±10%	GMD033R71E271KA01#	
		330pF		±10%	GMD033R71E331KA01#	
		390pF		±10%	GMD033R71E391KA01#	
		470pF		±10%	GMD033R71E471KA01#	
		560pF		±10%	GMD033R71E561KA01#	
		680pF		±10%	GMD033R71E681KA01#	
		820pF		±10%	GMD033R71E821KA01#	
		1000pF		±10%	GMD033R71E102KA01#	
		1200pF		±10%	GMD033R71E122KA01#	
		1500pF		±10%	GMD033R71E152KA01#	
		B		100pF	±10%	GMD033B11E101KA01#
				120pF	±10%	GMD033B11E121KA01#
				150pF	±10%	GMD033B11E151KA01#
			180pF	±10%	GMD033B11E181KA01#	
			220pF	±10%	GMD033B11E221KA01#	
			270pF	±10%	GMD033B11E271KA01#	
			330pF	±10%	GMD033B11E331KA01#	
			390pF	±10%	GMD033B11E391KA01#	
			470pF	±10%	GMD033B11E471KA01#	
			560pF	±10%	GMD033B11E561KA01#	
			680pF	±10%	GMD033B11E681KA01#	
			820pF	±10%	GMD033B11E821KA01#	
			1000pF	±10%	GMD033B11E102KA01#	
			1200pF	±10%	GMD033B11E122KA01#	
			1500pF	±10%	GMD033B11E152KA01#	
			R	1800pF	±10%	GMD033R11C182KA11#
				2200pF	±10%	GMD033R11C222KA11#
				2700pF	±10%	GMD033R11C272KA11#
		3300pF		±10%	GMD033R11C332KA11#	
		X7R		1800pF	±10%	GMD033R71C182KA11#
				2200pF	±10%	GMD033R71C222KA11#
				2700pF	±10%	GMD033R71C272KA11#

寸法 最大値	定格 電圧	温度 特性	静電容量	許容差	品番	
0.33mm	16Vdc	X7R	3300pF	±10%	GMD033R71C332KA11#	
			1800pF	±10%	GMD033B31C182KA11#	
			2200pF	±10%	GMD033B31C222KA11#	
			2700pF	±10%	GMD033B31C272KA11#	
		10Vdc	R	3900pF	±10%	GMD033R11A392KA01#
				4700pF	±10%	GMD033R11A472KA01#
				5600pF	±10%	GMD033R11A562KA01#
				6800pF	±10%	GMD033R11A682KA01#
				8200pF	±10%	GMD033R11A822KA01#
				10000pF	±10%	GMD033R11A103KA01#
			X7R	3900pF	±10%	GMD033R71A392KA01#
				4700pF	±10%	GMD033R71A472KA01#
	5600pF			±10%	GMD033R71A562KA01#	
	6800pF			±10%	GMD033R71A682KA01#	
	8200pF			±10%	GMD033R71A822KA01#	
	10000pF			±10%	GMD033R71A103KA01#	
	B			3900pF	±10%	GMD033B11A392KA01#
				4700pF	±10%	GMD033B11A472KA01#
				5600pF	±10%	GMD033B11A562KA01#
		6800pF	±10%	GMD033B11A682KA01#		
		8200pF	±10%	GMD033B11A822KA01#		
		10000pF	±10%	GMD033B11A103KA01#		
	6.3Vdc	B	5600pF	±10%	GMD033B30J563KE11#	
			6800pF	±10%	GMD033B30J683KE11#	
			8200pF	±10%	GMD033B30J823KE11#	
			0.10μF	±10%	GMD033B30J104KE11#	
			X5R	5600pF	±10%	GMD033R60J563KE11#
6800pF				±10%	GMD033R60J683KE11#	
8200pF		±10%		GMD033R60J823KE11#		
0.10μF		±10%		GMD033R60J104KE11#		

■1.0×0.5mm

寸法 最大値	定格 電圧	温度 特性	静電容量	許容差	品番
0.55mm	50Vdc	R	220pF	±10%	GMD155R11H221KA01#
			270pF	±10%	GMD155R11H271KA01#
			330pF	±10%	GMD155R11H331KA01#
			390pF	±10%	GMD155R11H391KA01#
			470pF	±10%	GMD155R11H471KA01#
			560pF	±10%	GMD155R11H561KA01#
			680pF	±10%	GMD155R11H681KA01#
			820pF	±10%	GMD155R11H821KA01#
			1000pF	±10%	GMD155R11H102KA01#
			1200pF	±10%	GMD155R11H122KA01#
			1500pF	±10%	GMD155R11H152KA01#
			1800pF	±10%	GMD155R11H182KA01#
			2200pF	±10%	GMD155R11H222KA01#
			2700pF	±10%	GMD155R11H272KA01#
			3300pF	±10%	GMD155R11H332KA01#
			3900pF	±10%	GMD155R11H392KA01#
			4700pF	±10%	GMD155R11H472KA01#
			X7R	220pF	±10%

品番 #には包装仕様コードが入ります。

GRMシリーズ
GJMシリーズ
GMAシリーズ
GMDシリーズ
GGMシリーズ
GRJシリーズ
GR3シリーズ
KRMシリーズ
KR3シリーズ
LLAシリーズ
LLLシリーズ
LLMシリーズ
LLRシリーズ
△注意/
使用上の注意

GMDシリーズ 高誘電率系 品番表

(→ ■ 1.0×0.5mm)

T寸法 最大値	定格 電圧	温度 特性	静電容量	許容差	品番	
0.55mm	50Vdc	X7R	270pF	±10%	GMD155R71H271KA01#	
			330pF	±10%	GMD155R71H331KA01#	
			390pF	±10%	GMD155R71H391KA01#	
			470pF	±10%	GMD155R71H471KA01#	
			560pF	±10%	GMD155R71H561KA01#	
			680pF	±10%	GMD155R71H681KA01#	
			820pF	±10%	GMD155R71H821KA01#	
			1000pF	±10%	GMD155R71H102KA01#	
			1200pF	±10%	GMD155R71H122KA01#	
			1500pF	±10%	GMD155R71H152KA01#	
			1800pF	±10%	GMD155R71H182KA01#	
			2200pF	±10%	GMD155R71H222KA01#	
			2700pF	±10%	GMD155R71H272KA01#	
			3300pF	±10%	GMD155R71H332KA01#	
			3900pF	±10%	GMD155R71H392KA01#	
			4700pF	±10%	GMD155R71H472KA01#	
			B	220pF	±10%	GMD155B11H221KA01#
				270pF	±10%	GMD155B11H271KA01#
				330pF	±10%	GMD155B11H331KA01#
				390pF	±10%	GMD155B11H391KA01#
				470pF	±10%	GMD155B11H471KA01#
				560pF	±10%	GMD155B11H561KA01#
				680pF	±10%	GMD155B11H681KA01#
				820pF	±10%	GMD155B11H821KA01#
				1000pF	±10%	GMD155B11H102KA01#
				1200pF	±10%	GMD155B11H122KA01#
				1500pF	±10%	GMD155B11H152KA01#
	1800pF	±10%		GMD155B11H182KA01#		
	2200pF	±10%		GMD155B11H222KA01#		
	2700pF	±10%		GMD155B11H272KA01#		
	3300pF	±10%		GMD155B11H332KA01#		
	3900pF	±10%		GMD155B11H392KA01#		
	4700pF	±10%		GMD155B11H472KA01#		
	R	5600pF		±10%	GMD155R11E562KA01#	
		6800pF		±10%	GMD155R11E682KA01#	
		8200pF		±10%	GMD155R11E822KA01#	
		10000pF	±10%	GMD155R11E103KA01#		
		12000pF	±10%	GMD155R11E123KA01#		
		15000pF	±10%	GMD155R11E153KA01#		
		18000pF	±10%	GMD155R11E183KA01#		
		22000pF	±10%	GMD155R11E223KA01#		
		27000pF	±10%	GMD155R11E273KA11#		
		33000pF	±10%	GMD155R11E333KA11#		
		39000pF	±10%	GMD155R11E393KA11#		
		47000pF	±10%	GMD155R11E473KA11#		
		X7R	5600pF	±10%	GMD155R71E562KA01#	
			6800pF	±10%	GMD155R71E682KA01#	
8200pF			±10%	GMD155R71E822KA01#		
10000pF			±10%	GMD155R71E103KA01#		
12000pF			±10%	GMD155R71E123KA01#		
15000pF			±10%	GMD155R71E153KA01#		
18000pF			±10%	GMD155R71E183KA01#		
22000pF			±10%	GMD155R71E223KA01#		
27000pF	±10%		GMD155R71E273KA11#			
33000pF	±10%		GMD155R71E333KA11#			

T寸法 最大値	定格 電圧	温度 特性	静電容量	許容差	品番		
0.55mm	25Vdc	X7R	33000pF	±10%	GMD155R71E333KA11#		
			39000pF	±10%	GMD155R71E393KA11#		
			47000pF	±10%	GMD155R71E473KA11#		
			B	5600pF	±10%	GMD155B11E562KA01#	
				6800pF	±10%	GMD155B11E682KA01#	
				8200pF	±10%	GMD155B11E822KA01#	
				10000pF	±10%	GMD155B11E103KA01#	
				12000pF	±10%	GMD155B11E123KA01#	
				15000pF	±10%	GMD155B11E153KA01#	
		R	18000pF	±10%	GMD155B11E183KA01#		
			22000pF	±10%	GMD155B11E223KA01#		
			27000pF	±10%	GMD155B31E273KA11#		
			33000pF	±10%	GMD155B31E333KA11#		
			39000pF	±10%	GMD155B31E393KA11#		
			47000pF	±10%	GMD155B31E473KA11#		
			X7R	56000pF	±10%	GMD155R71C563KA11#	
				68000pF	±10%	GMD155R71C683KA11#	
				82000pF	±10%	GMD155R71C823KA11#	
				0.10μF	±10%	GMD155R71C104KA11#	
				B	56000pF	±10%	GMD155B31C563KA11#
					68000pF	±10%	GMD155B31C683KA11#
		82000pF	±10%		GMD155B31C823KA11#		
		0.10μF	±10%		GMD155B31C104KA11#		
		16Vdc	R		56000pF	±10%	GMD155R11C563KA11#
					68000pF	±10%	GMD155R11C683KA11#
				82000pF	±10%	GMD155R11C823KA11#	
				0.10μF	±10%	GMD155R11C104KA11#	
	X7R			56000pF	±10%	GMD155R71C563KA11#	
				68000pF	±10%	GMD155R71C683KA11#	
			82000pF	±10%	GMD155R71C823KA11#		
			0.10μF	±10%	GMD155R71C104KA11#		
			B	56000pF	±10%	GMD155B31C563KA11#	
				68000pF	±10%	GMD155B31C683KA11#	
	82000pF			±10%	GMD155B31C823KA11#		
	0.10μF			±10%	GMD155B31C104KA11#		
	10Vdc			B	0.12μF	±10%	GMD155B31A124KE12#
					0.15μF	±10%	GMD155B31A154KE12#
			0.18μF		±10%	GMD155B31A184KE12#	
			0.22μF		±10%	GMD155B31A224KE12#	
			0.27μF		±10%	GMD155B31A274KE11#	
			0.33μF		±10%	GMD155B31A334KE11#	
		0.39μF	±10%		GMD155B31A394KE11#		
		0.47μF	±10%		GMD155B31A474KE11#		
		X5R	0.12μF		±10%	GMD155R61A124KE12#	
	0.15μF		±10%	GMD155R61A154KE12#			
	0.18μF		±10%	GMD155R61A184KE12#			
	0.22μF		±10%	GMD155R61A224KE12#			
	0.27μF		±10%	GMD155R61A274KE11#			
	0.33μF		±10%	GMD155R61A334KE11#			
	0.39μF		±10%	GMD155R61A394KE11#			
	0.47μF		±10%	GMD155R61A474KE11#			

GRMSシリーズ
GJMシリーズ
GMAシリーズ
GMDシリーズ
GQMシリーズ
GRJシリーズ
GR3シリーズ
KRMシリーズ
KR3シリーズ
LLAシリーズ
LLLシリーズ
LLMシリーズ
LLRシリーズ
△注意/
使用上の注意

GRMシリーズ

GJMシリーズ

GMAシリーズ

GMDシリーズ

GQMシリーズ

GRJシリーズ

GR3シリーズ

KRMシリーズ

KR3シリーズ

LLAシリーズ

LLLシリーズ

LLMシリーズ

LLRシリーズ

△注意/
使用上の注意

高周波用High Q品 1608(in mm)サイズ以上

GQMシリーズ High Q

基地局用PA設計に最適な高周波用コンデンサ

特徴

① 主に移動体通信機器用基地局および関連モジュール温度補償用として最適。

共振回路や同調回路、インピーダンスマッチング回路といった、容量変動が機器の動作特性に大きく影響する高周波回路の温度補償用に最適です。

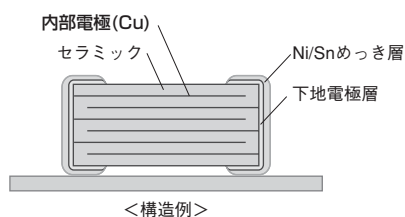

<構造例>

② VHF、UHF、マイクロ波の周波数帯で、High Q、低ESR。

誘電体材料に高周波での損失が非常に小さいセラミック材料、内部電極に銅を採用することにより、高周波でHigh Q、低ESRを実現しました。

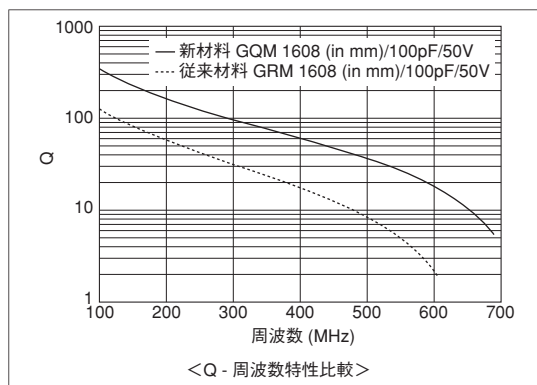
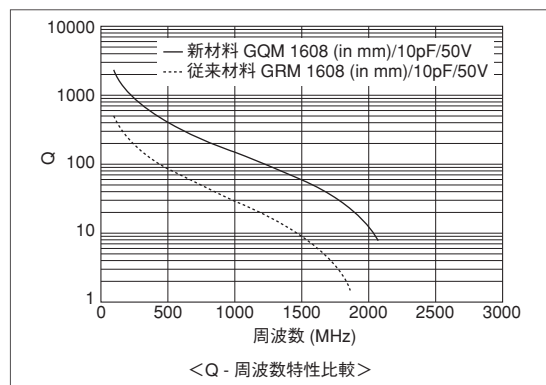

③ 狭静電容量許容差に対応。

標準静電容量許容差以外にも静電容量範囲により以下の狭静電容量許容差に対応しています。

静電容量範囲	標準静電容量許容差（静電容量許容差記号）	狭静電容量許容差（静電容量許容差記号）
~0.9pF	±0.1pF (B)	±0.05pF (W)
1.0~5.0pF	±0.25pF (C)	±0.05pF (W)、±0.1pF (B)
5.1~9.9pF	±0.5pF (D)	±0.05pF (W)、±0.1pF (B)、±0.25pF (C)
10pF~	±5% (J)	±2% (G)

主な仕様

サイズ	1.0×0.5mm~2.8×2.8mm
定格電圧	DC50V~500V
静電容量	0.1pF~200pF
主な用途	携帯電話基地局

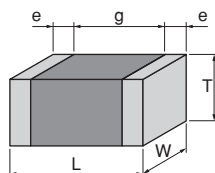

<外形寸法図>

当カタログに掲載している製品は一部です。
 詳しくはWebサイトのコンデンサ検索ページをご参照ください。

GQMシリーズ 温度補償用 High Q 品番表

■ 1.6×0.8mm

T寸法 最大値	定格 電圧	温度 特性	静電容量	許容差	品番
0.8mm	250Vdc	C0G	1.0pF	±0.1pF	GQM1875C2E1R0BB12#
				±0.25pF	GQM1875C2E1R0CB12#
			1.1pF	±0.1pF	GQM1875C2E1R1BB12#
				±0.25pF	GQM1875C2E1R1CB12#
			1.2pF	±0.1pF	GQM1875C2E1R2BB12#
				±0.25pF	GQM1875C2E1R2CB12#
			1.3pF	±0.1pF	GQM1875C2E1R3BB12#
				±0.25pF	GQM1875C2E1R3CB12#
			1.5pF	±0.1pF	GQM1875C2E1R5BB12#
				±0.25pF	GQM1875C2E1R5CB12#
			1.6pF	±0.1pF	GQM1875C2E1R6BB12#
				±0.25pF	GQM1875C2E1R6CB12#
			1.8pF	±0.1pF	GQM1875C2E1R8BB12#
				±0.25pF	GQM1875C2E1R8CB12#
			2.0pF	±0.1pF	GQM1875C2E2R0BB12#
				±0.25pF	GQM1875C2E2R0CB12#
			2.2pF	±0.1pF	GQM1875C2E2R2BB12#
				±0.25pF	GQM1875C2E2R2CB12#
			2.4pF	±0.1pF	GQM1875C2E2R4BB12#
				±0.25pF	GQM1875C2E2R4CB12#
			2.7pF	±0.1pF	GQM1875C2E2R7BB12#
				±0.25pF	GQM1875C2E2R7CB12#
			3.0pF	±0.1pF	GQM1875C2E3R0BB12#
				±0.25pF	GQM1875C2E3R0CB12#
			3.3pF	±0.1pF	GQM1875C2E3R3BB12#
				±0.25pF	GQM1875C2E3R3CB12#
			3.6pF	±0.1pF	GQM1875C2E3R6BB12#
				±0.25pF	GQM1875C2E3R6CB12#
			3.9pF	±0.1pF	GQM1875C2E3R9BB12#
				±0.25pF	GQM1875C2E3R9CB12#
			4.0pF	±0.1pF	GQM1875C2E4R0BB12#
				±0.25pF	GQM1875C2E4R0CB12#
			4.3pF	±0.1pF	GQM1875C2E4R3BB12#
				±0.25pF	GQM1875C2E4R3CB12#
			4.7pF	±0.1pF	GQM1875C2E4R7BB12#
				±0.25pF	GQM1875C2E4R7CB12#
			5.0pF	±0.1pF	GQM1875C2E5R0BB12#
				±0.25pF	GQM1875C2E5R0CB12#
			5.1pF	±0.25pF	GQM1875C2E5R1CB12#
				±0.5pF	GQM1875C2E5R1DB12#
			5.6pF	±0.25pF	GQM1875C2E5R6CB12#
				±0.5pF	GQM1875C2E5R6DB12#
			6.0pF	±0.25pF	GQM1875C2E6R0CB12#
				±0.5pF	GQM1875C2E6R0DB12#
			6.2pF	±0.25pF	GQM1875C2E6R2CB12#
				±0.5pF	GQM1875C2E6R2DB12#
			6.8pF	±0.25pF	GQM1875C2E6R8CB12#
				±0.5pF	GQM1875C2E6R8DB12#
7.0pF	±0.25pF	GQM1875C2E7R0CB12#			
	±0.5pF	GQM1875C2E7R0DB12#			
7.5pF	±0.25pF	GQM1875C2E7R5CB12#			
	±0.5pF	GQM1875C2E7R5DB12#			

T寸法 最大値	定格 電圧	温度 特性	静電容量	許容差	品番			
0.8mm	250Vdc	C0G	8.0pF	±0.25pF	GQM1875C2E8R0CB12#			
				±0.5pF	GQM1875C2E8R0DB12#			
			8.2pF	±0.25pF	GQM1875C2E8R2CB12#			
				±0.5pF	GQM1875C2E8R2DB12#			
			9.0pF	±0.25pF	GQM1875C2E9R0CB12#			
				±0.5pF	GQM1875C2E9R0DB12#			
			9.1pF	±0.25pF	GQM1875C2E9R1CB12#			
				±0.5pF	GQM1875C2E9R1DB12#			
			10pF	±2%	GQM1875C2E100GB12#			
				±5%	GQM1875C2E100JB12#			
			11pF	±2%	GQM1875C2E110GB12#			
				±5%	GQM1875C2E110JB12#			
			12pF	±2%	GQM1875C2E120GB12#			
				±5%	GQM1875C2E120JB12#			
			13pF	±2%	GQM1875C2E130GB12#			
				±5%	GQM1875C2E130JB12#			
			15pF	±2%	GQM1875C2E150GB12#			
				±5%	GQM1875C2E150JB12#			
			16pF	±2%	GQM1875C2E160GB12#			
				±5%	GQM1875C2E160JB12#			
			18pF	±2%	GQM1875C2E180GB12#			
				±5%	GQM1875C2E180JB12#			
			20pF	±2%	GQM1875C2E200GB12#			
				±5%	GQM1875C2E200JB12#			
			22pF	±2%	GQM1875C2E220GB12#			
				±5%	GQM1875C2E220JB12#			
			24pF	±2%	GQM1875C2E240GB12#			
				±5%	GQM1875C2E240JB12#			
			27pF	±2%	GQM1875C2E270GB12#			
				±5%	GQM1875C2E270JB12#			
			30pF	±2%	GQM1875C2E300GB12#			
				±5%	GQM1875C2E300JB12#			
			33pF	±2%	GQM1875C2E330GB12#			
				±5%	GQM1875C2E330JB12#			
			36pF	±2%	GQM1875C2E360GB12#			
				±5%	GQM1875C2E360JB12#			
			39pF	±2%	GQM1875C2E390GB12#			
				±5%	GQM1875C2E390JB12#			
			43pF	±2%	GQM1875C2E430GB12#			
				±5%	GQM1875C2E430JB12#			
			47pF	±2%	GQM1875C2E470GB12#			
				±5%	GQM1875C2E470JB12#			
			0.9mm	100Vdc	CK	1.0pF	±0.1pF	GQM1884C2A1R0BB01#
							±0.25pF	GQM1884C2A1R0CB01#
						1.1pF	±0.1pF	GQM1884C2A1R1BB01#
							±0.25pF	GQM1884C2A1R1CB01#
						1.2pF	±0.1pF	GQM1884C2A1R2BB01#
							±0.25pF	GQM1884C2A1R2CB01#
1.3pF	±0.1pF	GQM1884C2A1R3BB01#						
	±0.25pF	GQM1884C2A1R3CB01#						
1.5pF	±0.1pF	GQM1884C2A1R5BB01#						
	±0.25pF	GQM1884C2A1R5CB01#						
1.6pF	±0.1pF	GQM1884C2A1R6BB01#						
	±0.25pF	GQM1884C2A1R6CB01#						

品番 #には包装仕様コードが入ります。

GRMシリーズ
GJMシリーズ
GMAシリーズ
GMDシリーズ
GQMシリーズ
GRJシリーズ
GR3シリーズ
KRMシリーズ
KR3シリーズ
LLAシリーズ
LLLシリーズ
LLMシリーズ
LLRシリーズ
△注意/
使用上の注意

GQMシリーズ 温度補償用 **High Q** 品番表

(→ ■ 1.6×0.8mm)

T寸法 最大値	定格 電圧	温度 特性	静電容量	許容差	品番	
0.9mm	100Vdc	CK	1.8pF	±0.1pF	GQM1884C2A1R8BB01#	
				±0.25pF	GQM1884C2A1R8CB01#	
			2.0pF	±0.1pF	GQM1884C2A2R0BB01#	
				±0.25pF	GQM1884C2A2R0CB01#	
			CJ	2.2pF	±0.1pF	GQM1883C2A2R2BB01#
					±0.25pF	GQM1883C2A2R2CB01#
				2.4pF	±0.1pF	GQM1883C2A2R4BB01#
					±0.25pF	GQM1883C2A2R4CB01#
		2.7pF		±0.1pF	GQM1883C2A2R7BB01#	
				±0.25pF	GQM1883C2A2R7CB01#	
		3.0pF		±0.1pF	GQM1883C2A3R0BB01#	
				±0.25pF	GQM1883C2A3R0CB01#	
		3.3pF		±0.1pF	GQM1883C2A3R3BB01#	
				±0.25pF	GQM1883C2A3R3CB01#	
		3.6pF		±0.1pF	GQM1883C2A3R6BB01#	
				±0.25pF	GQM1883C2A3R6CB01#	
		3.9pF	±0.1pF	GQM1883C2A3R9BB01#		
			±0.25pF	GQM1883C2A3R9CB01#		
		CH	4.0pF	±0.1pF	GQM1882C2A4R0BB01#	
				±0.25pF	GQM1882C2A4R0CB01#	
			4.3pF	±0.1pF	GQM1882C2A4R3BB01#	
				±0.25pF	GQM1882C2A4R3CB01#	
			4.7pF	±0.1pF	GQM1882C2A4R7BB01#	
				±0.25pF	GQM1882C2A4R7CB01#	
			5.0pF	±0.1pF	GQM1882C2A5R0BB01#	
				±0.25pF	GQM1882C2A5R0CB01#	
			5.1pF	±0.25pF	GQM1882C2A5R1CB01#	
				±0.5pF	GQM1882C2A5R1DB01#	
			5.6pF	±0.25pF	GQM1882C2A5R6CB01#	
				±0.5pF	GQM1882C2A5R6DB01#	
		6.0pF	±0.25pF	GQM1882C2A6R0CB01#		
			±0.5pF	GQM1882C2A6R0DB01#		
		6.2pF	±0.25pF	GQM1882C2A6R2CB01#		
			±0.5pF	GQM1882C2A6R2DB01#		
		6.8pF	±0.25pF	GQM1882C2A6R8CB01#		
			±0.5pF	GQM1882C2A6R8DB01#		
		C0G	1.0pF	±0.1pF	GQM1885C2A1R0BB01#	
				±0.25pF	GQM1885C2A1R0CB01#	
			1.1pF	±0.1pF	GQM1885C2A1R1BB01#	
				±0.25pF	GQM1885C2A1R1CB01#	
			1.2pF	±0.1pF	GQM1885C2A1R2BB01#	
				±0.25pF	GQM1885C2A1R2CB01#	
			1.3pF	±0.1pF	GQM1885C2A1R3BB01#	
				±0.25pF	GQM1885C2A1R3CB01#	
			1.5pF	±0.1pF	GQM1885C2A1R5BB01#	
				±0.25pF	GQM1885C2A1R5CB01#	
			1.6pF	±0.1pF	GQM1885C2A1R6BB01#	
				±0.25pF	GQM1885C2A1R6CB01#	
1.8pF	±0.1pF		GQM1885C2A1R8BB01#			
	±0.25pF		GQM1885C2A1R8CB01#			
2.0pF	±0.1pF		GQM1885C2A2R0BB01#			
	±0.25pF		GQM1885C2A2R0CB01#			
2.2pF	±0.1pF	GQM1885C2A2R2BB01#				
	±0.25pF	GQM1885C2A2R2CB01#				

T寸法 最大値	定格 電圧	温度 特性	静電容量	許容差	品番	
0.9mm	100Vdc	C0G	2.4pF	±0.1pF	GQM1885C2A2R4BB01#	
				±0.25pF	GQM1885C2A2R4CB01#	
			2.7pF	±0.1pF	GQM1885C2A2R7BB01#	
				±0.25pF	GQM1885C2A2R7CB01#	
			3.0pF	±0.1pF	GQM1885C2A3R0BB01#	
				±0.25pF	GQM1885C2A3R0CB01#	
			3.3pF	±0.1pF	GQM1885C2A3R3BB01#	
				±0.25pF	GQM1885C2A3R3CB01#	
			3.6pF	±0.1pF	GQM1885C2A3R6BB01#	
				±0.25pF	GQM1885C2A3R6CB01#	
			3.9pF	±0.1pF	GQM1885C2A3R9BB01#	
				±0.25pF	GQM1885C2A3R9CB01#	
			4.0pF	±0.1pF	GQM1885C2A4R0BB01#	
				±0.25pF	GQM1885C2A4R0CB01#	
			4.3pF	±0.1pF	GQM1885C2A4R3BB01#	
				±0.25pF	GQM1885C2A4R3CB01#	
			4.7pF	±0.1pF	GQM1885C2A4R7BB01#	
				±0.25pF	GQM1885C2A4R7CB01#	
			5.0pF	±0.1pF	GQM1885C2A5R0BB01#	
				±0.25pF	GQM1885C2A5R0CB01#	
			5.1pF	±0.25pF	GQM1885C2A5R1CB01#	
				±0.5pF	GQM1885C2A5R1DB01#	
			5.6pF	±0.25pF	GQM1885C2A5R6CB01#	
				±0.5pF	GQM1885C2A5R6DB01#	
		6.0pF	±0.25pF	GQM1885C2A6R0CB01#		
			±0.5pF	GQM1885C2A6R0DB01#		
		6.2pF	±0.25pF	GQM1885C2A6R2CB01#		
			±0.5pF	GQM1885C2A6R2DB01#		
		6.8pF	±0.25pF	GQM1885C2A6R8CB01#		
			±0.5pF	GQM1885C2A6R8DB01#		
		50Vdc	CH	7.0pF	±0.25pF	GQM1882C1H7R0CB01#
					±0.5pF	GQM1882C1H7R0DB01#
				7.5pF	±0.25pF	GQM1882C1H7R5CB01#
					±0.5pF	GQM1882C1H7R5DB01#
				8.0pF	±0.25pF	GQM1882C1H8R0CB01#
					±0.5pF	GQM1882C1H8R0DB01#
				8.2pF	±0.25pF	GQM1882C1H8R2CB01#
					±0.5pF	GQM1882C1H8R2DB01#
				9.0pF	±0.25pF	GQM1882C1H9R0CB01#
					±0.5pF	GQM1882C1H9R0DB01#
				9.1pF	±0.25pF	GQM1882C1H9R1CB01#
					±0.5pF	GQM1882C1H9R1DB01#
				10pF	±2%	GQM1882C1H100GB01#
					±5%	GQM1882C1H100JB01#
				11pF	±2%	GQM1882C1H110GB01#
					±5%	GQM1882C1H110JB01#
				12pF	±2%	GQM1882C1H120GB01#
					±5%	GQM1882C1H120JB01#
13pF	±2%			GQM1882C1H130GB01#		
	±5%			GQM1882C1H130JB01#		
15pF	±2%			GQM1882C1H150GB01#		
	±5%			GQM1882C1H150JB01#		
16pF	±2%			GQM1882C1H160GB01#		
	±5%			GQM1882C1H160JB01#		

品番 #には包装仕様コードが入ります。

GRMシリーズ
 GJMシリーズ
 GMAシリーズ
 GMDシリーズ
GQMシリーズ
 GRUシリーズ
 GR3シリーズ
 KRMシリーズ
 KR3シリーズ
 LLAシリーズ
 LLLシリーズ
 LLMシリーズ
 LLRシリーズ
 △注意/
 使用上の注意

GQMシリーズ 温度補償用 High Q 品番表

(→ ■ 1.6×0.8mm)

T寸法 最大値	定格 電圧	温度 特性	静電容量	許容差	品番
0.9mm	50Vdc	CH	18pF	±2%	GQM1882C1H180GB01#
				±5%	GQM1882C1H180JB01#
			20pF	±2%	GQM1882C1H200GB01#
				±5%	GQM1882C1H200JB01#
			22pF	±2%	GQM1882C1H220GB01#
				±5%	GQM1882C1H220JB01#
			24pF	±2%	GQM1882C1H240GB01#
				±5%	GQM1882C1H240JB01#
			27pF	±2%	GQM1882C1H270GB01#
				±5%	GQM1882C1H270JB01#
			30pF	±2%	GQM1882C1H300GB01#
				±5%	GQM1882C1H300JB01#
			33pF	±2%	GQM1882C1H330GB01#
				±5%	GQM1882C1H330JB01#
			36pF	±2%	GQM1882C1H360GB01#
				±5%	GQM1882C1H360JB01#
			39pF	±2%	GQM1882C1H390GB01#
				±5%	GQM1882C1H390JB01#
			43pF	±2%	GQM1882C1H430GB01#
				±5%	GQM1882C1H430JB01#
			47pF	±2%	GQM1882C1H470GB01#
		±5%		GQM1882C1H470JB01#	
		51pF	±2%	GQM1882C1H510GB01#	
			±5%	GQM1882C1H510JB01#	
		56pF	±2%	GQM1882C1H560GB01#	
			±5%	GQM1882C1H560JB01#	
		62pF	±2%	GQM1882C1H620GB01#	
			±5%	GQM1882C1H620JB01#	
		68pF	±2%	GQM1882C1H680GB01#	
			±5%	GQM1882C1H680JB01#	
		75pF	±2%	GQM1882C1H750GB01#	
			±5%	GQM1882C1H750JB01#	
		82pF	±2%	GQM1882C1H820GB01#	
			±5%	GQM1882C1H820JB01#	
		91pF	±2%	GQM1882C1H910GB01#	
			±5%	GQM1882C1H910JB01#	
		100pF	±2%	GQM1882C1H101GB01#	
			±5%	GQM1882C1H101JB01#	
		C0G	7.0pF	±0.25pF	GQM1885C1H7R0CB01#
				±0.5pF	GQM1885C1H7R0DB01#
			7.5pF	±0.25pF	GQM1885C1H7R5CB01#
				±0.5pF	GQM1885C1H7R5DB01#
8.0pF	±0.25pF		GQM1885C1H8R0CB01#		
	±0.5pF		GQM1885C1H8R0DB01#		
8.2pF	±0.25pF		GQM1885C1H8R2CB01#		
	±0.5pF		GQM1885C1H8R2DB01#		
9.0pF	±0.25pF		GQM1885C1H9R0CB01#		
	±0.5pF		GQM1885C1H9R0DB01#		
9.1pF	±0.25pF		GQM1885C1H9R1CB01#		
	±0.5pF		GQM1885C1H9R1DB01#		
10pF	±2%		GQM1885C1H100GB01#		
	±5%		GQM1885C1H100JB01#		
11pF	±2%		GQM1885C1H110GB01#		
	±5%	GQM1885C1H110JB01#			

T寸法 最大値	定格 電圧	温度 特性	静電容量	許容差	品番
0.9mm	50Vdc	C0G	12pF	±2%	GQM1885C1H120GB01#
				±5%	GQM1885C1H120JB01#
			13pF	±2%	GQM1885C1H130GB01#
				±5%	GQM1885C1H130JB01#
			15pF	±2%	GQM1885C1H150GB01#
				±5%	GQM1885C1H150JB01#
			16pF	±2%	GQM1885C1H160GB01#
				±5%	GQM1885C1H160JB01#
			18pF	±2%	GQM1885C1H180GB01#
				±5%	GQM1885C1H180JB01#
			20pF	±2%	GQM1885C1H200GB01#
				±5%	GQM1885C1H200JB01#
			22pF	±2%	GQM1885C1H220GB01#
				±5%	GQM1885C1H220JB01#
			24pF	±2%	GQM1885C1H240GB01#
				±5%	GQM1885C1H240JB01#
			27pF	±2%	GQM1885C1H270GB01#
				±5%	GQM1885C1H270JB01#
			30pF	±2%	GQM1885C1H300GB01#
				±5%	GQM1885C1H300JB01#
			33pF	±2%	GQM1885C1H330GB01#
				±5%	GQM1885C1H330JB01#
			36pF	±2%	GQM1885C1H360GB01#
				±5%	GQM1885C1H360JB01#
			39pF	±2%	GQM1885C1H390GB01#
				±5%	GQM1885C1H390JB01#
			43pF	±2%	GQM1885C1H430GB01#
				±5%	GQM1885C1H430JB01#
			47pF	±2%	GQM1885C1H470GB01#
				±5%	GQM1885C1H470JB01#
			51pF	±2%	GQM1885C1H510GB01#
				±5%	GQM1885C1H510JB01#
			56pF	±2%	GQM1885C1H560GB01#
				±5%	GQM1885C1H560JB01#
			62pF	±2%	GQM1885C1H620GB01#
				±5%	GQM1885C1H620JB01#
			68pF	±2%	GQM1885C1H680GB01#
				±5%	GQM1885C1H680JB01#
			75pF	±2%	GQM1885C1H750GB01#
				±5%	GQM1885C1H750JB01#
			82pF	±2%	GQM1885C1H820GB01#
				±5%	GQM1885C1H820JB01#
91pF	±2%	GQM1885C1H910GB01#			
	±5%	GQM1885C1H910JB01#			
100pF	±2%	GQM1885C1H101GB01#			
	±5%	GQM1885C1H101JB01#			

■ 2.0×1.25mm

T寸法 最大値	定格 電圧	温度 特性	静電容量	許容差	品番
0.95mm	100Vdc	CK	1.0pF	±0.1pF	GQM2194C2A1R0BB01#
				±0.25pF	GQM2194C2A1R0CB01#
			1.1pF	±0.1pF	GQM2194C2A1R1BB01#

品番 #には包装仕様コードが入ります。

GRMシリーズ
GJMシリーズ
GMAシリーズ
GMDシリーズ
GQMシリーズ
GRJシリーズ
GR3シリーズ
KRMシリーズ
KR3シリーズ
LLAシリーズ
LLLシリーズ
LLMシリーズ
LLRシリーズ
△注意/
使用上の注意

GQMシリーズ 温度補償用 **High Q** 品番表

(→ ■2.0×1.25mm)

T寸法 最大値	定格 電圧	温度 特性	静電容量	許容差	品番	
0.95mm	100Vdc	CK	1.1pF	±0.25pF	GQM2194C2A1R1CB01#	
				±0.1pF	GQM2194C2A1R2BB01#	
			1.2pF	±0.25pF	GQM2194C2A1R2CB01#	
				±0.5pF	GQM2194C2A1R2DB01#	
			1.3pF	±0.1pF	GQM2194C2A1R3BB01#	
				±0.25pF	GQM2194C2A1R3CB01#	
			1.5pF	±0.1pF	GQM2194C2A1R5BB01#	
				±0.25pF	GQM2194C2A1R5CB01#	
			1.6pF	±0.1pF	GQM2194C2A1R6BB01#	
				±0.25pF	GQM2194C2A1R6CB01#	
			1.8pF	±0.1pF	GQM2194C2A1R8BB01#	
				±0.25pF	GQM2194C2A1R8CB01#	
			2.0pF	±0.1pF	GQM2194C2A2R0BB01#	
				±0.25pF	GQM2194C2A2R0CB01#	
			CJ	2.2pF	±0.1pF	GQM2193C2A2R2BB01#
					±0.25pF	GQM2193C2A2R2CB01#
				2.4pF	±0.1pF	GQM2193C2A2R4BB01#
					±0.25pF	GQM2193C2A2R4CB01#
		2.7pF		±0.1pF	GQM2193C2A2R7BB01#	
				±0.25pF	GQM2193C2A2R7CB01#	
		3.0pF		±0.1pF	GQM2193C2A3R0BB01#	
				±0.25pF	GQM2193C2A3R0CB01#	
		3.3pF		±0.1pF	GQM2193C2A3R3BB01#	
				±0.25pF	GQM2193C2A3R3CB01#	
		3.6pF		±0.1pF	GQM2193C2A3R6BB01#	
				±0.25pF	GQM2193C2A3R6CB01#	
		3.9pF		±0.1pF	GQM2193C2A3R9BB01#	
				±0.25pF	GQM2193C2A3R9CB01#	
		CH		4.0pF	±0.1pF	GQM2192C2A4R0BB01#
					±0.25pF	GQM2192C2A4R0CB01#
				4.3pF	±0.1pF	GQM2192C2A4R3BB01#
					±0.25pF	GQM2192C2A4R3CB01#
			4.7pF	±0.1pF	GQM2192C2A4R7BB01#	
				±0.25pF	GQM2192C2A4R7CB01#	
			5.0pF	±0.1pF	GQM2192C2A5R0BB01#	
				±0.25pF	GQM2192C2A5R0CB01#	
			5.1pF	±0.25pF	GQM2192C2A5R1CB01#	
				±0.5pF	GQM2192C2A5R1DB01#	
			5.6pF	±0.25pF	GQM2192C2A5R6CB01#	
				±0.5pF	GQM2192C2A5R6DB01#	
			6.0pF	±0.25pF	GQM2192C2A6R0CB01#	
				±0.5pF	GQM2192C2A6R0DB01#	
			6.2pF	±0.25pF	GQM2192C2A6R2CB01#	
				±0.5pF	GQM2192C2A6R2DB01#	
			6.8pF	±0.25pF	GQM2192C2A6R8CB01#	
				±0.5pF	GQM2192C2A6R8DB01#	
		7.0pF	±0.25pF	GQM2192C2A7R0CB01#		
			±0.5pF	GQM2192C2A7R0DB01#		
		7.5pF	±0.25pF	GQM2192C2A7R5CB01#		
			±0.5pF	GQM2192C2A7R5DB01#		
		8.0pF	±0.25pF	GQM2192C2A8R0CB01#		
			±0.5pF	GQM2192C2A8R0DB01#		
		8.2pF	±0.25pF	GQM2192C2A8R2CB01#		
			±0.5pF	GQM2192C2A8R2DB01#		
9.0pF	±0.25pF	GQM2192C2A9R0CB01#				

T寸法 最大値	定格 電圧	温度 特性	静電容量	許容差	品番
0.95mm	100Vdc	CH	9.0pF	±0.5pF	GQM2192C2A9R0DB01#
				±0.25pF	GQM2192C2A9R1CB01#
			9.1pF	±0.5pF	GQM2192C2A9R1DB01#
				±2%	GQM2192C2A100GB01#
			10pF	±5%	GQM2192C2A100JB01#
				±2%	GQM2192C2A110GB01#
			11pF	±5%	GQM2192C2A110JB01#
				±2%	GQM2192C2A120GB01#
			12pF	±5%	GQM2192C2A120JB01#
				±2%	GQM2192C2A130GB01#
			13pF	±5%	GQM2192C2A130JB01#
				±2%	GQM2192C2A150GB01#
			15pF	±5%	GQM2192C2A150JB01#
				±2%	GQM2192C2A160GB01#
			16pF	±5%	GQM2192C2A160JB01#
				±2%	GQM2192C2A180GB01#
			18pF	±5%	GQM2192C2A180JB01#
				COG	1.0pF
		±0.25pF	GQM2195C2A1R0CB01#		
		1.1pF	±0.1pF		GQM2195C2A1R1BB01#
			±0.25pF		GQM2195C2A1R1CB01#
		1.2pF	±0.1pF		GQM2195C2A1R2BB01#
			±0.25pF		GQM2195C2A1R2CB01#
		1.3pF	±0.1pF		GQM2195C2A1R3BB01#
			±0.25pF		GQM2195C2A1R3CB01#
		1.5pF	±0.1pF		GQM2195C2A1R5BB01#
			±0.25pF		GQM2195C2A1R5CB01#
		1.6pF	±0.1pF		GQM2195C2A1R6BB01#
			±0.25pF		GQM2195C2A1R6CB01#
		1.8pF	±0.1pF		GQM2195C2A1R8BB01#
			±0.25pF		GQM2195C2A1R8CB01#
		2.0pF	±0.1pF		GQM2195C2A2R0BB01#
			±0.25pF		GQM2195C2A2R0CB01#
		2.2pF	±0.1pF		GQM2195C2A2R2BB01#
			±0.25pF		GQM2195C2A2R2CB01#
		2.4pF	±0.1pF	GQM2195C2A2R4BB01#	
			±0.25pF	GQM2195C2A2R4CB01#	
		2.7pF	±0.1pF	GQM2195C2A2R7BB01#	
			±0.25pF	GQM2195C2A2R7CB01#	
		3.0pF	±0.1pF	GQM2195C2A3R0BB01#	
			±0.25pF	GQM2195C2A3R0CB01#	
		3.3pF	±0.1pF	GQM2195C2A3R3BB01#	
			±0.25pF	GQM2195C2A3R3CB01#	
		3.6pF	±0.1pF	GQM2195C2A3R6BB01#	
			±0.25pF	GQM2195C2A3R6CB01#	
		3.9pF	±0.1pF	GQM2195C2A3R9BB01#	
			±0.25pF	GQM2195C2A3R9CB01#	
		4.0pF	±0.1pF	GQM2195C2A4R0BB01#	
			±0.25pF	GQM2195C2A4R0CB01#	
		4.3pF	±0.1pF	GQM2195C2A4R3BB01#	
			±0.25pF	GQM2195C2A4R3CB01#	
		4.7pF	±0.1pF	GQM2195C2A4R7BB01#	
			±0.25pF	GQM2195C2A4R7CB01#	
		5.0pF	±0.1pF	GQM2195C2A5R0BB01#	
±0.25pF	GQM2195C2A5R0CB01#				
5.1pF	±0.25pF	GQM2195C2A5R1CB01#			
	±0.5pF	GQM2195C2A5R1DB01#			
5.6pF	±0.25pF	GQM2195C2A5R6CB01#			
	±0.5pF	GQM2195C2A5R6DB01#			
6.0pF	±0.25pF	GQM2195C2A6R0CB01#			
	±0.5pF	GQM2195C2A6R0DB01#			
6.2pF	±0.25pF	GQM2195C2A6R2CB01#			
	±0.5pF	GQM2195C2A6R2DB01#			
6.8pF	±0.25pF	GQM2195C2A6R8CB01#			
	±0.5pF	GQM2195C2A6R8DB01#			
7.0pF	±0.25pF	GQM2195C2A7R0CB01#			
	±0.5pF	GQM2195C2A7R0DB01#			
7.5pF	±0.25pF	GQM2195C2A7R5CB01#			
	±0.5pF	GQM2195C2A7R5DB01#			
8.0pF	±0.25pF	GQM2195C2A8R0CB01#			
	±0.5pF	GQM2195C2A8R0DB01#			
8.2pF	±0.25pF	GQM2195C2A8R2CB01#			
	±0.5pF	GQM2195C2A8R2DB01#			
9.0pF	±0.1pF	GQM2195C2A9R0BB01#			

品番 #には包装仕様コードが入ります。

GRMシリーズ
 GJMシリーズ
 GMAシリーズ
 GMDシリーズ
GQMシリーズ
 GRJシリーズ
 GR3シリーズ
 KRMシリーズ
 KR3シリーズ
 LLAシリーズ
 LLLシリーズ
 LLMシリーズ
 LLRシリーズ
 △注意/
 使用上の注意

GQMシリーズ 温度補償用 High Q 品番表

(→ ■2.0×1.25mm)

T寸法 最大値	定格 電圧	温度 特性	静電容量	許容差	品番	T寸法 最大値	定格 電圧	温度 特性	静電容量	許容差	品番
0.95mm	100Vdc	C0G	5.0pF	±0.25pF	GQM2195C2A5R0CB01#	0.95mm	50Vdc	CH	43pF	±5%	GQM2192C1H430JB01#
				±0.25pF	GQM2195C2A5R1CB01#					±2%	GQM2192C1H470GB01#
			5.1pF	±0.5pF	GQM2195C2A5R1DB01#	±5%			GQM2192C1H470JB01#		
				5.6pF	±0.25pF	GQM2195C2A5R6CB01#			±2%	GQM2192C1H510GB01#	
			±0.5pF		GQM2195C2A5R6DB01#	±5%			GQM2192C1H510JB01#		
			6.0pF	±0.25pF	GQM2195C2A6R0CB01#	±2%			GQM2192C1H560GB01#		
				±0.5pF	GQM2195C2A6R0DB01#	±5%			GQM2192C1H560JB01#		
			6.2pF	±0.25pF	GQM2195C2A6R2CB01#	±2%			GQM2192C1H620GB01#		
				±0.5pF	GQM2195C2A6R2DB01#	±5%			GQM2192C1H620JB01#		
			6.8pF	±0.25pF	GQM2195C2A6R8CB01#	±2%			GQM2192C1H680GB01#		
				±0.5pF	GQM2195C2A6R8DB01#	±5%			GQM2192C1H680JB01#		
			7.0pF	±0.25pF	GQM2195C2A7R0CB01#	±2%			GQM2192C1H750GB01#		
				±0.5pF	GQM2195C2A7R0DB01#	±5%			GQM2192C1H750JB01#		
			7.5pF	±0.25pF	GQM2195C2A7R5CB01#	±2%			GQM2192C1H820GB01#		
				±0.5pF	GQM2195C2A7R5DB01#	±5%			GQM2192C1H820JB01#		
			8.0pF	±0.25pF	GQM2195C2A8R0CB01#	±2%			GQM2192C1H910GB01#		
				±0.5pF	GQM2195C2A8R0DB01#	±5%			GQM2192C1H910JB01#		
			8.2pF	±0.25pF	GQM2195C2A8R2CB01#	±2%			GQM2192C1H101GB01#		
				±0.5pF	GQM2195C2A8R2DB01#	±5%			GQM2192C1H101JB01#		
			9.0pF	±0.25pF	GQM2195C2A9R0CB01#	±2%			GQM2195C1H200GB01#		
				±0.5pF	GQM2195C2A9R0DB01#	±5%			GQM2195C1H200JB01#		
	9.1pF	±0.25pF	GQM2195C2A9R1CB01#	±2%	GQM2195C1H220GB01#						
		±0.5pF	GQM2195C2A9R1DB01#	±5%	GQM2195C1H220JB01#						
	10pF	±2%	GQM2195C2A100GB01#	±2%	GQM2195C1H240GB01#						
		±5%	GQM2195C2A100JB01#	±5%	GQM2195C1H240JB01#						
	11pF	±2%	GQM2195C2A110GB01#	±2%	GQM2195C1H270GB01#						
		±5%	GQM2195C2A110JB01#	±5%	GQM2195C1H270JB01#						
	12pF	±2%	GQM2195C2A120GB01#	±2%	GQM2195C1H300GB01#						
		±5%	GQM2195C2A120JB01#	±5%	GQM2195C1H300JB01#						
	13pF	±2%	GQM2195C2A130GB01#	±2%	GQM2195C1H330GB01#						
		±5%	GQM2195C2A130JB01#	±5%	GQM2195C1H330JB01#						
	15pF	±2%	GQM2195C2A150GB01#	±2%	GQM2195C1H360GB01#						
		±5%	GQM2195C2A150JB01#	±5%	GQM2195C1H360JB01#						
	16pF	±2%	GQM2195C2A160GB01#	±2%	GQM2195C1H390GB01#						
		±5%	GQM2195C2A160JB01#	±5%	GQM2195C1H390JB01#						
	18pF	±2%	GQM2195C2A180GB01#	±2%	GQM2195C1H430GB01#						
		±5%	GQM2195C2A180JB01#	±5%	GQM2195C1H430JB01#						
	50Vdc	CH	20pF	±2%	GQM2192C1H200GB01#	0.95mm	50Vdc	C0G	20pF	±2%	GQM2195C1H101GB01#
				±5%	GQM2192C1H200JB01#					±5%	GQM2195C1H101JB01#
			22pF	±2%	GQM2192C1H220GB01#	22pF			±2%	GQM2195C1H120GB01#	
				±5%	GQM2192C1H220JB01#				±5%	GQM2195C1H120JB01#	
			24pF	±2%	GQM2192C1H240GB01#	24pF			±2%	GQM2195C1H240GB01#	
±5%				GQM2192C1H240JB01#	±5%				GQM2195C1H240JB01#		
27pF			±2%	GQM2192C1H270GB01#	27pF	±2%			GQM2195C1H270GB01#		
			±5%	GQM2192C1H270JB01#		±5%			GQM2195C1H270JB01#		
30pF			±2%	GQM2192C1H300GB01#	30pF	±2%			GQM2195C1H300GB01#		
			±5%	GQM2192C1H300JB01#		±5%			GQM2195C1H300JB01#		
33pF			±2%	GQM2192C1H330GB01#	33pF	±2%			GQM2195C1H330GB01#		
			±5%	GQM2192C1H330JB01#		±5%			GQM2195C1H330JB01#		
36pF			±2%	GQM2192C1H360GB01#	36pF	±2%			GQM2195C1H360GB01#		
			±5%	GQM2192C1H360JB01#		±5%			GQM2195C1H360JB01#		
39pF			±2%	GQM2192C1H390GB01#	39pF	±2%			GQM2195C1H390GB01#		
	±5%	GQM2192C1H390JB01#	±5%	GQM2195C1H390JB01#							
43pF	±2%	GQM2192C1H430GB01#	43pF	±2%	GQM2195C1H430GB01#						
	±5%	GQM2192C1H430JB01#		±5%	GQM2195C1H430JB01#						
47pF	±2%	GQM2192C1H470GB01#	47pF	±2%	GQM2195C1H470GB01#						
	±5%	GQM2192C1H470JB01#		±5%	GQM2195C1H470JB01#						
51pF	±2%	GQM2192C1H510GB01#	51pF	±2%	GQM2195C1H510GB01#						
	±5%	GQM2192C1H510JB01#		±5%	GQM2195C1H510JB01#						
56pF	±2%	GQM2192C1H560GB01#	56pF	±2%	GQM2195C1H560GB01#						
	±5%	GQM2192C1H560JB01#		±5%	GQM2195C1H560JB01#						
62pF	±2%	GQM2192C1H620GB01#	62pF	±2%	GQM2195C1H620GB01#						
	±5%	GQM2192C1H620JB01#		±5%	GQM2195C1H620JB01#						
68pF	±2%	GQM2192C1H680GB01#	68pF	±2%	GQM2195C1H680GB01#						
	±5%	GQM2192C1H680JB01#		±5%	GQM2195C1H680JB01#						
75pF	±2%	GQM2192C1H750GB01#	75pF	±2%	GQM2195C1H750GB01#						
	±5%	GQM2192C1H750JB01#		±5%	GQM2195C1H750JB01#						
82pF	±2%	GQM2192C1H820GB01#	82pF	±2%	GQM2195C1H820GB01#						
	±5%	GQM2192C1H820JB01#		±5%	GQM2195C1H820JB01#						
91pF	±2%	GQM2192C1H910GB01#	91pF	±2%	GQM2195C1H910GB01#						
	±5%	GQM2192C1H910JB01#		±5%	GQM2195C1H910JB01#						
100pF	±2%	GQM2192C1H101GB01#	100pF	±2%	GQM2195C1H101GB01#						
	±5%	GQM2192C1H101JB01#		±5%	GQM2195C1H101JB01#						

品番 #には包装仕様コードが入ります。

GRMシリーズ
GJMシリーズ
GMAシリーズ
GMDシリーズ
GQMシリーズ
GRJシリーズ
GR3シリーズ
KRMシリーズ
KR3シリーズ
LLAシリーズ
LLLシリーズ
LLMシリーズ
LLRシリーズ
△注意/
使用上の注意

GQMシリーズ 温度補償用 **High Q** 品番表

(→ ■2.0×1.25mm)

T寸法 最大値	定格 電圧	温度 特性	静電容量	許容差	品番
0.95mm	50Vdc	C0G	100pF	±5%	GQM2195C1H101JB01#
1.0mm	250Vdc	C0G	1.0pF	±0.1pF	GQM2195C2E1R0BB12#
				±0.25pF	GQM2195C2E1R0CB12#
			1.1pF	±0.1pF	GQM2195C2E1R1BB12#
				±0.25pF	GQM2195C2E1R1CB12#
			1.2pF	±0.1pF	GQM2195C2E1R2BB12#
				±0.25pF	GQM2195C2E1R2CB12#
			1.3pF	±0.1pF	GQM2195C2E1R3BB12#
				±0.25pF	GQM2195C2E1R3CB12#
			1.5pF	±0.1pF	GQM2195C2E1R5BB12#
				±0.25pF	GQM2195C2E1R5CB12#
			1.6pF	±0.1pF	GQM2195C2E1R6BB12#
				±0.25pF	GQM2195C2E1R6CB12#
			1.8pF	±0.1pF	GQM2195C2E1R8BB12#
				±0.25pF	GQM2195C2E1R8CB12#
			2.0pF	±0.1pF	GQM2195C2E2R0BB12#
				±0.25pF	GQM2195C2E2R0CB12#
			2.2pF	±0.1pF	GQM2195C2E2R2BB12#
				±0.25pF	GQM2195C2E2R2CB12#
			2.4pF	±0.1pF	GQM2195C2E2R4BB12#
				±0.25pF	GQM2195C2E2R4CB12#
			2.7pF	±0.1pF	GQM2195C2E2R7BB12#
				±0.25pF	GQM2195C2E2R7CB12#
			3.0pF	±0.1pF	GQM2195C2E3R0BB12#
				±0.25pF	GQM2195C2E3R0CB12#
			3.3pF	±0.1pF	GQM2195C2E3R3BB12#
				±0.25pF	GQM2195C2E3R3CB12#
			3.6pF	±0.1pF	GQM2195C2E3R6BB12#
				±0.25pF	GQM2195C2E3R6CB12#
			3.9pF	±0.1pF	GQM2195C2E3R9BB12#
				±0.25pF	GQM2195C2E3R9CB12#
			4.0pF	±0.1pF	GQM2195C2E4R0BB12#
				±0.25pF	GQM2195C2E4R0CB12#
			4.3pF	±0.1pF	GQM2195C2E4R3BB12#
				±0.25pF	GQM2195C2E4R3CB12#
			4.7pF	±0.1pF	GQM2195C2E4R7BB12#
				±0.25pF	GQM2195C2E4R7CB12#
			5.0pF	±0.1pF	GQM2195C2E5R0BB12#
				±0.25pF	GQM2195C2E5R0CB12#
			5.1pF	±0.25pF	GQM2195C2E5R1CB12#
				±0.5pF	GQM2195C2E5R1DB12#
5.6pF	±0.25pF	GQM2195C2E5R6CB12#			
	±0.5pF	GQM2195C2E5R6DB12#			
6.0pF	±0.25pF	GQM2195C2E6R0CB12#			
	±0.5pF	GQM2195C2E6R0DB12#			
6.2pF	±0.25pF	GQM2195C2E6R2CB12#			
	±0.5pF	GQM2195C2E6R2DB12#			
6.8pF	±0.25pF	GQM2195C2E6R8CB12#			
	±0.5pF	GQM2195C2E6R8DB12#			
7.0pF	±0.25pF	GQM2195C2E7R0CB12#			
	±0.5pF	GQM2195C2E7R0DB12#			
7.5pF	±0.25pF	GQM2195C2E7R5CB12#			
	±0.5pF	GQM2195C2E7R5DB12#			
8.0pF	±0.25pF	GQM2195C2E8R0CB12#			

T寸法 最大値	定格 電圧	温度 特性	静電容量	許容差	品番
1.0mm	250Vdc	C0G	8.0pF	±0.5pF	GQM2195C2E8R0DB12#
			8.2pF	±0.25pF	GQM2195C2E8R2CB12#
				±0.5pF	GQM2195C2E8R2DB12#
			9.0pF	±0.25pF	GQM2195C2E9R0CB12#
				±0.5pF	GQM2195C2E9R0DB12#
			9.1pF	±0.25pF	GQM2195C2E9R1CB12#
				±0.5pF	GQM2195C2E9R1DB12#
			10pF	±2%	GQM2195C2E100GB12#
				±5%	GQM2195C2E100JB12#
			11pF	±2%	GQM2195C2E110GB12#
				±5%	GQM2195C2E110JB12#
			12pF	±2%	GQM2195C2E120GB12#
				±5%	GQM2195C2E120JB12#
			13pF	±2%	GQM2195C2E130GB12#
				±5%	GQM2195C2E130JB12#
			15pF	±2%	GQM2195C2E150GB12#
				±5%	GQM2195C2E150JB12#
			16pF	±2%	GQM2195C2E160GB12#
				±5%	GQM2195C2E160JB12#
			18pF	±2%	GQM2195C2E180GB12#
				±5%	GQM2195C2E180JB12#
			20pF	±2%	GQM2195C2E200GB12#
				±5%	GQM2195C2E200JB12#
			22pF	±2%	GQM2195C2E220GB12#
±5%	GQM2195C2E220JB12#				
24pF	±2%	GQM2195C2E240GB12#			
	±5%	GQM2195C2E240JB12#			
27pF	±2%	GQM2195C2E270GB12#			
	±5%	GQM2195C2E270JB12#			
30pF	±2%	GQM2195C2E300GB12#			
	±5%	GQM2195C2E300JB12#			
33pF	±2%	GQM2195C2E330GB12#			
	±5%	GQM2195C2E330JB12#			
36pF	±2%	GQM2195C2E360GB12#			
	±5%	GQM2195C2E360JB12#			
39pF	±2%	GQM2195C2E390GB12#			
	±5%	GQM2195C2E390JB12#			
43pF	±2%	GQM2195C2E430GB12#			
	±5%	GQM2195C2E430JB12#			
47pF	±2%	GQM2195C2E470GB12#			
	±5%	GQM2195C2E470JB12#			
51pF	±2%	GQM2195C2E510GB12#			
	±5%	GQM2195C2E510JB12#			
56pF	±2%	GQM2195C2E560GB12#			
	±5%	GQM2195C2E560JB12#			
62pF	±2%	GQM2195C2E620GB12#			
	±5%	GQM2195C2E620JB12#			
68pF	±2%	GQM2195C2E680GB12#			
	±5%	GQM2195C2E680JB12#			
75pF	±2%	GQM2195C2E750GB12#			
	±5%	GQM2195C2E750JB12#			
82pF	±2%	GQM2195C2E820GB12#			
	±5%	GQM2195C2E820JB12#			
91pF	±2%	GQM2195C2E910GB12#			

品番 #には包装仕様コードが入ります。

GRMシリーズ
 GJMシリーズ
 GMAシリーズ
 GMDシリーズ
GQMシリーズ
 GRJシリーズ
 GR3シリーズ
 KRMシリーズ
 KR3シリーズ
 LLAシリーズ
 LLLシリーズ
 LLMシリーズ
 LLRシリーズ
 △注意/
 使用上の注意

GQMシリーズ 温度補償用 High Q 品番表

(→ ■2.0×1.25mm)

T寸法 最大値	定格 電圧	温度 特性	静電容量	許容差	品番
1.0mm	250Vdc	COG	91pF	±5%	GQM2195C2E910JB12#
				±2%	GQM2195C2E101GB12#
				±5%	GQM2195C2E101JB12#

T寸法 最大値	定格 電圧	温度 特性	静電容量	許容差	品番
1.35mm	500Vdc	COG	6.8pF	±0.25pF	GQM22M5C2H6R8CB01#
				±0.5pF	GQM22M5C2H6R8DB01#
			7.0pF	±0.25pF	GQM22M5C2H7R0CB01#
				±0.5pF	GQM22M5C2H7R0DB01#
			7.5pF	±0.25pF	GQM22M5C2H7R5CB01#
				±0.5pF	GQM22M5C2H7R5DB01#
			8.0pF	±0.25pF	GQM22M5C2H8R0CB01#
				±0.5pF	GQM22M5C2H8R0DB01#
			8.2pF	±0.25pF	GQM22M5C2H8R2CB01#
				±0.5pF	GQM22M5C2H8R2DB01#
			9.0pF	±0.25pF	GQM22M5C2H9R0CB01#
				±0.5pF	GQM22M5C2H9R0DB01#
			9.1pF	±0.25pF	GQM22M5C2H9R1CB01#
				±0.5pF	GQM22M5C2H9R1DB01#
			10pF	±2%	GQM22M5C2H100GB01#
				±5%	GQM22M5C2H100JB01#
			11pF	±2%	GQM22M5C2H110GB01#
				±5%	GQM22M5C2H110JB01#
			12pF	±2%	GQM22M5C2H120GB01#
				±5%	GQM22M5C2H120JB01#
			13pF	±2%	GQM22M5C2H130GB01#
				±5%	GQM22M5C2H130JB01#
			15pF	±2%	GQM22M5C2H150GB01#
				±5%	GQM22M5C2H150JB01#
			16pF	±2%	GQM22M5C2H160GB01#
				±5%	GQM22M5C2H160JB01#
			18pF	±2%	GQM22M5C2H180GB01#
				±5%	GQM22M5C2H180JB01#
			20pF	±2%	GQM22M5C2H200GB01#
±5%	GQM22M5C2H200JB01#				
22pF	±2%	GQM22M5C2H220GB01#			
	±5%	GQM22M5C2H220JB01#			
24pF	±2%	GQM22M5C2H240GB01#			
	±5%	GQM22M5C2H240JB01#			
27pF	±2%	GQM22M5C2H270GB01#			
	±5%	GQM22M5C2H270JB01#			
30pF	±2%	GQM22M5C2H300GB01#			
	±5%	GQM22M5C2H300JB01#			
33pF	±2%	GQM22M5C2H330GB01#			
	±5%	GQM22M5C2H330JB01#			
36pF	±2%	GQM22M5C2H360GB01#			
	±5%	GQM22M5C2H360JB01#			
39pF	±2%	GQM22M5C2H390GB01#			
	±5%	GQM22M5C2H390JB01#			
43pF	±2%	GQM22M5C2H430GB01#			
	±5%	GQM22M5C2H430JB01#			
47pF	±2%	GQM22M5C2H470GB01#			
	±5%	GQM22M5C2H470JB01#			
51pF	±2%	GQM22M5C2H510GB01#			
	±5%	GQM22M5C2H510JB01#			
56pF	±2%	GQM22M5C2H560GB01#			
	±5%	GQM22M5C2H560JB01#			
62pF	±2%	GQM22M5C2H620GB01#			
	±5%	GQM22M5C2H620JB01#			

■2.8×2.8mm

T寸法 最大値	定格 電圧	温度 特性	静電容量	許容差	品番
1.35mm	500Vdc	COG	1.0pF	±0.1pF	GQM22M5C2H1R0BB01#
				±0.25pF	GQM22M5C2H1R0CB01#
			1.1pF	±0.1pF	GQM22M5C2H1R1BB01#
				±0.25pF	GQM22M5C2H1R1CB01#
			1.2pF	±0.1pF	GQM22M5C2H1R2BB01#
				±0.25pF	GQM22M5C2H1R2CB01#
			1.3pF	±0.1pF	GQM22M5C2H1R3BB01#
				±0.25pF	GQM22M5C2H1R3CB01#
			1.5pF	±0.1pF	GQM22M5C2H1R5BB01#
				±0.25pF	GQM22M5C2H1R5CB01#
			1.6pF	±0.1pF	GQM22M5C2H1R6BB01#
				±0.25pF	GQM22M5C2H1R6CB01#
			1.8pF	±0.1pF	GQM22M5C2H1R8BB01#
				±0.25pF	GQM22M5C2H1R8CB01#
			2.0pF	±0.1pF	GQM22M5C2H2R0BB01#
				±0.25pF	GQM22M5C2H2R0CB01#
			2.2pF	±0.1pF	GQM22M5C2H2R2BB01#
				±0.25pF	GQM22M5C2H2R2CB01#
			2.4pF	±0.1pF	GQM22M5C2H2R4BB01#
				±0.25pF	GQM22M5C2H2R4CB01#
			2.7pF	±0.1pF	GQM22M5C2H2R7BB01#
				±0.25pF	GQM22M5C2H2R7CB01#
			3.0pF	±0.1pF	GQM22M5C2H3R0BB01#
				±0.25pF	GQM22M5C2H3R0CB01#
			3.3pF	±0.1pF	GQM22M5C2H3R3BB01#
				±0.25pF	GQM22M5C2H3R3CB01#
			3.6pF	±0.1pF	GQM22M5C2H3R6BB01#
				±0.25pF	GQM22M5C2H3R6CB01#
			3.9pF	±0.1pF	GQM22M5C2H3R9BB01#
				±0.25pF	GQM22M5C2H3R9CB01#
			4.0pF	±0.1pF	GQM22M5C2H4R0BB01#
				±0.25pF	GQM22M5C2H4R0CB01#
			4.3pF	±0.1pF	GQM22M5C2H4R3BB01#
				±0.25pF	GQM22M5C2H4R3CB01#
			4.7pF	±0.1pF	GQM22M5C2H4R7BB01#
				±0.25pF	GQM22M5C2H4R7CB01#
			5.0pF	±0.1pF	GQM22M5C2H5R0BB01#
				±0.25pF	GQM22M5C2H5R0CB01#
			5.1pF	±0.25pF	GQM22M5C2H5R1CB01#
				±0.5pF	GQM22M5C2H5R1DB01#
			5.6pF	±0.25pF	GQM22M5C2H5R6CB01#
				±0.5pF	GQM22M5C2H5R6DB01#
			6.0pF	±0.25pF	GQM22M5C2H6R0CB01#
				±0.5pF	GQM22M5C2H6R0DB01#
			6.2pF	±0.25pF	GQM22M5C2H6R2CB01#
±0.5pF	GQM22M5C2H6R2DB01#				

品番 #には包装仕様コードが入ります。

GRMシリーズ
GJMシリーズ
GMAシリーズ
GMDシリーズ
GQMシリーズ
GRJシリーズ
GR3シリーズ
KRMシリーズ
KR3シリーズ
LLAシリーズ
LLMシリーズ
LLRシリーズ
△注意/
使用上の注意

GQMシリーズ 温度補償用 **High Q** 品番表

(→ ■2.8×2.8mm)

T寸法 最大値	定格 電圧	温度 特性	静電容量	許容差	品番
1.35mm	500Vdc	C0G	68pF	±2%	GQM22M5C2H680GB01#
				±5%	GQM22M5C2H680JB01#
			75pF	±2%	GQM22M5C2H750GB01#
				±5%	GQM22M5C2H750JB01#
			82pF	±2%	GQM22M5C2H820GB01#
				±5%	GQM22M5C2H820JB01#
			91pF	±2%	GQM22M5C2H910GB01#
				±5%	GQM22M5C2H910JB01#
			100pF	±2%	GQM22M5C2H101GB01#
				±5%	GQM22M5C2H101JB01#

GRMシリーズ

GJMシリーズ

GMAシリーズ

GMDシリーズ

GQMシリーズ

GRJシリーズ

GR3シリーズ

KRMシリーズ

KR3シリーズ

LLAシリーズ

LLLシリーズ

LLMシリーズ

LLRシリーズ

△注意/
使用上の注意

樹脂外部電極品

GRJシリーズ  たわみクラック

樹脂外部電極により基板実装後のたわみ応力によるクラックの発生を防止！

特徴

① 樹脂外部電極により、基板たわみでのクラックを抑制。

外部電極の樹脂が応力を開放することで、セラミック素体へのクラックを抑制します。

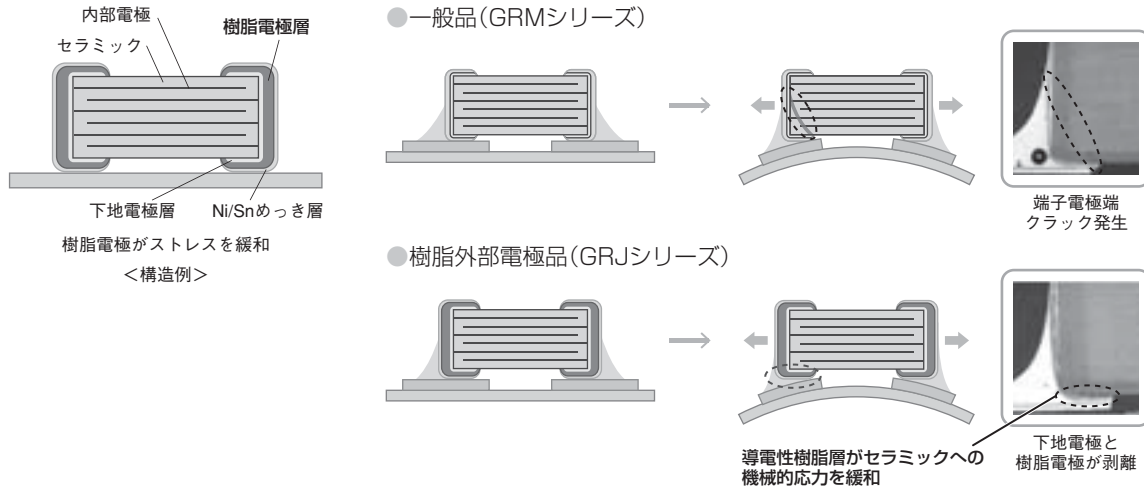

② 基板実装時等のたわみ応力によるクラックの発生を抑制。

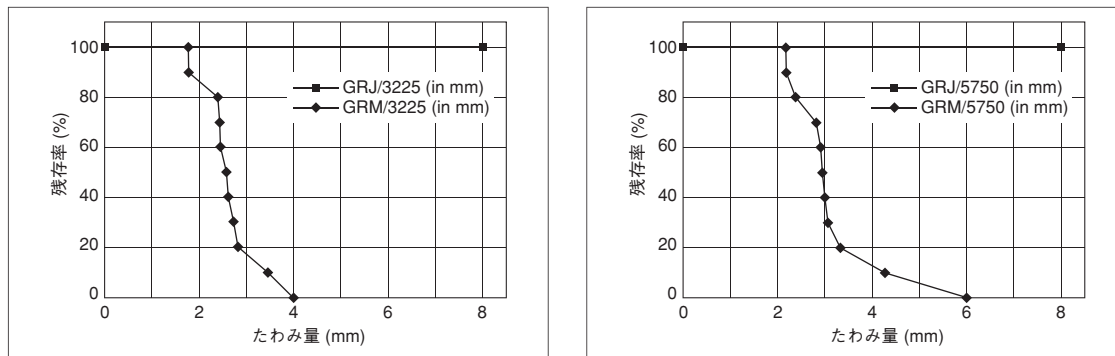

※測定器の仕様により8mmまでの測定となっております。

③ 熱ストレスや振動・衝撃がかかるような民生・産業電子機器などに最適。

主な仕様

サイズ	2.0×1.25mm~5.7×5.0mm
定格電圧	DC6.3V~1kV
静電容量	470pF~47μF
主な用途	民生・産業電子機器

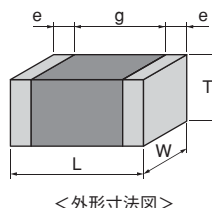

<外形寸法図>

当カタログに掲載している製品は一部です。
 詳しくはWebサイトのコンデンサ検索ページをご参照ください。

GRJシリーズ 高誘電率系 品番表

■2.0×1.25mm

T寸法 最大値	定格 電圧	温度 特性	静電容量	許容差	品番
1.0mm	250Vdc	X7R	1000pF	±10%	GRJ21AR72E102KWJ1#
			1500pF	±10%	GRJ21AR72E152KWJ1#
			2200pF	±10%	GRJ21AR72E222KWJ1#
			3300pF	±10%	GRJ21AR72E332KWJ1#
			4700pF	±10%	GRJ21AR72E472KWJ1#
			6800pF	±10%	GRJ21AR72E682KWJ1#
1.45mm	250Vdc	X7R	10000pF	±10%	GRJ21BR72E103KWJ3#
			15000pF	±10%	GRJ21BR72E153KWJ3#
			22000pF	±10%	GRJ21BR72E223KWJ3#

■3.2×1.6mm

T寸法 最大値	定格 電圧	温度 特性	静電容量	許容差	品番
1.25mm	1000Vdc	X7R	470pF	±10%	GRJ31BR73A471KWJ1#
			680pF	±10%	GRJ31BR73A681KWJ1#
			1000pF	±10%	GRJ31BR73A102KWJ1#
			1500pF	±10%	GRJ31BR73A152KWJ1#
			2200pF	±10%	GRJ31BR73A222KWJ1#
			3300pF	±10%	GRJ31BR73A332KWJ1#
			4700pF	±10%	GRJ31BR73A472KWJ1#
	630Vdc	X7R	1000pF	±10%	GRJ31BR72J102KWJ1#
			1500pF	±10%	GRJ31BR72J152KWJ1#
			2200pF	±10%	GRJ31BR72J222KWJ1#
			3300pF	±10%	GRJ31BR72J332KWJ1#
			4700pF	±10%	GRJ31BR72J472KWJ1#
			6800pF	±10%	GRJ31BR72J682KWJ1#
			10000pF	±10%	GRJ31BR72J103KWJ1#
250Vdc	X7R	15000pF	±10%	GRJ31BR72E153KWJ1#	
		22000pF	±10%	GRJ31BR72E223KWJ1#	
		68000pF	±10%	GRJ31BR72E683KWJ1#	
1.8mm	1000Vdc	X7R	6800pF	±10%	GRJ31CR73A682KWJ3#
			10000pF	±10%	GRJ31CR73A103KWJ3#
	630Vdc	X7R	15000pF	±10%	GRJ31CR72J153KWJ3#
			22000pF	±10%	GRJ31CR72J223KWJ3#
			33000pF	±10%	GRJ31CR72E333KWJ3#
	250Vdc	X7R	47000pF	±10%	GRJ31CR72E473KWJ3#
			0.10μF	±10%	GRJ31CR72E104KWJ3#

■3.2×2.5mm

T寸法 最大値	定格 電圧	温度 特性	静電容量	許容差	品番		
1.5mm	1000Vdc	X7R	6800pF	±10%	GRJ32QR73A682KWJ1#		
			10000pF	±10%	GRJ32QR73A103KWJ1#		
	630Vdc	X7R	22000pF	±10%	GRJ32QR72J223KWJ1#		
			250Vdc	X7R	68000pF	±10%	GRJ32QR72E683KWJ1#
					0.15μF	±10%	GRJ32QR72E154KWJ1#
2.0mm	1000Vdc	X7R	15000pF	±10%	GRJ32DR73A153KWJ1#		
			22000pF	±10%	GRJ32DR73A223KWJ1#		
	630Vdc	X7R	33000pF	±10%	GRJ32DR72J333KWJ1#		
			47000pF	±10%	GRJ32DR72J473KWJ1#		

T寸法 最大値	定格 電圧	温度 特性	静電容量	許容差	品番		
2.0mm	250Vdc	X7R	0.10μF	±10%	GRJ32DR72E104KWJ1#		
			0.22μF	±10%	GRJ32DR72E224KWJ1#		
2.3mm	100Vdc	X7R	2.2μF	±10%	GRJ32DR72A225KE11#		
				±20%	GRJ32DR72A225ME11#		
2.8mm	50Vdc	X7R	4.7μF	±10%	GRJ32ER71H475KE11#		
				±20%	GRJ32ER71H475ME11#		
			10μF	±10%	GRJ32EC71H106KE11#		
				±20%	GRJ32EC71H106ME11#		
	25Vdc	X7R	10μF	±10%	GRJ32ER71E106KE11#		
				±20%	GRJ32ER71E106ME11#		
	16Vdc	X7R	22μF	±10%	GRJ32ER71C226KE11#		
				±20%	GRJ32ER71C226ME11#		
	10Vdc	X7R	22μF	±10%	GRJ32ER71A226KE11#		
±20%				GRJ32ER71A226ME11#			
6.3Vdc				X7R	47μF	±10%	GRJ32ER70J476KE11#
						±20%	GRJ32ER70J476ME11#

■4.5×3.2mm

T寸法 最大値	定格 電圧	温度 特性	静電容量	許容差	品番
1.5mm	630Vdc	X7R	68000pF	±10%	GRJ43QR72J683KWJ1#
	250Vdc	X7R	0.15μF	±10%	GRJ43QR72E154KWJ1#
2.0mm	1000Vdc	X7R	33000pF	±10%	GRJ43DR73A333KWJ1#
			47000pF	±10%	GRJ43DR73A473KWJ1#
	630Vdc	X7R	0.10μF	±10%	GRJ43DR72J104KWJ1#
				±10%	GRJ43DR72E224KWJ1#
	250Vdc	X7R	0.22μF	±10%	GRJ43DR72E224KWJ1#
				0.33μF	±10%
			0.47μF	±10%	GRJ43DR72E474KWJ1#

■5.7×5.0mm

T寸法 最大値	定格 電圧	温度 特性	静電容量	許容差	品番	
2.0mm	1000Vdc	X7R	68000pF	±10%	GRJ55DR73A683KWJ1#	
			0.10μF	±10%	GRJ55DR73A104KWJ1#	
	630Vdc	X7R	0.15μF	±10%	GRJ55DR72J154KWJ1#	
				±10%	GRJ55DR72J224KWJ1#	
			250Vdc	X7R	0.33μF	±10%
	0.47μF	±10%				GRJ55DR72E474KWJ1#
				0.68μF	±10%	GRJ55DR72E684KWJ1#
					±10%	GRJ55DR72E105KWJ1#

品番 #には包装仕様コードが入ります。

GRMシリーズ
GJMシリーズ
GMAシリーズ
GMDシリーズ
GQMシリーズ
GRJシリーズ
GR3シリーズ
KRMシリーズ
KR3シリーズ
LLAシリーズ
LLLシリーズ
LLMシリーズ
LLRシリーズ
△注意/
使用上の注意

高実効容量・高リップル耐性品

GR3シリーズ



鳴き
対策

DCバイアス特性に優れた一般用高リップル耐性品です。

特徴

- ① DCバイアス印加時に、従来品(X7R特性)に比べて高い静電容量が得られます。
- ② 従来品(X7R特性)に比べて耐リップル性能を向上。

DC200V印加時で約2倍の静電容量が確保できています。

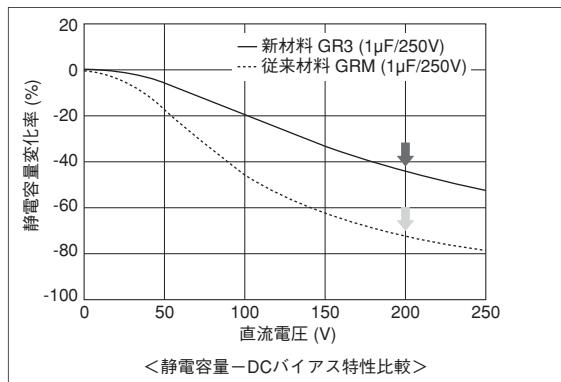

静電容量 1μF品の場合、周波数 f=300kHz時にて、発熱温度が20℃となる時の耐量は従来材料商品は 2.9Ar.m.s.ですが、新材料は4.7Ar.m.s.です。

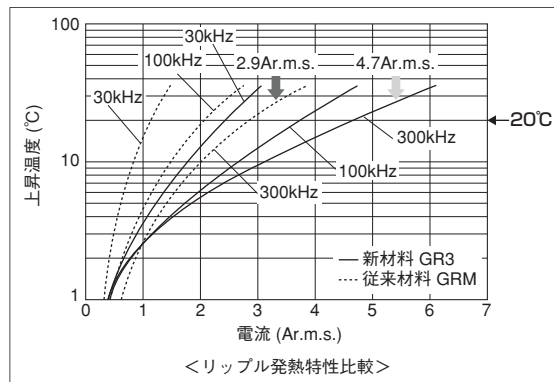

- ③ 鳴き低減効果があります。

鳴きの低減を可能とする誘電体材料を使用していますので、一般用のGRMシリーズに比べ、鳴き抑制に効果があります。

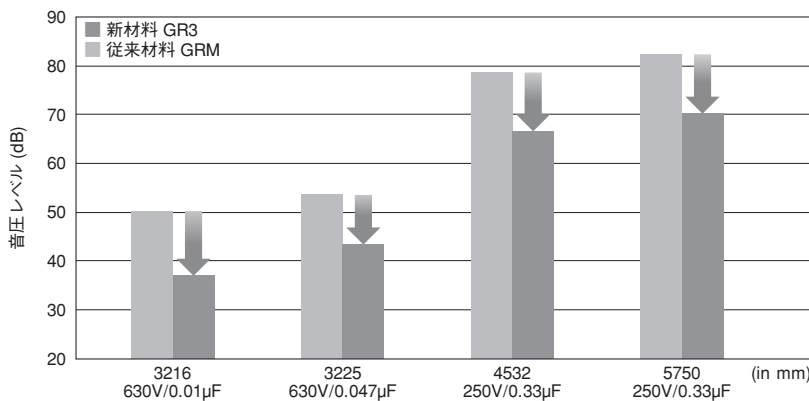

主な仕様

サイズ	2.0×1.25mm～5.7×5.0mm
定格電圧	DC250V～630V
静電容量	0.01μF～1.0μF
主な用途	電源のPFC(力率改善)回路、EMI除去、平滑回路用

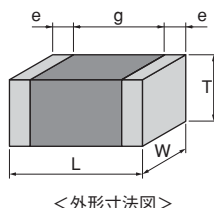

当カタログに掲載している製品は一部です。
 詳しくはWebサイトのコンデンサ検索ページをご参照ください。

GRMシリーズ
 GJMシリーズ
 GMAシリーズ
 GMDシリーズ
 GQMシリーズ
 GRJシリーズ
 GR3シリーズ
 KRMシリーズ
 KR3シリーズ
 LLAシリーズ
 LLLシリーズ
 LLMシリーズ
 LLRシリーズ
 △注意/使用上の注意

GR3シリーズ 高誘電率系 働き対策 品番表

■2.0×1.25mm

T寸法 最大値	定格 電圧	温度 特性	静電容量	許容差	品番
1.0mm	250Vdc	X7T	10000pF	±10%	GR321AD72E103KW01#
			15000pF	±10%	GR321AD72E153KW01#
1.45mm	250Vdc	X7T	22000pF	±10%	GR321BD72E223KW03#

■3.2×1.6mm

T寸法 最大値	定格 電圧	温度 特性	静電容量	許容差	品番
1.0mm	450Vdc	X7T	10000pF	±10%	GR331AD72W103KW01#
			15000pF	±10%	GR331AD72W153KW01#
	250Vdc	X7T	33000pF	±10%	GR331AD72E333KW01#
1.25mm	630Vdc	X7T	10000pF	±10%	GR331BD72J103KW01#
	450Vdc	X7T	22000pF	±10%	GR331BD72W223KW01#
			33000pF	±10%	GR331BD72W333KW01#
250Vdc	X7T	47000pF	±10%	GR331BD72E473KW01#	
1.8mm	630Vdc	X7T	15000pF	±10%	GR331CD72J153KW03#
	450Vdc	X7T	47000pF	±10%	GR331CD72W473KW03#
	250Vdc	X7T	68000pF	±10%	GR331CD72E683KW03#

■3.2×2.5mm

T寸法 最大値	定格 電圧	温度 特性	静電容量	許容差	品番
1.5mm	630Vdc	X7T	22000pF	±10%	GR332QD72J223KW01#
	250Vdc	X7T	0.10μF	±10%	GR332QD72E104KW01#
2.0mm	630Vdc	X7T	33000pF	±10%	GR332DD72J333KW01#
			47000pF	±10%	GR332DD72J473KW01#
	450Vdc	X7T	68000pF	±10%	GR332DD72W683KW01#
			0.10μF	±10%	GR332DD72W104KW01#
	250Vdc	X7T	0.15μF	±10%	GR332DD72E154KW01#

■4.5×3.2mm

T寸法 最大値	定格 電圧	温度 特性	静電容量	許容差	品番
1.5mm	250Vdc	X7T	0.22μF	±10%	GR343QD72E224KW01#
2.0mm	630Vdc	X7T	68000pF	±10%	GR343DD72J683KW01#
	450Vdc	X7T	0.15μF	±10%	GR343DD72W154KW01#
	250Vdc	X7T	0.33μF	±10%	GR343DD72E334KW01#

■5.7×5.0mm

T寸法 最大値	定格 電圧	温度 特性	静電容量	許容差	品番
2.0mm	630Vdc	X7T	0.10μF	±10%	GR355DD72J104KW01#
			0.15μF	±10%	GR355DD72J154KW01#
	450Vdc	X7T	0.22μF	±10%	GR355DD72W224KW01#
			0.33μF	±10%	GR355DD72W334KW01#
			0.47μF	±10%	GR355DD72W474KW01#
	250Vdc	X7T	0.47μF	±10%	GR355DD72E474KW01#
0.68μF			±10%	GR355DD72E684KW01#	
2.7mm	630Vdc	X7T	0.22μF	±10%	GR355XD72J224KW05#

T寸法 最大値	定格 電圧	温度 特性	静電容量	許容差	品番
2.7mm	630Vdc	X7T	0.27μF	±10%	GR355XD72J274KW05#
	450Vdc	X7T	0.56μF	±10%	GR355XD72W564KW05#
	250Vdc	X7T	1.0μF	±10%	GR355XD72E105KW05#

品番 #には包装仕様コードが入ります。

GRMシリーズ
GJMシリーズ
GMAシリーズ
GMDシリーズ
GQMシリーズ
GRJシリーズ
GR3シリーズ
KRMシリーズ
KR3シリーズ
LLAシリーズ
LLLシリーズ
LLMシリーズ
LLRシリーズ
△注意/
使用上の注意

金属端子付き 一般用

KRMシリーズ



鳴き
対策

たわみ
クラック

はんだ
クラック

外部電極に金属端子を接合することにより、大型MLCCの実装による設計課題を解決！

特徴

① チップの外部電極に金属端子を接合。

金属端子の弾性作用によりチップにかかるストレスを緩和します。

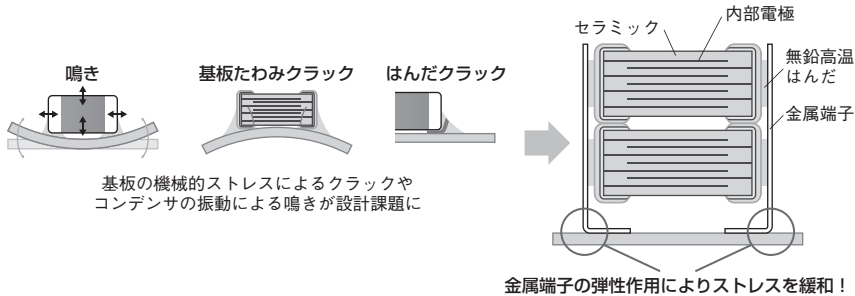

② 鳴きや基板たわみクラック、はんだクラックを大幅に低減。

基板たわみ6mmでも破壊しません。

熱ストレス2000サイクルでもはんだクラックが生じません。

● 金属端子による音鳴き低減効果

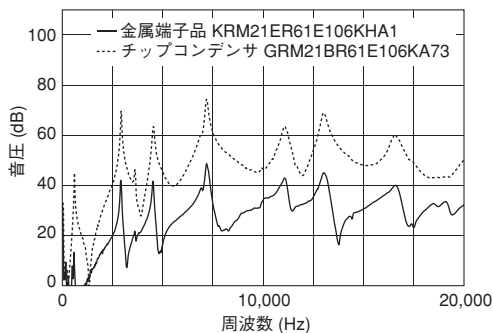

● 基板たわみによるストレスを軽減

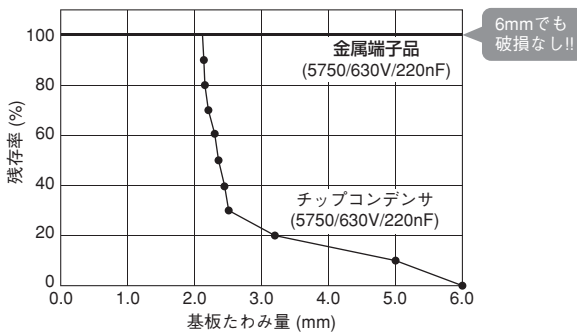

● 熱ストレスによるはんだクラックを抑制

チップサイズ	チップ単体 (5750サイズ)		金属端子品 (5750サイズ)	
1000サイクル				
2000サイクル				

試験条件：-55~+125°C、5分（液相）
 使用基板：ガラスエポキシ基板（FR-4）

チップ単体に比べ、はんだクラック耐性が優れています。

低鳴きコンデンサへの置換え評価を実演 KRMシリーズの効果をぜひ体感してみてください。

鳴き対策事例

GRMシリーズ
 GJMシリーズ
 GMAシリーズ
 GMDシリーズ
 GQMシリーズ
 GRJシリーズ
 GR3シリーズ
 KRMシリーズ
 KR3シリーズ
 LLAシリーズ
 LLLシリーズ
 LLMシリーズ
 LLRシリーズ
 △注意/使用上の注意

GRMシリーズ

GJMシリーズ

GMAシリーズ

GMDシリーズ

GQMシリーズ

GRJシリーズ

GR3シリーズ

KRMシリーズ

KR3シリーズ

LLAシリーズ

LLLシリーズ

LLMシリーズ

LLRシリーズ

△注意/
使用上の注意

③ チップの段積み対応。

2個のコンデンサを積み重ねることで、大容量化を実現しています。

主な仕様

サイズ	2.2×1.25mm～6.1×5.3mm
定格電圧	DC16V～1000V
静電容量	0.068μF～68μF
主な用途	DC-DCコンバータの平滑、ノイズ抑制用

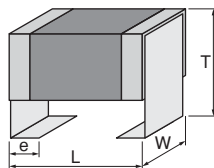

<外形寸法図>

当カタログに掲載している製品は一部です。
 詳しくはWebサイトのコンデンサ検索ページをご参照ください。

KRMシリーズ 高誘電率系 鳴き対策 たわみクラック はんだクラック 品番表

■3.5×1.7mm

T寸法 最大値	定格 電圧	温度 特性	静電容量	許容差	品番
2.0mm	25Vdc	X5R	10μF	±10%	KRM31FR61E106KH01#
2.9mm	100Vdc	X7R	1.0μF	±10%	KRM31KR72A105KH01#
	50Vdc	X7R	4.7μF	±10%	KRM31KR71H475KH01#
	35Vdc	X6S	10μF	±10%	KRM31KC8YA106KH01#
	25Vdc	X6S	10μF	±10%	KRM31KC81E106KH01#

T寸法 最大値	定格 電圧	温度 特性	静電容量	許容差	品番
5.0mm	25Vdc	X7R	33μF	±20%	KRM55TR71E336MH01#
6.7mm	100Vdc	X7R	15μF	±20%	KRM55WR72A156MH01#
	63Vdc	X7R	22μF	±20%	KRM55WR71J226MH01#
	50Vdc	X7R	33μF	±20%	KRM55WR71H336MH01#
	35Vdc	X7R	47μF	±20%	KRM55WR7YA476MH01#
	25Vdc	X7R	47μF	±20%	KRM55WR71E476MH01#
			68μF	±20%	KRM55WR71E686MH01#

■3.6×1.7mm

T寸法 最大値	定格 電圧	温度 特性	静電容量	許容差	品番
2.9mm	50Vdc	X7R	2.2μF	±10%	KRM31KR71H225KH01#

■3.7×1.85mm

T寸法 最大値	定格 電圧	温度 特性	静電容量	許容差	品番
2.9mm	100Vdc	X7R	2.2μF	±10%	KRM31KR72A225KH01#

■6.1×5.3mm

T寸法 最大値	定格 電圧	温度 特性	静電容量	許容差	品番
3.0mm	1000Vdc	X7R	68000pF	±10%	KRM55LR73A683KH01#
			0.10μF	±10%	KRM55LR73A104KH01#
	630Vdc	X7R	0.15μF	±10%	KRM55LR72J154KH01#
			0.22μF	±10%	KRM55LR72J224KH01#
	250Vdc	X7R	0.68μF	±10%	KRM55LR72E684KH01#
			1.0μF	±10%	KRM55LR72E105KH01#
	100Vdc	X7R	4.7μF	±10%	KRM55LR72A475KH01#
	63Vdc	X7R	4.7μF	±10%	KRM55LR71J475KH01#
	50Vdc	X7R	4.7μF	±10%	KRM55LR71H475KH01#
			10μF	±10%	KRM55LR71H106KH01#
	35Vdc	X7R	10μF	±10%	KRM55LR7YA106KH01#
			15μF	±10%	KRM55LR7YA156KH01#
	25Vdc	X7R	15μF	±10%	KRM55LR71E156KH01#
	3.9mm	100Vdc	X7R	6.8μF	±10%
63Vdc		X7R	10μF	±10%	KRM55QR71J106KH01#
50Vdc		X7R	17μF	±10%	KRM55QR71H176KH01#
			22μF	±10%	KRM55QR7YA226KH01#
25Vdc		X7R	22μF	±10%	KRM55QR71E226KH01#
	33μF		±10%	KRM55QR71E336KH01#	
5.0mm	1000Vdc	X7R	0.15μF	±20%	KRM55TR73A154MH01#
			0.22μF	±20%	KRM55TR73A224MH01#
	630Vdc	X7R	0.33μF	±20%	KRM55TR72J334MH01#
			0.47μF	±20%	KRM55TR72J474MH01#
	250Vdc	X7R	1.5μF	±20%	KRM55TR72E155MH01#
			2.2μF	±20%	KRM55TR72E225MH01#
	100Vdc	X7R	10μF	±20%	KRM55TR72A106MH01#
	50Vdc	X7R	22μF	±20%	KRM55TR71H226MH01#
	35Vdc	X7R	22μF	±20%	KRM55TR7YA226MH01#
			33μF	±20%	KRM55TR7YA336MH01#

品番 #には包装仕様コードが入ります。

GRMシリーズ
GJMシリーズ
GMAシリーズ
GMDシリーズ
GQMシリーズ
GRJシリーズ
GR3シリーズ
KRMシリーズ
KR3シリーズ
LLAシリーズ
LLLシリーズ
LLMシリーズ
LLRシリーズ
△注意/
使用上の注意

金属端子付き 高実効容量・高リップル耐性品

KR3シリーズ



鳴き対策 たわみクラック はんだクラック

外部電極に金属端子を接合することにより、大型MLCCの実装による設計課題を解決！

特徴

① チップの外部電極に金属端子を接合。

金属端子の弾性作用によりチップにかかるストレスを緩和します。

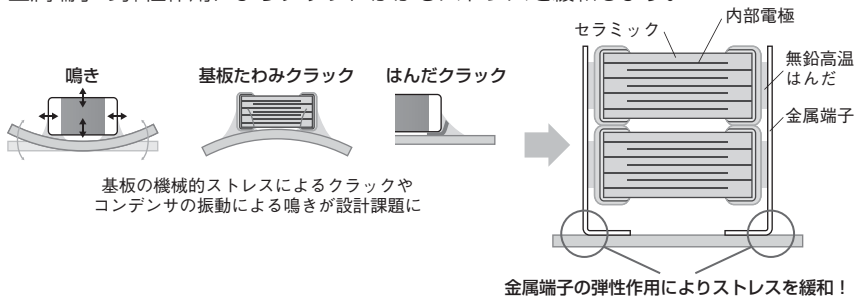

② 鳴きや基板たわみクラック、はんだクラックを大幅に低減。

基板たわみ6mmでも破壊しません。

熱ストレス2000サイクルでもはんだクラックが生じません。

● 鳴き低減効果の比較

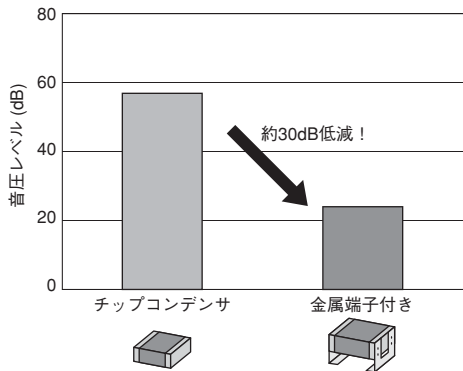

評価アイテム：5750サイズ/DC630V/220nF
 試験条件：DC50V、AC10Vp-p/3kHz
 試験基板：ガラスエポキシ基板 (T=1.6mm)
 試料数：3個
 マイク-基板間距離：3mm

(注) 当社評価基板での結果

● 基板たわみによるストレスを軽減

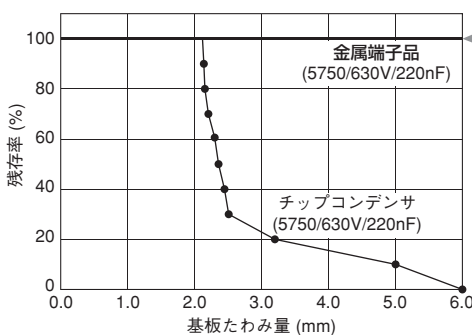

● 熱ストレスによるはんだクラックを抑制

チップサイズ	チップ単体 (5750サイズ)	金属端子品 (5750サイズ)
1000サイクル	 ↑はんだクラック	
2000サイクル	 ↑はんだクラック	

チップ単体に比べ、はんだクラック耐性が優れています。

試験条件：-55~+125°C、5分（液相）
 使用基板：ガラスエポキシ基板（FR-4）

GRMシリーズ
 GJMシリーズ
 GMAシリーズ
 GMDシリーズ
 GQMシリーズ
 GRUシリーズ
 GR3シリーズ
 KRMシリーズ
 KR3シリーズ
 LLAシリーズ
 LLRシリーズ
 LLMシリーズ
 LLRシリーズ
 △注意/使用上の注意

③ 低誘電率の材料を採用

従来品(X7R特性)に比べて実効容量、耐リップル性能を向上しました。

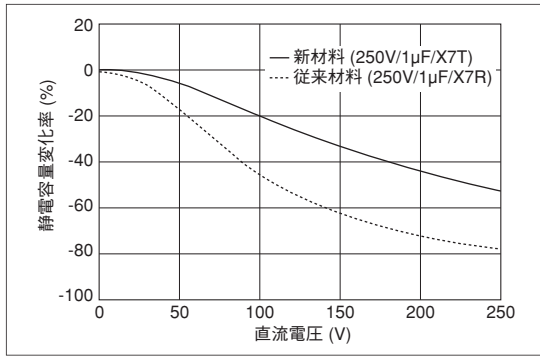

主な仕様

サイズ	6.1×5.3mm
定格電圧	DC250V~630V
静電容量	0.1μF~2.2μF
主な用途	一般電子機器のDC-DCコンバータ用

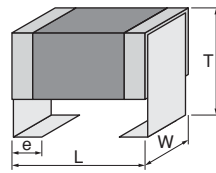

<外形寸法図>

当カタログに掲載している製品は一部です。
 詳しくはWebサイトのコンデンサ検索ページをご参照ください。

GRMシリーズ

GJMシリーズ

GMAシリーズ

GMDシリーズ

GQMシリーズ

GRJシリーズ

GR3シリーズ

KRMシリーズ

KR3シリーズ

LLAシリーズ

LLLシリーズ

LLMシリーズ

LLRシリーズ

△注意/
使用上の注意

KR3シリーズ 高誘電率系 鳴き対策 たわみクラック はんだクラック 品番表

■ 6.1 × 5.3mm

寸法 最大値	定格 電圧	温度 特性	静電容量	許容差	品番
3.0mm	630Vdc	X7T	0.10μF	±10%	KR355LD72J104KH01#
			0.15μF	±10%	KR355LD72J154KH01#
	450Vdc	X7T	0.22μF	±10%	KR355LD72W224KH01#
			0.33μF	±10%	KR355LD72W334KH01#
			0.47μF	±10%	KR355LD72W474KH01#
	250Vdc	X7T	0.47μF	±10%	KR355LD72E474KH01#
0.68μF			±10%	KR355LD72E684KH01#	
3.9mm	630Vdc	X7T	0.22μF	±10%	KR355QD72J224KH01#
			0.27μF	±10%	KR355QD72J274KH01#
	450Vdc	X7T	0.56μF	±10%	KR355QD72W564KH01#
			1.0μF	±10%	KR355QD72E105KH01#
	250Vdc	X7T	1.0μF	±10%	KR355QD72E105KH01#
			1.5μF	±20%	KR355TD72E155MH01#
5.0mm	450Vdc	X7T	0.68μF	±20%	KR355TD72W684MH01#
			1.0μF	±20%	KR355TD72W105MH01#
	250Vdc	X7T	1.5μF	±20%	KR355TD72E155MH01#
			2.2μF	±20%	KR355WD72E225MH01#
6.7mm	630Vdc	X7T	0.47μF	±20%	KR355WD72J474MH01#
			0.56μF	±20%	KR355WD72J564MH01#
	450Vdc	X7T	1.2μF	±20%	KR355WD72W125MH01#
			2.2μF	±20%	KR355WD72E225MH01#

GRMシリーズ

GJMシリーズ

GMAシリーズ

GMDシリーズ

GQMシリーズ

GRJシリーズ

GR3シリーズ

KRMシリーズ

KR3シリーズ

LLAシリーズ

LLLシリーズ

LLMシリーズ

LLRシリーズ

△注意/
使用上の注意

8端子型低ESL品

LLAシリーズ



低ESL

高速動作ICの電源デカップリングに最適な8端子型低ESLコンデンサ

特徴

① 超低ESL

構造の工夫により等価直列インダクタンス(ESL)が極めて低く、高周波特性が優れているため、高速動作ICの電源デカップリングに最適なコンデンサです。

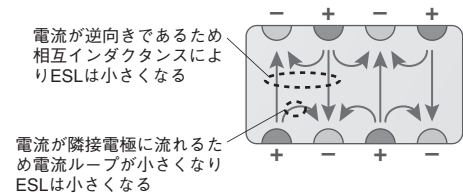
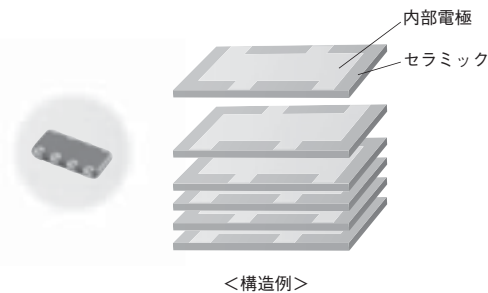

<相互インダクタンスによるインダクタンス打ち消し効果>

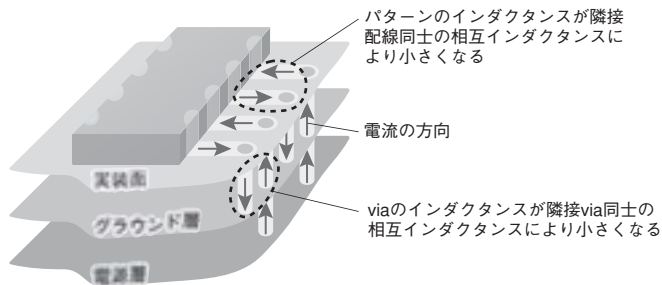

<多端子コンデンサを実装する時のインダクタンス抑制効果>

コンデンサだけでなく、基板分のインダクタンスも小さくなる。

② 最高使用温度125℃まで対応。

高温対応(X7*特性)であり、薄型品も多数取り揃えていますので、ICパッケージ上のデカップリングコンデンサとして最適です。

主な仕様

サイズ	1.6×0.8mm~3.2×1.6mm
定格電圧	DC4V~25V
静電容量	0.01μF~4.7μF
主な用途	Application processor/CPU/GPU

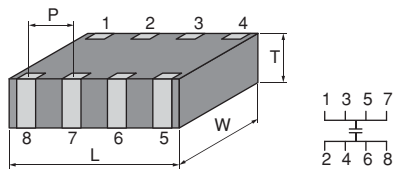

<外形寸法図>

当カタログに掲載している製品は一部です。
 詳しくはWebサイトのコンデンサ検索ページをご参照ください。

GRMSシリーズ

GJMシリーズ

GMAシリーズ

GMDシリーズ

GQMシリーズ

GRJシリーズ

GR3シリーズ

KRMシリーズ

KR3シリーズ

LLAシリーズ

LLLシリーズ

LLMシリーズ

LLRシリーズ

△注意/
使用上の注意

LLAシリーズ 高誘電率系 低ESL 品番表

■1.6×0.8mm

T寸法 最大値	定格 電圧	温度 特性	静電容量	許容差	品番
0.55mm	4Vdc	X7S	0.10μF	±20%	LLA185C70G104MA01#
			0.22μF	±20%	LLA185C70G224MA01#
			0.47μF	±20%	LLA185C70G474MA01#
			2.2μF	±20%	LLA185C70G225ME16#

■2.0×1.25mm

T寸法 最大値	定格 電圧	温度 特性	静電容量	許容差	品番	
0.55mm	25Vdc	X7R	10000pF	±20%	LLA215R71E103MA14#	
			22000pF	±20%	LLA215R71E223MA14#	
	16Vdc	X7R	47000pF	±20%	LLA215R71C473MA14#	
			0.10μF	±20%	LLA215R71C104MA14#	
	10Vdc	X7R	0.22μF	±20%	LLA215R71A224MA14#	
	6.3Vdc	X7R	0.47μF	±20%	LLA215R70J474MA14#	
	4Vdc	X7S	1.0μF	±20%	LLA215C70G105MA14#	
			4.7μF	±20%	LLA215C70G475ME19#	
	0.95mm	25Vdc	X7R	10000pF	±20%	LLA219R71E103MA01#
				22000pF	±20%	LLA219R71E223MA01#
				47000pF	±20%	LLA219R71E473MA01#
		16Vdc	X7R	0.10μF	±20%	LLA219R71C104MA01#
0.22μF				±20%	LLA219R71C224MA01#	
10Vdc		X7R	0.47μF	±20%	LLA219R71A474MA01#	
6.3Vdc		X7R	1.0μF	±20%	LLA219R70J105MA01#	
4Vdc		X7S	2.2μF	±20%	LLA219C70G225MA01#	

■3.2×1.6mm

T寸法 最大値	定格 電圧	温度 特性	静電容量	許容差	品番
0.55mm	16Vdc	X7R	0.22μF	±20%	LLA315R71C224MA14#
	10Vdc	X7R	0.47μF	±20%	LLA315R71A474MA14#
	6.3Vdc	X7R	1.0μF	±20%	LLA315R70J105MA14#
			2.2μF	±20%	LLA315R70J225MA14#
0.95mm	16Vdc	X7R	0.47μF	±20%	LLA319R71C474MA01#
	10Vdc	X7R	1.0μF	±20%	LLA319R71A105MA01#
1.25mm	16Vdc	X7R	1.0μF	±20%	LLA31MR71C105MA01#
	10Vdc	X7R	2.2μF	±20%	LLA31MR71A225MA01#

GRMシリーズ
GJMシリーズ
GMAシリーズ
GMDシリーズ
GQMシリーズ
GRJシリーズ
GR3シリーズ
KRMシリーズ
KR3シリーズ
LLAシリーズ
LLLシリーズ
LLMシリーズ
LLRシリーズ
△注意/
使用上の注意

LW逆転型低ESL品

LLLシリーズ **低ESL**

高速動作電子機器の電源デカップリングに最適な低ESLコンデンサです。

特徴

① 低ESL

等価直列インダクタンス(ESL)が低く高周波特性が優れているため、高速動作電子機器の電源デカップリングに適したコンデンサです。

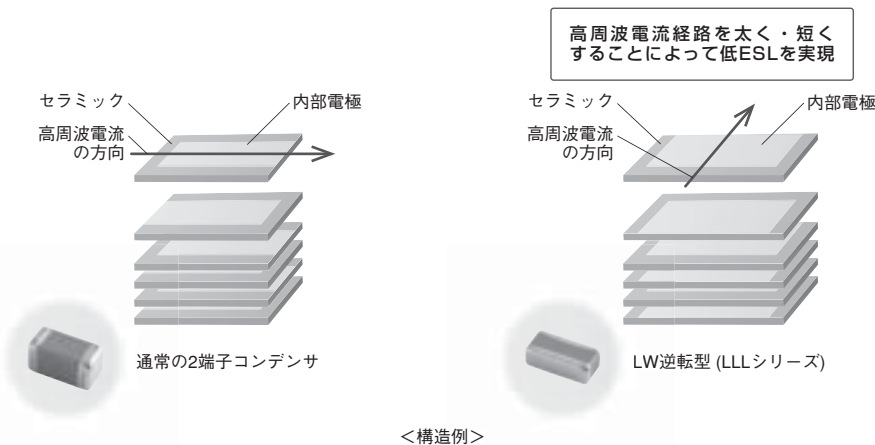

② 部品点数削減に貢献。

低ESLコンデンサを使用することで、一般用コンデンサ (GRMシリーズ) と同等の機能を維持しながら、部品点数削減が可能です。

LLLシリーズを利用した部品点数削減、高度なコストダウンをご提案します。シミュレーションも可能です。

▶ コストダウンのご提案

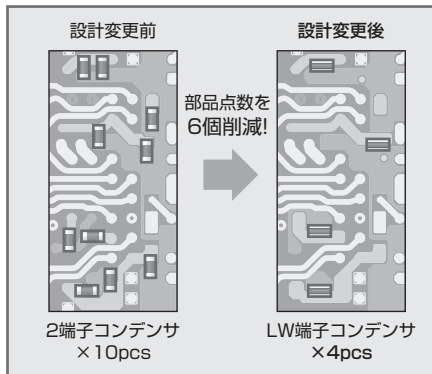

③ 最高使用温度125℃まで対応。

ICパッケージなどの高温になる箇所でもご使用いただけるX7*特性のラインアップも多く揃えています。

主な仕様

サイズ	0.5×1.0mm~1.6×3.2mm
定格電圧	DC2.5V~50V
静電容量	2,200pF~10μF
主な用途	Application processor/CPU/GPU

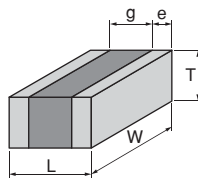

<外形寸法図>

当カタログに掲載している製品は一部です。詳しくはWebサイトのコンデンサ検索ページをご参照ください。

GRMシリーズ
 GJMシリーズ
 GMAシリーズ
 GMDシリーズ
 GQMシリーズ
 GRJシリーズ
 GR3シリーズ
 KRMシリーズ
 KR3シリーズ
 LLAシリーズ
 LLLシリーズ
 LLMシリーズ
 LLRシリーズ
 △注意/使用上の注意

LLLシリーズ 高誘電率系 低ESL 品番表

■0.5×1.0mm

寸法 最大値	定格 電圧	温度 特性	静電容量	許容差	品番
0.35mm	6.3Vdc	X6S	0.10μF	±20%	LLL153C80J104ME01#
			0.22μF	±20%	LLL153C80J224ME14#
	4Vdc	X7S	0.47μF	±20%	LLL153C70G474ME17#
		X6S	1.0μF	±20%	LLL153C80G105ME21#

■0.6×1.0mm

寸法 最大値	定格 電圧	温度 特性	静電容量	許容差	品番
0.45mm	4Vdc	X5R	4.3μF	±20%	LLL1U4R60G435ME22# <small>Densitrol</small>

■0.8×1.6mm

寸法 最大値	定格 電圧	温度 特性	静電容量	許容差	品番
0.5mm	25Vdc	X7R	10000pF	±20%	LLL185R71E103MA11#
			22000pF	±20%	LLL185R71C223MA11#
				±20%	LLL185R71C473MA11#
	10Vdc	X7R	0.10μF	±20%	LLL185R71A104MA11#
			X7S	0.22μF	±20%
0.55mm	4Vdc	X7S	2.2μF	±20%	LLL185C70G225ME01#
0.6mm	50Vdc	X7R	2200pF	±20%	LLL185R71H222MA01#
			4700pF	±20%	LLL185R71H472MA01#
				±20%	LLL185R71E103MA01#
	25Vdc	X7R	10000pF	±20%	LLL185R71E223MA01#
			22000pF	±20%	LLL185R71C473MA01#
			47000pF	±20%	LLL185R71A104MA01#
	10Vdc	X7R	0.10μF	±20%	LLL185R71A224MA01#
			0.22μF	±20%	LLL185R71A224MA01#
			0.47μF	±20%	LLL185C70G474MA01#

■1.25×2.0mm

寸法 最大値	定格 電圧	温度 特性	静電容量	許容差	品番		
0.5mm	50Vdc	X7R	10000pF	±20%	LLL215R71H103MA11#		
			25Vdc	X7R	22000pF	±20%	LLL215R71E223MA11#
					47000pF	±20%	LLL215R71C473MA11#
	10Vdc	X7R	0.10μF	±20%	LLL215R71C104MA11#		
			0.22μF	±20%	LLL215R71A224MA11#		
			0.47μF	±20%	LLL215R70J474MA11#		
			X7S	1.0μF	±20%	LLL215C70G105MA11#	
0.7mm	50Vdc	X7R	10000pF	±20%	LLL216R71H103MA01#		
			22000pF	±20%	LLL216R71H223MA01#		
				±20%	LLL216R71E473MA01#		
	25Vdc	X7R	47000pF	±20%	LLL216R71E104MA01#		
			0.10μF	±20%	LLL216R71A224MA01#		
0.95mm	16Vdc	X7R	0.22μF	±20%	LLL219R71C224MA01#		
			10Vdc	X7R	0.47μF	±20%	LLL219R71A474MA01#
					1.0μF	±20%	LLL219R71A105MA01#
	4Vdc	X7S	2.2μF	±20%	LLL219C70G225MA01#		

■1.6×3.2mm

寸法 最大値	定格 電圧	温度 特性	静電容量	許容差	品番		
0.5mm	50Vdc	X7R	10000pF	±20%	LLL315R71H103MA11#		
			22000pF	±20%	LLL315R71H223MA11#		
				±20%	LLL315R71E473MA11#		
	25Vdc	X7R	47000pF	±20%	LLL315R71E104MA11#		
			0.10μF	±20%	LLL315R71C224MA11#		
			0.22μF	±20%	LLL315R71A474MA11#		
0.8mm	50Vdc	X7R	10000pF	±20%	LLL317R71H103MA01#		
			22000pF	±20%	LLL317R71H223MA01#		
				±20%	LLL317R71H473MA01#		
	25Vdc	X7R	0.10μF	±20%	LLL317R71E104MA01#		
			16Vdc	X7R	0.22μF	±20%	LLL317R71C224MA01#
					0.47μF	±20%	LLL317R71C474MA01#
	10Vdc	X7R	1.0μF	±20%	LLL317R71A105MA01#		
			6.3Vdc	X7R	2.2μF	±20%	LLL317R70J225MA01#
1.25mm	50Vdc	X7R	0.10μF	±20%	LLL31MR71H104MA01#		
			25Vdc	X7R	0.22μF	±20%	LLL31MR71E224MA01#
					0.47μF	±20%	LLL31MR71E474MA01#
	16Vdc	X7R	1.0μF	±20%	LLL31MR71C105MA01#		
			10Vdc	X7R	2.2μF	±20%	LLL31MR71A225MA01#
					6.3Vdc	X7R	4.7μF
	X5R	10μF	±20%	LLL31MR60J106ME01#			

品番 #には包装仕様コードが入ります。

GRMシリーズ
GJMシリーズ
GMAシリーズ
GMDシリーズ
GDMシリーズ
GRJシリーズ
GR3シリーズ
KRMシリーズ
KR3シリーズ
LLAシリーズ
LLLシリーズ
LLMシリーズ
LLRシリーズ
△注意/
使用上の注意

10端子型低ESL品

LLMシリーズ



低
ESL

高速動作ICの電源デカップリングに最適な10端子型低ESLコンデンサ

特徴

① LW逆転型で最もESLが低いコンデンサ。

LLAシリーズ(8端子品)よりもさらに等価直列インダクタンス(ESL)が低く、高周波特性が優れているため、高速動作ICの電源デカップリングに最適なコンデンサです。

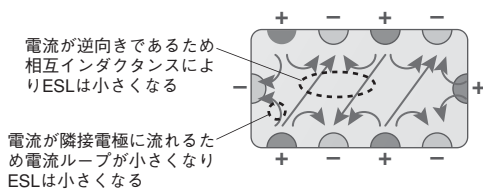
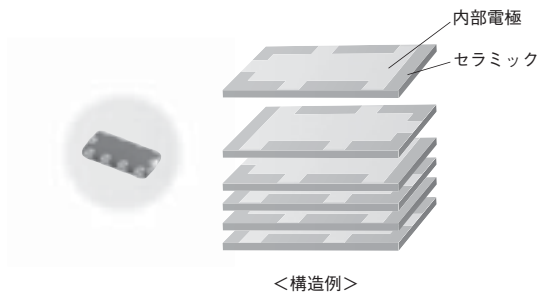

<相互インダクタンスによるインダクタンス打ち消し効果>

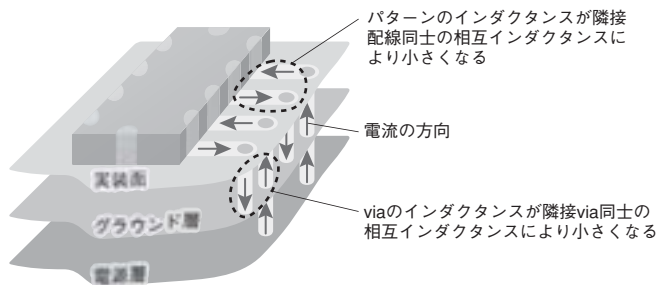

<多端子コンデンサを実装する時のインダクタンス抑制効果>

コンデンサだけでなく、基板分のインダクタンスも小さくなる。

② 最高使用温度125℃まで対応。

高温対応(X7*特性)であり、薄型品も多数取り揃えていますので、ICパッケージ上のデカップリングコンデンサとして最適です。

主な仕様

サイズ	2.0×1.25mm~3.2×1.6mm
定格電圧	DC4V~16V
静電容量	0.1μF~2.2μF
主な用途	Application processor/CPU/GPU

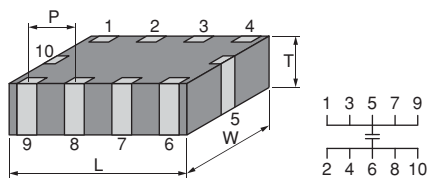

<外形寸法図>

当カタログに掲載している製品は一部です。
 詳しくはWebサイトのコンデンサ検索ページをご参照ください。

GRMSシリーズ

GUMシリーズ

GMAシリーズ

GMDシリーズ

GQMシリーズ

GRUシリーズ

GR3シリーズ

KRMシリーズ

KR3シリーズ

LLAシリーズ

LLLシリーズ

LLMシリーズ

LLRシリーズ

△注意/
使用上の注意

LLMシリーズ 高誘電率系 低ESL 品番表

■2.0×1.25mm

T寸法 最大値	定格 電圧	温度 特性	静電容量	許容差	品番
0.55mm	6.3Vdc	X7R	0.22μF	±20%	LLM215R70J224MA11#
			0.47μF	±20%	LLM215R70J474MA11#
	4Vdc	X7S	1.0μF	±20%	LLM215C70G105MA11#

■3.2×1.6mm

T寸法 最大値	定格 電圧	温度 特性	静電容量	許容差	品番
0.55mm	16Vdc	X7R	0.10μF	±20%	LLM315R71C104MA11#
			0.22μF	±20%	LLM315R71C224MA11#
	10Vdc	X7R	0.47μF	±20%	LLM315R71A474MA11#
	6.3Vdc	X7R	2.2μF	±20%	LLM315R70J225MA11#

GRMシリーズ

GJMシリーズ

GMAシリーズ

GMDシリーズ

GQMシリーズ

GRJシリーズ

GR3シリーズ

KRMシリーズ

KR3シリーズ

LLAシリーズ

LLLシリーズ

LLMシリーズ

LLRシリーズ

△注意/
使用上の注意

ESR制御型低ESL品

LLRシリーズ



低
ESL

反共振抑制機能を備えたESR制御型低ESLコンデンサ

特徴

① 反共振低減

等価直列抵抗 (ESR) が少し高めになるようコントロールされたコンデンサであり、コンデンサ並列使用などで発生する反共振を低減する効果があります。

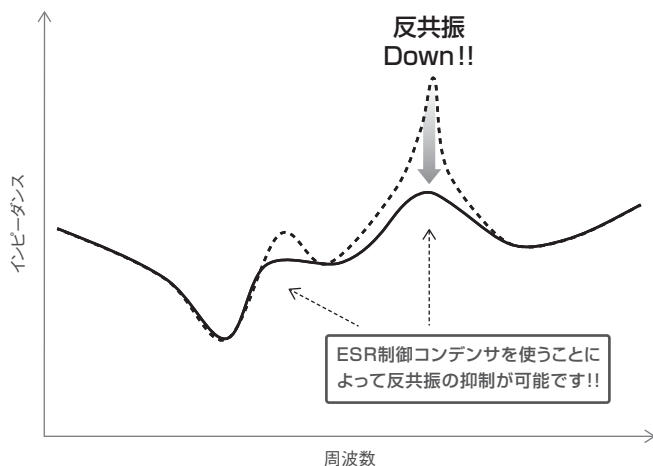

② ESR値は100～1,000mΩをラインアップ

反共振の状況により、4種類の中から最適なESR値をお選び頂くことができます。

③ 低ESL

ESR制御型コンデンサでありながら等価直列インダクタンス(ESL)が低く、優れた高周波特性を有しています。デカップリング素子としても最適です。

主な仕様

サイズ	0.8×1.6mm
定格電圧	DC4V
静電容量	1.0μF
主な用途	Network processor/ASIC/PMIC

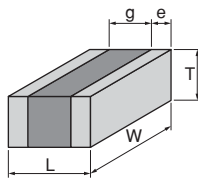

<外形寸法図>

当カタログに掲載している製品は一部です。
 詳しくはWebサイトのコンデンサ検索ページをご参照ください。

GRMSシリーズ

GJMシリーズ

GMAシリーズ

GMDシリーズ

GQMシリーズ

GRJシリーズ

GR3シリーズ

KRMシリーズ

KR3シリーズ

LLAシリーズ

LLLシリーズ

LLMシリーズ

LLRシリーズ

△注意/
使用上の注意

LLRシリーズ 高誘電率系 **低ESL** 品番表

■0.8×1.6mm

T寸法 最大値	定格 電圧	温度 特性	静電容量	許容差	品番	
0.55mm	4Vdc	X7S	1.0μF	±20%	LLR185C70G105ME01#	
				±20%	LLR185C70G105ME03#	
				±20%	LLR185C70G105ME05#	
				±20%	LLR185C70G105ME07#	

GRMシリーズ

GJMシリーズ

GMAシリーズ

GMDシリーズ

GQMシリーズ

GRJシリーズ

GR3シリーズ

KRMシリーズ

KR3シリーズ

LLAシリーズ

LLLシリーズ

LLMシリーズ

LLRシリーズ

△注意/
使用上の注意

△注意/使用上の注意

△注意

■保管・使用環境	142
■定格上の注意	142
1. 温度変化によるコンデンサの特性	142
2. 静電容量測定	142
3. 印加電圧	143
4. 印加電圧の種類および自己発熱温度	143
5. 直流電圧特性および交流電圧特性	146
6. 静電容量の経時変化	146
7. 振動または衝撃	147
■実装上の注意	147
1. 部品配置	147
2. 実装前の確認	148
3. 実装機の調整	148
4-1. はんだ取り付け：リフローはんだ付け	149
4-2. はんだ取り付け：フローはんだ付け	150
4-3. はんだ取り付け：はんだ付け部の修正	151
5. 洗浄	152
6. 基板検査	152
7. 基板分割	152
8. 組み付け作業	155
9. ダイボンド/ワイヤーボンド取り付け	156
■その他	156
1. 機器稼動中	156
2. その他	156

使用上の注意

■定格上の注意	157
1. 使用環境温度	157
2. 周囲環境での腐食性ガスおよび溶剤	157
3. 圧電現象	157
■実装上の注意	157
1. 基板設計	157
1. 基板パターン構成	157
2. ランド寸法	158
3. 基板設計	160
2. 接着剤塗布	160
3. 接着剤硬化	160
4. フラックス	160
5. フローはんだ付け	161
6. 洗浄	161
7. コーティング	161
■その他	162
1. 輸送	162
2. 実機での特性評価	162

GRMSシリーズ

GJMシリーズ

GMAシリーズ

GMDシリーズ

GQMシリーズ

GRJシリーズ

GR3シリーズ

KRMシリーズ

KR3シリーズ

LLAシリーズ

LLLシリーズ

LLMシリーズ

LLRシリーズ

△注意/
使用上の注意

△注意

■保管・使用環境

1. チップ積層セラミックコンデンサ（以下コンデンサと呼ぶ）を保管する場合、条件によって性能に影響を与える場合があります。

1-1. コンデンサは、室内温度5～40℃、相対湿度20～70%の環境下で保管してください。

- (1) 高温高湿環境下では端子電極の酸化によるはんだ付け性の低下や、テーピング、パッケージングなどの性能劣化が加速される場合がありますので、保管温度、湿度を守ってください。また、長期間の保管は電極の酸化が起こりますので、6ヶ月以内に使用してください。
- (2) 6ヶ月を超える場合は、はんだ付け性を確認の上、使用してください。
保管中は、最小包装単位は開封することなく、当初の包装の状態を保管してください。
短時間であっても、上記の温度および湿度条件から外れないようにしてください。

- 1-2. 大気中または雰囲気中の有害ガスによって、端子電極のはんだ付け性の劣化など信頼性を著しく低下させる可能性があります。
コンデンサは、腐食性ガス（硫化水素、二酸化イオウ、塩素、アンモニアなど）の雰囲気避けて保管してください。
- 1-3. 直射日光による端子電極の光化学変化や急激な湿度変化による結露から、はんだ付け性の劣化や性能劣化にいたる場合があります。
コンデンサは、直射日光や結露する場所に保管しないでください。

■定格上の注意

1. 温度変化によるコンデンサの特性

1. コンデンサは温度変化によって、電気的特性が変化します。

- 1-1. コンデンサには、温度依存性を持った誘電体磁器を使用しているため、使用温度範囲が広い場合は、静電容量が大幅に変化する場合があります。
静電容量を確保するためには、次のことを確認してください。
(1) 実動作使用温度範囲を狭めて、温度による静電容量変化率をおさえる。

- (2) 温度特性は、周囲温度が定格温度以下であっても、温度が変化すると、静電容量も変化する場合があります。高誘電率系コンデンサを時定数回路など静電容量許容範囲の狭い回路に使用される場合には、温度特性を十分に考慮いただき、実使用条件、および実機にて、諸特性を十分にご確認ください。

[静電容量 - 温度特性 R (R1) 特性の例]

試料：0.1μF 定格電圧DC50V

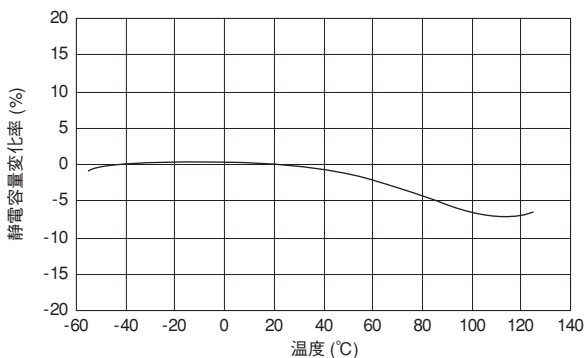

[静電容量 - 温度特性 B (B3) 特性の例]

試料：22μF 定格電圧DC4V

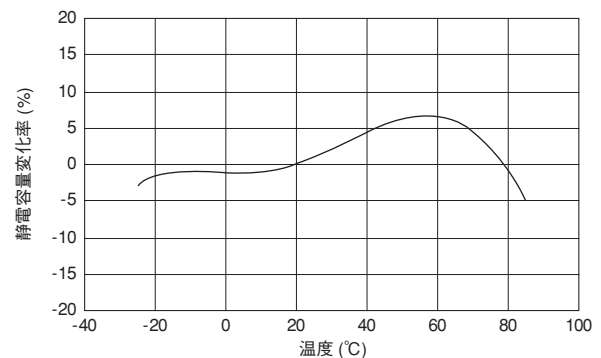

2. 静電容量測定

1. コンデンサは、その静電容量を得るために測定条件が規定されています。

- 1-1. 静電容量の大きなコンデンサの場合、測定器によって、コンデンサに設定した測定電圧が印加されず、測定結果の値が低く表示されることがあります。
コンデンサに所定の測定電圧が印加されているか確認をしてください。

- 1-2. 高誘電率系コンデンサは、交流電圧によって静電容量が変化します。コンデンサの静電容量測定は、規定の測定条件にて実施ください。

GRMシリーズ

GJMシリーズ

GMAシリーズ

GMDシリーズ

GQMシリーズ

GRUシリーズ

GR3シリーズ

KRMシリーズ

KR3シリーズ

LLAシリーズ

LLLシリーズ

LLMシリーズ

LLRシリーズ

△注意

☐ 前ページより続く

3. 印加電圧

1. コンデンサには、定格電圧を設定しています。

1-1. コンデンサの端子間に印加される電圧は、定格電圧以下としてください。

(1) 直流電圧に交流成分が重畳されている場合は、尖頭電圧の和（Zero-to-peak 電圧）を定格電圧以下にしてください。

交流電圧またはパルス電圧の場合は、尖頭電圧の和（Peak-to-peak 電圧）を定格電圧以下にしてください。

(2) 機器の通常の使用状態における印加電圧の他に、異常電圧（サージ電圧、静電気、スイッチ ON-OFF時のパルスなど）の印加の可能性についても確認し、定格電圧以下にしてください。

直流電圧で定格電圧が規定されているコンデンサに印加される電圧の例

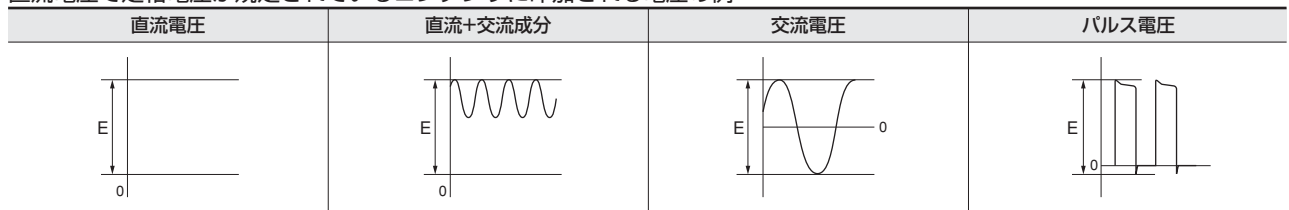

(E：最大可能印加電圧＝DC 定格電圧)

1-2. 過電圧が印加された場合

コンデンサに過電圧が印加されると、誘電体の絶縁破壊による電氣的ショートが発生する場合があります。なお、不具合にいたるまでの時間は、印加電圧および周囲温度によって異なります。

2. 電源入力回路（ACフィルタ）でご使用いただくコンデンサについては、機器ごとに定められている耐電圧、耐サージ電圧規定も考慮する必要があるため、安全規格認定コンデンサをご使用ください。

4. 印加電圧の種類および自己発熱温度

1. 交流電圧またはパルス電圧が連続印加され、コンデンサに大きな電流が流れるような使用条件かを確認してください。直流定格電圧品を交流電圧回路またはパルス電圧回路で使用する場合、交流電流またはパルス電流が流れるため、自己発熱を確認してください。コンデンサの表面温度は、自己発熱による温度上昇分も含み使用温度上限以内になるように確認してください。コンデンサを高周波電圧またはパルス電圧で使用すると、誘電体損失により発熱することがあります。
 <定格電圧DC100V以下に適用>

1-1. 雰囲気温度25℃の状態にて測定した時、製品本体の自己発熱が20℃以内、かつ実機でのコンデンサ表面温度が最高使用温度以内となるような負荷内でご使用ください。

[リップル（脈流）電流に対するチップ積層セラミックコンデンサの温度上昇（発熱）の例]

試料：R (R1) 特性10μF 定格電圧DC10V

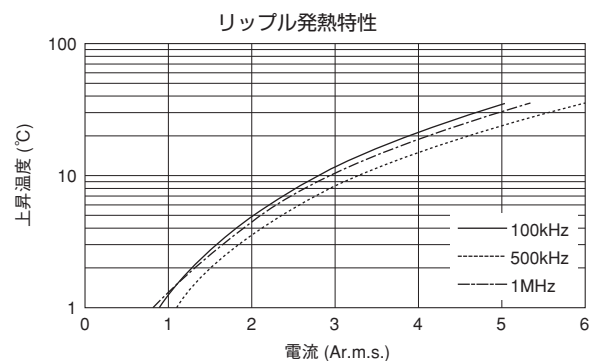

次ページに続く ☐

△注意

☞ 前ページより続く

<定格電圧DC200V以上の温度特性X7R (R7)、X7T (D7)に適用>

1-2. 雰囲気温度25℃の状態での測定した時、コンデンサ本体の自己発熱が20℃以内となるような負荷内でご使用ください。なお、測定に際しては熱容量の少ないφ0.1mmのK熱電対を使用し、他部品の輻射熱や対流による風の影響がない状態で測定してください。過度の発熱は、コンデンサの特性および信頼性の低下の原因となる場合があります。（冷却ファンを使用した状態での測定では、正確な測定ができない場合がありますので、絶対に行わないでください。）

<定格電圧DC200V以上の温度特性U2J (7U)、COG (5C)に適用>

1-3. 低損失シリーズは自己発熱が低いと、一般的なX7R (R7) 特性に比べて許容電力は非常に大きくなります。しかし、定格電圧で自己発熱20℃となる負荷を印加した場合、許容電力を超える可能性があります。1kHz以上の高周波電圧回路でご使用の場合、印加電圧の周波数が正弦波で500kHz以内（定格電圧DC3.15kV品は100kHz以内）とし、下図のディレーティング以内となるよう電圧負荷を制限してください。なお、非正弦波の場合には、基本周波数を超える高周波成分を含むことがありますので、弊社までご相談ください。過度の発熱は、コンデンサの特性・信頼性低下の原因となる場合があります。（冷却ファンを使用した状態での測定では、正確な測定ができない場合がありますので、絶対に行わないでください。）

コンデンサ温度：125℃以下
 （自己発熱分含む）

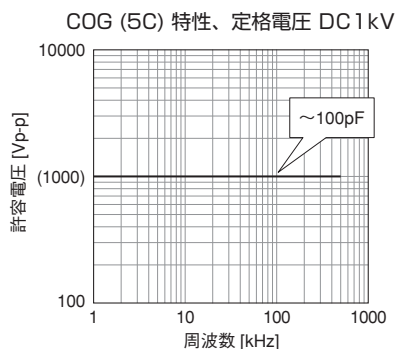
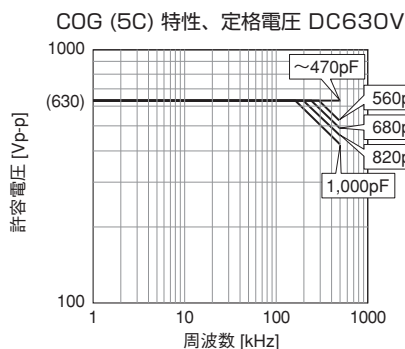
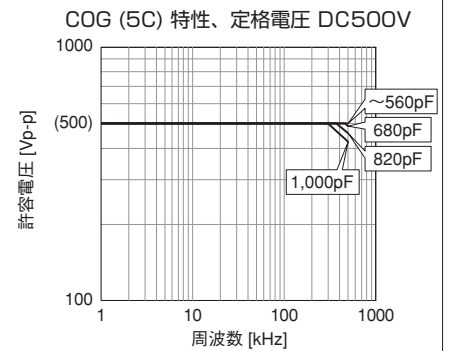
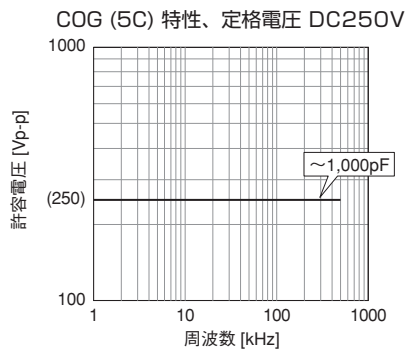
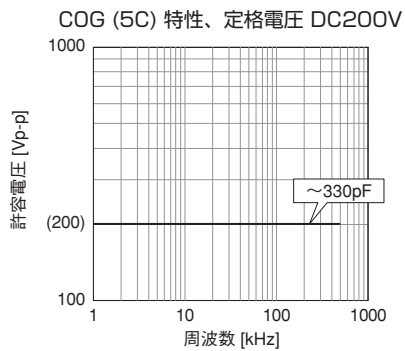

正弦波での周波数と許容電圧

次ページに続く ☞

前ページより続く

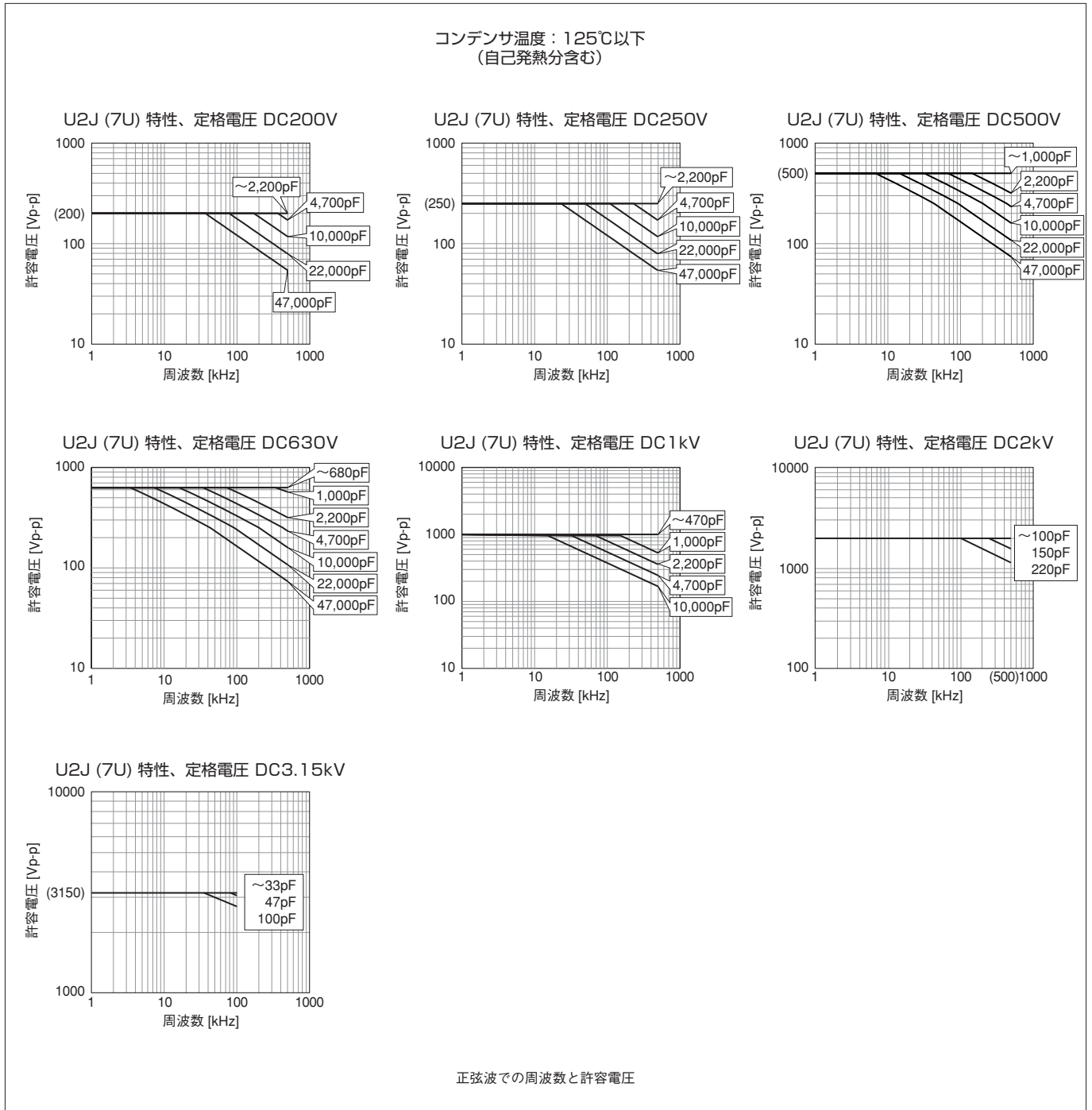

<設計支援ツール>

- ・ Simsurfing
 当社製品の特性のチャート表示、および特性データをダウンロードできるWEBアプリケーションです。
 周波数特性・温度特性・バイアス特性などが確認できます。
 (アドレス <http://www.murata.co.jp/simsurfing/>)
- ・ 中高圧セラミックコンデンサ選択ツール
 上記"Simurfing"には、車載向けも含め用途に応じた中高圧セラミックコンデンサの推奨可否の判定ができる選択ツール「Murata Medium Voltage Capacitors Selection Tool by Voltage Form」を搭載しています。
 当ツールをご利用いただくことで、コンデンサに入力する電圧波形の電力・電圧・基本周波数などの仕様から推奨する製品*をご確認いただけます。

*対応シリーズ GRM/DC200V以上の温度特性
 U2J (7U)、COG (5C)

△注意

☞ 前ページより続く

5. 直流電圧特性および交流電圧特性

1. 高誘電率系コンデンサは、直流電圧印加によって静電容量が変化します。
 使用前には、この直流電圧特性を考慮して、コンデンサを選定してください。

1-1. コンデンサには、電圧依存性を持った誘電体磁器を使用しているので、直流印加電圧が高い場合は、静電容量が大幅に変化する場合がありますので、静電容量を確保するためには、次のことを確認してください。

- (1) 印加電圧による静電容量変化が許容範囲にあるかまたは制限されない用途であるか確認してください。
- (2) 直流電圧特性は、印加電圧が定格電圧以下であっても、電圧が高くなるにつれ、静電容量の変化率も大きく（減少）なります。
 高誘電率系コンデンサを、時定数回路など許容範囲の狭い静電容量を必要とする回路に使用される場合には、電圧特性を十分に考慮いただき、実使用条件、および実機にて、諸特性を十分にご確認ください。

2. 高誘電率系コンデンサは、印加される交流電圧によって静電容量が変化します。
 使用する前には、この交流電圧特性を考慮して、コンデンサを選定してください。

6. 静電容量の経時変化

1. 高誘電率コンデンサには、静電容量の経時変化（エージング特性）があります。
 時定数回路などに使用する場合は、経時変化（エージング特性）を十分に考慮いただき、実使用条件、および実機にて、諸特性を十分にご確認ください。

[直流電圧特性の例]

試料：R (R1) 特性0.1μF 定格電圧DC50V

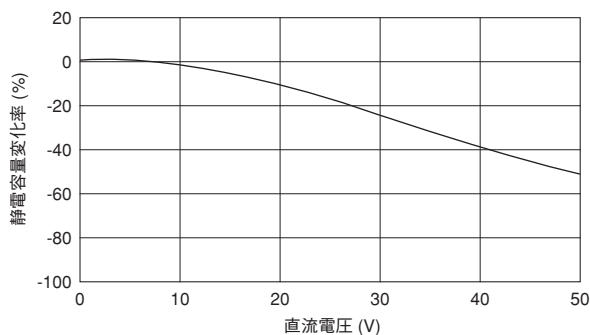

[交流電圧特性の例]

試料：X7R (R7) 特性10μF 定格電圧DC6.3V

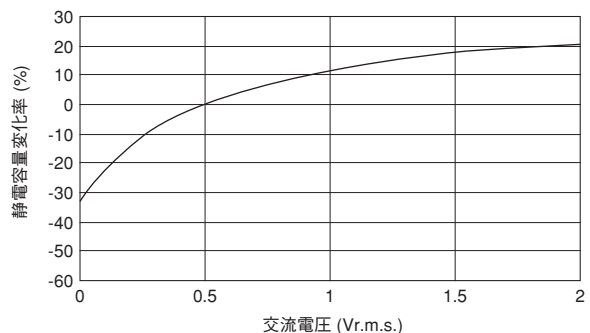

[経時変化（エージング特性）の例]

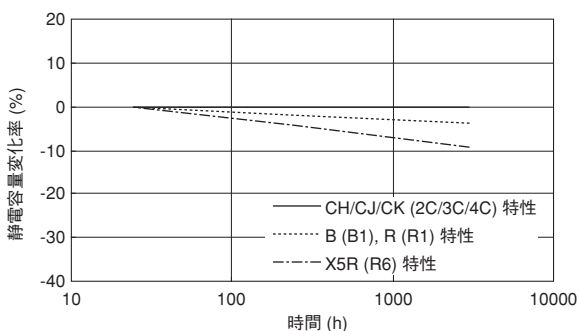

次ページに続く ☞

GRMシリーズ

GJMシリーズ

GMAシリーズ

GMDシリーズ

GQMシリーズ

GRUシリーズ

GR3シリーズ

KRMシリーズ

KR3シリーズ

LLAシリーズ

LLSシリーズ

LLMシリーズ

LLRシリーズ

△注意

前ページより続く

7. 振動または衝撃

- 振動または衝撃の種類もしくはそのレベルまたは共振の発生有無の確認が必要になります。
共振が発生しない取り付けまたはコンデンサの端子に衝撃が加わらないような取り付けが必要になります。
- コンデンサに過度の機械的衝撃または振動が加わった場合、コンデンサに破損またはクラックが発生する場合があります。落下したコンデンサは、すでに品質が損なわれている場合が多く、故障危険率が高くなる場合がありますので、落下したコンデンサは使用しないでください。
- 実装後の基板の積み重ね保管または取り扱い時に、基板の角がコンデンサにあたり、その衝撃で破損やクラックが発生し、耐電圧不良や絶縁抵抗の低下などにいたる場合もあります。

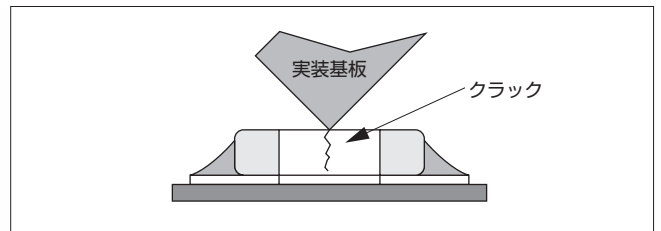
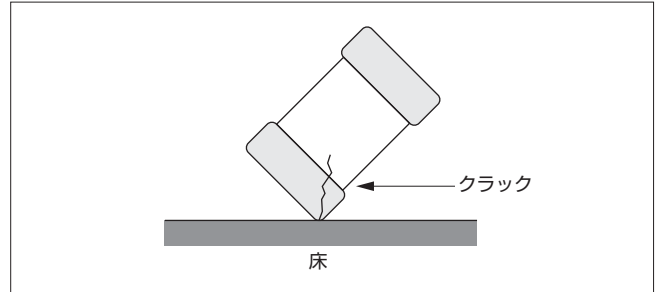

■実装上の注意

1. 部品配置

- コンデンサを基板にはんだ付けした後の工程または取り扱い中に基板が曲がると、コンデンサに割れが発生することがあります。基板のたわみに対して極力ストレスの加わらないようにコンデンサ配置を確認する必要があります。
 - 1-1. 基板のそり・たわみに対して極力ストレスが加わらないような部品配置にしてください。

[部品方向]

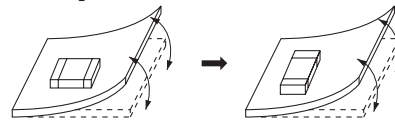

ストレスの作用する方向に対して横向きに部品を配置してください。

[基板ブレイク近辺でのコンデンサ配置]

基板分割でのストレスを軽減するために下記に示す対応策を実施することが有効です。下記に示す3つの対策をすべて実施することがベストですが、ストレスを軽減するために可能な限りの対策を実施ください。

対策内容	ストレスの大小
(1) 基板分割面に対する部品の配置方向を平行方向とする。	A > D
(2) 基板分割部にスリットを入れる。	A > B
(3) 基板分割面から部品の実装位置を離す。	A > C

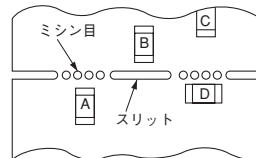

[ネジ穴近辺でのコンデンサ配置]

ネジ穴近辺にコンデンサを配置すると、ネジ締め時に発生する基板たわみの影響を受ける可能性があります。ネジ穴から極力離れた位置に配置ください。

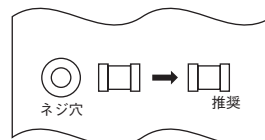

次ページに続く

△注意

☐ 前ページより続く

2. 実装前の確認

1. 機器に組み込んだコンデンサを取り外して、再使用することはできません。
2. コンデンサは、印加される電圧によって静電容量が変化するため、使用する直流、交流電圧によって静電容量の確認が必要になります。
3. コンデンサに過度な機械的衝撃が加わるか確認が必要になります。
4. コンデンサの静電容量、定格電圧、特性などを確認してから取り付ける必要があります。
5. 長期保管したコンデンサははんだ付け性を確認の上、使用する必要があります。
6. 長期放置した高誘電率系コンデンサは、経時変化により静電容量が低下している場合がありますので、静電容量を確認する前に熱処理をする必要があります。
7. Sn-Zn系はんだは、コンデンサの信頼性に悪影響を与えます。Sn-Zn系はんだをご使用の際は、事前に当社までご連絡ください。
8. 実装上の注意事項について、弊社知見をまとめたDVDも製作しております。ご入り用の際は弊社営業に連絡ください。

3. 実装機の調整

1. コンデンサを基板に実装する場合は、コンデンサ本体に次のような過度の衝撃荷重が加わらないことを確認する必要があります。
 - 1-1. 吸着ノズルの下死点が低すぎる場合は、実装時、コンデンサに過大な力が加わり、割れの原因となりますので、次のことを守ってください。
 - (1) 吸着ノズルの下死点は、基板のそりを矯正して、基板上面に設定し調整してください。
 - (2) 実装時のノズル圧力は、静荷重で1N~3Nとしてください。
2. 吸着ノズルとシリンダ内壁の間に、ごみ、ほこりなどが入ると、ノズルが滑らかに動かず実装時にコンデンサへ過大な力が加わり、チップ割れの原因となります。
また、位置決め爪が摩耗してくると、位置決め時にコンデンサへ加わる力が一定でなくなり、かけの原因となります。
吸着ノズル、位置決め爪の保守、点検および交換は定期的に行ってください。

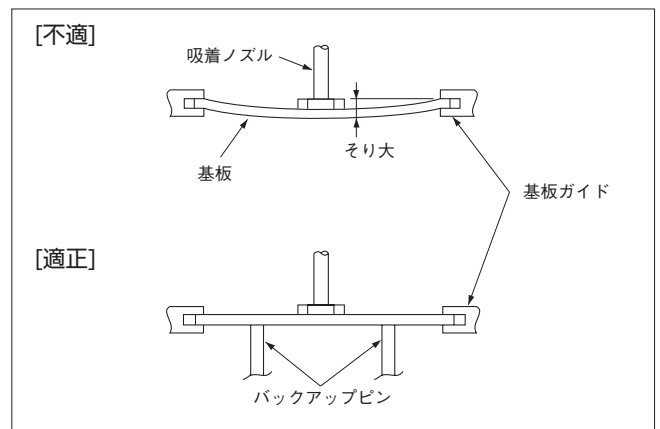

次ページに続く ☐

前ページより続く

4-1. はんだ取り付け：リフローはんだ付け

1. コンデンサへ急激に熱を加えると、内部で大きな温度差による歪みが生じて、クラックの発生や耐基板曲げ性低下の原因となります。

コンデンサのダメージを軽減するためにコンデンサおよび取り付け基板に必ず予熱を行ってください。

予熱の条件は、はんだ温度とコンデンサ表面温度の温度差 ΔT が表1の範囲内となるようにしてください。

ΔT が小さくなるほどコンデンサへの影響も小さくなります。また、チップ立ち、ずれ現象の防止にもなります。

- 外部電極すず(Sn)めっき品の場合、すず(Sn)の融点より低い温度ではんだ付けを行うと、外部電極へのはんだ濡れ性が低下し、はんだ付け不良の原因となります。必ず実装評価を実施して、はんだ付け性をご確認ください。
- はんだ付け直後に洗浄液に浸せきする際は、予熱温度差と同じように、冷却温度差が表1の ΔT を満足するように空冷過程を設けてください。

表1 許容温度差 ΔT

品番	温度差
GJM/GQM/GR3/GRJ/GRM/KRM/LLL/LLRシリーズの02/03/15/18/21/31サイズ LLLシリーズの1Uサイズ	$\Delta T \leq 190^\circ\text{C}$
GR3/GRJ/GRM/KR3/KRMシリーズの32/43/55サイズ LLA/LLMシリーズの18/21/31サイズ GQMシリーズの22サイズ	$\Delta T \leq 130^\circ\text{C}$

推奨条件

	Pb-Snはんだ		無鉛はんだ
	リフロー	ペーパーリフロー	
ピーク温度	230~250°C	230~240°C	240~260°C
雰囲気	大気	不活性溶剤の飽和蒸気	大気もしくはN ₂

Pb-Snはんだ：Sn-37Pb
 無鉛はんだ：Sn-3.0Ag-0.5Cu

4. 適正はんだ盛り量

- はんだ塗布厚が過剰になると、リフローはんだ付け時のはんだ盛り量が過多となり、基板より機械的・熱的ストレスを受けやすく、チップ割れの原因となります。
- はんだ塗布厚が過小になると、外部電極固着力不足を生じ、チップ脱落の原因となります。
- はんだが、滑らかに端面部に0.2mm以上*の高さまで上がっていることを確認してください。

基板反転

反転時に基板に異常な機械的衝撃が加わらないようにしてください。

[リフローはんだ付け標準条件]

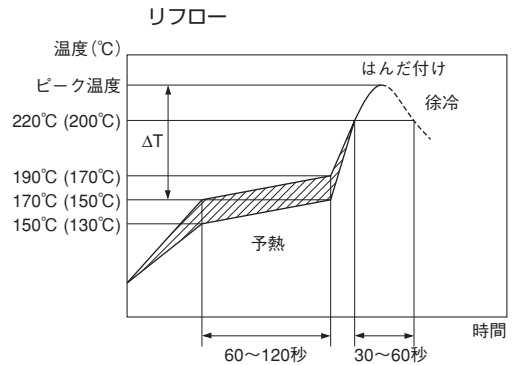

温度：無鉛はんだの場合、() 内はPb-Snはんだの場合
 はんだにより温度が異なります。

ペーパーリフロー

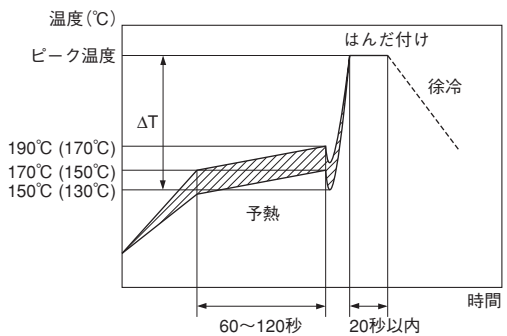

[リフローはんだ付け許容温度、時間]

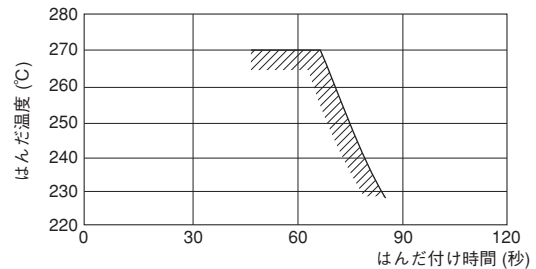

はんだ付けが繰り返される場合は、累積時間が上記時間を超えないようご注意ください。

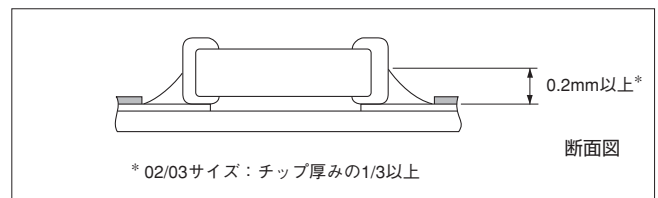

次ページに続く

GRM5シリーズ
 GJMシリーズ
 GMAシリーズ
 GMDシリーズ
 GQMシリーズ
 GRJシリーズ
 GR3シリーズ
 KRMシリーズ
 KR3シリーズ
 LLAシリーズ
 LLMシリーズ
 LLRシリーズ
 △注意

△注意

☞ 前ページより続く

4-2. はんだ取り付け：フローはんだ付け

1. 表2以外のコンデンサは、フローはんだ付けをしないでください。

表2 許容温度差 ΔT

品番	温度差
GR3/GRMシリーズの18/21/31サイズ GQMシリーズの18/21サイズ LLLシリーズの21/31サイズ 定格電圧DC250V以上の GRJシリーズの18/21/31サイズ	$\Delta T \leq 150^\circ\text{C}$

2. コンデンサへ急激に熱を加えると、内部で大きな温度差による歪みが生じて、クラックの発生や耐基板曲げ性低下の原因となります。
 コンデンサのダメージを軽減するためにコンデンサおよび取り付け基板に必ず予熱を行ってください。
 予熱の条件は、はんだ温度とコンデンサ表面温度の温度差 ΔT が表2の範囲内となるようにしてください。
 ΔT が小さくなるほどコンデンサへの影響も小さくなります。
3. はんだ付け時間が長すぎる場合や、はんだ付け温度が高すぎる場合は、外部電極のクワレが発生し、固着力低下または容量低下などの原因となります。
4. はんだ付け直後に洗浄液に浸せきする際は、予熱温度差と同じように、冷却温度差が表2の ΔT を満足するように空冷過程を設けてください。

推奨条件

	Pb-Snはんだ	無鉛はんだ
予熱ピーク温度	90~110°C	100~120°C
はんだ付けピーク温度	240~250°C	250~260°C
雰囲気	大気	大気

Pb-Snはんだ：Sn-37Pb
 無鉛はんだ：Sn-3.0Ag-0.5Cu

5. 適正はんだ盛り量

- 5-1. フローはんだ付け時のはんだ盛り量が過多になると、基板より機械的・熱的ストレスを受けやすく、チップ割れの原因になります。

[フローはんだ付け標準条件]

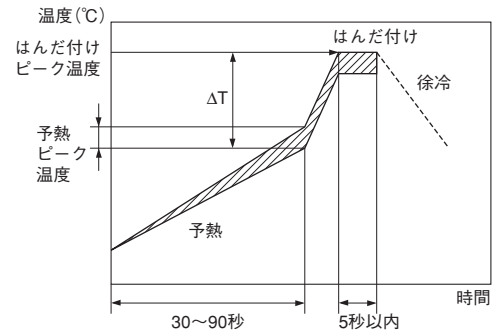

[フローはんだ付け許容温度、時間]

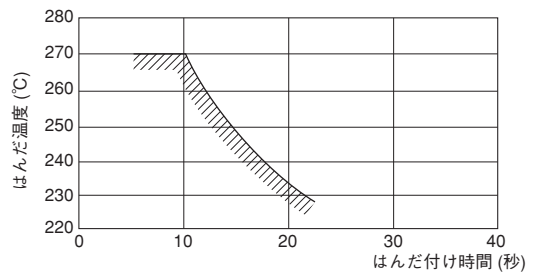

はんだ付けが繰り返される場合は、累積時間が上記時間を超えないようご注意ください。

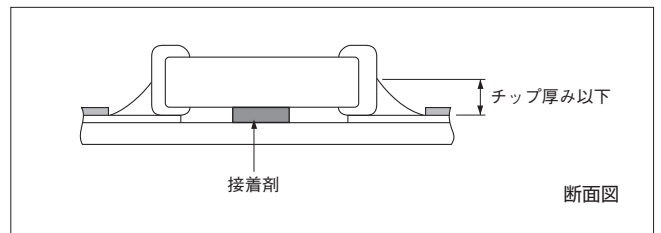

次ページに続く ☞

☐ 前ページより続く

4-3. はんだ取り付け：はんだ付け部の修正

コンデンサへ急激に熱を加えると、内部で大きな温度差による歪みが生じて、クラック発生の原因となります。また、基板予熱温度やはんだフィレット形状によって、機械的・熱的ストレスを受けやすくなり、クラックの原因となります。はんだ量やフィレット形状は、1. 基板設計や下記3. 適正はんだ盛り量を参照ください。

1. はんだコテを用いた修正

1-1. コンデンサのダメージを軽減するためにコンデンサおよび取り付け基板に必ず予熱を行ってください。予熱温度が表3の範囲となるようにしてください。予熱用加熱器具としては、ホットプレート、熱風式プリヒーター等があります。

1-2. はんだ取り付け後は徐冷を行ってください。

1-3. コテ修正はできるだけ短時間で作業してください。コテあて時間が長すぎる場合、端子電極のはんだクワレの発生につながる可能性があり、固着力低下などの原因となります。

2. スポットヒーターを用いた修正

はんだコテによる局所加熱と比較し、スポットヒーターによる熱風加熱は、部品および基板が全体的に加熱されるため、熱衝撃が緩和される傾向にあります。また、高密度実装基板の場合、部品へ直接はんだコテが触れる心配も回避することができます。

2-1. スポットヒータの熱風出口から部品までの距離が近すぎる場合、熱衝撃により、クラックが発生する場合があります。そのため、表4の条件を目安としてください。

2-2. はんだフィレット形状を適正にするために、図1に示す方向角度で熱風を当てる事を推奨します。

3. 適正はんだ盛り量

3-1. はんだ盛り量については、1608サイズ以下（GJM/GQM/GR3/GRJ/GRMシリーズの03/15/18サイズ）はチップ厚みの2/3、または0.5mmのいずれか小さい方の値以下、2012サイズ以上（GJM/GQM/GR3/GRJ/GRMシリーズの21/22/31/32/43/55サイズ）はチップ厚みの2/3以下にしてください。はんだコテ修正時のはんだ盛り量が過多になると基板より機械的・熱的ストレスを受けやすくクラックや耐基板曲げ性の低下、チップ割れの原因となります。

3-2. コテ先形状φ3mm以下をご使用ください。また、コンデンサ自体にコテ先が触れないように実施ください。

3-3. はんだの種類は線径φ0.5mm以下（ヤニ入り糸はんだ）をご使用ください。

表3

品番	コテ先温度	予熱温度	温度差	雰囲気
GJM/GQM/GR3/GRJ/GRMシリーズの03/15/18/21/31サイズ	350℃以下	150℃以上	$\Delta T \leq 190^\circ\text{C}$	大気
GRJ/GRMシリーズの32/43/55サイズ GQMシリーズの22サイズ	280℃以下	150℃以上	$\Delta T \leq 130^\circ\text{C}$	大気

*Pb-Snはんだ、無鉛はんだ共通です。

Pb-Snはんだ：Sn-37Pb

無鉛はんだ：Sn-3.0Ag-0.5Cu

表4

距離	5mm以上
熱風当て角度	45° *図1
熱風温度	400℃以下
当て時間	10秒間以内（3216サイズ以下）
	30秒間以内（3225サイズ以上）

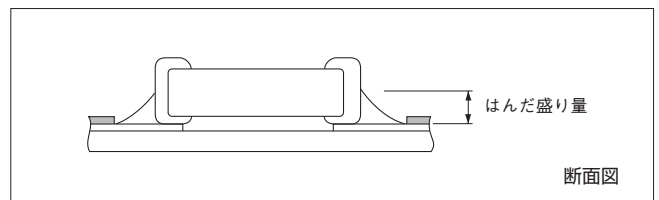
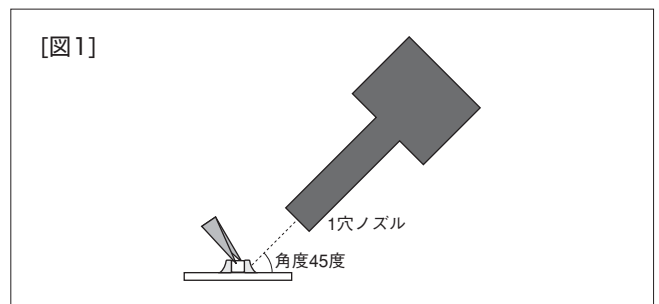

GRMシリーズ
GJMシリーズ
GMAシリーズ
GMDシリーズ
GQMシリーズ
GRJシリーズ
GR3シリーズ
KRMシリーズ
KR3シリーズ
LLAシリーズ
LLLシリーズ
LLMシリーズ
LLRシリーズ
△注意

△注意

☐ 前ページより続く

<KR3/KRMシリーズに適用>

4. コテ先形状は右図をご参照ください。

はんだの種類は線径φ0.5mm以下（ヤニ入り糸はんだ）をご使用ください。

4-1. はんだコテのあて方

コテ先は金属端子の下端にあててください。

- 1) セラミック素子の急加熱によるクラックを防ぐため、セラミック素地に直接触れないでください。
- 2) チップのズレ・外れを防ぐため、チップと金属端子との接合部およびその外側の金属部に直接触れないでください。

4-2. 適正はんだ量

コテ修正によるはんだ量はチップ下端の高さ以下にしてください。

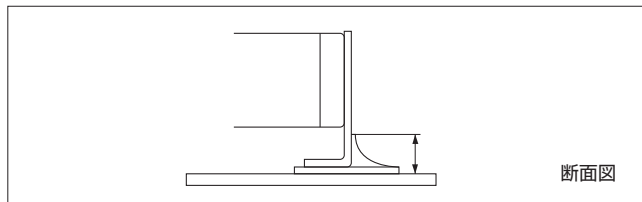
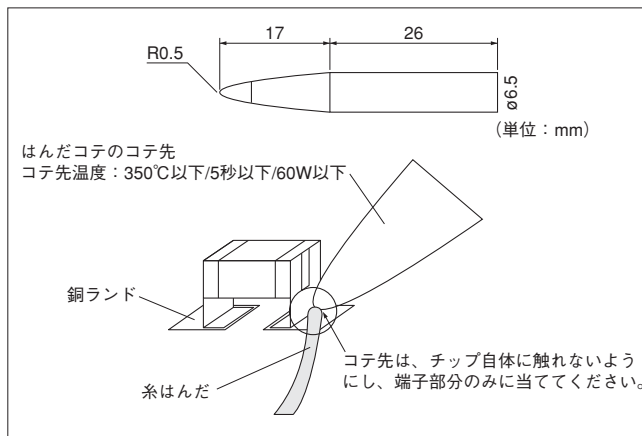

5. 洗浄

超音波洗浄の際、出力が大きすぎると基板が共振し、基板の振動によりチップクラックまたははんだ割れの原因となります。基板に直接振動が伝わらないようにしてください。

6. 基板検査

1. 実装後の基板でコンデンサを検査する際は、バックアップピンや専用ジグでの基板の固定の有無を確認する必要があります。

1-1. テストプローブなどの圧力で基板がたわまないようにしてください。

テストプローブの押し力により、基板がたわんでチップクラック、または、はんだ割れの原因となりますので、基板がたわまないよう基板裏面にバックアップピンを設けてください。バックアップピンは極力テストプローブに近づけてください。

1-2. 接触時の衝撃で基板が振動しないようにしてください。

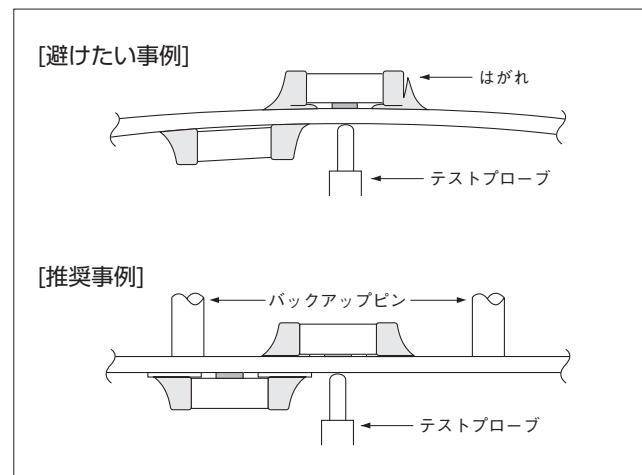

7. 基板分割

1. コンデンサを含む部品を実装後、基板分割作業の際には、基板にたわみやひねりストレスを与えないように注意してください。

1-1. 基板を分割する際に、基板に次の図に示すようなたわみやひねりなどのストレスを与えると、コンデンサにクラックが発生する場合があります。クラックが入ったコンデンサは絶縁抵抗が低下し、ショートに至る可能性があります。極力ストレスを加えないようにしてください。

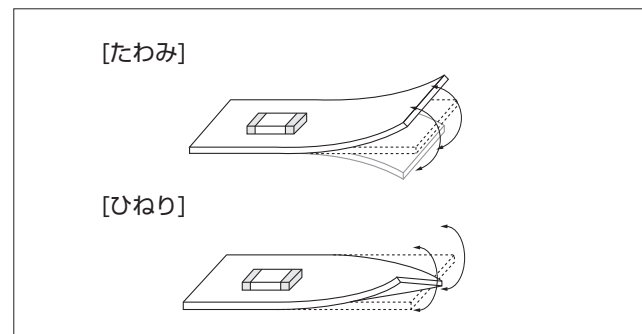

次ページに続く

前ページより続く

2. 基板分割時は、事前に確認してください。

2-1. 基板を分割する際には、できるだけ基板に機械的ストレスが加わらないようにするため、手割りを避け、次の図に示す基板分割ジグまたは基板分割装置（ディスクカットやルータカットなど）などを使用してください。
 下表および次項に注意事項についてまとめています。

基板分割方式	手割 ニッパ割	(1) 基板分割ジグ	基板分割装置	
			(2) ディスクカット	(3) ルータカット
基板へのストレスの大きさ	大	中	中	小
推奨	×	△*	△*	○
注意事項	手割、ニッパ割は大きなストレスが加わります。その他の方法をご使用ください。	<ul style="list-style-type: none"> 基板ハンドリング 基板折り曲げ方向 コンデンサの配置 	<ul style="list-style-type: none"> 基板ハンドリング スリットの配置 V溝の設計 ブレードの配置 ブレードのライフ管理 	基板ハンドリング

*基板分割ジグやディスクカットをお使いの場合、下記の注意点を守っていただかないと大きな基板たわみストレスが発生し、コンデンサにクラックが入ります。可能であればルータカットをご使用ください。

(1) 基板分割ジグの例

[片面実装の場合]

基板分割ジグの概要を次に示します。推奨事例として、ジグに近い部分を持ち、コンデンサが実装されている方向に折ることで部品実装位置のストレスを最小にすることができます。また、避けたい事例として、ジグから遠い部分を持ち、コンデンサが実装されていない方向に基板を折ることで部品実装位置に大きなストレスが加わり、コンデンサにクラック発生リスクが高くなります。

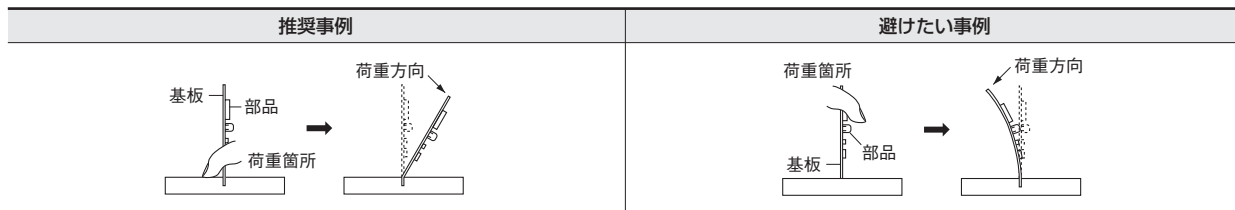
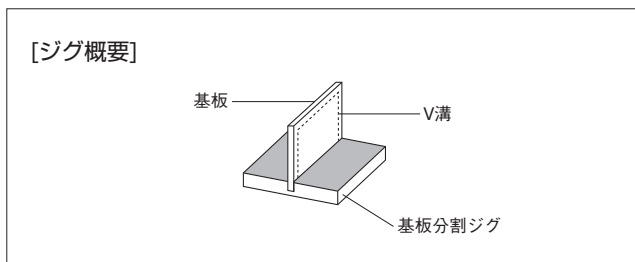

[両面実装の場合]

基板の両面に部品が実装されているため、上記の方法では、クラック発生リスクを回避できません。このため、下記の対策を実施して部品にストレスが加わらないようにしてください。

(対策)

- ① ルータカット機の導入を検討ください。
 ルータカット機の導入が難しい場合は、下記の対策を実施ください。(1.部品配置の項参照)
- ② 基板分割面に対して平行に部品を実装してください。
- ③ 基板分割面近くに部品を実装する場合は、部品近くの分割位置をスリットとしてください。
- ④ 基板分割位置より、部品の実装位置を離してください。

次ページに続く

GRM5シリーズ
 GJMシリーズ
 GMAシリーズ
 GMDシリーズ
 GQMシリーズ
 GRUJシリーズ
 GR3シリーズ
 KRMシリーズ
 KR3シリーズ
 LLAシリーズ
 LLLシリーズ
 LLMシリーズ
 LLRシリーズ
 △注意

△注意

☞ 前ページより続く

(2) ディスクカットの例

ディスクカット装置の概要を示します。また、原理図のように基板のV溝に支え刃とカット刃を沿うように合わせて、基板を分割します。

下記の場合、基板たわみストレスが加わりコンデンサにクラックが発生する原因となります。

- ① 上下の刃が、上下、左右、前後にずれるなど、調整が適切でない場合
- ② V溝の角度が低い、V溝の深さが浅い、V溝が上下でずれている場合

V溝の深さが深すぎるとハンドリング時に破断する恐れがありますのでV溝の深さは基材の強度を考慮した上で適切に設計ください。

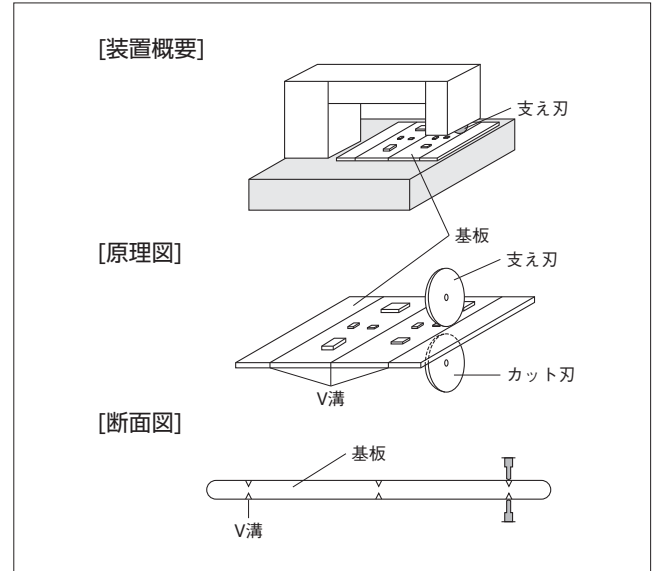

カット刃の推奨事例	避けたい事例		
	上下ずれ	左右ずれ	前後ずれ
<p>支え刃 カット刃</p>	<p>支え刃 カット刃</p>	<p>支え刃 カット刃</p>	<p>支え刃 カット刃</p>

V溝設計の推奨事例	避けたい事例			
	左右ずれ	角度が低い	深さが浅い	深さが深い

(3) ルータカットの例

ルータカット装置では、高速回転するルータによって切削加工を行います。切削加工では基板がたわまないため基板へのストレスを抑えて基板分割を行うことができます。ルータカット装置へ基板を組み付ける時および取り外し時に、基板がたわまないように取り扱いください。

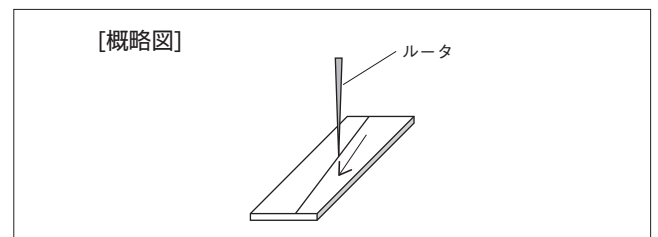

次ページに続く ☞

GRMシリーズ
GJMシリーズ
GMAシリーズ
GMDシリーズ
GQMシリーズ
GRUシリーズ
GR3シリーズ
KRMシリーズ
KR3シリーズ
LLAシリーズ
LLLシリーズ
LLMシリーズ
LLRシリーズ
△注意

☞ 前ページより続く

8. 組み付け作業

1. ハンドリング

コンデンサ実装後の基板を片手で取り扱おうと基板たわみを生じる可能性があります。両手で基板の端をしっかりと持ち取り扱ってください。

コンデンサ実装後の基板を落下させてしまった場合、コンデンサにクラックが入る可能性があります。落下した基板上のコンデンサは品質が損なわれている恐れがありますので使用しないでください。

2. その他部品の取付

2-1. その他部品の実装

片面にコンデンサ実装後、裏面にその部品を実装する際には下記の点に注意ください。

吸着ノズル下死点の設定が低すぎる場合、裏面（下面）の実装済みコンデンサに基板たわみストレスが加わり、コンデンサにクラックが入る可能性があります。

- ・ノズル下死点を基板反り矯正後に基板上面に設定してください。
- ・定期的の下死点の確認と調整を行ってください。

2-2. リード部品等の基板差し込み時

挿入部品（トランス、ICなど）の基板差し込み時に基板がたわむとクラックやはんだ割れの原因となります。下記の点に注意ください。

- ・リード挿入部の差し込み用穴を大きくし、挿入時の基板への応力を小さくする。
- ・バックアップピンや専用ジグで基板を固定して行う。
- ・基板が反らないように基板の下側より支持する。基板のバックアップピンを複数使用の場合、各々のバックアップピン高さに違いがないことを定期的を確認する。

2-3. ソケットの差し込み/抜き取り時

基板自体がコネクタになっている場合、ソケットの差し込み/抜き取りによる基板たわみが生じる可能性があります。ソケットの差し込み/抜き取り時に基板が反らないような作業を設定ください。

2-4. ビス/ネジ締め時

シールド板の基板取り付けや、基板のシャーシへの取り付けの際のビス締めなどによって基板たわみを生じる可能性があります。下記の点に注意して作業を設定ください。

- ・基板が反らないような作業に設定ください。
- ・トルクの設定できるドライバーを使用し、ネジの締めすぎを防止する。
- ・リフロー実装後などで基板が反ったりすることがあります。この基板をネジ締め時に強制的に平坦にすることでチップに応力を発生させることがあるのでご注意ください。

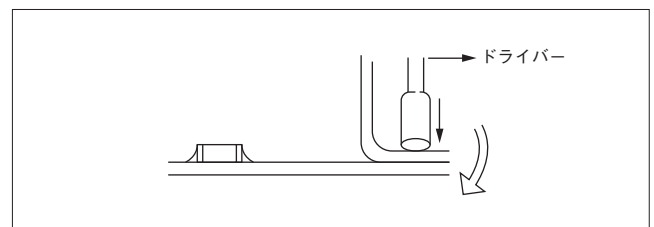
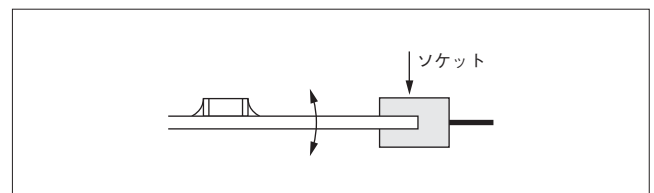
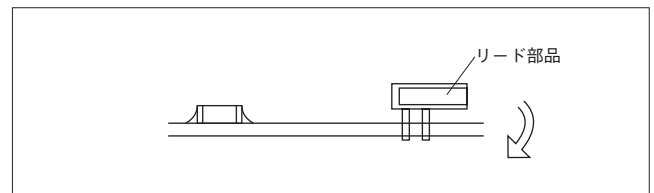
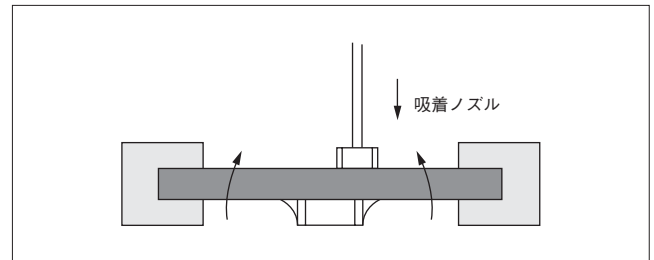

次ページに続く ☞

△注意

☐ 前ページより続く

<GMA/GMDシリーズに適用>

9. ダイボンド/ワイヤーボンド取り付け

1. コンデンサの取り付け

1-1. 使用材料

ろう材：80Au-20Sn 300~320℃ N₂雰囲気

1-2. 取り付け方法

- (1) 使用するろう材により融点異なるため、ろう材とあわせてホットプレート温度を調整してください。
- (2) コンデンサを取り付け部にろう材を置き、その上にコンデンサを置き、N₂ガス雰囲気中のホットプレート上に乗せコンデンサを軽く押さえ取り付けてください。

2. リード線の取り付け

2-1. リード線材料

Auワイヤー：25μm

2-2. 取り付け方法

- (1) 熱圧着もしくは超音波ボールボンダーを推奨します。
- (2) ステージ温度を150℃~200℃に調整ください。
- (3) 荷重は0.2N~0.5Nに調整してください
- (4) 金ワイヤーにてコンデンサとベース基板、もしくは隣接する他素子間との配線を行ってください。

■その他

1. 機器稼動中

- 1-1. 機器稼動中は、コンデンサに直接触れないでください。
- 1-2. コンデンサの端子間を導電体でショートさせないでください。
また、酸、アルカリ水溶液などの導電性溶液を、コンデンサにかけないでください。
- 1-3. コンデンサを取り付けたセットの設置環境および移動環境を確認し、次の環境下では、機器は使用しないでください。
 - (1) コンデンサに、水分または油がかかる環境。
 - (2) コンデンサに、直接日光が当たる環境。
 - (3) コンデンサに、オゾン、紫外線および放射線が照射される環境。
 - (4) 腐食性ガス（硫化水素、二酸化イオウ、塩素、アンモニアなど）に晒される環境。
 - (5) 振動または衝撃条件がコンデンサのカタログまたは納入仕様書に規定の値を超える環境。
 - (6) 結露するような環境の変化。
- 1-4. 結露する環境下でご使用になる場合は、防湿対策を施してご使用ください。

2. その他

2-1. 万一の場合

- (1) コンデンサが異常に発熱したり、発煙、発火および異臭が発生した場合、すぐに機器の主電源を切って使用を中止してください。
コンデンサが異常に発熱したり、発煙、発火および異臭が発生した場合、電源から電力を供給し続けると、さらに、拡大する場合があります。
- (2) 異常発生直後に、コンデンサの近くに顔や手を近づけないでください。
コンデンサが高温になった場合、やけどの原因になります。

2-2. 廃棄

コンデンサを廃棄する場合は、産業廃棄物処理業者に廃棄品を渡し、焼却埋立処理を行ってください。

2-3. 回路設計

- (1) フェールセーフ機能の付加
落下や基板たわみによりクラックが入ったコンデンサは絶縁抵抗低下を起こし、ショートに至る可能性があります。万一、コンデンサがショートした場合に感電、発煙、発火の恐れがある回路でお使いの場合には、二次災害防止のためにヒューズなどのフェールセーフ機能を必ず設置ください。
- (2) AC1次側回路で電磁障害防止用または結合/絶縁用として使用されるコンデンサは、安全規格認定品または電気用品安全法に規定の内容を満足するものを使用する必要があります。また、万一のショート時に備え、ラインごとヒューズを設置ください。
- (3) GJM/GMA/GMD/GQM/GR3/GRJ/GRM/KR3/KRM/LLA/LLL/LLM/LLRシリーズは、安全規格認定品ではありません。安全規格用途には使用しないでください。

2-4. 備考

記載内容を逸脱して当製品を使用しますと最悪の場合ショートにいたり発煙・破片の飛散等を起こすことがあります。
上述の諸注意事項は代表的なもので、特殊な実装条件については当社にお問い合わせください。
使用条件は、組み立て後のコンデンサの信頼性を左右しますので最適条件を設定してください。
当資料に記載されている特性グラフや関連データは、参考値であり保証値ではありません。

■定格上の注意

1. 使用環境温度

- 1. コンデンサには、使用温度範囲が設定されています。
 - 1-1. 使用温度は、機器内の温度分布および季節的な温度変動要因も考慮し、それに応じた使用温度範囲の製品を選定する必要があります。
 - 1-2. コンデンサは自己発熱する場合があります。コンデンサの表面温度は、自己発熱分を含み、最高使用温度以下にする必要があります。

2. 周囲環境での腐食性ガスおよび溶剤

- 1. コンデンサには、周囲環境に対して制限があります。
 - 1-1. 水または塩水がかかると回路的にショートします。また、端子が腐食したり水分が内部素子へ侵入することによって寿命が短くなったり、コンデンサの故障となる場合があります。

- 1-2. コンデンサの端子部が結露すると、上記と同様の現象が発生する場合があります。
- 1-3. 腐食性ガス（硫化水素、二酸化イオウ、塩素、アンモニアなど）や溶剤の揮発ガスに長期に晒されると、端子電極の酸化や腐食などによって特性劣化または絶縁劣化から破壊にいたる場合があります。

3. 圧電現象

- 1. 高誘電率系コンデンサを交流回路またはパルス回路で使用する場合、圧電現象（または電歪現象ともいう）により、ノイズや音が発生する場合があります。また、コンデンサに振動や衝撃を加えるとノイズが発生する場合があります。

■実装上の注意

1. 基板設計

1. 基板パターン構成

- 1-1. コンデンサは部品本体が直接基板に実装されるため、基板のストレスを受けやすくなります。はんだ付け時にははんだ盛り量が過多となった場合は、機械的、熱的ストレスをよく受けやすく割れの原因となります。基板設計時には、はんだ盛り量過多にならないようパターン形状・寸法について配慮し設計してください。

- 1-2. 基板の材質、構造によってチップへの応力は異なります。実装に用いる基板とチップとの熱膨張係数が大きく異なる場合、熱膨張・収縮によりチップ割れの原因となります。ガラスフッ素基板、単層のガラスエポキシ基板に搭載される場合も、同様な理由によりチップ割れの原因となる可能性があります。

パターン分割による改善事例

	禁止事例	改善事例
シャーシ近辺への配置	<p>シャーシ はんだ 電極パターン</p> <p>断面図</p>	<p>ソルダーレジスト</p> <p>断面図</p>
リード付き部品との混載	<p>リード付き部品のリード線</p> <p>断面図</p>	<p>ソルダーレジスト</p> <p>断面図</p>
リード付き部品の後付け	<p>はんだコテ 後付け部品のリード線</p> <p>断面図</p>	<p>ソルダーレジスト</p> <p>断面図</p>
横置き配置		<p>ソルダーレジスト</p>

次ページに続く

GRMSシリーズ
GJMシリーズ
GMAシリーズ
GMDシリーズ
GQMシリーズ
GRJシリーズ
GR3シリーズ
KRMシリーズ
KR3シリーズ
LLAシリーズ
LLLシリーズ
LLMシリーズ
LLRシリーズ
使用上の注意

使用上の注意

☐ 前ページより続く

2. ランド寸法

2-1. ランド面積を必要以上に大きくするとはんだ量が多くなりすぎて、基板の曲げなどの影響によりコンデンサが割れやすくなります。

以下の表のランド寸法を参考に、実機にて適正値を確認してください。

表1. フローはんだ付け

表2. リフローはんだ付け

表3. LLAシリーズのリフローはんだ付け

表4. LLMシリーズのリフローはんだ付け



表1 フローはんだ付け用ランド寸法例

品番	寸法	チップ (L×W)	a	b	c
GQM/GR3/GRJ/GRMシリーズの18サイズ		1.6×0.8	0.6~1.0	0.8~0.9	0.6~0.8
GQM/GR3/GRJ/GRMシリーズの21サイズ		2.0×1.25	1.0~1.2	0.9~1.0	0.8~1.1
GR3/GRJ/GRMシリーズの31サイズ		3.2×1.6	2.2~2.6	1.0~1.1	1.0~1.4
LLLシリーズの21サイズ		1.25×2.0	0.4~0.7	0.5~0.7	1.4~1.8
LLLシリーズの31サイズ		1.6×3.2	0.6~1.0	0.8~0.9	2.6~2.8

フローはんだ付けは、チップサイズが1.6×0.8mmから3.2×1.6mm以下の製品のみ可能です。

(単位：mm)

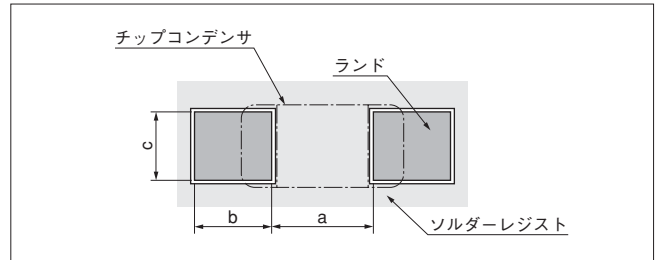
表2 リフローはんだ付け用ランド寸法例

品番	寸法	チップ (L×W)	a	b	c
GJM/GRMシリーズの02サイズ		0.4×0.2	0.16~0.2	0.12~0.18	0.2~0.23
GJM/GRMシリーズの03サイズ		0.6×0.3	0.2~0.3	0.2~0.35	0.2~0.4
GJM/GRMシリーズの15サイズ		1.0×0.5 (±0.10以内)	0.3~0.5	0.35~0.45	0.4~0.6
		1.0×0.5 (±0.15/±0.20)	0.4~0.6	0.4~0.5	0.5~0.7
GQM/GR3/GRJ/GRMシリーズの18サイズ		1.6×0.8 (±0.10以内)	0.6~0.8	0.6~0.7	0.6~0.8
		1.6×0.8 (±0.15/±0.20)	0.7~0.9	0.7~0.8	0.8~1.0
GQMシリーズの21サイズ		2.0×1.25	1.0~1.2	0.6~0.7	0.8~1.1
GR3/GRJ/GRMシリーズの21サイズ		2.0×1.25 (±0.10以内)	1.2	0.6	1.25
		2.0×1.25 (±0.15)	1.2	0.6~0.8	1.2~1.4
		2.0×1.25 (±0.20)	1.0~1.4	0.6~0.8	1.2~1.4
GR3/GRJ/GRMシリーズの31サイズ		3.2×1.6 (±0.20以内)	1.8~2.0	0.9~1.2	1.5~1.7
		3.2×1.6 (±0.30)	1.9~2.1	1.0~1.3	1.7~1.9
GR3/GRJ/GRMシリーズの32サイズ		3.2×2.5	2.0~2.4	1.0~1.2	1.8~2.3
GR3/GRJ/GRMシリーズの43サイズ		4.5×3.2	3.0~3.5	1.2~1.4	2.3~3.0
GR3/GRJ/GRMシリーズの55サイズ		5.7×5.0	4.0~4.6	1.4~1.6	3.5~4.8
LLLシリーズの15サイズ		0.5×1.0	0.15~0.2	0.2~0.25	0.7~1.0
LLLシリーズの1Uサイズ		0.6×1.0	0.20~0.25	0.25~0.35	0.7~1.0
LLL/LLRシリーズの18サイズ		0.8×1.6	0.2~0.3	0.3~0.4	1.4~1.6
LLLシリーズの21サイズ		1.25×2.0	0.4~0.5	0.4~0.5	1.4~1.8
LLLシリーズの31サイズ		1.6×3.2	0.6~0.8	0.6~0.7	2.6~2.8
GQMシリーズの22サイズ		2.8×2.8	2.2~2.5	0.8~1.0	1.9~2.3

(単位：mm)

<KR3/KRMに適用>

品番	寸法	チップ (L×W)	a	b	c
KRMシリーズの21サイズ		2.0×1.25	1.0~1.2	0.6~0.7	0.8~1.1
KRMシリーズの31サイズ		3.2×1.6	2.2~2.4	0.8~0.9	1.0~1.4
KR3/KRMシリーズの55サイズ		5.7×5.0	2.6	2.7	5.6

(単位：mm)

次ページに続く ☐

使用上の注意

前ページより続く



表3 LLAシリーズのリフローはんだ付け用ランド寸法例

品番	寸法	チップ (L×W)	a	b	c	p
LLAシリーズの18サイズ		1.6×0.8	0.3~0.4	0.25~0.35	0.15~0.25	0.4
LLAシリーズの21サイズ		2.0×1.25	0.5~0.7	0.35~0.6	0.2~0.3	0.5
LLAシリーズの31サイズ		3.2×1.6	0.7~0.9	0.4~0.7	0.3~0.4	0.8

(単位：mm)

表4 LLMシリーズのリフローはんだ付け用ランド寸法例

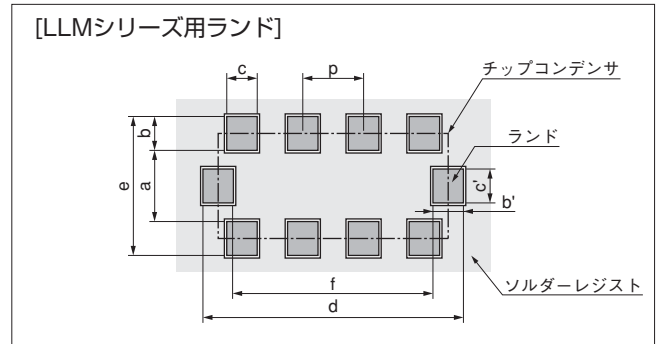
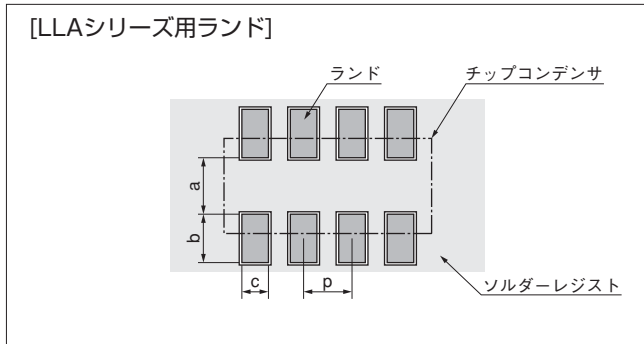
品番	寸法	チップ (L×W)	a	b, b'	c, c'	d	e	f	p
LLMシリーズの21サイズ		2.0×1.25	0.6~0.8	(0.3~0.5)	0.3	2.0~2.6	1.3~1.8	1.4~1.6	0.5
LLMシリーズの31サイズ		3.2×1.6	1.0	(0.3~0.5)	0.4	3.2~3.6	1.6~2.0	2.6	0.8

$b=(c-e)/2, b'=(d-f)/2$

(単位：mm)

<定格電圧DC250V以上に適用>

2-2. 推奨スリット寸法

ランド間にスリットを設けると、洗浄性の向上が期待できます。またチップ裏面への樹脂コーティングも容易になります。

なお、基板スリットが長い場合、機械的ストレスの影響を受けやすくなりクラック発生の原因となることがありますので、基板スリットの長さは表の値を目安に必要最小限としてください。

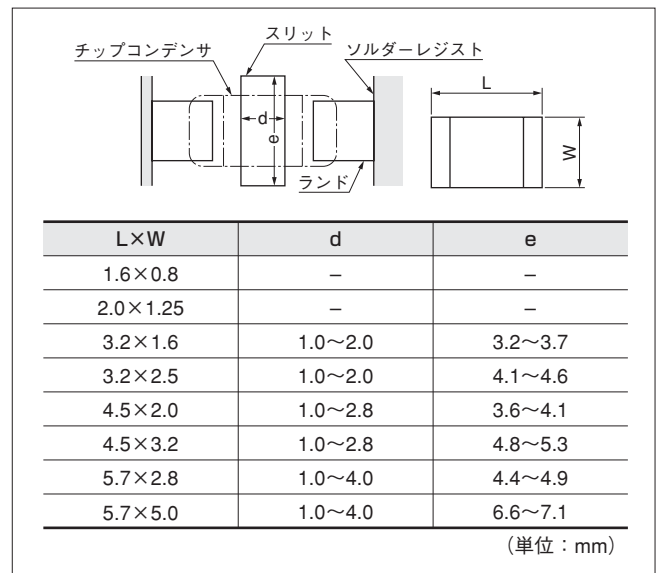

次ページに続く

使用上の注意

☑ 前ページより続く

3. 基板設計

作業をする上で基板の大きさや材質により、発生するひずみ量が大きくなりますので基板設計時に注意してください。

[基板厚み、長さ、幅などのひずみ量との関係]

$$\varepsilon = \frac{3PL}{2Ewh^2}$$

荷重とひずみの関係

ε：基板中央のひずみ量 (μst)
 L：支点間距離 (mm)
 w：基板幅 (mm)
 h：基板厚み (mm)
 E：基板の弾性率 (N/m²=Pa)
 Y：たわみ量 (mm)
 P：荷重 (N)

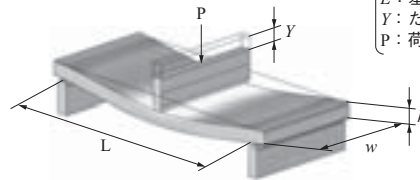

荷重が一定の場合、下記の関係が成り立ちます。
 ・支点間距離 (L) が大きいほど、ひずみ量は大きくなります。
 → 支点間距離は、小さくしてください。
 ・弾性率 (E) が小さいほど、ひずみ量は大きくなります。
 → 弾性率は、大きくしてください。
 ・基板幅 (w) が小さいほど、ひずみ量は大きくなります。
 → 基板幅は、大きくしてください。
 ・基板厚み (h) が小さいほど、ひずみ量は大きくなります。
 → 基板厚みを大きくしてください。
 基板厚みは、2乗で効くため、ひずみ量への影響が大きくなります。

2. 接着剤塗布

1. 接着剤塗布厚不足の場合、フローはんだ付け時にチップ脱落の原因となりますので、接着剤塗布量は、コンデンサの電極厚とランド厚とを考慮して十分な接着強度が得られるよう図のc寸法以上にしてください。
2. 接着剤粘度不足の場合、チップ実装後の位置ずれの原因となりますので接着剤粘度は5000Pa・s (500ps) 以上 (at 25℃) のものを使用してください。
3. 接着剤塗布量は、下記の値を推奨します。

サイズ (L×W)	塗布量*
1.6×0.8	0.05mg以上
2.0×1.25	0.1mg以上
3.2×1.6	0.15mg以上

*参考値

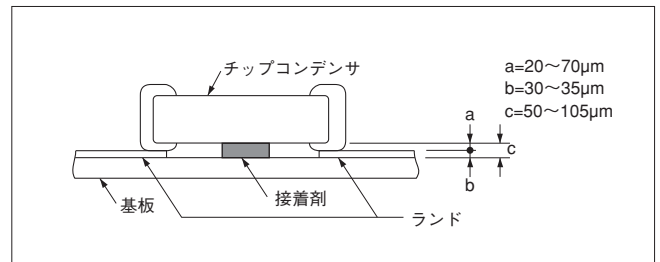

3. 接着剤硬化

1. 接着剤硬化不足の場合、フローはんだ付け時にチップ脱落の原因となります。また接着剤硬化不足の場合、吸湿により外部電極間で絶縁抵抗劣化の原因となりますので、硬化不足とならないよう、接着剤に適した硬化温度と時間を管理してください。

4. フラックス

1. フラックス塗布量が多い場合、フローはんだ付け時にフラックスガスが多量に発生し、はんだ付け性を阻害する原因となりますので、フラックスは薄く均一に塗布するようにしてください。
(フローはんだ付けには発泡方式が一般に用いられます。)
2. フラックス中のハロゲン物質が多いと、洗浄不足の場合、外部電極腐食の原因となりますので、フラックスはハロゲン系物質含有量が0.1%以下のものを使用してください。

3. 酸性の強いものは使用しないでください。
4. 水性フラックス*は使用しないでください。
 (*水性フラックスとは、非ロジン系フラックスを指し、洗浄タイプ非洗浄タイプの双方を含みます。)

次ページに続く ☑

☐ 前ページより続く

5. フローはんだ付け

- 外部電極クワレが、端面部（右図ABCDで囲ったエッジ A-B-C-D辺の全長）の25%以上にならないよう温度、時間を設定してください。

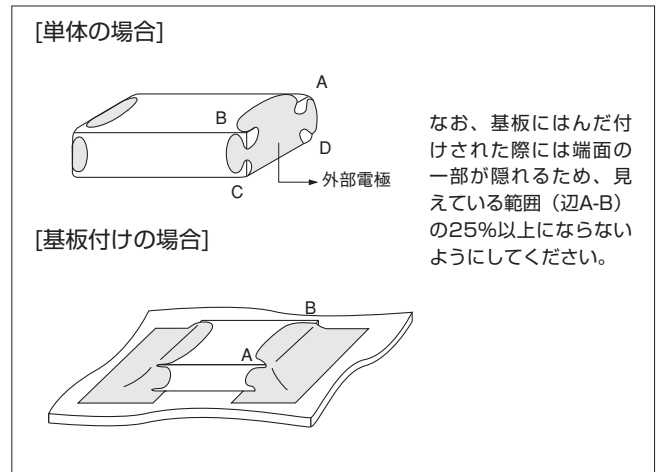

6. 洗浄

1. 洗浄用溶剤は、必ず実洗浄装置を用いて洗浄試験を行い、品質を確認の上選定してください。
2. 洗浄液が不適切な場合は、フラックスの残さその他の異物がコンデンサに付着したり、コンデンサの性能（特に絶縁抵抗）を劣化させる場合があります。
3. コンデンサを洗浄する場合は、洗浄時間などの洗浄条件に制限があります。
 - 3-1. 洗浄条件が不適切（洗浄不足、洗浄過剰）な場合は、コンデンサの性能を損なう場合があります。

7. コーティング

1. コーティング樹脂やモールド樹脂の熱膨張収縮係数は、必ずしもコンデンサの熱膨張収縮係数とは一致しないため、コーティングまたはモールドの硬化処理過程および硬化後の温度変化（熱膨張収縮）によってコンデンサに異常な力加わり、特性または性能が変化したりコンデンサを破損（割れ、外装樹脂のはく離など）させ、絶縁抵抗低下や耐電圧不良にいたる場合があります。
また、コンデンサをモールドする樹脂量が多い場合は、樹脂硬化時の収縮応力によりコンデンサにクラックが発生する可能性があるため、樹脂硬化時の収縮応力の小さいものを使用してください。
2. コーティング材料やモールド材料には、耐湿性を悪化させるものもあるので、十分確認の上、使用してください。
また、湿度の高いところで吸湿性のよい樹脂を使用すると吸湿によるコンデンサの絶縁抵抗劣化になるので、吸湿性の小さいものを使用してください。

次ページに続く ☐

使用上の注意

☐ 前ページより続く

■その他

1. 輸送

1. コンデンサを輸送する場合、条件によって性能に影響を与える場合があります。

1-1. 輸送中、テープ、バルクケースなどの包装形態のものも含め、極端な温度、湿度および機械的な力に対してコンデンサを保護してください。

(1) 気象条件

- ・低温：-40℃
- ・温度の変化 空気/空気：-25℃/+25℃
- ・低気圧：30 kPa
- ・気圧変化の速度：6 kPa/min.

(2) 機械的条件

輸送は、箱が変形せず、また、内部包装物に直接力が伝わらない方法で行ってください。

1-2. コンデンサに過度の振動、衝撃、圧力を加えないでください。

(1) コンデンサの本体はセラミックスなので、過度の機械的衝撃や圧力が加わると、破損やクラックが発生する場合があります。

(2) コンデンサ表面に鋭利なもの（エアドライバー、はんだコテ、ピンセット、シャーシのエッジなど）が強く当たるとショートなどになる場合があります。

1-3. 落下などによって、過度の衝撃が加わったコンデンサは使用しないでください。

落下したコンデンサは、すでに品質が損なわれている場合が多く、故障危険率が高くなる場合があります。

2. 実機での特性評価

1. ご使用に際しては、完成品の性能や規格値に問題がないことを実機にて評価してください。

2. 高誘電率系のセラミックコンデンサの静電容量には電圧依存性や温度依存性があるため、実機内での使用条件によっては静電容量が変化する場合があります。よってコンデンサの静電容量値に影響を受けるもれ電流やノイズ吸収性などの諸特性を必ず実機にて評価してください。

3. また、実機のインダクタンス分により所定のサージを超える電圧がコンデンサに印加されることもあるため、必要に応じ、実機にて耐サージ性の評価を実施してください。

GRMシリーズ

GJMシリーズ

GMAシリーズ

GMDシリーズ

GQMシリーズ

GRJシリーズ

GR3シリーズ

KRMシリーズ

KR3シリーズ

LLAシリーズ

LLLシリーズ

LLMシリーズ

LLRシリーズ

使用上の注意

※ 当カタログに記載の商品を製造している事業所はISO9001
の品質システム認証を取得しています。

事業所名
福井村田製作所
出雲村田製作所
岡山村田製作所
Murata Electronics Singapore (Pte.) Ltd. (シンガポール)
Beijing Murata Electronics Co., Ltd. (中国・北京)
Wuxi Murata Electronics Co., Ltd. (中国・無錫)

設計支援ソフト SimSurfing

Design assistant tool SimSurfing

チップ積層セラミックコンデンサ、高周波用インダクタに対応

オンラインで部品のスペックや特性が確認できる設計支援ソフトSimSurfingが、新たにチップ積層セラミックコンデンサと高周波用インダクタに対応しました。

チップ積層セラミックコンデンサで使える機能

- ① 製品検索機能
- ② 各種周波数特性（Sパラメータ、Z, R, X, Q, DF, L, C）
対応品番においてはDCバイアス印加にも対応
- ③ DCバイアス特性（容量絶対値/変化率）
- ④ 温度特性（容量絶対値/変化率）
- ⑤ AC電圧特性（容量絶対値/変化率）
- ⑥ SPICEネットリスト/Sパラメータダウンロード

会員限定エンジニアポータルサイト「my Murata」に登録すれば、より高機能なSimSurfingをお使いいただけます。
会員登録はこちらへ
<https://my.murata.com/>

1 製品を選択する

製品を検索して選択する際は、
(1) 品番から検索
(2) 特性から検索
が可能です。

2 特性データ表示

品番を選択した状態でボタンを押すと、各種特性がグラフ表示されます。

3 データダウンロード

SPICEネットリストやSパラメータ（S2P）がダウンロードできます。



中・高電圧(250V以上)のコンデンサについて、印加される電圧波形に適合したコンデンサの選択を支援するツールを追加しました。

上記画面は2014年8月時点での操作画面です。このソフトは随時アップデートのため変更されますので、ご注意ください。

<http://ds.murata.co.jp/software/simsurfing/ja/mlcc/>

コンデンサWebサイトのご紹介

muRata

Japan / MURATA MANUFACTURING CO., LTD.

コンデンサ検索

村田製作所のセラミックコンデンサを検索できます。

- 1 品番から探す
- 2 仕様から探す
- 3 特徴から探す
- 4 ラインアップから探す
- 5 クロスリファレンス

1 品番から探す <http://psearch.murata.co.jp/capacitor/partnumber/>

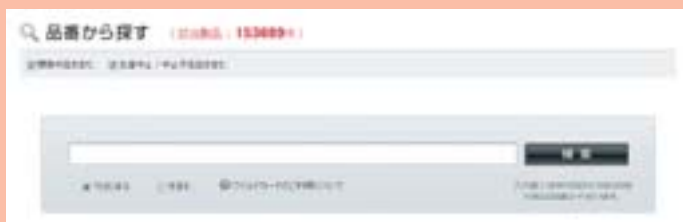

英数文字の品番から該当するコンデンサを検索できます。
包装コードに代替記号「#」を利用しておりますが、正式な包装コードをご入力いただき検索していただいてもその包装コードを含んだ品番にヒットします。

2 仕様から探す <http://psearch.murata.co.jp/capacitor/spec/>

静電容量、定格電圧、温度特性など様々な仕様からコンデンサを検索できます。

基本仕様

任意の値と範囲指定から該当する製品を検索できます。
他項目で選択している条件に該当する製品の最小、最大値が表示され、入力をサポートします。

さらに詳細な仕様

SMD、モールド、リードに特化した条件を設定すれば、より詳細な仕様から検索できます。



3 特徴から探す <http://psearch.murata.co.jp/capacitor/feature/>



形状、最高使用温度、用途、メリット、実装方法から該当するコンデンサを検索できます。

下記項目の条件を選択し検索することができます。

- 「形状」
- 「最高使用温度」
- 「用途」
- 「メリット」
- 「実装方法」

4 ラインアップから探す <http://psearch.murata.co.jp/capacitor/lineup/>

各シリーズのラインアップからその条件に該当するコンデンサを検索できます。

シリーズページではシリーズの特徴や用途などもご確認いただけます。

シリーズページ内の静電容量表

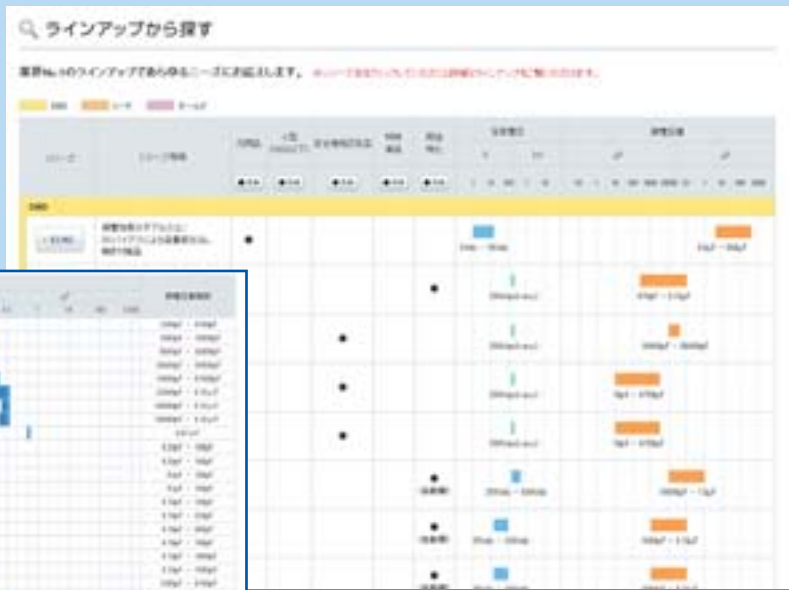
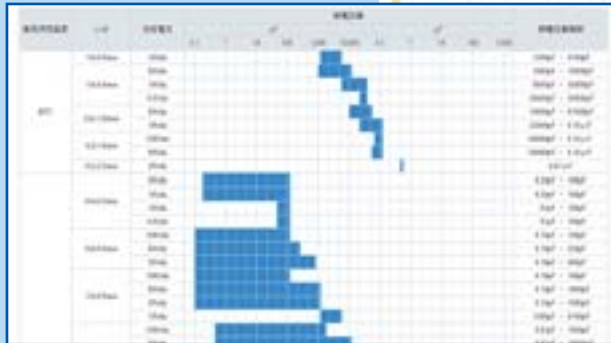

5 クロスリファレンス <http://cross-reference.murata.co.jp/capacitor/crossreference/index.cfm>

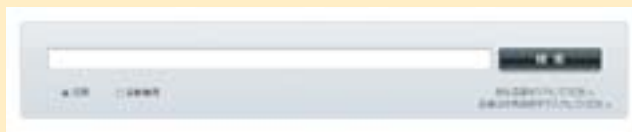

他社チップ積層セラミックコンデンサの品番から推定される仕様に該当するムラタ品番を検索できます。

【検索結果】



現在の検索条件に該当する件数を常時リアルタイムで表示します。

各検索条件ボタンをクリックしていただくとメニューが立ち上がり、選択した条件に合わせて検索結果がリアルタイムに変わっていきます。

「現在の検索条件」をクリックするとメニューが開き、現在の絞り込み条件をご確認いただけます。

検索結果項目の▲印にて結果のソートが可能です。

製品名をクリックすると詳細ページが開き、さらに詳しい情報が入手できます。

詳細ページを開かなくても簡易仕様シートをダウンロードできます。

アイコンで製品のステータスや特徴が一目でわかります。

⚠️お願い

1 当カタログに記載の製品について、その故障や誤動作が人命又は財産に危害を及ぼす恐れがある等の理由により、高信頼性が要求される以下の用途での使用をご検討の場合、又は、当カタログに記載された用途以外での使用をご検討の場合は、必ず事前に弊社営業本部又は最寄りの営業所までご連絡ください。

- ①航空機器
- ②宇宙機器
- ③海底機器
- ④発電所制御機器
- ⑤医療機器
- ⑥輸送機器（自動車、列車、船舶等）
- ⑦交通用信号機器
- ⑧防災／防犯機器
- ⑨情報処理機器
- ⑩その他上記機器と同等の機器

2 当カタログの記載内容は2014年8月現在のものです。記載内容について、改良のため予告なく変更することや供給を停止することがございますので、ご注文に際してはご確認ください。記載内容にご不明の点がございましたら、弊社営業本部又は最寄りの営業所までお問い合わせください。

3 製品によっては、お守りいただかないと発煙、発火等に至る可能性のある定格や△注意（保管・使用環境、定格上の注意、実装上の注意、取扱上の注意）を記載しておりますので、必ずご覧ください。

4 当カタログには、代表的な仕様しか記載しておりませんので、ご注文にあたっては詳細な仕様が記載されている納入仕様書の内容をご確認ください。

5 当カタログに記載の製品の使用もしくは当カタログに記載の情報の使用に際して、弊社もしくは第三者の知的財産権その他の権利にかかわる問題が発生した場合は、弊社はその責を負うものではありません。また、これらの権利の実施権の許諾を行うものではありません。

6 当カタログに記載の製品のうち、「外国為替及び外国貿易法」に定める規制貨物等に該当するものについては、輸出する場合、同法に基づく輸出許可が必要です。

7 弊社の製造工程では、モントリオール議定書で規制されているオゾン層破壊物質（ODS）は一切使用しておりません。