

# Product Specification

(Preliminary)

**Part Name:** Monochrome LCD Display Module

**Part No.:** BCB2004-03 SERIES

**Doc No.:** SAS1-1130-A

<b>Customer:</b>
Approved by:

<b>From:</b> Blaze Display Technology Co., Ltd.
Approved by:

**Blaze Display Technology Co., Ltd.**

5/F, HSAE Tech Building, Hi-Tech Park, Nanshan, Shenzhen, China, 518057

[Http://www.blazedisplay.com](http://www.blazedisplay.com)

**Notes:**

1. Please contact Blaze Display Technology Co., Ltd. before assigning your product based on this module specification
2. The information contained herein is presented merely to indicate the characteristics and performance of our products. No responsibility is assumed by Blaze Display Technology Co., Ltd. for any intellectual property claims or other problems that may result application based on the module described herein.

*Revised History*

Part Number	Revision	Revision Content	Revised on
BCB2004-03-LY-(SG)PTWD-1.0	1.0	New	Aug 20th, 2011
<b>CONFIDENTIAL</b>			



# CONFIDENTIAL

***Notice:***

No part of this material may be reproduced or duplicated in any form or by any means without the written permission of Blaze Display Technology Co., Ltd. Blaze Display Technology Co., Ltd. reserves the right to make changes to this material without notice. Blaze Display Technology Co., Ltd. does not assume any liability of any kind arising out of any inaccuracies contained in this material or due to its application or use in any product or circuit and, further, there is no representation that this material is applicable to products requiring high level reliability, such as, medical products. Moreover, no license to any intellectual property rights is granted by implication or otherwise, and there is no representation or warranty that anything made in accordance with this material will be free from any patent or copyright infringement of a third party. This material or portions thereof may contain technology or the subject relating to strategic products under the control of Foreign Exchange and Foreign Trade Law of China and may require an export license from the Ministry of International Trade and Industry or other approval from another government agency.

**© Blaze Display Technology Co., Ltd. 2011, All Rights Reserved.**

All other product names mentioned herein are trademarks and/or registered trademarks of their respective companies.



## Contents

<i>Revision History</i> .....	I
<i>Notice</i> .....	II
<i>Contents</i> .....	III
<b>1. Basic Specifications</b> .....	<b>1~2</b>
1.1 Display Specifications .....	1
1.2 Mechanical Specifications .....	1
1.3 Others .....	1
1.4 Mechanical Drawing .....	2
<b>2. Electrical Specifications</b> .....	<b>3~4</b>
2.1 Block Diagram .....	3
2.2 Absolute Maximum Ratings .....	3
2.3 Electrical Characteristics .....	4
2.4 Pin Definition .....	4
<b>3. LED Backlight</b> .....	<b>5</b>
3.1 Power Supply for LED Backlight .....	5
3.2 Electrical Optical Characteristics .....	5
<b>4. Optical Characteristics</b> .....	<b>5~7</b>
4.1 Definition of Viewing Angle .....	5
4.2 Definition of Contrast .....	6
4.3 Definition of Response .....	6
4.4 Measuring Instruments for Electro-optical Characteristics .....	7
<b>5. AC Characteristics and Input Timing Characteristics</b> .....	<b>7~8</b>
5.1 AC Characteristics .....	7
5.2 Write Mode .....	7~8
5.3 Read Mode .....	8
<b>6. Instruction Table</b> .....	<b>9</b>
<b>7. Reliability Specification</b> .....	<b>10</b>
7.1 Contents of Reliability Tests .....	10
7.2 Life Time .....	10
<b>8. Quality Level</b> .....	<b>11~13</b>
8.1 Zone Definition .....	11
8.2 Visual Inspection .....	11
8.3 Standard of Appearance Inspection .....	12-13
<b>9. Package Specifications</b> .....	<b>14</b>
<b>10. Precautions When Using These LCD Display Modules</b> .....	<b>14~16</b>
10.1 Handling Precautions .....	14~15
10.2 Storage Precautions .....	15
10.3 Designing Precautions .....	15
10.4 Precautions When Disposing of the LCD Modules .....	16
10.5 Other Precautions .....	16

## 1. Basic Specifications

### 1.1 Display Specifications

- |                           |                         |
|---------------------------|-------------------------|
| 1) Display Type:          | STN GRAY/ POSITIVE      |
| 2) Display Format:        | 20 Characters × 4 Lines |
| 3) Character Color (ON):  | BLUE                    |
| 4) Background Color (ON): | YELLOW-GREEN            |
| Background Color (OFF):   | Gray                    |
| 5) Drive Method:          | 1/16 Duty; 1/5Bias      |
| 6) Viewing Direction:     | 6:00                    |
| 7) Polarizer Type:        | Transflective           |

### 1.2 Mechanical Specifications

- |                        |   |
|------------------------|---|
| 1) Outline Dimensions: | According to the annexed outline drawing on the next page |
| 2) Viewing Area:       | 77.00 W × 25.20 H (mm)                                    |
| 3) Active Area:        | 70.40 W × 20.80 H (mm)                                    |
| 4) Dot Pitch:          | 0.60W × 0.60 H (mm)                                       |
| 5) Dot Size:           | 0.56W × 0.56 H (mm)                                       |
| 6) Weight:             | T.B.D.  |

### 1.3 Others

- |                           |  |
|---------------------------|--|
| 1) Driver IC:             | SPLC780D or EQU  |
| 2) Backlight:             | LED, YELLOW-GREEN, $I_f = 40\text{mA}$ , $V_f = 5.0 \pm 0.2\text{V}$ |
| 3) Operating Temperature: | -20°C – + 70°C   |
| 4) Storage Temperature:   | -30°C – + 80°C   |
| 5) RoHS Compliant:        | Yes  |

**1.4 Mechanical Drawing**

<b>Revised Record</b>	1.0	New issue	2011-08-13			
-----------------------	-----	-----------	------------	--	--	--

INTERFACE:	
1	VSS
2	VCC(5V)
3	V0
4	RS
5	RW
6	E
7	DB0
8	DB1
9	DB2
10	DB3
11	DB4
12	DB5
13	DB6
14	DB7
15	BLA(5V)
16	BLK

**NOTES:**

01. DISPLAY TYPE:	STN(GRAY)/POSITIVE/TRANSFLECTIVE RoHS
02. OPERATING VOLTAGE:	VOP=4.5V,VDD=5.0V
03. OPERATING TEMPERATURE:	-20°C~+70°C
04. STORAGE TEMPERATURE:	-30°C~+80°C
05. DRIVE MODE:	1/16DUTY,1/5BIAS
06. VIEWING DIRECTION:	6:00
07. DRIVE IC:	SPLC780D(OR-EQV)
08. CONNECTOR:	ZEBER
09. BACKLIGHT:	LED(YELLOW-GREEN)
10. CUSTOMER'S PART ID:	BLAZE_STANDARD_PRODUCT

**BLAZE** Blaze Display Technology Co.,Ltd.

DESIGNED BY: BDT-19	BGB2004-03-SERIES	VERSION: 1.0
CHECKED BY: BDT-05		PAGE 1 OF 1
APPROVED BY: BDT-02		UNIT: mm
Website:http://www.blazedisplay.com		DATE: 2011-08-13



## 2. Electrical Specification

### 2.1 Block Diagram

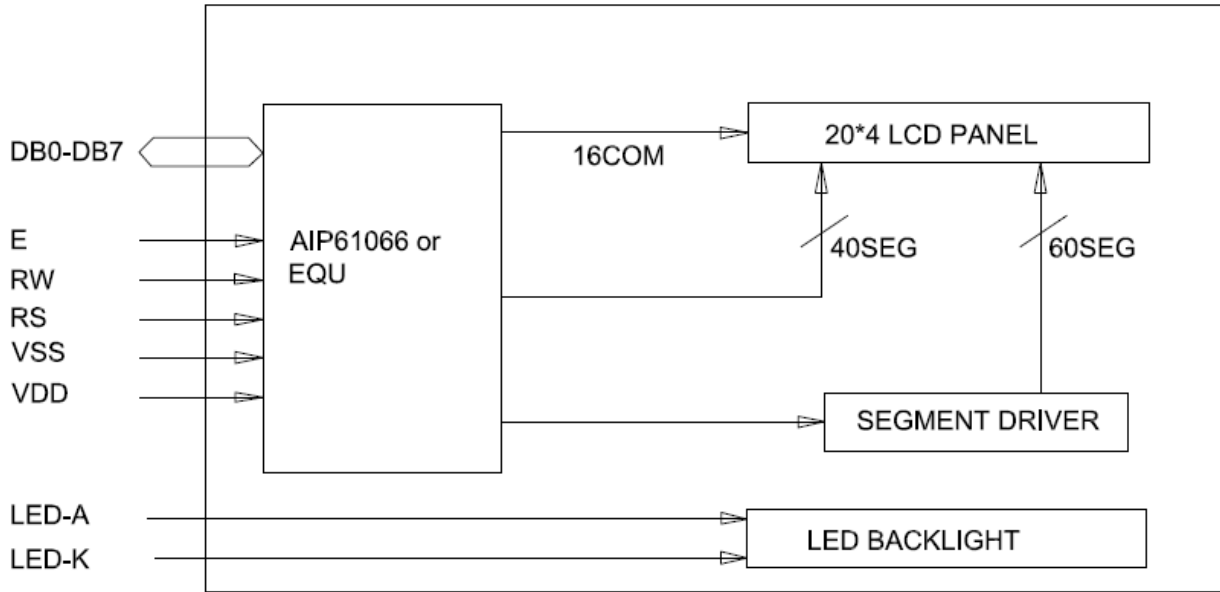

Character located	1	2	3	.....	14	15	16
DDRAM address 1st	00H	01H	02H	.....	11H	12H	13H
DDRAM address 2st	40H	41H	42H	.....	51H	52H	53H
DDRAM address 3st	14H	15H	16H	.....	25H	26H	27H
DDRAM address 4st	54H	55H	56H	.....	65H	66H	67H

### 2.2 Absolute Maximum Ratings

Item	Symbol	Min.	Max.	Unit
Power Supply for Logic	Vdd	-0.3	+5.2	V
Power supply for LCD Drive	Vlcd	Vss + 0.3	Vss + 5.0	V
Input Voltage	Vin	-0.3	Vdd + 0.3	V
Operating Temperature	Topr	-20	+70	°C
Storage Temperature	Tstg	-30	+80	°C

### 2.3 Electrical Characteristics

Ta = 25°C; Vdd = 5.0V, otherwise specified

Characteristics	Symbol	Limit			Unit	Test Condition
		Min.	Typ.	Max.		
Operating Current	IDD	-	0.55	0.8	mA	External clock (Note)
Input High Voltage	V <sub>IH1</sub>	2.2	-	VDD	V	Pins:(E, RS, R/W, DB7 - 0)
Input Low Voltage	V <sub>IL1</sub>	-0.3	-	0.6	V	
Input High Voltage	V <sub>IH2</sub>	VDD-1	-	VDD	V	Pin OSC1
Input Low Voltage	V <sub>IL2</sub>	-0.2	-	1.0	V	Pin OSC1
Input High Current	I <sub>IH</sub>	-2.0	-	2.0	μA	Pins: (RS, R/W, DB7 - 0) VDD = 5.0V
Input Low Current	I <sub>IL</sub>	-20.0	-50.0	-100.0	μA	
Output High Voltage (TTL)	V <sub>OH1</sub>	2.4	-	VDD	V	I <sub>OH</sub> = - 0.1mA Pins: DB7 - 0
Output Low Voltage (TTL)	V <sub>OL1</sub>	-	-	0.4	V	I <sub>OL</sub> = 0.1mA Pins: DB7 - 0
Output High Voltage (CMOS)	V <sub>OH2</sub>	0.9VDD	-	VDD	V	I <sub>OH</sub> = - 40.0μA, Pins: CL1, CL2, M, D
Output Low Voltage (CMOS)	V <sub>OL2</sub>	-	-	0.1VDD	V	I <sub>OL</sub> = 40.0μA, Pins: CL1, CL2, M, D
Driver ON Resistance (COM)	R <sub>COM</sub>	-	-	20.0	KΩ	I <sub>O</sub> = ±50.0μA, V <sub>LCD</sub> = 4.0V Pins: COM16 - 1
Driver ON Resistance (SEG)	R <sub>SEG</sub>	-	-	30.0	KΩ	I <sub>O</sub> = ±50.0μA, V <sub>LCD</sub> = 4.0V Pins: SEG40 - 1
LCD Voltage	V <sub>LCD</sub>	3.0	-	11.0	V	VDD - V5, 1/4 bias or 1/5 bias

Note: F<sub>OSC</sub> = 250.0KHz, VDD = 5.0V, pin E = "L", RS, R/W, DB7 - 0 are open, all outputs are no loads.

### 2.4 Pin Definition

No.	Symbol	Function
1	VSS	Ground (0V) VSS
2	VCC	Supply Voltage for Logic (+5.0V )
3	V0	Contrast Adjustment
4	RS	Data/Instruction Select
5	RW	Read/Write Select
6	E	Enable Signal
7-14	DB0—DB7	Data Bus
15	BLA	LED Power Supply + (5.0V)
16	BLK	LED Power Supply - (0V)





### 3. LED Backlight

#### 3.1 Power Supply for LED Backlight

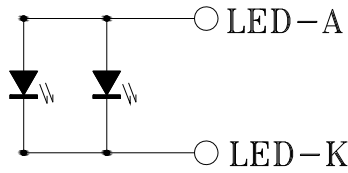

#### 3.2 Electrical Optical Characteristics

Ta = 25°C; Vdd = 5.0V, otherwise specified

Item	Symbol	Conditions	Standard Value			Unit
			Min.	Typ.	Max.	
Forward Voltage	Vf	If = 40mA	4.9	5.0	5.1	V
Reverse Current	Ir	Vr = 5.0V	-	-	100	uA
Spectral Line Half Width	$\Delta\lambda$	IF = 40mA T = 25°C	-	-	-	nm
Peak Wave Length	$\lambda_p$		-	-	-	nm
Luminance	Lv	IF = 40mA	-	30	-	Cd/m <sup>2</sup>
Uniformity	$\Delta$	Min / Max = 100%	-	-	75%	%

### 4. Optical Characteristics

#### 4.1 Definition of Viewing Angle

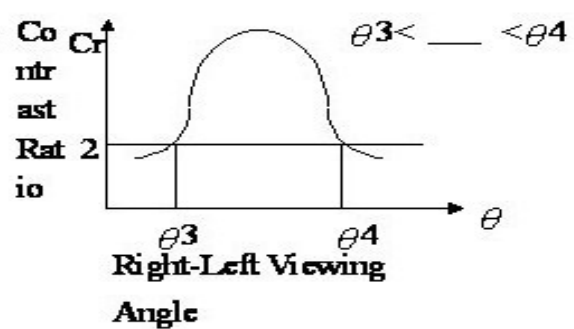
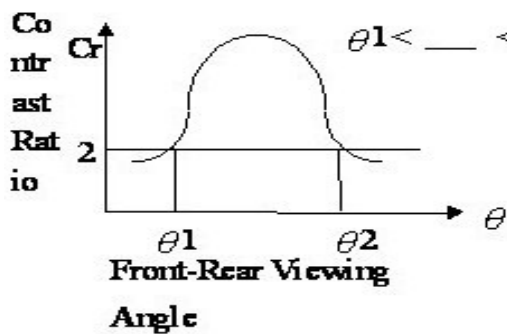
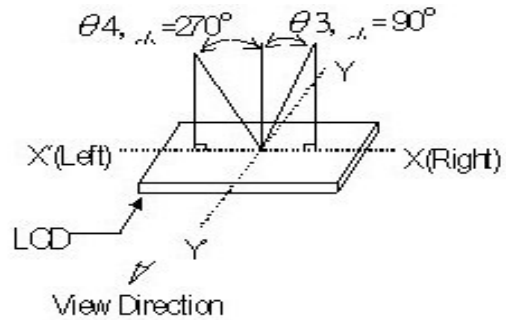
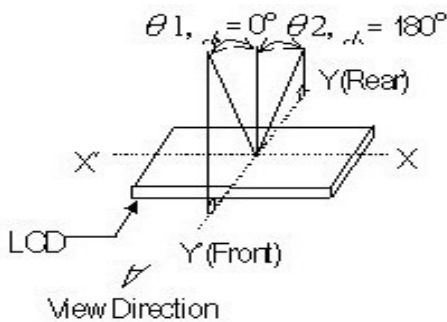

**4.2 Definition of Contrast**

$$C.R = \frac{\text{Brightness of nonselected segment (E2)}}{\text{Brightness of selected segment}}$$

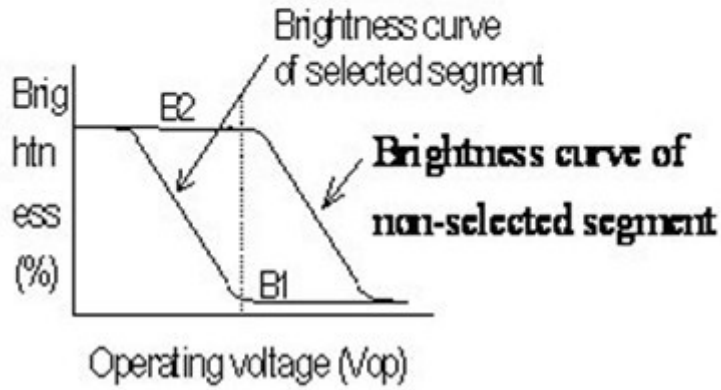

**4.3 Definition of Response**

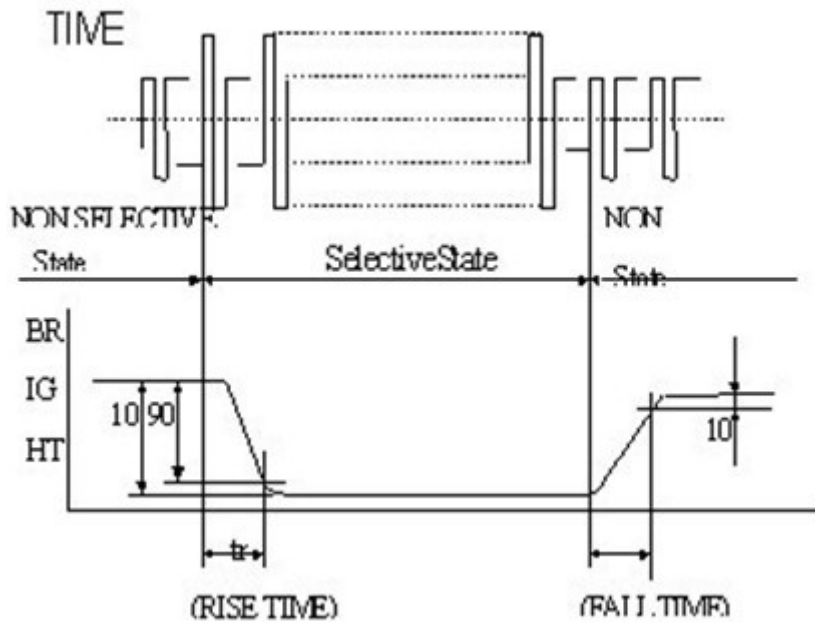

#### 4.4 Measuring Instruments For Electro-optical Characteristics

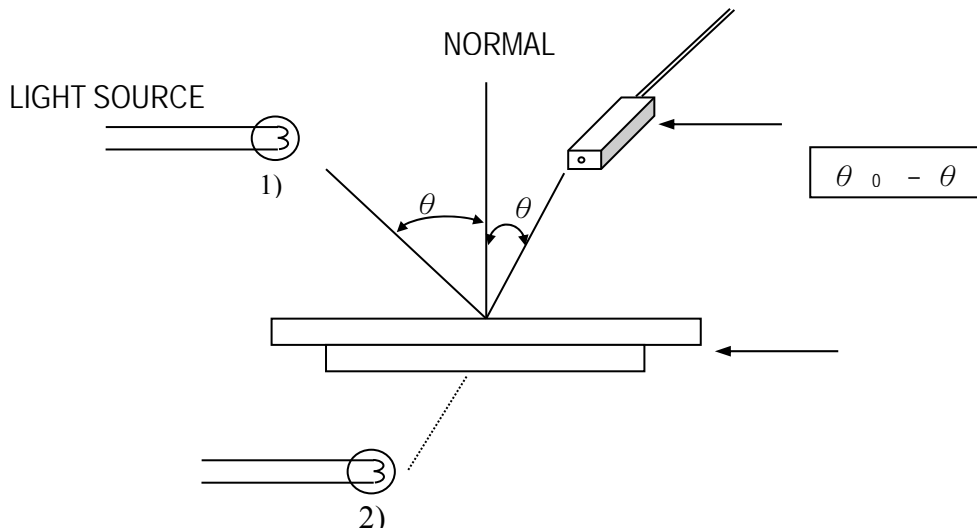

**\* Note:**

- 1) Light source position for measuring the reflective type of LCD panel;
- 2) Light source position for measuring the transmissive / transflective types of LCD panel.

### 5. AC Characteristics and Input Timing Characteristics

#### 5.1 AC characteristics (Vdd=5V, Vss=0V Ta=25°C)

Characteristics	Symbol	Limit			Unit	Test Condition
		Min.	Typ.	Max.		
OSC Frequency	F <sub>OSC1</sub>	190.0	270.0	350.0	KHz	VDD = 5.0V Rf = 91.0KΩ±2%

#### 5.2 Write Mode

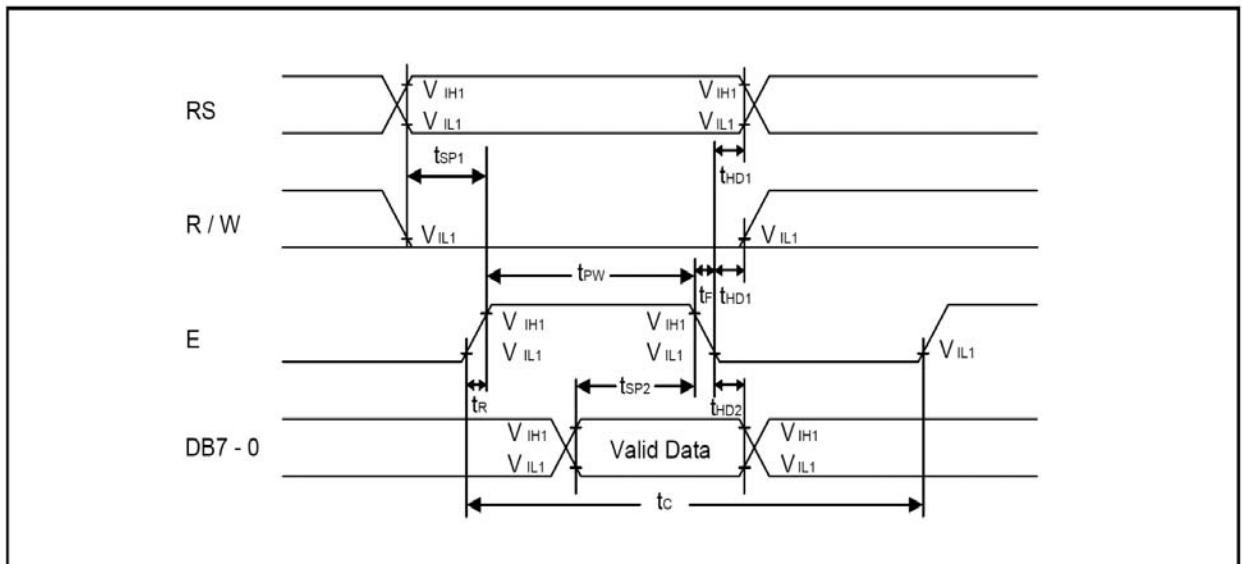

Characteristics	Symbol	Limit			Unit	Test Condition
		Min.	Typ.	Max.		
E Cycle Time	$t_c$	400.0	-	-	ns	Pin E
E Pulse Width	$t_{PW}$	150.0	-	-	ns	Pin E
E Rise/Fall Time	$t_R, t_F$	-	-	25.0	ns	Pin E
Address Setup Time	$t_{SP1}$	30.0	-	-	ns	Pins: RS, R/W, E
Address Hold Time	$t_{HD1}$	10.0	-	-	ns	Pins: RS, R/W, E
Data Setup Time	$t_{SP2}$	40.0	-	-	ns	Pins: DB7 - 0
Data Hold Time	$t_{HD2}$	10.0	-	-	ns	Pins: DB7 - 0

### 5.3 Read Mode

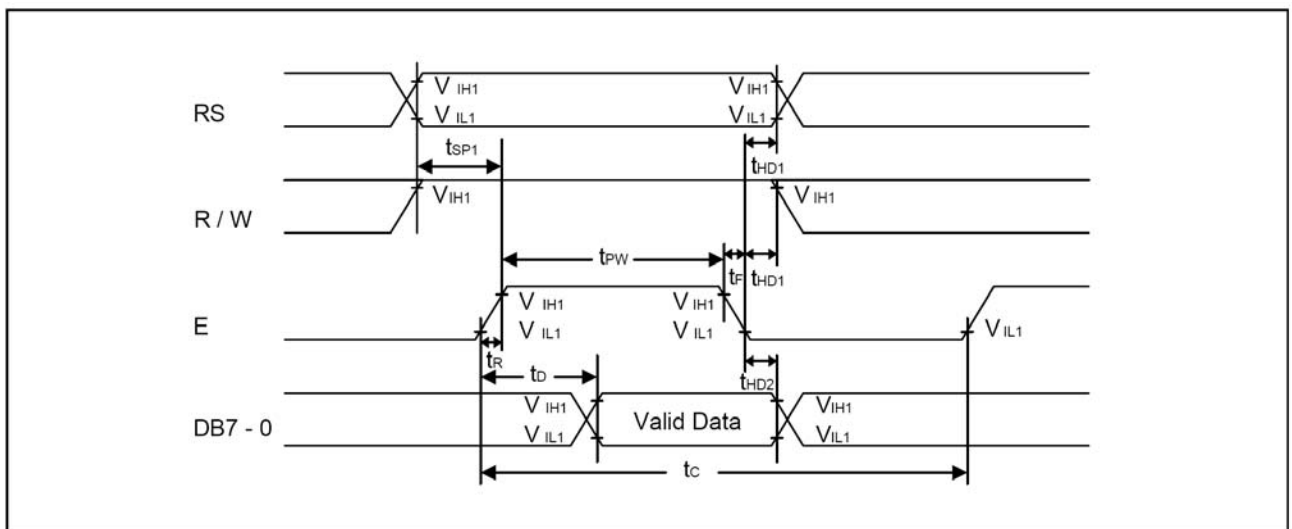

Characteristics	Symbol	Limit			Unit	Test Condition
		Min.	Typ.	Max.		
E Cycle Time	$t_c$	400.0	-	-	ns	Pin E
E Pulse Width	$t_w$	150.0	-	-	ns	Pin E
E Rise/Fall Time	$t_R, t_F$	-	-	25.0	ns	Pin E
Address Setup Time	$t_{SP1}$	30.0	-	-	ns	Pins: RS, R/W,E
Address Hold Time	$t_{HD1}$	10.0	-	-	ns	Pins: RS, R/W,E
Data Output Delay Time	$t_D$	-	-	100.0	ns	Pins: DB7 - 0
Data hold time	$t_{HD2}$	20.0	-	-	ns	Pin DB7 - 0

## 6. Instruction Table

Instruction	Instruction Code										Description	Execution time (F <sub>OSC</sub> = 270KHz)	
	RS	RW	DB7	DB6	DB5	DB4	DB3	DB2	DB1	DB0			
Clear Display	0	0	0	0	0	0	0	0	0	0	1	Write "20H" to DDRAM and set DDRAM address to "00H" from AC	1.52ms
Return Home	0	0	0	0	0	0	0	0	0	1	-	Set DDRAM address to "00H" from AC and return cursor to its original position if shifted. The contents of DDRAM are not changed.	1.52ms
Entry Mode Set	0	0	0	0	0	0	0	0	1	I/D	S	Assign cursor moving direction and enable the shift of entire display	38μs
Display ON/OFF Control	0	0	0	0	0	0	0	1	D	C	B	Set display(D), cursor(C), and blinking of cursor(B) on/off control bit.	38μs
Cursor or Display Shift	0	0	0	0	0	0	1	S/C	R/L	-	-	Set cursor moving and display shift control bit, and the direction, without changing of DDRAM data.	38μs
Function Set	0	0	0	0	0	1	DL	N	F	-	-	Set interface data length (DL: 8-bit/4-bit), numbers of display line (N: 2-line/1-line) and, display font type (F: 5x10 dots/5x8 dots)	38μs
Set CGRAM Address	0	0	0	1	AC5	AC4	AC3	AC2	AC1	AC0		Set CGRAM address in address counter.	38μs
Set DDRAM Address	0	0	1	AC6	AC5	AC4	AC3	AC2	AC1	AC0		Set DDRAM address in counter	38μs
Read Busy Flag and Address Counter	0	1	BF	AC6	AC5	AC4	AC3	AC2	AC1	AC0		Whether during internal operation or not can be known by reading BF. The contents of address counter can also be read.	
Write Data to RAM	1	0	D7	D6	D5	D4	D3	D2	D1	D0		Write data into internal RAM (DDRAM/CGRAM).	38μs
Read Data from RAM	1	1	D7	D6	D5	D4	D3	D2	D1	D0		Read data from internal RAM (DDRAM/CGRAM).	38μs

\* "-": don't care



## 7. Reliability Specification

### 7.1 Contents of Reliability Tests

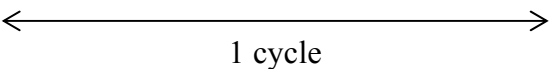
No.	Test Item	Content of Test	Test Condition
1	High Temperature Storage	Endurance test applying the high storage temperature for a long time	+80°C 96H
2	Low Temperature Storage	Endurance test applying the low storage temperature for a long time	-30°C 96H
3	High Temperature Operation	Endurance test applying the electric stress (voltage & current) and the thermal stress to the element for a long time	+70°C 96H
4	Low Temperature Operation	Endurance test applying the electric stress under low temperature for a long time	-20°C 96H
5	High Temperature/ Humidity Storage	Endurance test applying the high temperature and humidity storage for a long time	40°C 90%RH 96H
6	Temperature Cycle	Endurance test applying the low and high temperature cycle $-20^{\circ}\text{C} \longleftrightarrow 25^{\circ}\text{C} \longleftrightarrow 70^{\circ}\text{C} \longleftrightarrow 25^{\circ}\text{C}$ 30min      5min      30min      5min  1 cycle	-20°C/70°C 10 cycles
7	Vibration Test (Package State)	Endurance test applying the vibration during transportation	10Hz—55Hz, 50m/s,15min
8	Shock Test (Package State)	Endurance test applying the shock during transportation	Half-sinewave, 100m/s, 11ms
9	Atmospheric Pressure Test	Endurance test applying the atmospheric pressure during transportation by air	40 kPa 16 H

### 7.2 Life Time

Item	Description
1	Function, performance, appearance, etc. shall be free from remarkable deterioration within 50,000 hours under ordinary operating and storage conditions of room temperature (25±10°C), normal humidity (45±20% RH), and in area not exposed to direct sunlight.

**\* Note: Test Condition**

- 1) Temperature and humidity: If no specification, Temperature set at 25±2°C, Humidity set at 60±5%RH;
- 2) Operating state: Samples subject to the tests shall be in “ Operating ” condition.

## 8. Quality Level

### 8.1 Zone Definition

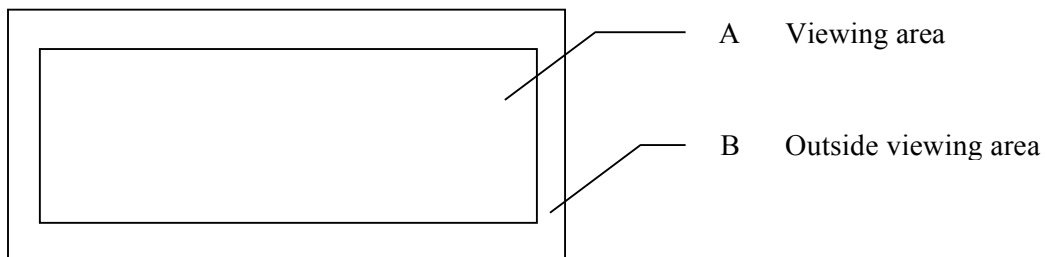

### 8.2 Visual Inspection

- 1) Inspect under 2x20W or 40W fluorescent lamp (approximately 3000 lux) leaving 25 to 30 cm between the module and the lamp and 30 cm between the module and the eye (measuring position).
- 2) Appearance is inspected at the best contrast voltage (best contrast is adjusted considering clearness and crosstalk on screen).
- 3) Inspect the module at 45° right and left, top and bottom.
- 4) Use the optimum viewing angle during the contrast inspection.

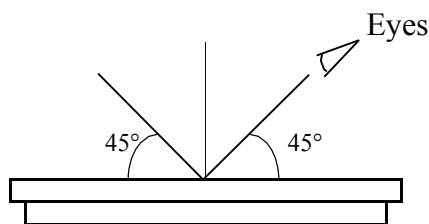

**8.3 Standard of Apperance Inspection**

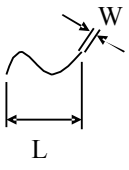
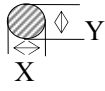
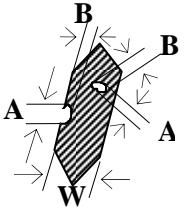
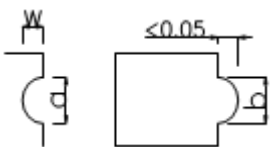
No.	Item	Criteria																																			
1	Black spot White spot Dust	<p>Round type: as per following drawing  <math>\Phi = (X+Y)/2</math></p>  <table border="1" style="margin-left: 200px;"> <thead> <tr> <th colspan="3">Acceptable quantity</th> </tr> <tr> <th>Size</th> <th>Zone A</th> <th>Zone B</th> </tr> </thead> <tbody> <tr> <td><math>\Phi &lt; 0.1</math></td> <td>Any number</td> <td rowspan="4">Any number</td> </tr> <tr> <td><math>0.1 &lt; \Phi &lt; 0.2</math></td> <td>2</td> </tr> <tr> <td><math>0.2 &lt; \Phi &lt; 0.25</math></td> <td>1</td> </tr> <tr> <td><math>0.25 &lt; \Phi</math></td> <td>0</td> </tr> </tbody> </table> <p>Line type: as per following drawing</p>  <table border="1" style="margin-left: 200px;"> <thead> <tr> <th colspan="4">Acceptable quantity</th> </tr> <tr> <th>Length</th> <th>Width</th> <th>Zone A</th> <th>Zone B</th> </tr> </thead> <tbody> <tr> <td>—</td> <td><math>W \leq 0.02</math></td> <td>Any number</td> <td rowspan="4">Any number</td> </tr> <tr> <td><math>L \leq 3.0</math></td> <td><math>0.02 &lt; W \leq 0.03</math></td> <td rowspan="2">2</td> </tr> <tr> <td><math>L \leq 2.5</math></td> <td><math>0.03 &lt; W \leq 0.05</math></td> </tr> <tr> <td>—</td> <td><math>0.05 &lt; W</math></td> <td>As round type</td> </tr> </tbody> </table> <p>Total acceptable quantity: 3</p>	Acceptable quantity			Size	Zone A	Zone B	$\Phi < 0.1$	Any number	Any number	$0.1 < \Phi < 0.2$	2	$0.2 < \Phi < 0.25$	1	$0.25 < \Phi$	0	Acceptable quantity				Length	Width	Zone A	Zone B	—	$W \leq 0.02$	Any number	Any number	$L \leq 3.0$	$0.02 < W \leq 0.03$	2	$L \leq 2.5$	$0.03 < W \leq 0.05$	—	$0.05 < W$	As round type
Acceptable quantity																																					
Size	Zone A	Zone B																																			
$\Phi < 0.1$	Any number	Any number																																			
$0.1 < \Phi < 0.2$	2																																				
$0.2 < \Phi < 0.25$	1																																				
$0.25 < \Phi$	0																																				
Acceptable quantity																																					
Length	Width	Zone A	Zone B																																		
—	$W \leq 0.02$	Any number	Any number																																		
$L \leq 3.0$	$0.02 < W \leq 0.03$	2																																			
$L \leq 2.5$	$0.03 < W \leq 0.05$																																				
—	$0.05 < W$	As round type																																			
2	Polariser scratch	Scratch on protective film is permitted Scratch on polariser: same as No. 1																																			
3	Polariser bubble	<p><math>\Phi = (X+Y)/2</math></p>  <table border="1" style="margin-left: 200px;"> <thead> <tr> <th colspan="3">Acceptable quantity</th> </tr> <tr> <th>Size</th> <th>Zone A</th> <th>Zone B</th> </tr> </thead> <tbody> <tr> <td><math>\Phi &lt; 0.2</math></td> <td>Any number</td> <td rowspan="4">Any number</td> </tr> <tr> <td><math>0.2 &lt; \Phi &lt; 0.5</math></td> <td>2</td> </tr> <tr> <td><math>0.5 &lt; \Phi &lt; 1.0</math></td> <td>1</td> </tr> <tr> <td><math>1.0 &lt; \Phi</math></td> <td>0</td> </tr> </tbody> </table> <p>Total acceptable quantity: 3</p>	Acceptable quantity			Size	Zone A	Zone B	$\Phi < 0.2$	Any number	Any number	$0.2 < \Phi < 0.5$	2	$0.5 < \Phi < 1.0$	1	$1.0 < \Phi$	0																				
Acceptable quantity																																					
Size	Zone A	Zone B																																			
$\Phi < 0.2$	Any number	Any number																																			
$0.2 < \Phi < 0.5$	2																																				
$0.5 < \Phi < 1.0$	1																																				
$1.0 < \Phi$	0																																				
4	Segment deformation	<p>4.1 Pin hole on segmented display  W: segment width  <math>\Phi = (A+B)/2</math></p>  <table border="1" style="margin-left: 200px;"> <thead> <tr> <th colspan="2">Acceptable quantity</th> </tr> <tr> <th>Width</th> <th>Quantity</th> </tr> </thead> <tbody> <tr> <td><math>W \leq 0.4</math></td> <td><math>\Phi \leq 0.2</math> and <math>\Phi \leq 1/2W</math></td> </tr> <tr> <td><math>W &gt; 0.4</math></td> <td><math>\Phi \leq 0.25</math> and <math>\Phi \leq 1/3W</math></td> </tr> </tbody> </table> <p>Total acceptable quantity: 1 defect per segment Pin holes with <math>\Phi</math> under 0.10 mm are acceptable</p> <p>4.2 Pin hole on dot matrix display</p>  <table border="1" style="margin-left: 200px;"> <thead> <tr> <th colspan="2">Acceptable quantity</th> </tr> <tr> <th>Size</th> <th>Quantity</th> </tr> </thead> <tbody> <tr> <td>a, b &lt; 0.1</td> <td>Any number</td> </tr> <tr> <td><math>(a+b)/2 \leq 0.1</math></td> <td>Any number</td> </tr> <tr> <td><math>0.5 &lt; \Phi &lt; 1.0</math></td> <td>3</td> </tr> </tbody> </table> <p>Total acceptable quantity: 7</p>	Acceptable quantity		Width	Quantity	$W \leq 0.4$	$\Phi \leq 0.2$ and $\Phi \leq 1/2W$	$W > 0.4$	$\Phi \leq 0.25$ and $\Phi \leq 1/3W$	Acceptable quantity		Size	Quantity	a, b < 0.1	Any number	$(a+b)/2 \leq 0.1$	Any number	$0.5 < \Phi < 1.0$	3																	
Acceptable quantity																																					
Width	Quantity																																				
$W \leq 0.4$	$\Phi \leq 0.2$ and $\Phi \leq 1/2W$																																				
$W > 0.4$	$\Phi \leq 0.25$ and $\Phi \leq 1/3W$																																				
Acceptable quantity																																					
Size	Quantity																																				
a, b < 0.1	Any number																																				
$(a+b)/2 \leq 0.1$	Any number																																				
$0.5 < \Phi < 1.0$	3																																				

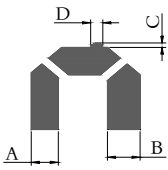
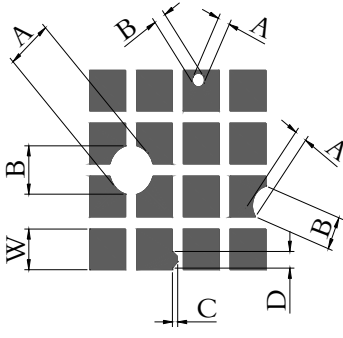

		<p>4.3 Segments / dots with different width</p>  <table border="1" data-bbox="938 273 1292 371"> <thead> <tr> <th colspan="2">Acceptable</th> </tr> </thead> <tbody> <tr> <td>a ≥ b</td> <td>a/b ≤ 4/3</td> </tr> <tr> <td>a &lt; b</td> <td>a/b &gt; 4/3</td> </tr> </tbody> </table> <p>4.4 Alignment layer defect</p> <p><math>\Phi = (A+B)/2</math></p>  <table border="1" data-bbox="944 577 1299 797"> <thead> <tr> <th colspan="2">Acceptable quantity</th> </tr> <tr> <th>Size</th> <th></th> </tr> </thead> <tbody> <tr> <td><math>\Phi \leq 0.4</math></td> <td>Any number</td> </tr> <tr> <td><math>0.4 &lt; \Phi \leq 1.0</math></td> <td>5</td> </tr> <tr> <td><math>1.0 &lt; \Phi \leq 1.5</math></td> <td>3</td> </tr> <tr> <td><math>1.5 &lt; \Phi \leq 2.0</math></td> <td>2</td> </tr> </tbody> </table> <p>Total acceptable quantity: 7</p>	Acceptable		a ≥ b	a/b ≤ 4/3	a < b	a/b > 4/3	Acceptable quantity		Size		$\Phi \leq 0.4$	Any number	$0.4 < \Phi \leq 1.0$	5	$1.0 < \Phi \leq 1.5$	3	$1.5 < \Phi \leq 2.0$	2
Acceptable																				
a ≥ b	a/b ≤ 4/3																			
a < b	a/b > 4/3																			
Acceptable quantity																				
Size																				
$\Phi \leq 0.4$	Any number																			
$0.4 < \Phi \leq 1.0$	5																			
$1.0 < \Phi \leq 1.5$	3																			
$1.5 < \Phi \leq 2.0$	2																			
5	Colour uniformity	Level of sample for approval set as limit sample																		
6	Backlight	The backlight colour should correspond to the product specification Flashing and or unlit backlight is not allowed Dust larger than 0.25 mm is not allowed																		
7	COB	Exposed wire bond pad is not allowed Insufficient covering with resin is not allowed (wire bond line exposed) Dust or bubble on the resin are not allowed																		
8	PCB	No unmelted solder paste should be present on PCB Cold solder joints, missing solder connections, or oxidation are not allowed No residue or solder balls on PCB are allowed Short circuits on components are not allowed																		
9	Tray particles	<table border="1" data-bbox="686 1339 1212 1545"> <thead> <tr> <th colspan="3">Acceptable quantity</th> </tr> <tr> <th></th> <th>Size</th> <th>Quantity</th> </tr> </thead> <tbody> <tr> <td rowspan="2">On tray</td> <td><math>\Phi &lt; 0.2</math></td> <td>Any number</td> </tr> <tr> <td><math>\Phi &gt; 0.25</math></td> <td>4</td> </tr> <tr> <td rowspan="2">On display</td> <td><math>\Phi \geq 0.25</math></td> <td>2</td> </tr> <tr> <td>L = 3</td> <td>1</td> </tr> </tbody> </table>	Acceptable quantity				Size	Quantity	On tray	$\Phi < 0.2$	Any number	$\Phi > 0.25$	4	On display	$\Phi \geq 0.25$	2	L = 3	1		
Acceptable quantity																				
	Size	Quantity																		
On tray	$\Phi < 0.2$	Any number																		
	$\Phi > 0.25$	4																		
On display	$\Phi \geq 0.25$	2																		
	L = 3	1																		

## 9. Package Specifications

T.B.D.

## 10. Precautions When Using These LCD Modules

### 10.1 Handling Precautions

- 1) Since the display panel is being made of glass, do not apply mechanical impacts such as dropping from a high position.
- 2) If the display panel is broken by some accident and the internal organic substance leaks out, be careful not to inhale nor lick the organic substance.
- 3) If pressure is applied to the display surface or its neighborhood of the LCD Module, the cell structure may be damaged and be careful not to apply pressure to these sections.
- 4) The polarizer covering the surface of the LCD Module is soft and easily scratched. Please be careful when handling the LCD Module.
- 5) When the surface of the polarizer of the LCD Module has soil, clean the surface. It takes advantage of by using following adhesion tape.
  - \* Scotch Mending Tape No. 810 or an equivalent.Never try to breathe upon the soiled surface nor wipe the surface using cloth containing solvent such as ethyl alcohol, since the surface of the polarizer will become cloudy.  
Also, pay attention that the following liquid and solvent may spoil the polarizer:
  - \* Water
  - \* Ketone
  - \* Aromatic Solvents
- 6) Hold LCD Module very carefully when placing LCD Module into the system housing. Do not apply excessive stress or pressure to LCD Module. And, do not over bend the film with electrode pattern layouts. These stresses will influence the display performance. Also, secure sufficient rigidity for the outer cases.

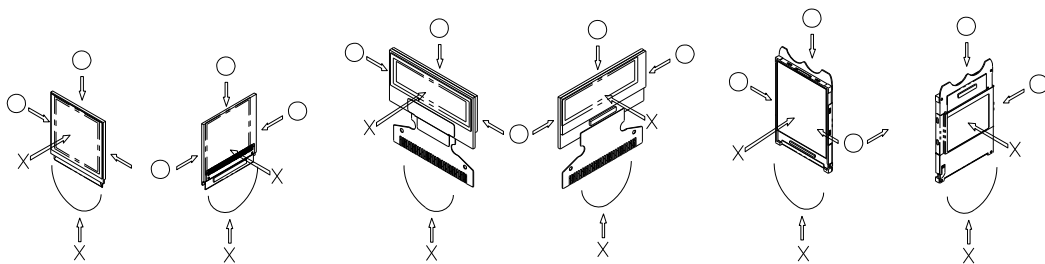

- 7) Do not apply stress to the LSI chips and the surrounding molded sections.
- 8) Do not disassemble nor modify the LCD Module.
- 9) Do not apply input signals while the logic power is off.
- 10) Pay sufficient attention to the working environments when handling LCD Modules to prevent occurrence of element breakage accidents by static electricity.
  - \* Be sure to make human body grounding when handling LCD Modules.
  - \* Be sure to ground tools to use or assembly such as soldering irons.
  - \* To suppress generation of static electricity, avoid carrying out assembly work under dry environments.
  - \* Protective film is being applied to the surface of the display panel of the LCD

Module. Be careful since static electricity may be generated when exfoliating the protective film.

- \* Protective film is being applied to the surface of the display panel of the LCD Module. Be careful since static electricity may be generated when exfoliating the protective film
- 11) Protection film is being applied to the surface of the display panel and removes the protection film before assembling it. At this time, if the LCD Module has been stored for a long period of time, residue adhesive material of the protection film may remain on the surface of the display panel after removed of the film. In such case, remove the residue material by the method introduced in the above Section 5).
- 12) If electric current is applied when the LCD Module is being dewed or when it is placed under high humidity environments, the electrodes may be corroded and be careful to avoid the above.

## 10.2 Storage Precautions

- 1) When storing LCD Modules, put them in static electricity preventive bags avoiding exposure to direct sun light nor to lights of fluorescent lamps. and, also, avoiding high temperature and high humidity environment or low temperature (less than 0°C) environments. (We recommend you to store these modules in the packaged state when they were shipped from Blaze Display Technology Co., Ltd.)  
At that time, be careful not to let water drops adhere to the packages or bags nor let dewing occur with them.
- 2) If electric current is applied when water drops are adhering to the surface of the LCD Module, when the LCD Module is being dewed or when it is placed under high humidity environments, the electrodes may be corroded and be careful about the above.

## 10.3 Designing Precautions

- 1) The absolute maximum ratings are the ratings which can not be exceeded for LCD Module, and if these values are exceeded, panel damage may be happen.
- 2) To prevent occurrence of malfunctioning by noise, pay attention to satisfy the VIL and VIH specifications and, at the same time, to make the signal line cable as short as possible.
- 3) We recommend you to install excess current preventive unit (fuses, etc.) to the power circuit (VDD). (Recommend value: 0.5A)
- 5) Pay sufficient attention to avoid occurrence of mutual noise interference with the neighboring devices.
- 6) As for EMI, take necessary measures on the equipment side basically.  
When fastening the LCD Module, fasten the external plastic housing section.
- 7) If power supply to the LCD Module is forcibly shut down by such errors as taking out the main battery while the LCD Panel is in operation, we cannot guarantee the quality of this LCD Module.
- 8) The electric potential to be connected to the rear face of the IC chip should be as follows:
  - \* Connection (contact) to any other potential than the above may lead to rupture of the IC.

## 10.4 Precautions When Disposing of the LCD Modules

Request the qualified companies to handle industrial wastes when disposing of the LCD Modules. Or, when burning them, be sure to observe the environmental and hygienic laws and regulations.

## 10.5 Other Precautions

- 1) When a LCD Module is operated for a long of time with fixed pattern may remain as an after image or slight contrast deviation may occur.  
Nonetheless, if the operation is interrupted and left unused for a while, normal state can be restored. Also, there will be no problem in the reliability of the module
- 2) To protect LCD Modules from performance drops by static electricity rapture, etc., do not touch the following sections whenever possible while handling the LCD Modules.
  - \* Pins and electrodes
  - \* Pattern layouts such as the TCP & FPC
- 3) With this LCD Module, the LCD Module driver is being exposed. Generally speaking, semiconductor elements change their characteristics when light is radiated according to the principle of the solar battery. Consequently, if this LCD Module driver is exposed to light, malfunctioning may occur.
  - \* Design the product and installation method so that the LCD Module driver may be shielded from light in actual usage.
  - \* Design the product and installation method so that the LCD Module driver may be shielded from light during the inspection processes.
- 4) Although this LCD Module stores the operation state data by the commands and the indication data, when excessive external noise, etc. enters into the module, the internal status may be changed to take appropriate measures to suppress noise generation or to protect from influences of noise on the system design.
- 5) We recommend you to construct its software to make periodical refreshment of the operation statuses (re-setting of the commands and re-transference of the display data) to cope with catastrophic noise.