

LCD Display PID Control Temperature Controller

■ Features

- Super high-speed sampling with 50ms
- Improved visibility with LCD display
- Communication function supported: RS485 (Modbus RTU)
- **Convenient parameter setting** (RS485 communication)
 - : Free download the comprehensive device management program (DAQMaster)
- SSR drive output / Current output selectable
- SSRP output (standard/phase/cycle control selectable)
- Mounting space saving with compact design
 - : downsized by approx. 30% in depth compared with same size of other Series (panel back length: 45mm)



! Please read "Safety Considerations" in operation manual before using.



■ Manual

For the detail information and instructions of communication setting and Modbus mapping table, please refer to user manual for communication, and be sure to follow cautions written in the technical descriptions (catalog, homepage). Visit our homepage (www.autonics.com) to download manuals.

■ Comprehensive Device Management Program (DAQMaster)

- DAQMaster is comprehensive device management program. It is available for parameter setting, monitoring.
- Visit our website (www.autonics.com) to download user manual and comprehensive device management program.

< Computer specification for using software >

Item	Minimum requirements
System	IBM PC compatible computer with Intel Pentium III or above
Operating system	Microsoft Windows 98/NT/XP/Vista/7/8/10
Memory	256MB or more
Hard disk	More than 1GB of free hard disk space
VGA	1024×768 or higher resolution display
Others	RS-232 serial port (9-pin), USB port

< DAQMaster screen >

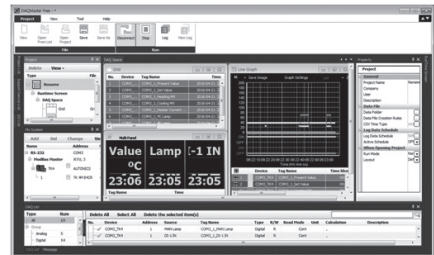

■ Ordering Information

TX 4 S - 1 4 R

Control output	R	Relay output
	S	SSR drive output
	C	Selectable current output or SSR drive output
Power supply	4	100-240VAC 50/60Hz
Option output	1	Alarm output 1
	2	Alarm output 1+Alarm output 2
	A	Alarm output 1+Alarm output 2+Trans. output
	B	Alarm output 1+Alarm output 2+RS485 com. output
Size	S	DIN W48×H48mm
	M	DIN W72×H72mm
	H	DIN W48×H96mm
	L	DIN W96×H96mm
Digit	4	9999 (4-digit)
Item	TX	LCD display standard PID temperature controller

(A) Photoelectric Sensors

(B) Fiber Optic Sensors

(C) Door/Area Sensors

(D) Proximity Sensors

(E) Pressure Sensors

(F) Rotary Encoders

(G) Connectors/ Connector Cables/ Sensor Distribution Boxes/Sockets

(H) Temperature Controllers

(I) SSRs / Power Controllers

(J) Counters

(K) Timers

(L) Panel Meters

(M) Tacho / Speed / Pulse Meters

(N) Display Units

(O) Sensor Controllers

(P) Switching Mode Power Supplies

(Q) Stepper Motors & Drivers & Controllers





(R) Graphic/ Logic Panels

(S) Field Network Devices

(T) Software

TX Series

■ Specifications

Series		TX4S	TX4M	TX4H	TX4L
Power supply		100-240VAC ~ 50/60Hz			
Allowable voltage range		90 to 110% of rated voltage			
Power consumption		Max. 8VA			
Display method		11-segment (PV: white, SV: green), other display (yellow) with LCD method ^{※1}			
Character size	PV(W×H)	7.2×14mm	10.7×17.3mm	7.2×15.8mm	16×26.8mm
	SV(W×H)	3.9×7.6mm	6.8×11mm	6.2×13.7mm	10.7×17.8mm
Input type	RTD	DPT100Ω, Cu50Ω (permissible line resistance max. 5Ω)			
	TC	K(CA), J(IC), L(IC), T(CC), R(PR), S(PR)			
Display accuracy ^{※2}	RTD	●At room temperature (23°C±5°C): (PV ±0.3% or ±1°C, select the higher one) ±1-digit			
	TC	●Out of room temperature: (PV ±0.5% or ±2°C, select the higher one) ±1-digit			
Control output	Relay	250VAC ~ 3A, 30VDC = 3A, 1a			
	SSR	Max. 12VDC = ±2V 20mA	Max. 13VDC = ±3V 20mA		
	Current	DC4-20mA or DC0-20mA (load resistance max. 500Ω)			
Option output	Alarm output	AL1, AL2 Relay: 250VAC ~ 3A 1a			
	Trans. output	DC4-20mA (load resistance max. 500Ω, output accuracy: ±0.3%F.S.)			
	Com. output	RS485 Communication output (Modbus RTU method)			
Control method		ON/OFF control, P, PI, PD, PID control			
Hysteresis		1 to 100°C/°F (0.1 to 50.0°C/°F) variable			
Proportional band(P)		0.1 to 999.9°C/°F			
Integral time(I)		0 to 9999 sec			
Derivative time(D)		0 to 9999 sec			
Control period(T)		0.5 to 120.0 sec			
Manual reset		0.0 to 100.0%			
Sampling period		50ms			
Dielectric strength		3,000VAC 50/60Hz for 1 min (between all terminals and case)			
Vibration		0.75mm amplitude at frequency 5 to 55Hz (for 1 min) in each X, Y, Z direction for 2 hours			
Relay life cycle	Mechanical	OUT, AL1/2: min. 5,000,000 operations			
	Electrical	OUT, AL1/2: min. 200,000 (250VAC 3A resistance load)			
Insulation resistance		Over 100MΩ (at 500VDC megger)			
Noise immunity		Square shaped noise by noise simulator (pulse width 1μs) ±2kV R-phase, S-phase			
Memory retention		Approx. 10 years (non-volatile semiconductor memory type)			
Environment	Ambient temp.	-10 to 50°C, storage: -20 to 60°C			
	Ambient humi.	35 to 85%RH, storage: 35 to 85%RH			
Protection structure		IP50 (front panel, IEC standards)			
Insulation type		Double insulation or reinforced insulation(mark:  , dielectric strength between all terminals and case: 3kV)			
Approval		  			
Weight ^{※3}		Approx. 146.1g (approx. 86.7g)	Approx. 233g (approx. 143g)	Approx. 214g (approx. 133g)	Approx. 290g (approx. 206g)

※1: When using the unit at low temperature (below 0°C), display cycle is slow.

Control output operates normally.

※2: ○ At room temperature(23°C±5°C)

- TC R(PR), S(PR), below 200°C: (PV ±0.5% or ±3°C, select the higher one) ±1-digit
- TC L(IC), RTD Cu50Ω: (PV ±0.5% or ±2°C, select the higher one) ±1-digit

○ Out of room temperature range

- TC R(PR), S(PR): (PV ±1.0% or ±5°C, select the higher one) ±1-digit
- TC L(IC), RTD Cu50Ω: (PV ±0.5% or ±3°C, select the higher one) ±1-digit

※3: The weight includes packaging. The weight in parenthesis is for unit only.

※Environment resistance is rated at no freezing or condensation.

LCD Display PID Control

■ Dimensions

(unit: mm)

● TX4S

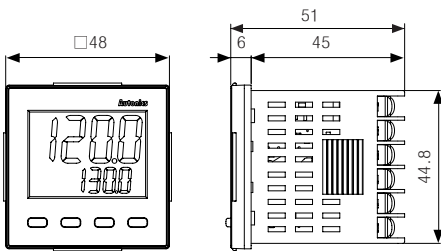

● TX4M

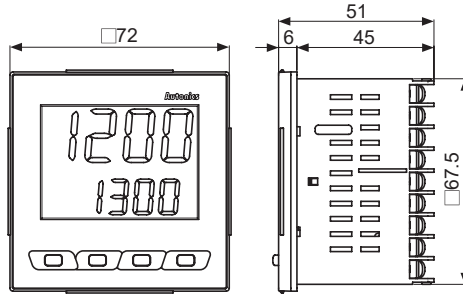

● TX4H

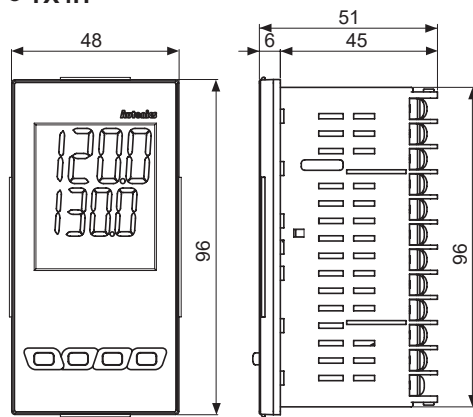

● TX4L

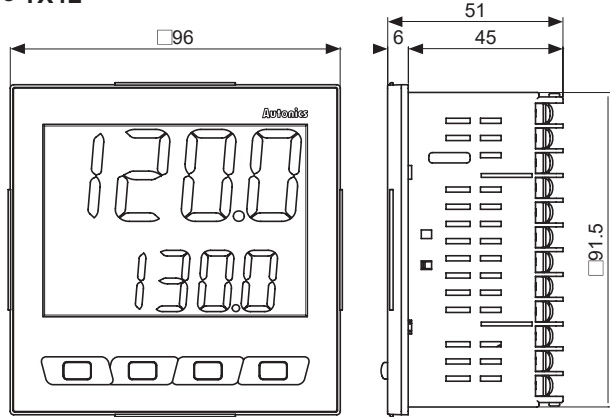

● Bracket

• TX4S Series

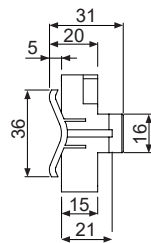
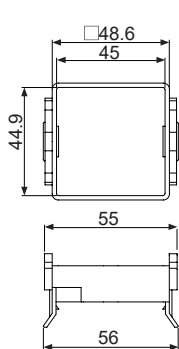

• TX4M/H/L Series

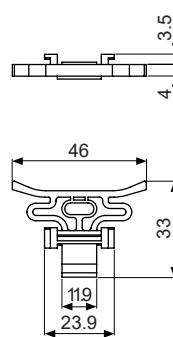

● Panel cut-out

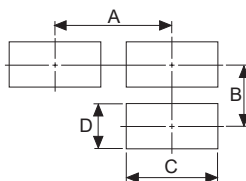

(unit: mm)

Model	Size			
	A	B	C	D
TX4S	Min. 65	Min. 65	45 ^{+0.6} ₀	45 ^{+0.6} ₀
TX4M	Min. 90	Min. 90	68 ^{+0.7} ₀	68 ^{+0.7} ₀
TX4H	Min. 115	Min. 65	45 ^{+0.6} ₀	92 ^{+0.8} ₀
TX4L	Min. 115	Min. 115	92 ^{+0.8} ₀	92 ^{+0.8} ₀

(A)	Photoelectric Sensors
(B)	Fiber Optic Sensors
(C)	Door/Area Sensors
(D)	Proximity Sensors
(E)	Pressure Sensors
(F)	Rotary Encoders
(G)	Connectors/ Connector Cables/ Sensor Distribution Boxes/Sockets
(H)	Temperature Controllers
(I)	SSRs / Power Controllers
(J)	Counters
(K)	Timers
(L)	Panel Meters
(M)	Tacho / Speed / Pulse Meters
(N)	Display Units
(O)	Sensor Controllers
(P)	Switching Mode Power Supplies
(Q)	Stepper Motors & Drivers & Controllers
(R)	Graphic/ Logic Panels
(S)	Field Network Devices
(T)	Software

TX Series

● Terminal cover (sold separately)

• RSA-COVER(48×48mm)

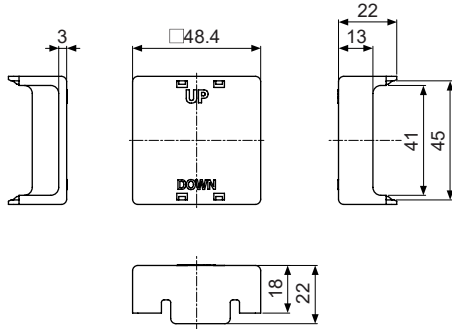

• RMA-COVER(72×72mm)

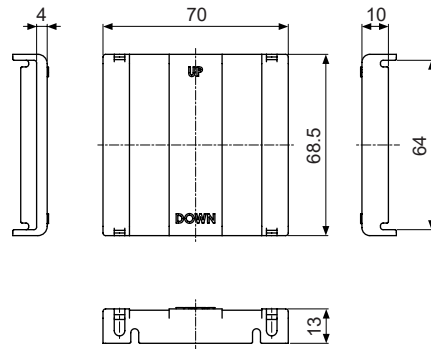

• RHA-COVER(48×96mm)

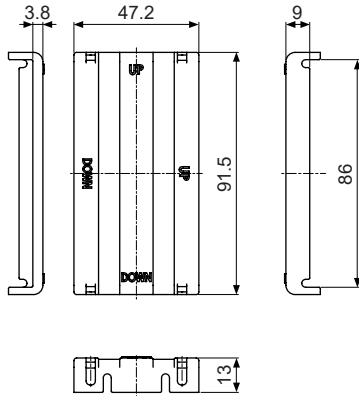

• RLA-COVER(96×96mm)

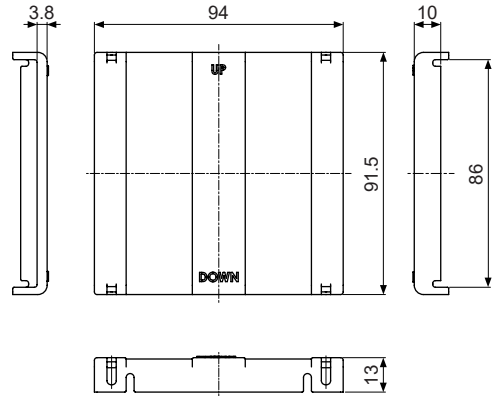

■ Product Mounting

● TX4S(48×48mm) series

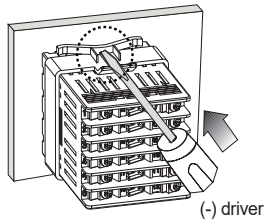

● Other series

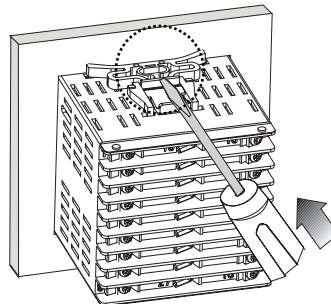

※Mount the unit on the panel. Push the bracket with tools to fix the unit as the figure.

LCD Display PID Control

■ Connections

※Shaded terminals are standard model.

※Use terminals of size specified below.

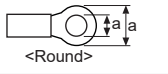
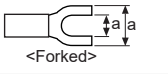
		
a	Min. 3.0mm	Min. 3.0mm
b	Max. 5.8mm	Max. 5.8mm

● TX4S series

OUT
SSR
12VDC±2V 20mA Max.
Current
DC0/4-20mA
Load 500ΩMax.
Relay
250VAC 3A 1a
30VDC 3A 1a
RESISTIVE LOAD

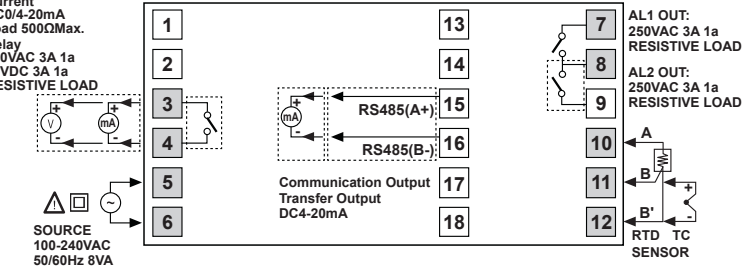

● TX4M series

OUT
Current
DC4-20mA
Load 500ΩMax.

OUT
SSR
13VDC±3V
20mA Max.

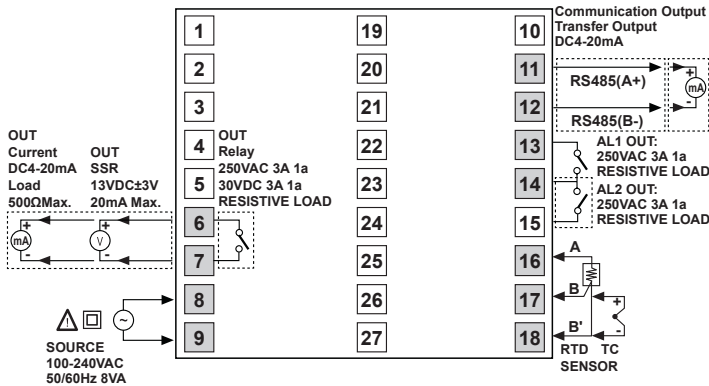

● TX4H, L series

OUT
Current
DC4-20mA
Load 500ΩMax.

OUT
Relay
250VAC 3A 1a
30VDC 3A 1a
RESISTIVE LOAD

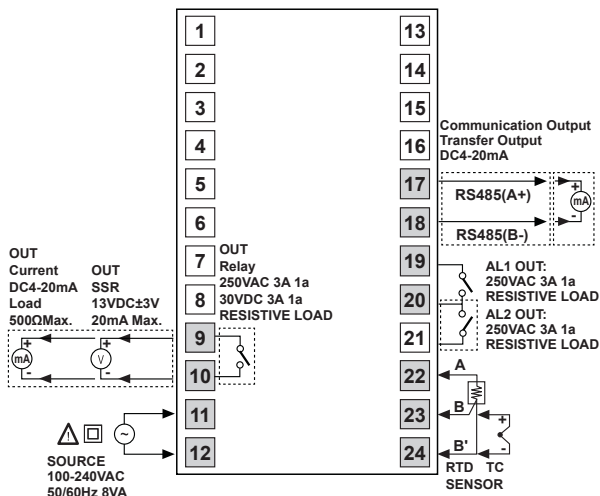

(A) Photoelectric Sensors

(B) Fiber Optic Sensors

(C) Door/Area Sensors

(D) Proximity Sensors

(E) Pressure Sensors

(F) Rotary Encoders

(G) Connectors/
Connector Cables/
Sensor Distribution
Boxes/Sockets

(H) Temperature Controllers

(I) SSRs / Power Controllers

(J) Counters

(K) Timers

(L) Panel Meters

(M) Tacho / Speed / Pulse Meters

(N) Display Units

(O) Sensor Controllers

(P) Switching Mode Power Supplies

(Q) Stepper Motors & Drivers & Controllers

(R) Graphic/ Logic Panels

(S) Field Network Devices

(T) Software

TX Series

■ Sold Separately

◎ Communication converter

- **SCM-WF48**
(Wi-Fi to RS485-USB wireless communication converter)
CE 



- **SCM-US48I**
(USB to RS485 converter)
CE 



- **SCM-38I**
(RS232C to RS485 converter)
CE 



- **SCM-US**
(USB to Serial converter)
CE 



- **EXT-US**
(converter cable)



◎ Display units (DS/DA-T Series)

- **DS/DA-T Series** CE
(RS485 communication input type display unit)



DS16-□T



DS22/DA22-□T



DS40/DA40-□T



DS60/DA60-□T

※Connect RS485 communication input type display unit (DS/DA-T Series) and RS485 communication output model of TX Series, the display unit displays present value of the device without PC/PLC.

■ Input Type and Range

Input type		Decimal point	Display	Input range(°C)	Input range(°F)
Thermocouple	K(CA)	1	K C A H	-50 to 1200	-58 to 2192
		0.1	K C A L	-50.0 to 999.9	-58.0 to 999.9
	J(IC)	1	J I C H	-30 to 800	-22 to 1472
		0.1	J I C L	-30.0 to 800.0	-22.0 to 999.9
	L(IC)	1	L I C H	-40 to 800	-40 to 1472
		0.1	L I C L	-40.0 to 800.0	-40.0 to 999.9
	T(CC)	1	T C C H	-50 to 400	-58 to 752
		0.1	T C C L	-50.0 to 400.0	-58.0 to 752.0
R(PR)	1	R P R	0 to 1700	32 to 3092	
	S(PR)	1	S P R	0 to 1700	32 to 3092
RTD	D Pt 100Ω	1	d P t . H	-100 to 400	-148 to 752
		0.1	d P t . L	-100.0 to 400.0	-148.0 to 752.0
	Cu50Ω	1	C U S H	-50 to 200	-58 to 392
		0.1	C U S L	-50.0 to 200.0	-58.0 to 392.0

LCD Display PID Control

Unit Description

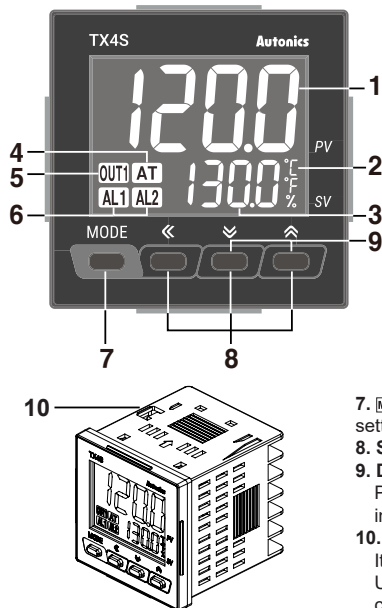

- 1. Measured value (PV) component:**
 RUN mode: Displays current measured value (PV).
 SETTING mode: Displays parameters.
- 2. Temperature unit (°C/°F) indicator:**
 Displays the set temperature unit as temperature unit [UNIT] of parameter group 2.
- 3. Setting value (SV) display component:**
 RUN mode: Displays setting value(SV).
 SETTING mode: Displays setting value of parameter.
- 4. Auto-tuning indicator:**
 Flashes during auto-tuning every 1 sec.
- 5. Control output (OUT1) indicator:**
 Turns ON while control output is ON.
 ※Turns ON when MV is over 3.0% at cycle/phase control of SSR drive output method.
- 6. Alarm output (AL1, AL2) indicator:**
 Turns ON when the corresponding alarm output turns ON.

- 7. [MODE] key:** Enters parameter group, returns to RUN mode, moves parameters, and saves the setting value.
- 8. Setting value adjustment key:** Enters SV setting mode and move digits.
- 9. Digital input key:**
 Press the [d] + [k] keys for 3 sec to execute the digital input key functions which is set at digital input key [d] - [k] of parameter group 2 (RUN/STOP, clear alarm output, auto-tuning).
- 10. PC loader port:**
 It is for serial communication to set parameter and monitoring by DAQMaster installed in PC. Use this for connection EXT-US (converter cable, sold separately) + SCM-US (USB to Serial converter, sold separately).

Parameter Group

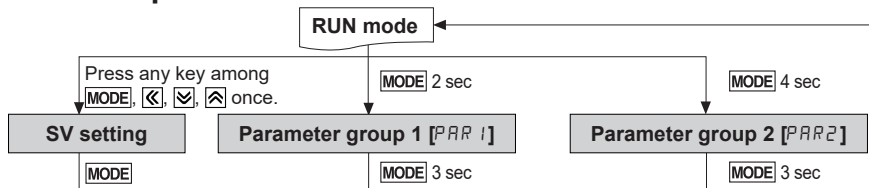

※Order of parameter setup **Parameter group 2** → **Parameter group 1** → **SV setting**

•All parameters are related one another. Set the parameters as above order.

※If there is no key input for 30 sec while setting SV or the parameters, the new settings are ignored, and the unit will return to RUN mode with previous settings.

※When returning to RUN mode by holding the [MODE] key for over 3 sec, press the [MODE] key within 1 sec to re-enter the first parameter of previous parameter group.

※Hold the [left] + [right] + [enter] keys for 5 sec in RUN mode, to enter re-set parameter menu. Select 'YES' and all parameters are reset as factory default.

• SV setting

※To change set temperature from 210°C to 250°C

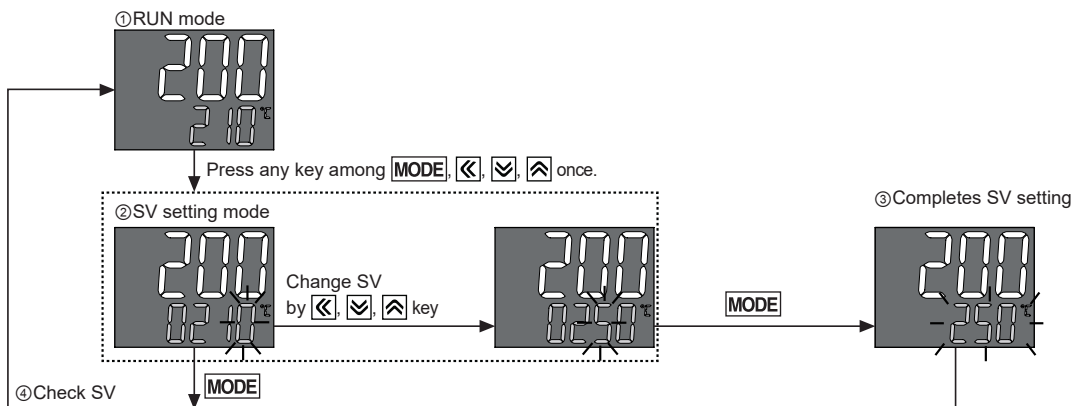

※If there is no key input for 3 sec while setting SV, the new setting is applied and the unit will return to RUN mode.

(A) Photoelectric Sensors

(B) Fiber Optic Sensors

(C) Door/Area Sensors

(D) Proximity Sensors

(E) Pressure Sensors

(F) Rotary Encoders

(G) Connectors/ Connector Cables/ Sensor Distribution Boxes/Sockets

(H) Temperature Controllers

(I) SSRs / Power Controllers

(J) Counters

(K) Timers

(L) Panel Meters

(M) Tacho / Speed / Pulse Meters

(N) Display Units

(O) Sensor Controllers

(P) Switching Mode Power Supplies

(Q) Stepper Motors & Drivers & Controllers

(R) Graphic/ Logic Panels

(S) Field Network Devices

(T) Software

TX Series

Parameter group 1

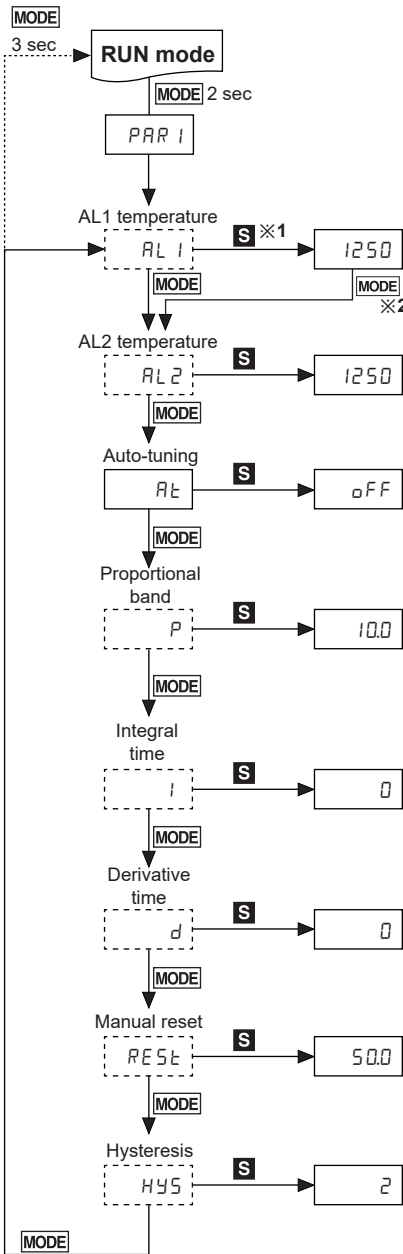

※1: **S**: Press any key among , , .

※2: Press the **MODE** key once after changing the setting value, to save the setting value and move to the next parameter

※Hold the **MODE** key for 3 sec to save the setting value and return to RUN mode after changing the setting value.

※:  Dotted parameters may not appear by model type or other parameter settings.

Setting range: Deviation alarm(- [F.S] to [F.S]).
Absolute value alarm(temperature range)

※Does not appear when AL1/AL2 alarm operation [AL - 1, AL - 2] of parameter group 2 is set as $RM0_1/5bR□/LbR□$.

※Only alarm output 2 models have [AL 2].

※When setting as oN , the unit starts auto-tuning. After completing, oFF is automatically set.

※During auto-tuning, the auto-tuning indicator flashes (every 1 sec).

Setting range: 0.1 to 999.9°C/°F

Setting range: 0 to 9999 sec
※Integral operation will be OFF when the setting value is '0'

Setting range: 0 to 9999 sec
※Derivative operation will be OFF when the setting value is '0'

Setting range: 0.0 to 100.0%
※Only appears in P, PD control.

Setting range: 1 to 100°C/°F (0.1 to 50.0°C/°F)

※Only appears when control method [$-Md$] of parameter group 2 is set as $oH oF$.

※Only appears when control method [$-Md$] of parameter group 2 is set as $Pt d$.

LCD Display PID Control

Parameter group 2

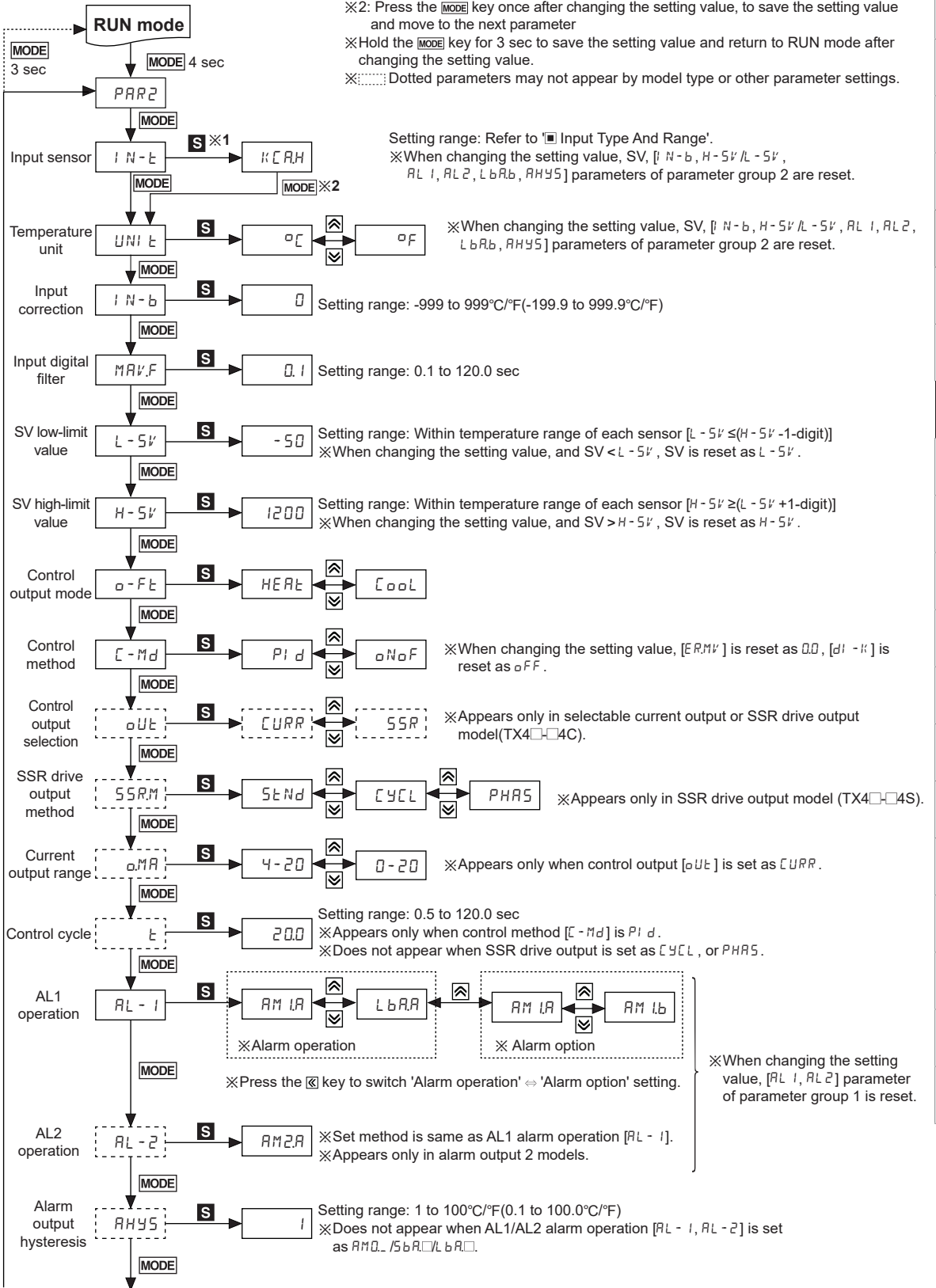

(A)	Photoelectric Sensors
(B)	Fiber Optic Sensors
(C)	Door/Area Sensors
(D)	Proximity Sensors
(E)	Pressure Sensors
(F)	Rotary Encoders
(G)	Connectors/ Connector Cables/ Sensor Distribution Boxes/Sockets
(H)	Temperature Controllers
(I)	SSRs / Power Controllers
(J)	Counters
(K)	Timers
(L)	Panel Meters
(M)	Tacho / Speed / Pulse Meters
(N)	Display Units
(O)	Sensor Controllers
(P)	Switching Mode Power Supplies
(Q)	Stepper Motors & Drivers & Controllers
(R)	Graphic/ Logic Panels
(S)	Field Network Devices
(T)	Software

TX Series

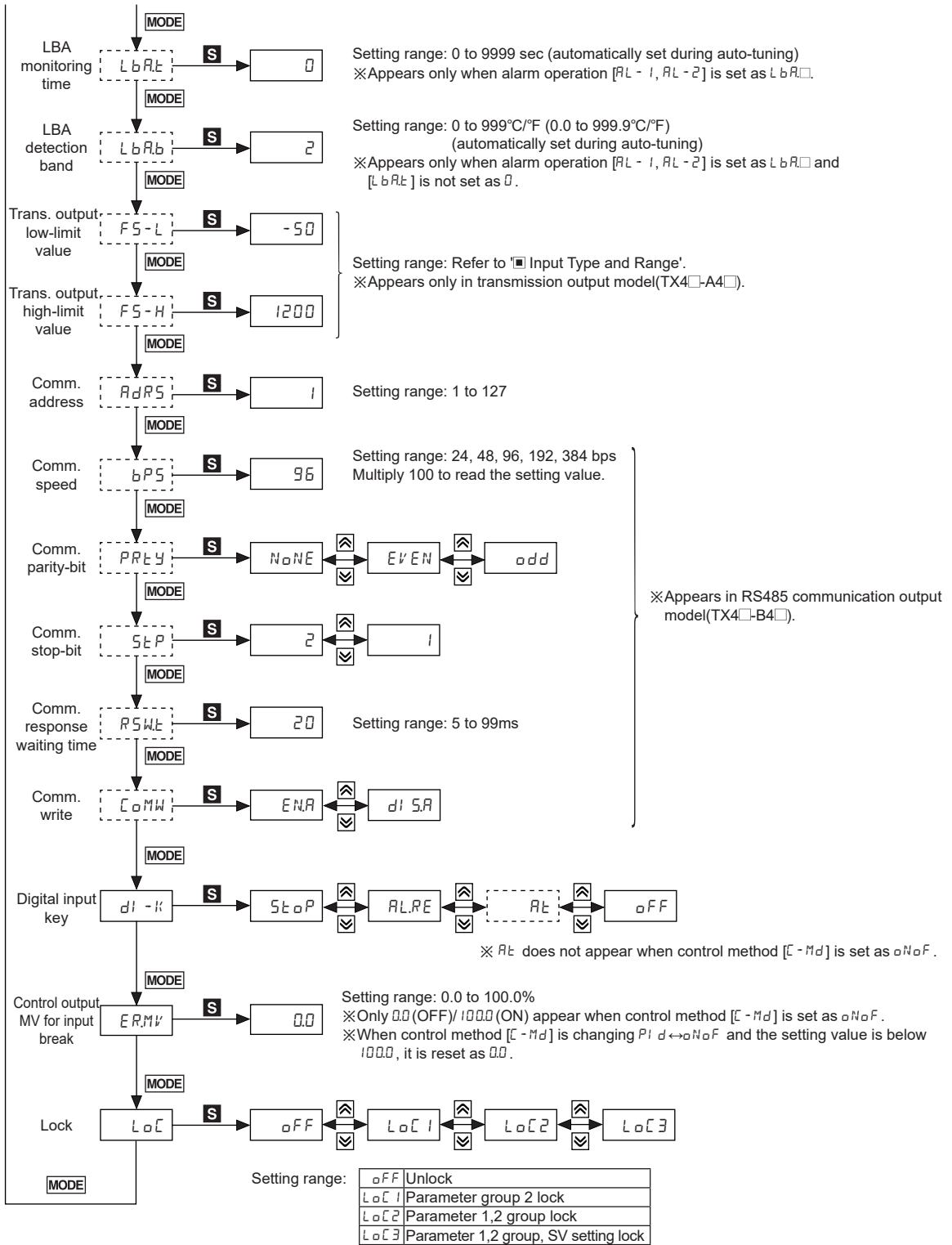

LCD Display PID Control

Alarm

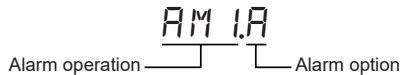

Set both alarm operation and alarm option by combining. Each alarm operates individually in two alarm output models. When the current temperature is out of alarm range, alarm clears automatically. If alarm option is alarm latch or alarm latch and standby sequence 1/2, press digital input key (☑+☒) 3 sec, digital input key [d1 - k] of parameter group 2 set as $R_{L,RE}$, or turn OFF the power and turn ON to clear alarm.

Alarm operation

Mode	Name	Alarm operation	Description
R_{M0}	-	-	No alarm output
R_{M1}	Deviation high-limit alarm	<p>High-limit deviation: Set as 10°C</p>	If deviation between PV and SV as high-limit is higher than set value of deviation temperature, the alarm output will be ON.
R_{M2}	Deviation low-limit alarm	<p>Low-limit deviation: Set as 10°C</p>	If deviation between PV and SV as low-limit is higher than set value of deviation temperature, the alarm output will be ON.
R_{M3}	Deviation high/low-limit alarm	<p>High, Low-limit deviation: Set as 10°C</p>	If deviation between PV and SV as high/low-limit is higher than set value of deviation temperature, the alarm output will be ON.
R_{M4}	Deviation high/low-limit reserve alarm	<p>High, Low-limit deviation: Set as 10°C</p>	If deviation between PV and SV as high/low-limit is higher than set value of deviation temperature, the alarm output will be OFF.
R_{M5}	Absolute value high limit alarm	<p>Alarm absolute-value: Set as 90°C</p>	If PV is higher than the absolute value, the output will be ON.
R_{M6}	Absolute value low limit alarm	<p>Alarm absolute-value: Set as 90°C</p>	If PV is lower than the absolute value, the output will be ON.
S_{bA}	Sensor break alarm	-	It will be ON when it detects sensor disconnection.
L_{bA}	Loop break alarm	-	It will be ON when it detects loop break.

※ H: Alarm output hysteresis [R_{HY5}]

Alarm option

Option	Name	Description
$R_{M□A}$	Standard alarm	If it is an alarm condition, alarm output is ON. If it is a clear alarm condition, alarm output is OFF.
$R_{M□b}$	Alarm latch	If it is an alarm condition, alarm output is ON and maintains ON status. (Alarm output HOLD)
$R_{M□C}$	Standby sequence 1	First alarm condition is ignored and from second alarm condition, standard alarm operates. When power is supplied and it is an alarm condition, this first alarm condition is ignored and from the second alarm condition, standard alarm operates.
$R_{M□d}$	Alarm latch and standby sequence 1	If it is an alarm condition, it operates both alarm latch and standby sequence. When power is supplied and it is an alarm condition, this first alarm condition is ignored and from the second alarm condition, alarm latch operates.
$R_{M□E}$	Standby sequence 2	First alarm condition is ignored and from second alarm condition, standard alarm operates. When re-applied standby sequence and if it is alarm condition, alarm output does not turn ON. After clearing alarm condition, standard alarm operates.
$R_{M□F}$	Alarm latch and standby sequence 2	Basic operation is same as alarm latch and standby sequence 1. It operates not only by power ON/OFF, but also alarm setting value, or alarm option changing. When re-applied standby sequence and if it is alarm condition, alarm output does not turn ON. After clearing alarm condition, alarm latch operates.

※ Condition of re-applied standby sequence for standby sequence 1, alarm latch and standby sequence 1: Power ON
 Condition of re-applied standby sequence for standby sequence 2, alarm latch and standby sequence 2: Power ON, changing set temperature, alarm temperature [R_{L 1}, R_{L 2}] or alarm operation [R_{L - 1}, R_{L - 2}], switching STOP mode to RUN mode.

(A) Photoelectric Sensors

(B) Fiber Optic Sensors

(C) Door/Area Sensors

(D) Proximity Sensors

(E) Pressure Sensors

(F) Rotary Encoders

(G) Connectors/ Connector Cables/ Sensor Distribution Boxes/Sockets

(H) Temperature Controllers

(I) SSRs / Power Controllers

(J) Counters

(K) Timers

(L) Panel Meters

(M) Tacho / Speed / Pulse Meters

(N) Display Units

(O) Sensor Controllers

(P) Switching Mode Power Supplies

(Q) Stepper Motors & Drivers & Controllers

(R) Graphic/ Logic Panels

(S) Field Network Devices

(T) Software

TX Series

• Sensor break alarm

The function that alarm output will be ON when sensor is not connected or when sensor's disconnection is detected during temperature controlling. You can check whether the sensor is connected with buzzer or other units using alarm output contact. It is selectable between standard alarm [5bRR] or alarm latch [5bRb].

• Loop break alarm(LBA)

It checks control loop and outputs alarm by temperature change of the subject. For heating control(cooling control), when control output MV is 100%(0% for cooling control) and PV is not increased over than LBA detection band [LbRb] during LBA monitoring time [LbRt], or when control output MV is 0%(100% for cooling control) and PV is not decreased below than LBA detection band [LbRb] during LBA monitoring time [LbRt], alarm output turns ON.

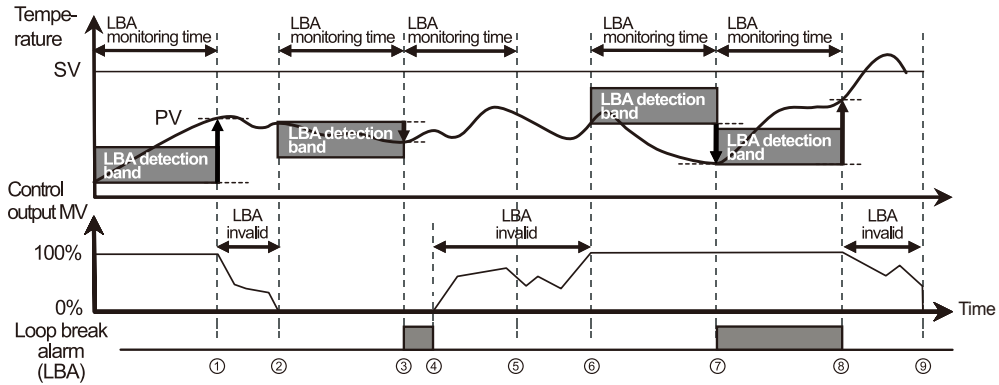

Start control to ①	When control output MV is 100%, PV is increased over than LBA detection band [LbRb] during LBA monitoring time [LbRt].
① to ②	The status of changing control output MV (LBA monitoring time is reset.)
② to ③	When control output MV is 0% and PV is not decreased below than LBA detection band [LbRb] during LBA monitoring time [LbRt], loop break alarm (LBA) turns ON after LBA monitoring time.
③ to ④	Control output MV is 0% and loop break alarm (LBA) turns and maintains ON.
④ to ⑥	The status of changing control output MV (LBA monitoring time is reset.)
⑥ to ⑦	When control output MV is 100% and PV is not increased over than LBA detection band [LbRb] during LBA monitoring time [LbRt], loop break alarm (LBA) turns ON after LBA monitoring time.
⑦ to ⑧	When control output MV is 100% and PV is increased over than LBA detection band [LbRb] during LBA monitoring time [LbRt], loop break alarm (LBA) turns OFF after LBA monitoring time.
⑧ to ⑨	The status of changing control output MV (LBA monitoring time is reset.)

※When executing auto-tuning, LBA detection band [LbRb] and LBA monitoring time are automatically set based on auto tuning value. When alarm operation mode [RL-1, RL-2] is set as loop break alarm(LBA) [LbR□], LBA detection band [LbRb] and LBA monitoring time [LbRt] parameter is displayed.

■ Functions

● Input correction [N-b]

Controller itself does not have errors but there may be error by external input temperature sensor. This function is for correcting this error. E.g.) If actual temperature is 80°C but controller displays 78°C, set input correction value [N-b] as '2' and controller displays 80°C. ※As the result of input correction, if current temperature value (PV) is over each temperature range of input sensor, it displays HHHH or LLLL.

● Input digital filter [MVF]

If current temperature (PV) is fluctuating repeatedly by rapid change of input signal, it reflects to MV and stable control is impossible. Therefore, digital filter function stabilizes current temperature value. For example, set input digital filter value as 0.4 sec, and it applies digital filter to input values during 0.4 sec and displays these values. Current temperature may be different by actual input value.

● SSR drive output method (SSRP function) [SSRM]

- SSRP function is selectable one of standard ON/OFF control, cycle control, phase control by utilizing standard SSR drive output.
- This function parameter appears only in SSR drive output model (TX4□□4S).
- Realizing high accuracy and cost effective temperature control with both current output (4-20mA) and linear output(cycle control and phase control)
- Select one of standard ON/OFF control [5tNd], cycle control [CYCL], phase control [PHAS] at SSRM parameter of parameter group 2. For cycle control, connect a zero cross turn-on SSR or random turn-on SSR. For phase control, connect random turn-on SSR.

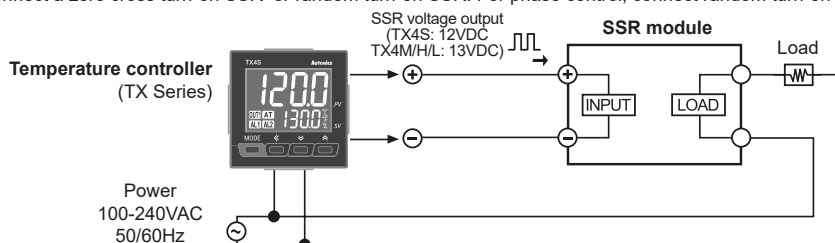

※When selecting cycle or phase control mode, **the power supply for a load and a temperature controller must be the same.**

※Control cycle [t] is able to set only when control method [C-Md] of parameter group 2 is set as *Pid* and SSR drive output method [SSRM] is set as 5tNd.

※In case of selectable current output or SSR drive output model(TX4□□4C), this parameter does not appear. Standard ON/OFF control by SSR is only available.

1) Standard ON/OFF control [5tNd]

Controls ON (100% output)/OFF (0% output) as same as standard relay output.

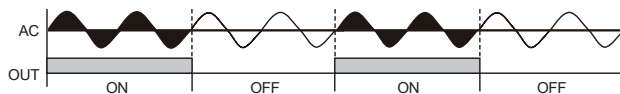

2) Cycle control [CYCL]

Controls the load by repeating output ON / OFF according to the rate of output within setting cycle based on certain period (50-cycle).

Control accuracy is almost the same with phase control's.

This control has improved ON/OFF noise than phase control's due to zero cross type which turns ON/OFF at zero point of AC.

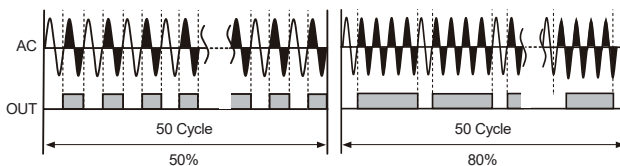

3) Phase control [PHAS]

Controls the load by controlling the phase within AC half cycle. Serial control is available.

Must use random turn-on SSR for this mode.

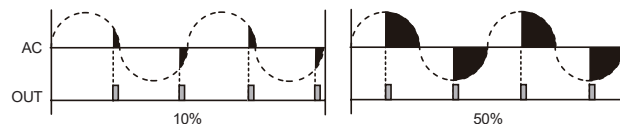

● Current output range [oMR]

In case of selectable current output or SSR drive output model(TX4S□□4C), when control output [OUT] parameter group 2 is set as [CURR], you can select high/low-limit range, 4-20mA [4-20] or 0-20mA [0-20] of current output.

● Hysteresis [HYS]

Set interval between ON and OFF of control output for ON/OFF control.

• If hysteresis is too narrow, hunting(oscillation, chattering) could occur due to external noise.

• In case of ON / OFF control mode, even if PV reaches stable status, there still occurs hunting. It could be due to hysteresis [HYS] setting value, load's response characteristics or sensor's location. In order to reduce hunting to a minimum, it is required to take into following factors consideration when designing temp. controlling; proper Hysteresis [HYS], heater's capacity, thermal characteristics, sensor's response and location.

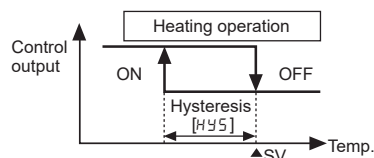

(A) Photoelectric Sensors

(B) Fiber Optic Sensors

(C) Door/Area Sensors

(D) Proximity Sensors

(E) Pressure Sensors

(F) Rotary Encoders

(G) Connectors/ Connector Cables/ Sensor Distribution Boxes/Sockets

(H) Temperature Controllers

(I) SSRs / Power Controllers

(J) Counters

(K) Timers

(L) Panel Meters

(M) Tacho / Speed / Pulse Meters

(N) Display Units

(O) Sensor Controllers

(P) Switching Mode Power Supplies

(Q) Stepper Motors & Drivers & Controllers

(R) Graphic/ Logic Panels

(S) Field Network Devices

(T) Software

TX Series

• Manual reset [RESE]

When selecting P/PD control mode, certain temperature difference exists even after PV reaches stable status because heater's rising and falling time is inconsistent due to thermal characteristics of controlled objects, such as heat capacity, heater capacity. This temperature difference is called offset and manual reset [RESE] function is to set/correct offset.

When PV and SV are equal, reset value is 50.0%. After control is stable, PV is lower than SV, reset value is over 50.0% or PV is higher than SV, reset value is below 50.0%.

• Manual reset [RESE] by control result

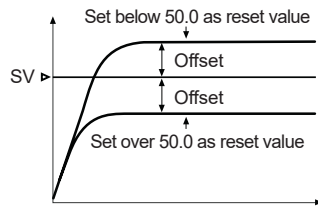

• Digital input key (☑ + ⏏ 3 sec) [dI-k]

Parameter	Operation
OFF	oFF It does not use digital input key function.
RUN/STOP	StoP Pauses control output. Auxiliary output (except loop break alarm, sensor break alarm) except Control output operates as setting. Hold the digital input keys for 3 sec to restart.
Clear alarm	ALRE Clears alarm output by force. (only when alarm option is alarm latch, or alarm latch and standby sequence 1/2.) This function is applied when present value is out of alarm operation range but alarm output is ON. Alarm operates normally right after clearing alarm.
Auto-tuning	RE Starts/Stops auto-tuning. This function is same as auto-tuning [RE] of parameter group 1. (You can start auto-tuning [RE] of parameter group 1 and stop it by digital input key.) ※ This parameter RE appears only when control method [C-Md] parameter group 2 is set as PID. When control method [C-Md] parameter group 2 is set as oNF, this parameter is changed as oFF.

• Control output MV for input break [ERMV]

When input sensor is break, set control output MV.

When control method [C-Md] of parameter group 2 is set as oNF, set control output MV as 0.0 (OFF) or 100.0 (ON). When control method [C-Md] is set as PID, setting range for control output MV is 0.0 to 100.0.

■ Communication Setting

It is for parameter setting and monitoring via external devices (PC, PLC, etc.).

Applicable for models with RS485 communication output through option output (TX4□-B4□).

Please refer to '■Ordering Information'.

• Interface

Comm. protocol	Modbus RTU	Comm. speed	4800, 9600 (default), 19200, 38400, 115200 bps
Connection type	RS485	Response waiting time	5 to 99ms (default: 20ms)
Application standard	EIA RS485 Compliance with	Start bit	1bit (fixed)
Max. connection	32 units (address: 01 to 127)	Data bit	8bit (fixed)
Synchronous method	Asynchronous	Parity bit	None (default), Odd, Even
Comm. method	Two-wire half duplex	Stop bit	1bit, 2bit (default)
Comm. effective range	Max. 800m		

• Application of system organization

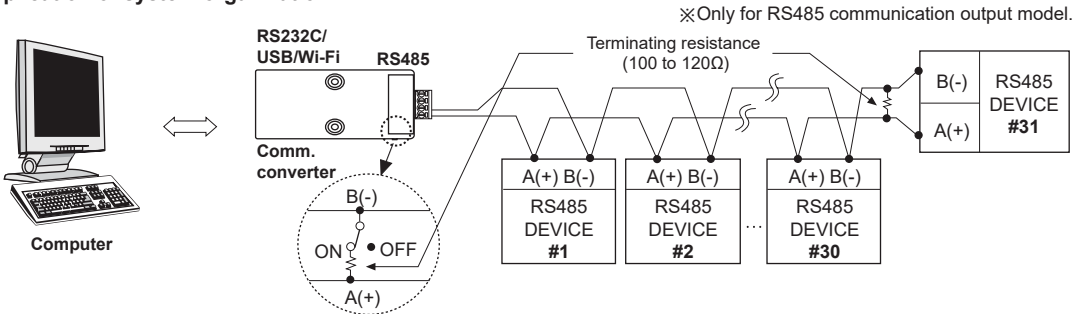

※It is recommended to use Autonics communication converter; SCM-WF48 (Wi-Fi to RS485-USB wireless communication converter, sold separately), SCM-US48I (USB to RS485 converter, sold separately), SCM-38I (RS232C to RS485 converter, sold separately).

Please use twisted pair wire, which is suitable for RS485 communication, for SCM-WF48, SCM-US48I and SCM-38I.

LCD Display PID Control

■ Factory Default

● SV setting

Parameter	Factory default
—	0

● Parameter group 1

Parameter	Factory default
RL1	1250
RL2	
RL	OFF
P	10.0
I	0
d	
RESET	50.0
HYS	2

● Parameter group 2

Parameter	Factory default	Parameter	Factory default
IN-L	KCRH	HHYS	1
UNI-L	0C	LbAL	0
IN-b	0	LbAb	2
MAVF	0.1	FS-L	-50
L-SV	-50	FS-H	1200
H-SV	1200	AdRS	1
o-FL	HEAL	bPS	96
C-Md	PI d	PRtY	NONE
oUt	CURR	StP	2
SSRM	StNd	RSWt	20
oMR	4-20	CoMH	ENR
t	200(Relay)	di-k	StoP
	20(SSR diode)	ERMV	0.0
RL-1	AM1A	LoC	OFF
RL-2	AM2A		

■ Error

Display	Description	Troubleshooting
oPEN	Flashes when input sensor is disconnected or sensor is not connected.	Check input sensor status.
HHHH	Flashes when measured value is higher than input range.	When input is within the rated input range, this display disappears.
LLLL	Flashes when measured value is lower than input range.	

■ Proper Usage

◎ Cautions during use

- Follow instructions in 'Cautions during Use'. Otherwise, It may cause unexpected accidents.
- Check the polarity of the terminals before wiring the temperature sensor.
For RTD temperature sensor, wire it as 3-wire type, using cables in same thickness and length.
For thermocouple (CT) temperature sensor, use the designated compensation wire for extending wire.
- Keep away from high voltage lines or power lines to prevent inductive noise.
In case installing power line and input signal line closely, use line filter or varistor at power line and shielded wire at input signal line.
Do not use near the equipment which generates strong magnetic force or high frequency noise.
- Do not apply excessive power when connecting or disconnecting the connectors of the product.
- Install a power switch or circuit breaker in the easily accessible place for supplying or disconnecting the power.
- Do not use the unit for other purpose (e.g. voltmeter, ammeter), but temperature controller.
- When changing the input sensor, turn off the power first before changing.
After changing the input sensor, modify the value of the corresponding parameter.
- Do not overlapping communication line and power line.
Use twisted pair wire for communication line and connect ferrite bead at each end of line to reduce the effect of external noise.
- Make a required space around the unit for radiation of heat.
For accurate temperature measurement, warm up the unit over 20 min after turning on the power.
- Make sure that power supply voltage reaches to the rated voltage within 2 sec after supplying power.
- Do not wire to terminals which are not used.
- This unit may be used in the following environments.
 - ①Indoors (in the environment condition rated in 'Specifications')
 - ②Altitude max. 2,000m
 - ③Pollution degree 2
 - ④Installation category II

(A) Photoelectric Sensors

(B) Fiber Optic Sensors

(C) Door/Area Sensors

(D) Proximity Sensors

(E) Pressure Sensors

(F) Rotary Encoders

(G) Connectors/ Connector Cables/ Sensor Distribution Boxes/Sockets

(H) Temperature Controllers

(I) SSRs / Power Controllers

(J) Counters

(K) Timers

(L) Panel Meters

(M) Tacho / Speed / Pulse Meters

(N) Display Units

(O) Sensor Controllers

(P) Switching Mode Power Supplies

(Q) Stepper Motors & Drivers & Controllers

(R) Graphic/ Logic Panels

(S) Field Network Devices

(T) Software