



Clock Oscillator SMD-version

+3,3V

model	KXO-V97T
frequency	66,0 MHz
frequency stability at -40° ~ +85°C	± 100 ppm
operating temperature	-40° ~ +85°C
storage temperature	-40° ~ +85°C
symmetry	50% ± 10% at ½ V _{DD} level
rise & fall time max.	5 ns
"0" level max.	+ 0,4V
"1" level min.	V _{DD} -0,5V
input voltage V _{DD}	+ 3,3V ± 10%
input current	9,0 mA typ., 16,0 mA max.
output load	30 pF
start up time max.	10 ms
tristate function	yes
disable delay time	100 ns max.
enable delay time	4 ms max.
random jitter	7ps max.
peak to peak jitter	40ps max.
contents of reel	1000 pcs.
part no.	12.94408

Dimensions (mm):

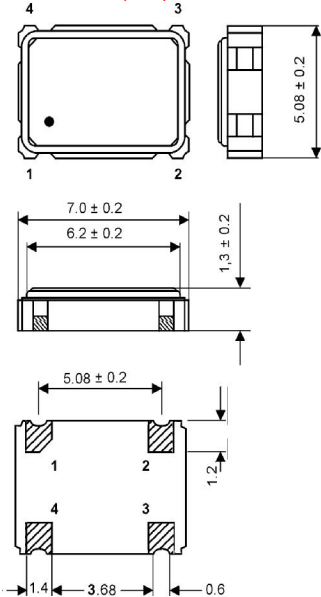

Output waveform:

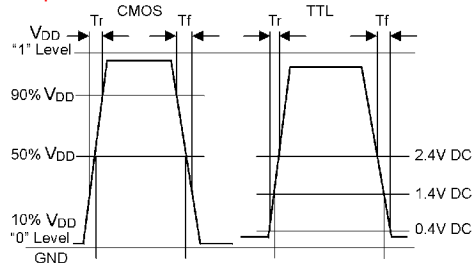

Reflow soldering condition:

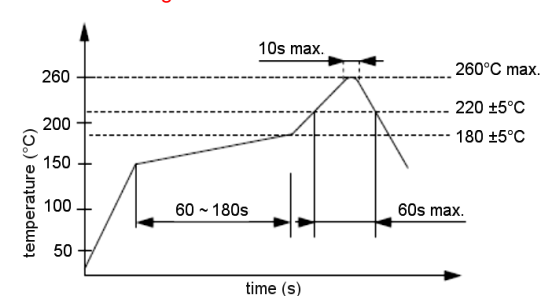

Test circuit:

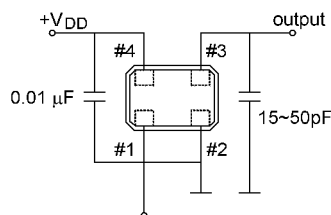

Tape specifications:

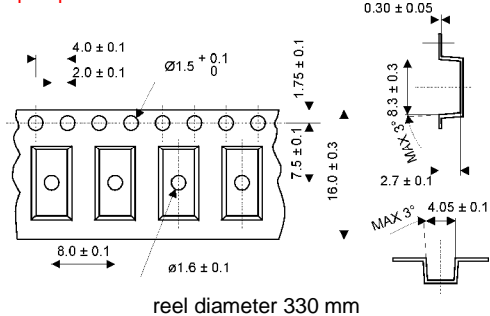

Suggested soldering pad:

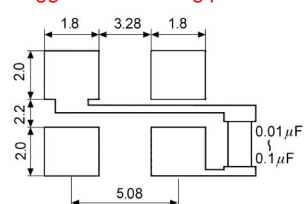

PIN	CONNECTION
1	"L" (OV) "H" or OPEN
2	GND
3	OUTPUT
4	V _{DD}

Z: high impedance