

### INTRODUCTION:

Adam Tech IEC & Mini IEC Series AC Inlets and Outlets are primary power receptacles designed, manufactured, tested and approved to UL, CSA, VDE and other applicable international specifications including IEC-60320 and CEE-22. Adam Tech offers a wide variety of body styles, shapes and orientations to accommodate most class I & II applications with two or three blade contacts in both IEC and Mini-IEC configurations. Mounting choices include screw holes and snap-in versions and four termination styles. Options of ganged ports or receptacle with integral fuse holder are also available.

### FEATURES:

IEC & Mini-IEC types  
IEC-60320, CEE-22 Compliant  
UL, CSA and VDE approved  
Multitude of Body Styles  
Choice of terminations  
Option of Integral Fuse Holder

### MATING CONNECTORS:

Adam Tech PC series power cords and all standard international IEC 60320 power supply cords.

### SPECIFICATIONS:

#### Material:

Insulator: Polycarbonate or Nylon 66, glass filled, rated UL94V-0  
Insulator Color: Black  
Contacts: Phosphor Bronze or Brass

#### Plating:

Nickel over copper underplate. (Solder terminals: Tin over copper underplate)

#### Electrical:

Operating Voltage: 250V AC  
Current Rating: IEC - UL & CSA: 15 Amps Max,  
VDE: 10 Amps Max.  
Mini IEC - UL, CSA & VDE 2.5 Amps Max.

Insulation Resistance: 100 MΩ Min. @ 500V DC  
Dielectric Withstanding Voltage: 2000V AC for 1 Minute

#### Temperature Rating:

Operation Temperature: -25°C ~ +70°C

### PACKAGING:

Anti-ESD plastic trays

### SAFETY AGENCY APPROVALS:

UL Recognized File Nos. E224049, E224050, E224051, E224052  
CSA Certified File No. 226373



DB12



### ORDERING INFORMATION

IEC	A	1	150
<b>SERIES INDICATOR</b> IEC = International inlet/outlet	<b>TERMINALS</b>		<b>PANEL THICKNESS</b> (for body styles C, D & J only) <b>Blank</b> = Universal Snap
		1 = .187" Quick-connect terminals	<b>080</b> = 0.8mm Panel
		2 = .250" Quick-connect terminals	<b>120</b> = 1.2mm Panel
		3 = Solder terminals .157" [4.0mm]	<b>150</b> = 1.5mm Panel
		4 = Right Angle PCB mount	<b>200</b> = 2.0mm Panel
		5 = Solder Terminals .098" [2.5mm]	<b>300</b> = 3.0mm Panel

### BODY STYLE

- A = Male Inlet, Screw-on panel mount
- B = Female Outlet, Screw-on panel mount
- C = Male Inlet, Snap-in panel mount
- D = Female Outlet, Snap-in panel mount
- E = Male Inlet, Right Angle PC board mount with mounting flange (Specify EW, EX, EY or EZ)
- F = Male Inlet, Screw on panel mount with 5 x 20mm fuse holder
- G = Male Inlet, Snap-in panel mount with 5 x 20mm fuse holder
- HS = Inlet/Outlet, snap-in panel mount
- HR = Inlet/outlet, snap-in panel mount, right angle PCB mount
- J = Male inlet, right angle PCB & tail with snap-in panel mounting
- NA = Mini-IEC right angle, snap-in
- NB = Mini-IEC right angle, slide-in
- NB-A = Mini-IEC right angle, slide-in with pegs
- NC = Mini-IEC right angle, with flush flange
- NC-A = Mini-IEC right angle, with extended face
- ND = Mini-IEC right angle, with enclosed body
- NF = Mini-IEC right angle, polarized with flange
- NH = Mini-IEC right angle, with ground pin
- NH-A = Mini-IEC right angle, flange mount with ground pin
- GS = Fused inlet with switch snap in panel mount
- FS = Fused inlet with switch screw on panel mount

### OPTIONS:

- K = Keyed for 120° C (Body Styles A, C, E & J)
- M = Female outlet, 20 AMP, Flanged
- N = Male inlet, 20 AMP, Snap-In

**IEC-A  
SCREW ON  
PANEL MOUNT**

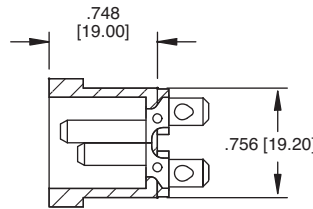
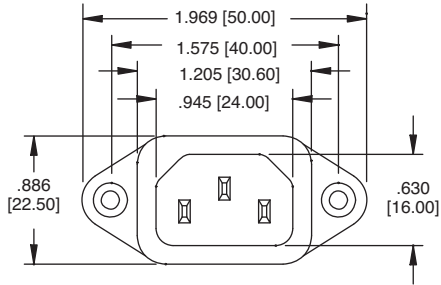

**IEC-A-1**

1.075 [27.30] Front Mounting  
1.212 [30.80] Rear Mounting

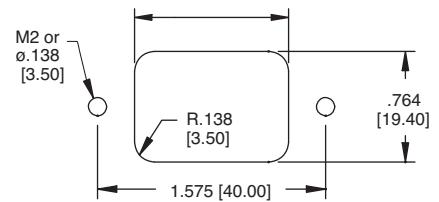
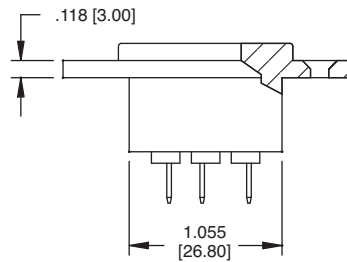

TERMINAL OPTIONS			
1	2	3	5
.187 Q.C.	.250 Q.C.	.157 Solder	.098 Solder

**IEC-A  
SCREW ON PANEL  
RIGHT ANGLE PCB MOUNT**

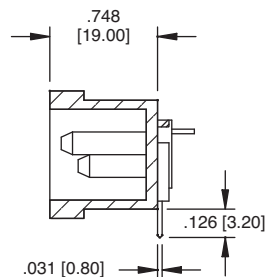
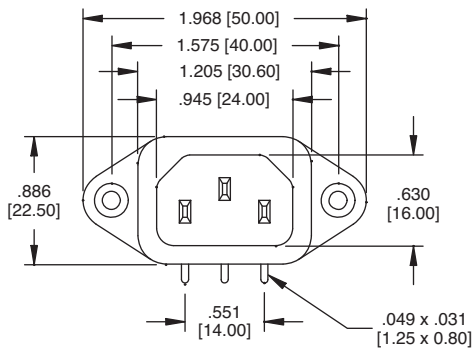

**IEC-A-4**

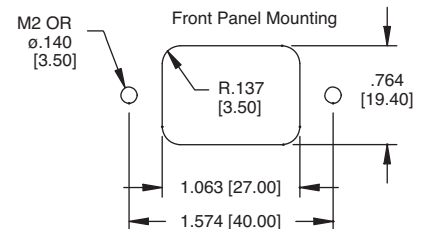
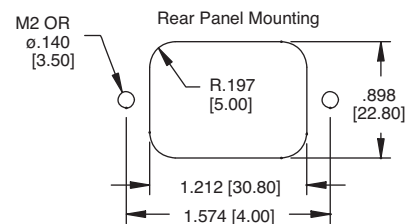
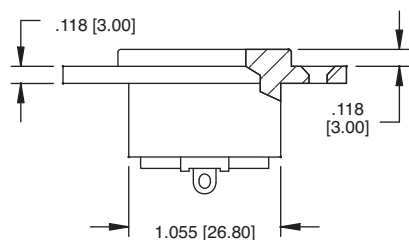

#### IEC-C UNIVERSAL PANEL SNAP

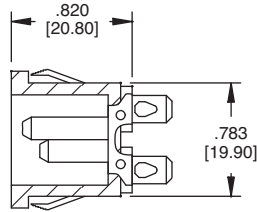
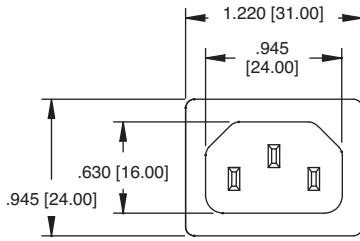

IEC-C-1

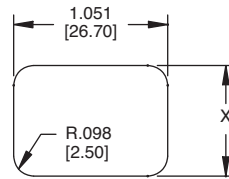
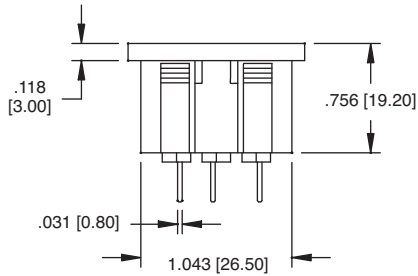

**Recommended Panel  
Thickness: 0.8mm - 3.0mm**

PANEL THICKNESS	DIM X
.031-.039 [0.8-1.0]	.780 [19.8]
.039-.059 [1.0-1.5]	.784 [19.9]
.079-.119 [2.0-3.0]	.788 [20.0]

TERMINAL OPTIONS			
1	2	3	5
.187 Q.C.	.250 Q.C.	.157 Solder	.098 Solder

#### IEC-C DEDICATED PANEL SNAP

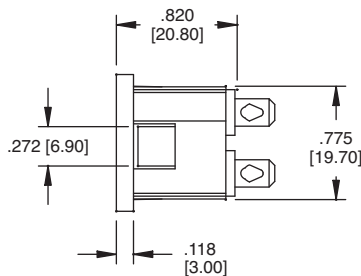
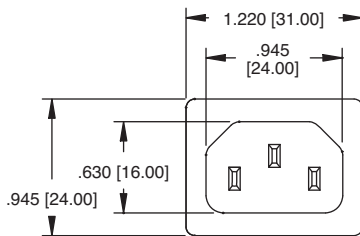

IEC-C-1-150

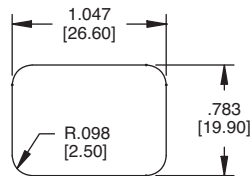
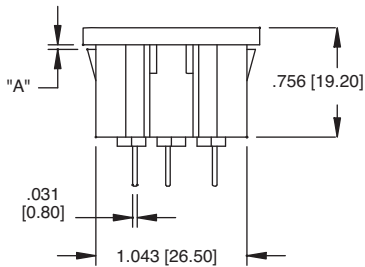

**Recommended  
Panel Cut-Out**

PANEL THICKNESS	PART NUMBER	DIM "A"
0.8mm	IEC-C-X-080	.031 [0.80]
1.5mm	IEC-C-X-150	.059 [1.50]
3.0mm	IEC-C-X-300	.118 [3.00]
4.0mm	IEC-C-X-400	.157 [4.00]

Replace X with terminal option below

TERMINAL OPTIONS			
1	2	3	5
.187 Q.C.	.250 Q.C.	.157 Solder	.098 Solder

**IEC-J  
UNIVERSAL PANEL SNAP  
RIGHT ANGLE PCB MOUNT**

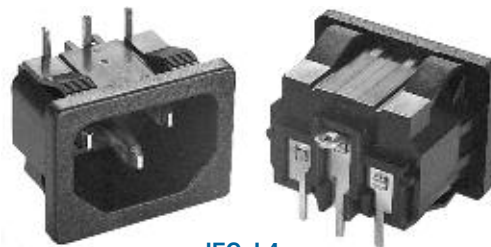
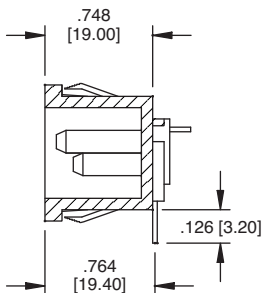
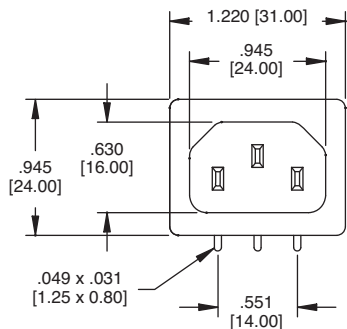

**IEC-J-4**

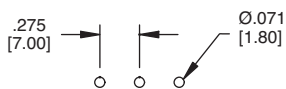
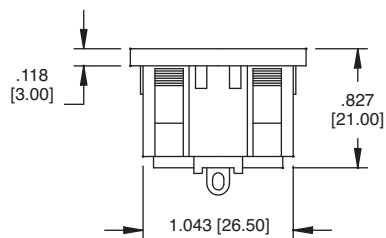

**Recommended PCB  
Layout**

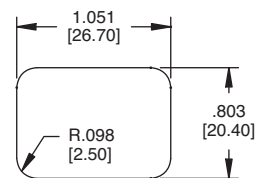

**Recommended Panel  
Thickness: 0.80mm - 3.0mm**

**IEC-J  
DEDICATED PANEL SNAP  
RIGHT ANGLE PCB MOUNT**

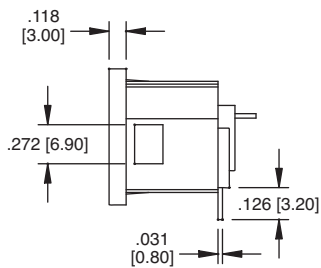
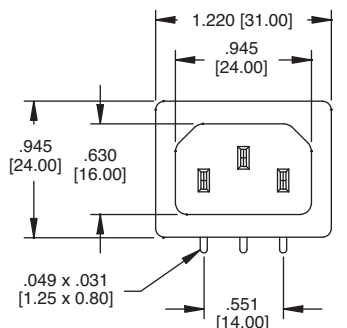

**IEC-J-4-150**

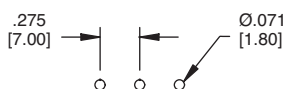
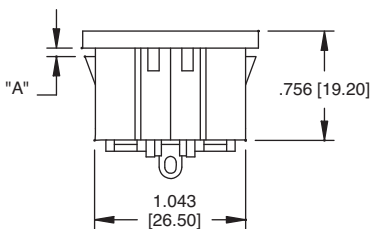

**Recommended PCB  
Layout**

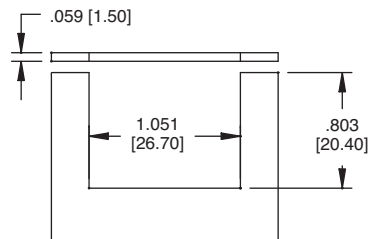

**Recommended Panel Cut-Out**

PANEL THICKNESS	PART NUMBER	DIM "A"
0.8mm	IEC-J-4-120	.047 [1.20]
1.5mm	IEC-J-4-150	.059 [1.50]
3.0mm	IEC-J-4-200	.079 [2.00]
4.0mm	IEC-J-4-300	.118 [3.00]

### IEC-E FLANGED RIGHT ANGLE PCB MOUNT

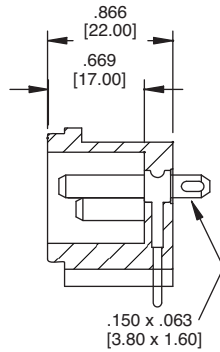
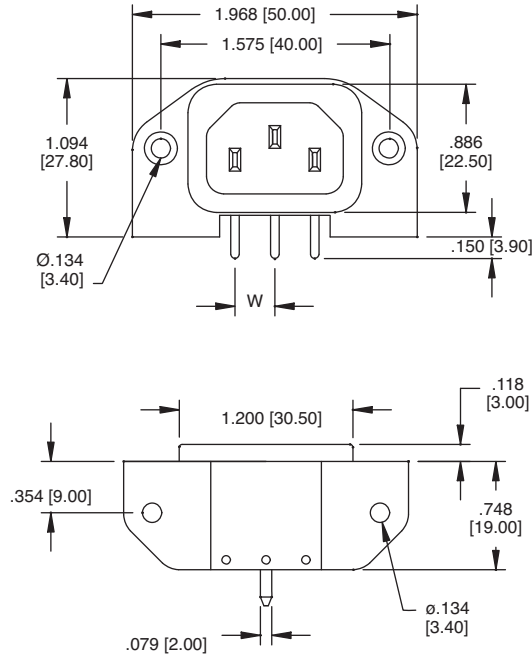

IEC-EW-4

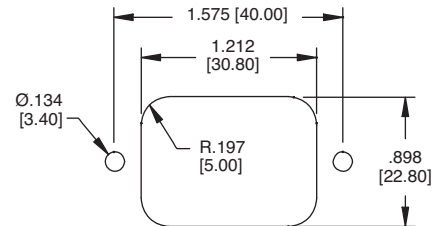

Recommended Panel Cut-Out

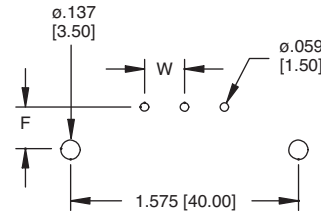

Recommended PCB Layout

DIMENSIONAL		
PART NO.	F	W
IEC-EW	.287 [7.30]	.276 [7.00]
IEC-EX	.287 [7.30]	.358 [9.10]
IEC-EY	.382 [9.70]	.276 [7.00]
IEC-EZ	.382 [9.70]	.358 [9.10]

### IEC-B FLANGED SCREW ON PANEL MOUNT

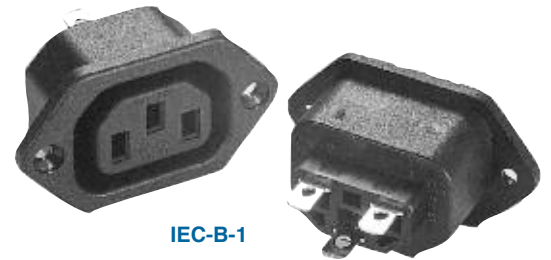
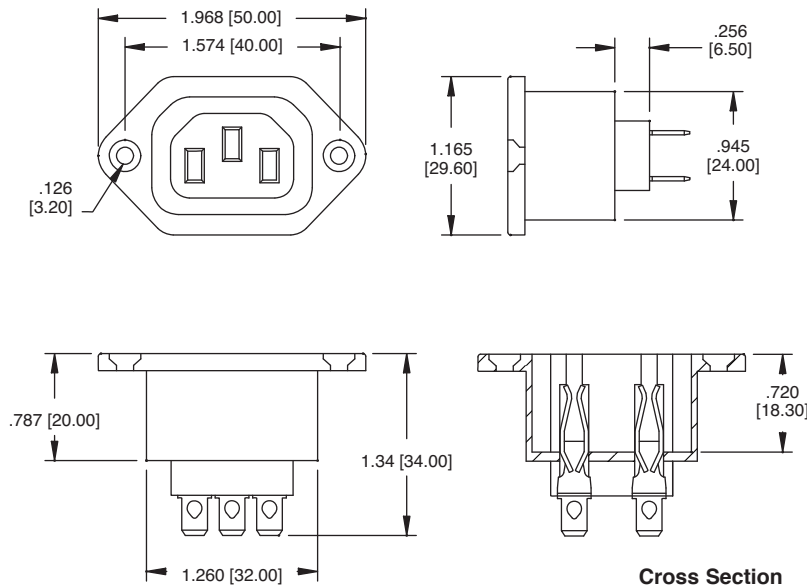

IEC-B-1

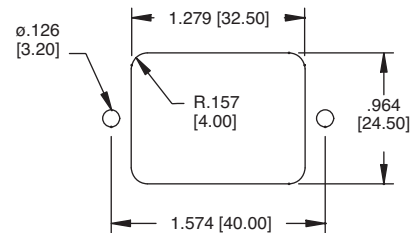

Recommended Panel Cut-Out

TERMINAL OPTIONS		
1	2	3
.187 Q.C.	.250 Q.C.	.157 Solder

#### IEC-D UNIVERSAL PANEL SNAP

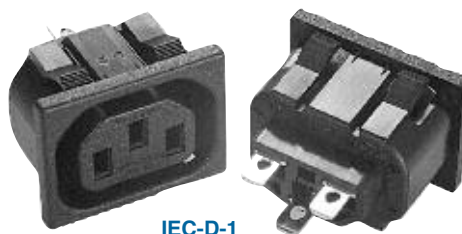
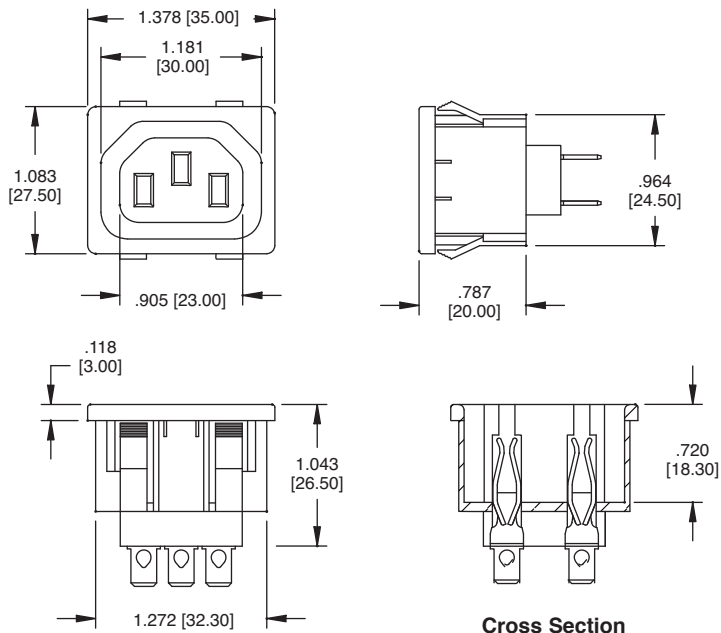

IEC-D-1

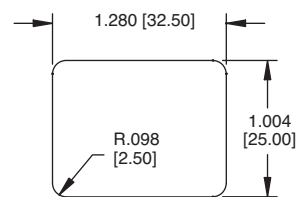

Recommended Panel Thickness:  
0.8mm - 3.0mm

TERMINAL OPTIONS		
1	2	3
.187 Q.C.	.250 Q.C.	.157 Solder

#### IEC-F FUSED, SCREW ON PANEL MOUNT

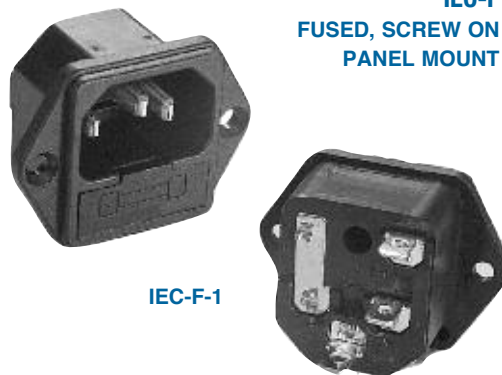
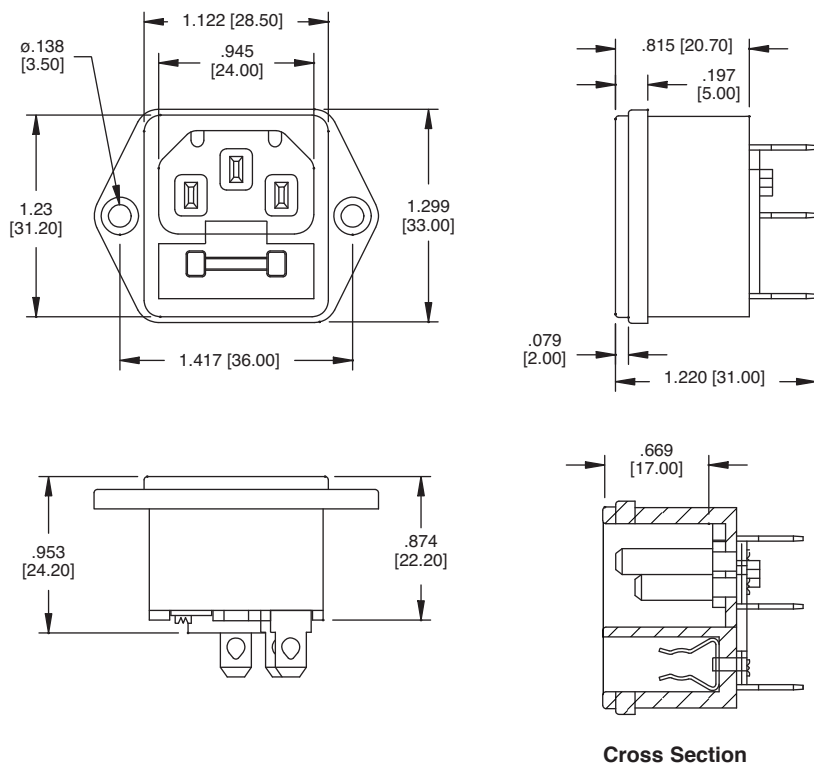

IEC-F-1

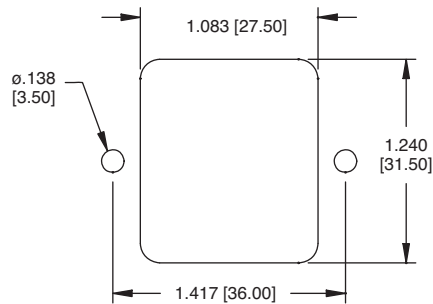

Recommended Panel Cut-Out

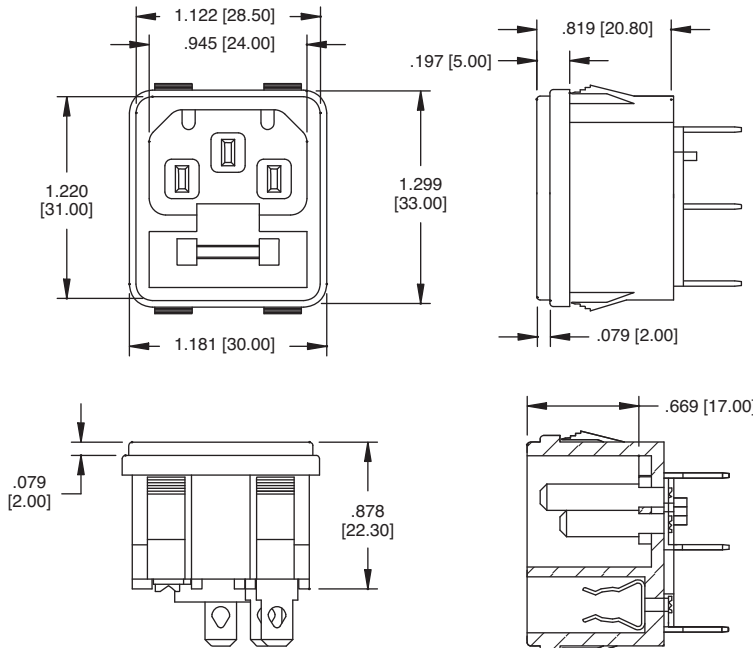

PANEL THICKNESS	DIM X
.031-.071 [0.8-1.8]	1.240 [31.50]
.075-.126 [1.9-3.2]	1.248 [31.70]

Cross Section

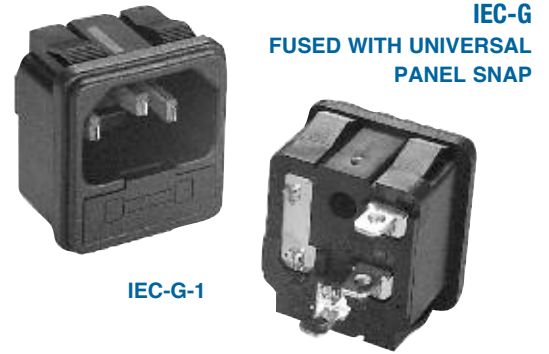

IEC-G-1

IEC-G  
FUSED WITH UNIVERSAL  
PANEL SNAP

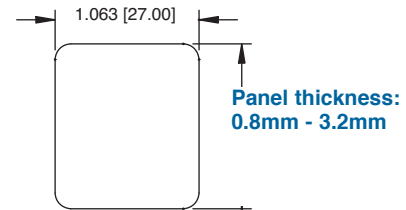

Panel thickness:  
0.8mm - 3.2mm

TERMINAL OPTIONS		
1	2	3
.187 Q.C.	.250 Q.C.	.157 Solder

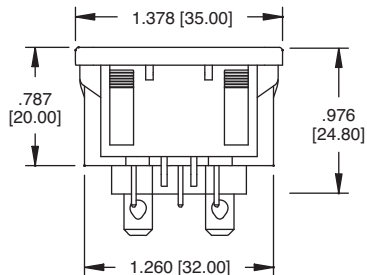
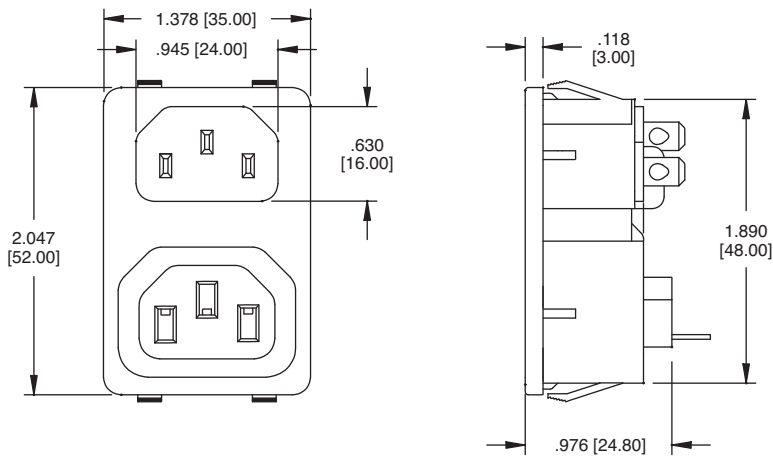

Recommended Panel Cut-Out

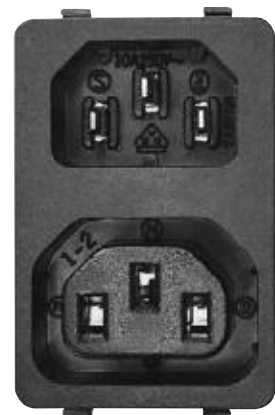

IEC-HS-1

IEC-HS  
FUSED INLET & OUTLET  
WITH UNIVERSAL  
PANEL SNAP



#### IEC-GS-1

FUSED INLET WITH SWITCH,  
SNAP IN PANEL MOUNT

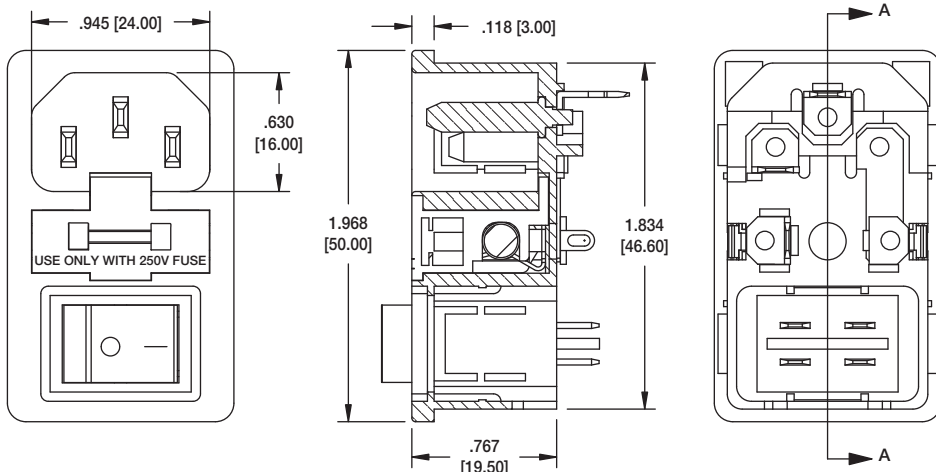

PART NUMBER	DIM "A"
IEC-GS-1-100	.039 [1.00]
IEC-GS-1-150	.059 [1.50]
IEC-GS-1-200	.079 [2.00]



IEC-GS-1-100

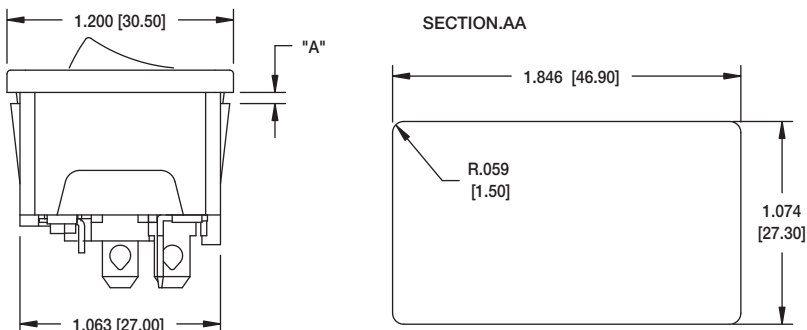

Recommended Panel Cut-Out

#### IEC-FS-1

FUSED INLET WITH SWITCH,  
SWITCH, SCREW ON  
PANEL MOUNT

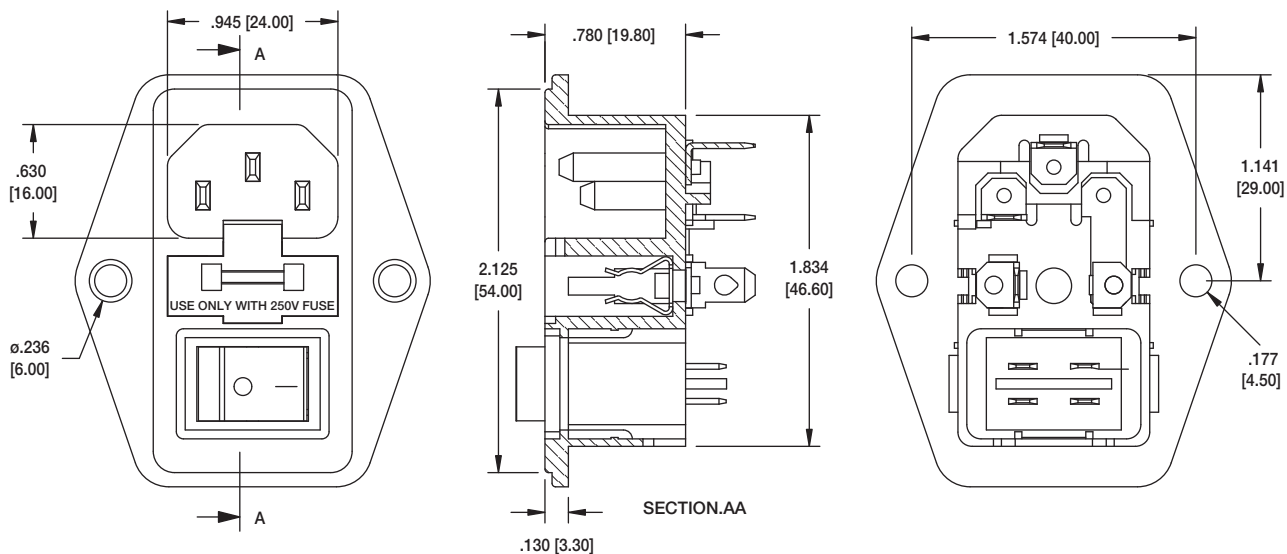



**IEC-D-S**  
**STACKED OUTLETS WITH**  
**DEDICATED PANEL SNAPS**

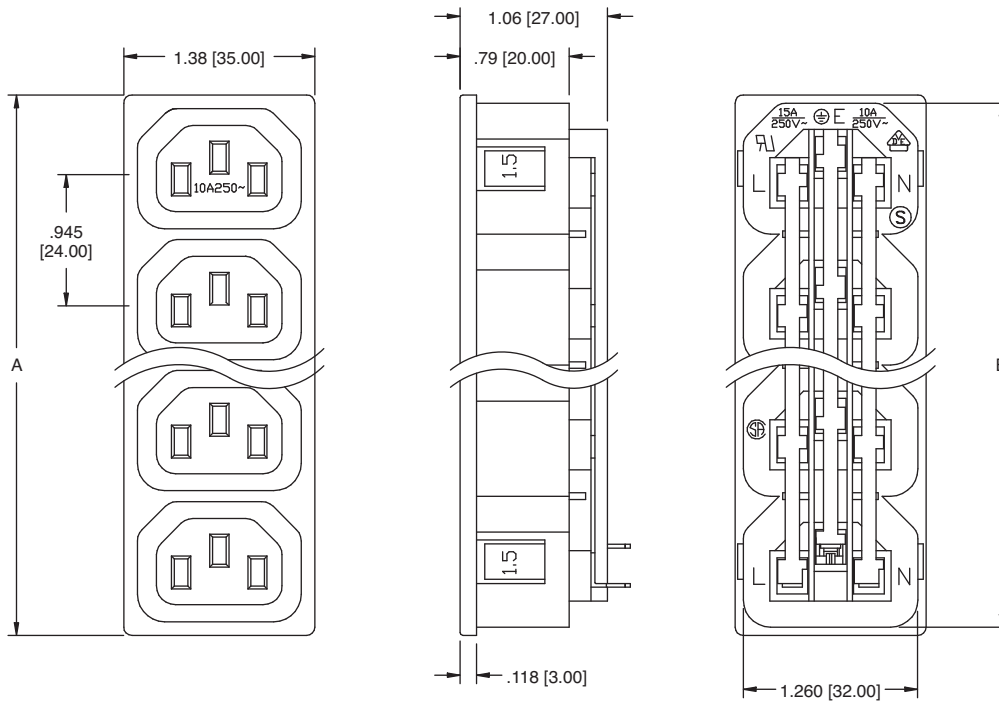

2 THRU 7 PORTS AVAILABLE

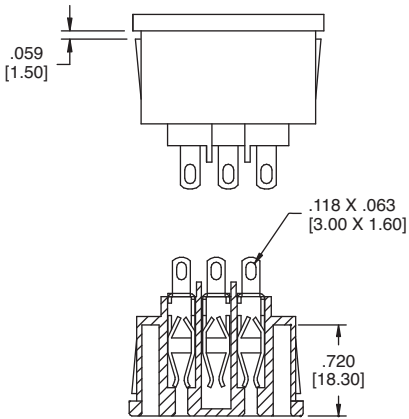

**Cross Section**

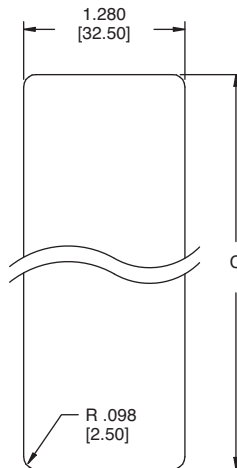

**Recommended Panel Cut-Out**



**IEC-D-S4-150**

DIMENSIONS				
PART NUMBER	PORTS	A	B	C
IEC-D-S2-150	2	2.007 [51.00]	1.890 [48.00]	1.901 [48.30]
IEC-D-S3-150	3	2.953 [75.00]	2.835 [72.00]	2.846 [72.30]
IEC-D-S4-150	4	3.897 [99.00]	3.780 [96.00]	3.791 [96.30]
IEC-D-S5-150	5	4.842 [123.00]	4.724 [120.00]	4.736 [120.30]
IEC-D-S6-150	6	5.787 [147.00]	5.670 [144.00]	5.681 [144.30]
IEC-D-S7-150	7	6.732 [171.00]	6.614 [168.00]	6.626 [168.30]

\*PART NUMBERS SHOWN ARE FOR 1.5mm PANEL THICKNESS. CONSULT FACTORY FOR OTHER PANEL THICKNESSES REQUIREMENTS

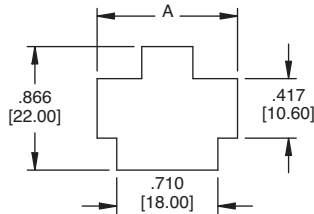
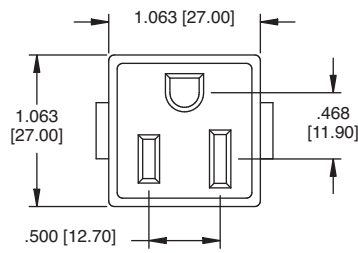

PANEL THICKNESS	DIM. A
.031 [0.80]	.945 [24.00]
.039 [1.00]	.968 [24.60]
.047 [1.20]	.992 [25.20]
.063 [1.60]	1.031 [26.20]

**NEMA-5-1  
UNIVERSAL  
PANEL SNAP**

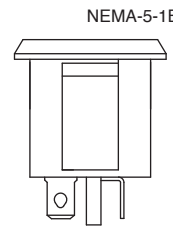
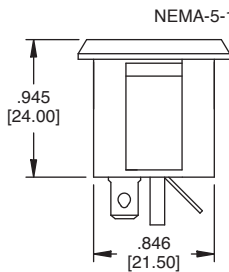
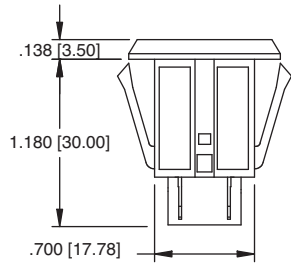

OPTIONAL STRAIGHT GROUND



**NEMA-5-1**

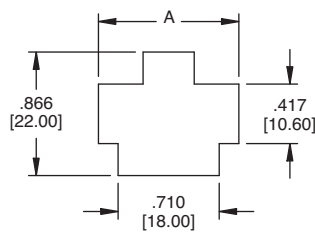
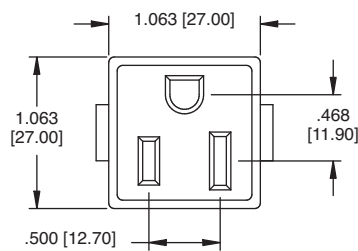

**NEMA-5-2  
UNIVERSAL  
PANEL SNAP  
12-14 Awg**

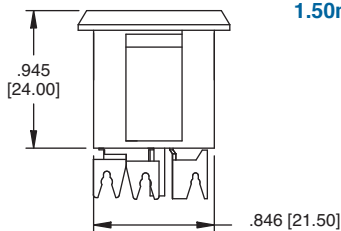
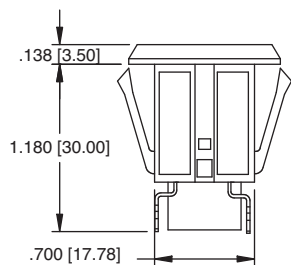

**Recommended  
Panel Cut-Out For  
1.50mm Panel Thickness**



**NEMA-5-2**

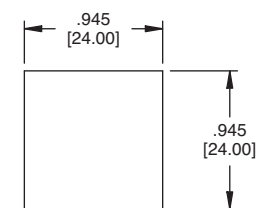
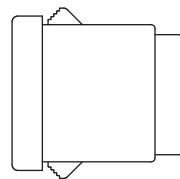
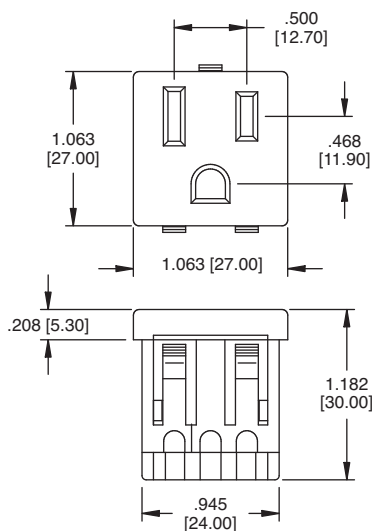

**Recommended Panel Cut-Out For  
Panel 0.8mm - 1.50mm**

**NEMA-5-3  
UNIVERSAL  
PANEL SNAP**



**NEMA-5-3**

	<p><b>IEC-NA-4</b> <b>UNIVERSAL PANEL SNAP</b></p> <p><b>Recommended Panel Cut-Out</b></p> <p><b>Recommended PCB Layout</b></p>
	<p><b>IEC-NB-4</b> <b>DEDICATED PANEL SNAP</b></p> <p><b>Recommended Panel Cut-Out</b></p> <p><b>Recommended PCB Layout</b></p>
	<p><b>IEC-NB-A-4</b> <b>SLIDE ON PANEL</b></p> <p><b>Recommended Panel Cut-Out</b></p> <p><b>Recommended PCB Layout</b></p>

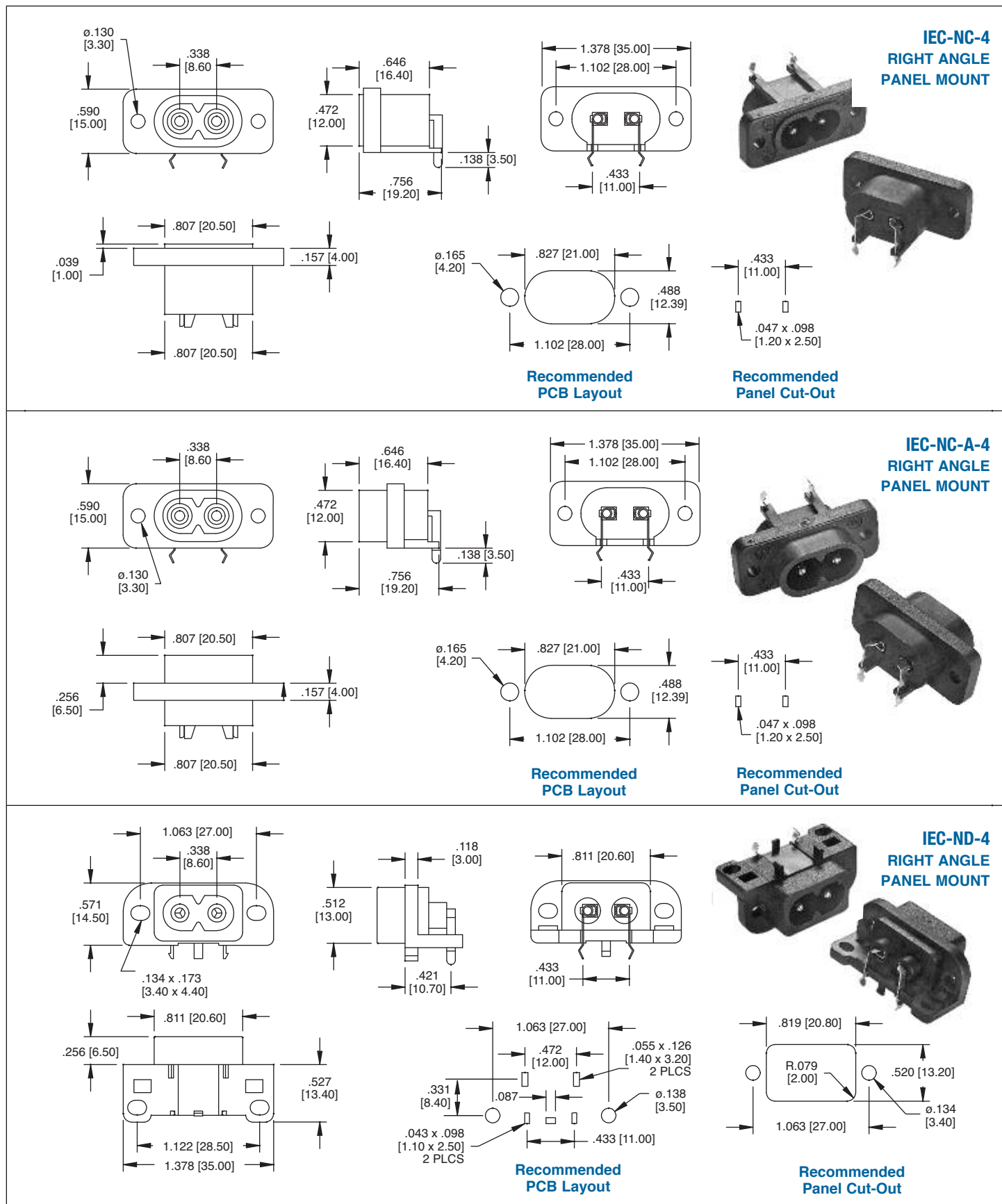

**IEC-NF-4  
RIGHT ANGLE  
PANEL MOUNT**

**Recommended  
PCB Layout**

**Recommended  
Panel Cut-Out**

**IEC-NH-4  
RIGHT ANGLE  
SLIDE ON PANEL**

**Recommended  
PCB Layout**

**Recommended  
Panel Cut-Out**

**IEC-NH-A-4  
RIGHT ANGLE  
SCREW ON PANEL MOUNT**

**Recommended  
PCB Layout**

**Recommended  
Panel Cut-Out**