

Rev	AWO #	Description	Date	Appr
-		RELEASED	5/22/15	

APPROVED: _____
 DATE: _____ TITLE: _____

DE09-HD-PX-SS

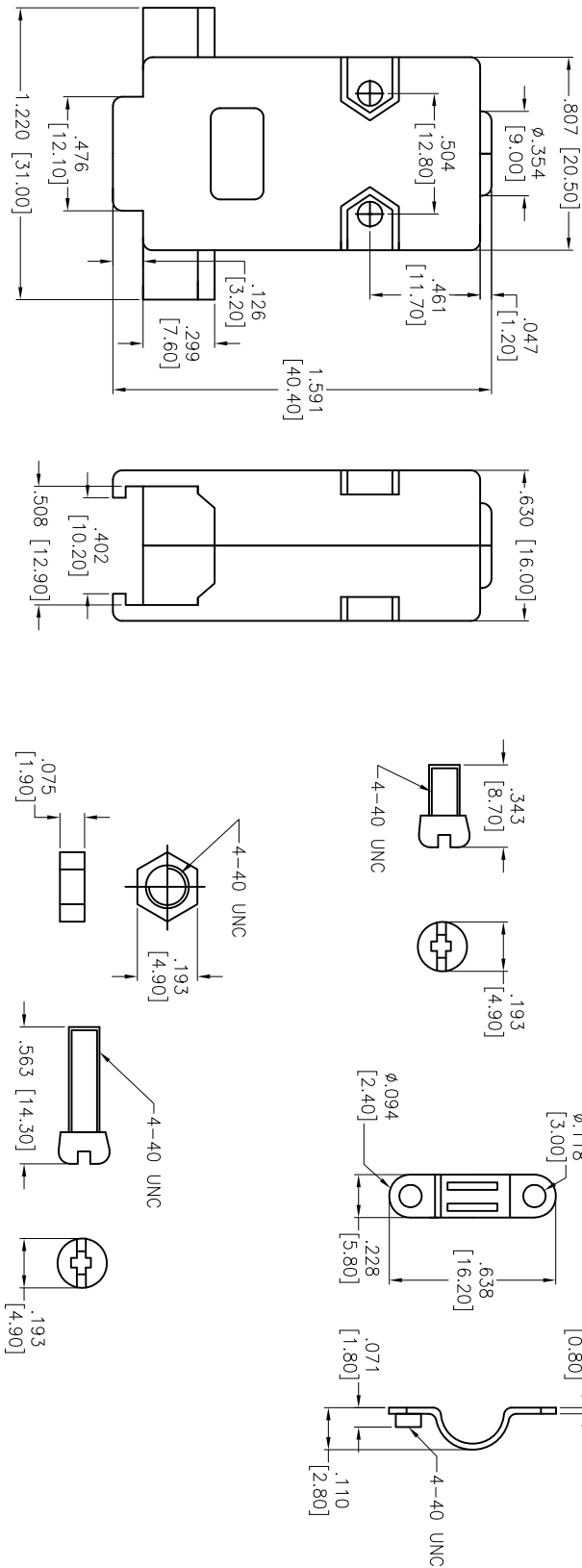
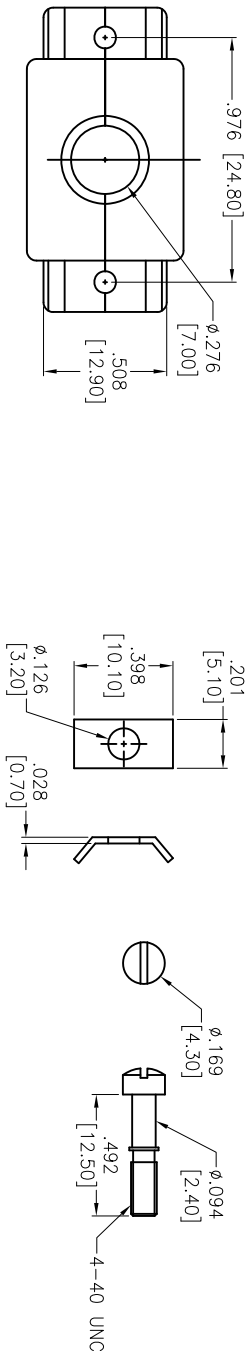

ADAM P/N	HOOD COLOR
DXXX-HD-PB-SS	BLACK PLASTIC
DXXX-HD-PN-SS	CHROME PLASTIC
DXXX-HD-PY-SS	GRAY PLASTIC

UNLESS OTHERWISE SPECIFIED ALL DIMENSIONS ARE INCHES [MM]	
TOLERANCES: EXCEPT AS NOTED	
INCHES	
.X ± .10	ØX ± .10
.XX ± .020	ØXX ± .015
.XXX ± .015	ØXXX ± .010
APPROVALS	DATE
DRAWN	HR
CHECKED	LL
APPROVED	

ADAM TECH
 909 Railway Avenue, Union, NJ 07083
 Phone: 908-687-5000 Fax: 908-687-5710

SPECIFICATIONS:
 Material:
 Insulator: ABS, rated UL 94HB
 Insulator color: Black
 Hardware: Steel, Chromate plated
 Environmental:
 Lead free, RoHS compliant



TITLE		PART NO.		REV.
D-SUB HOOD, SHORT SCREWS		DXXX-HD-PX-SS		-
REF:	S00064T	SCALE:	NTS	SHEET 1 OF 5

6

5

4

3

2

1

Rev	AWO #	Description	Date	Appr
		SEE SHT 1 OF 5 FOR REVISION		

APPROVED: _____

DATE: _____ TITLE: _____

DA15-HD-PX-SS

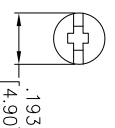
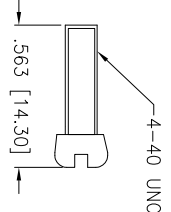
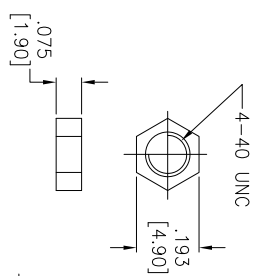
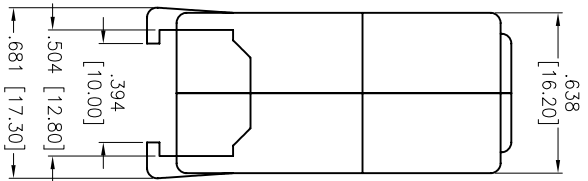
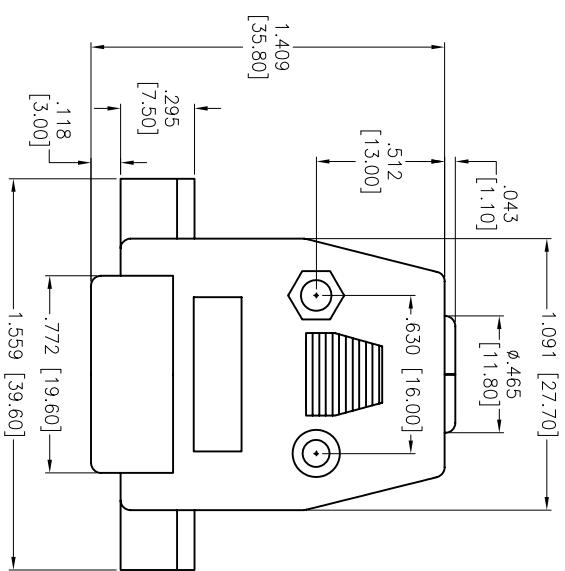
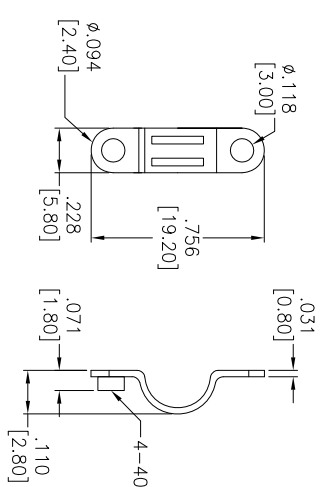
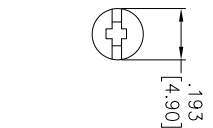
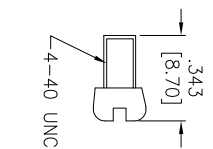
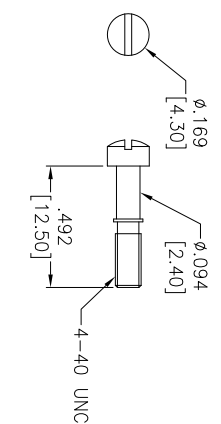
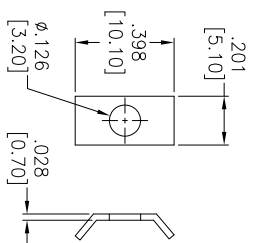
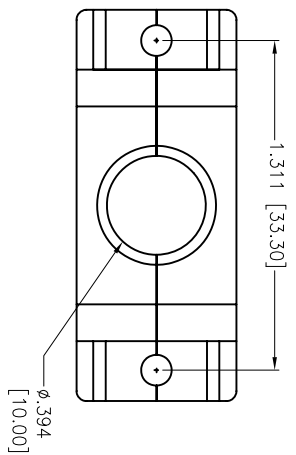

UNLESS OTHERWISE SPECIFIED
ALL DIMENSIONS ARE INCHES [MM]
TOLERANCES: EXCEPT AS NOTED

INCHES	± .10	ØXX	± .10
.XX	± .020	ØXXX	± .015
.XXX	± .015	ØXXXX	± .010

ADAM TECH
909 Railway Avenue, Union, NJ 07083
Phone: 908-687-5000 Fax: 908-687-5710

D-SUB HOOD, SHORT SCREWS

APPROVALS	DATE	TITLE
DRAWN	HR	5/22/15
CHECKED	LL	5/22/15
APPROVED		

SIZE	PART NO.	REV.
X	DXXX-HD-PX-SS	-
REF:	S00064T	SCALE: NTS
		SHEET 2 OF 5

A

B

C

D

A

B

C

D

6

5

4

3

2

1

6

5

4

3

2

1

Rev	AWO #	Description	Date	Appr
		SEE SH1 1 OF 5 FOR REVISION		

APPROVED: _____
 DATE: _____ TITLE: _____

DB25--HD--PX--SS

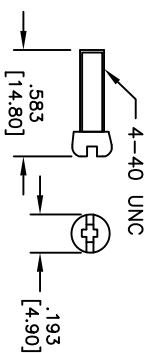
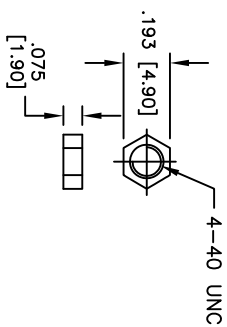
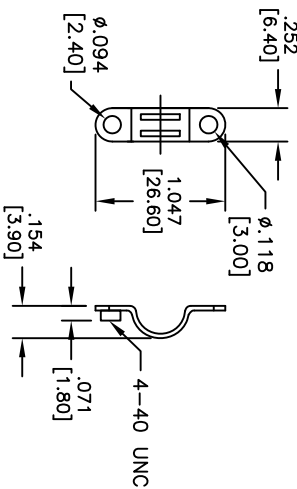
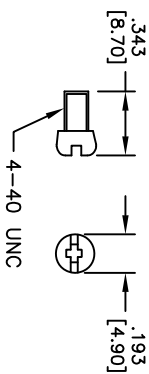
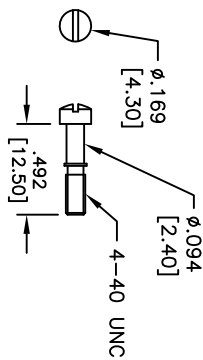
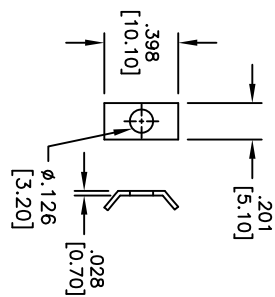
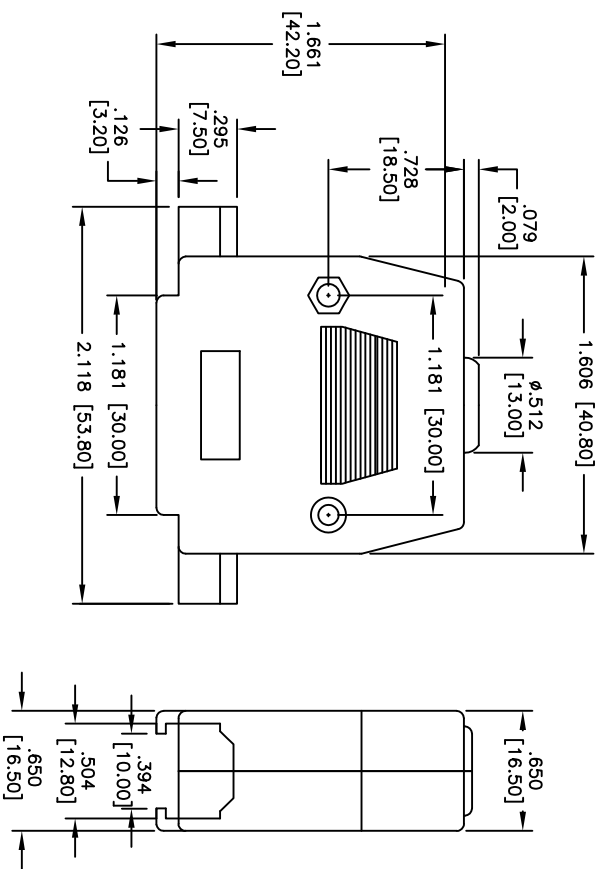
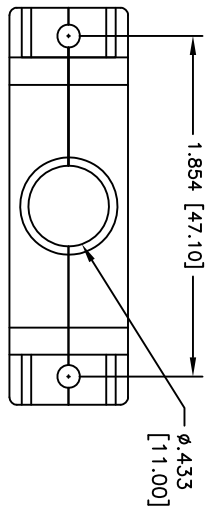

UNLESS OTHERWISE SPECIFIED
 ALL DIMENSIONS ARE IN INCHES [MM]
 TOLERANCES: EXCEPT AS NOTED
 INCHES Holes ±.10
 .X ±.10 ØXX ±.10
 .XX ±.020 ØXXX ±.015
 .XXX ±.015 ØXXXX ±.010

ADAM TECH
 909 Railway Avenue, Union, NJ 07083
 Phone: 908-687-5000 Fax: 908-687-5710

DRAWN		HR	5/22/15	SIZE	PART NO.	REV.
CHECKED		LL	5/22/15	X	DXXX-HD-PX-SS	-
APPROVALS		DATE		REF:	S000&T	SHEET 3 OF 5
TITLE		D-SUB HOOD, SHORT SCREWS				

A

B

C

D

A

B

C

D

6

5

4

3

2

1

6

5

4

3

2

1

Rev	AWC #	Description	Date	Appr
		SEE SHIT 1 OF 5 FOR REVISION		

APPROVED: _____
 DATE: _____ TITLE: _____

DC37--HD--PX--SS

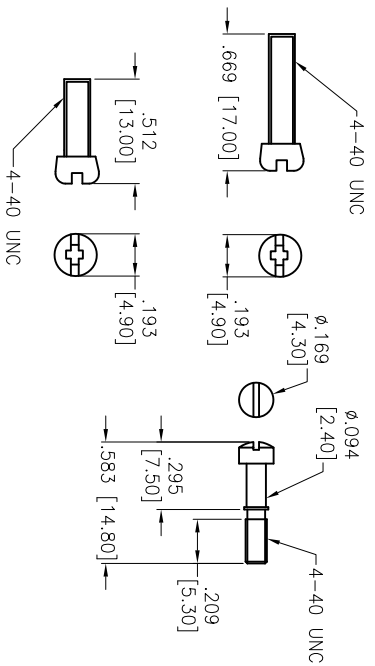
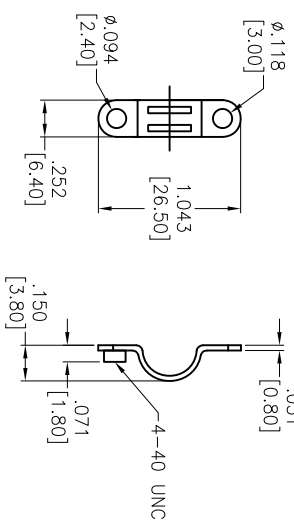
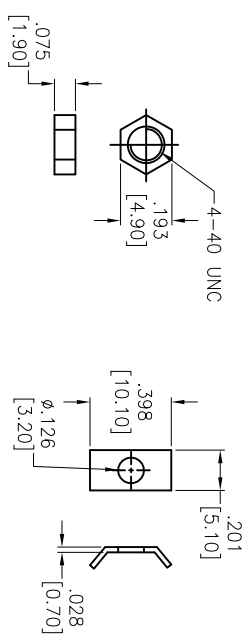
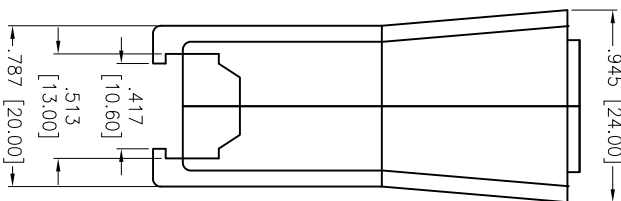
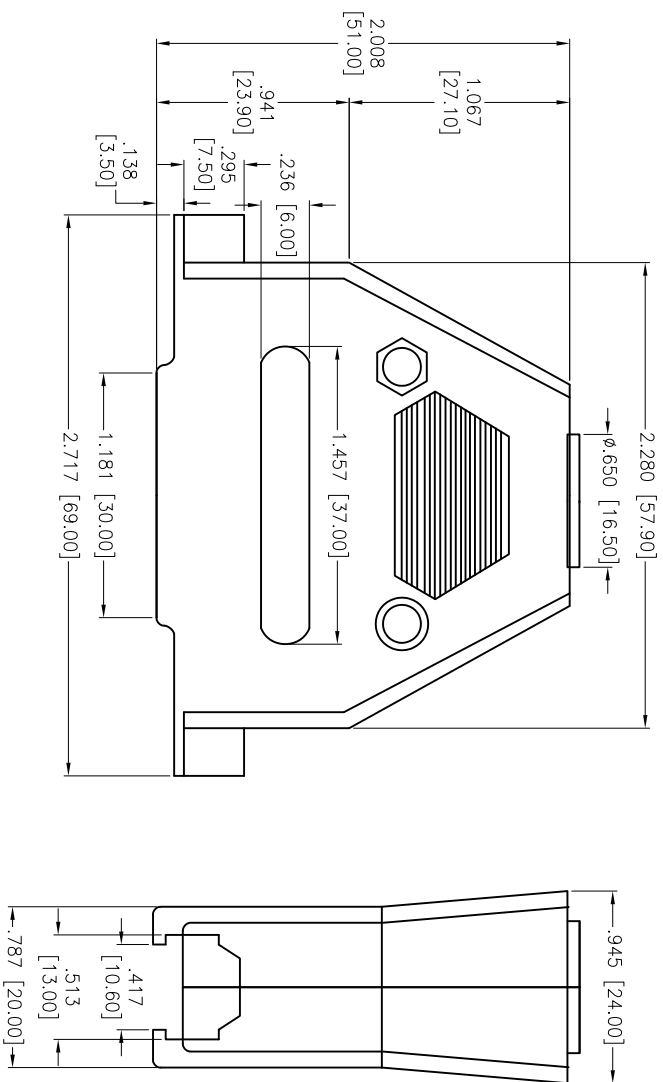
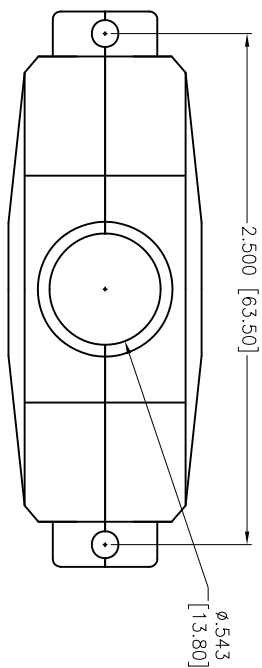

UNLESS OTHERWISE SPECIFIED
 ALL DIMENSIONS ARE IN INCHES [MM]
 TOLERANCES: EXCEPT AS NOTED

INCHES	± .10	ØXX	± .10
INCHES	± .020	ØXXX	± .015
INCHES	± .015	ØXXXX	± .010

APPROVALS

DRAWN	HR	5/22/15
CHECKED	LL	5/22/15
APPROVED		

TITLE: D-SUB HOOD, SHORT SCREWS

909 Railway Avenue, Union, NJ 07083
 Phone: 908-687-5000 Fax: 908-687-5710

ADAM TECH

SIZE PART NO. DXXX-HD-PX-SS
 REF: S0002AT SCALE: NTS SHEET 4 OF 5

6

5

4

3

2

1

6

5

4

3

2

1

Rev	AWO #	Description	Date	Appr
		SEE SH1 1 OF 5 FOR REVISION		

APPROVED: _____
 DATE: _____ TITLE: _____

DD50-HD-PX-SS

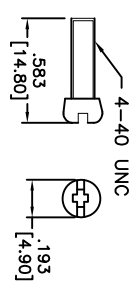
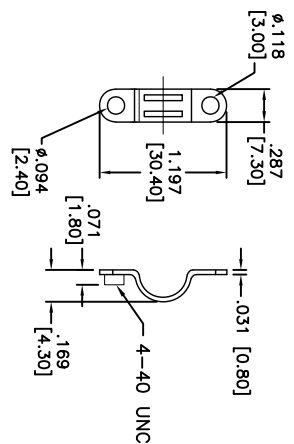
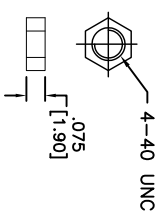
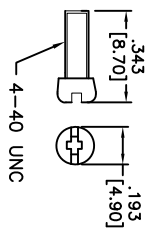
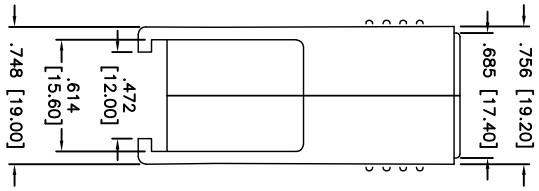
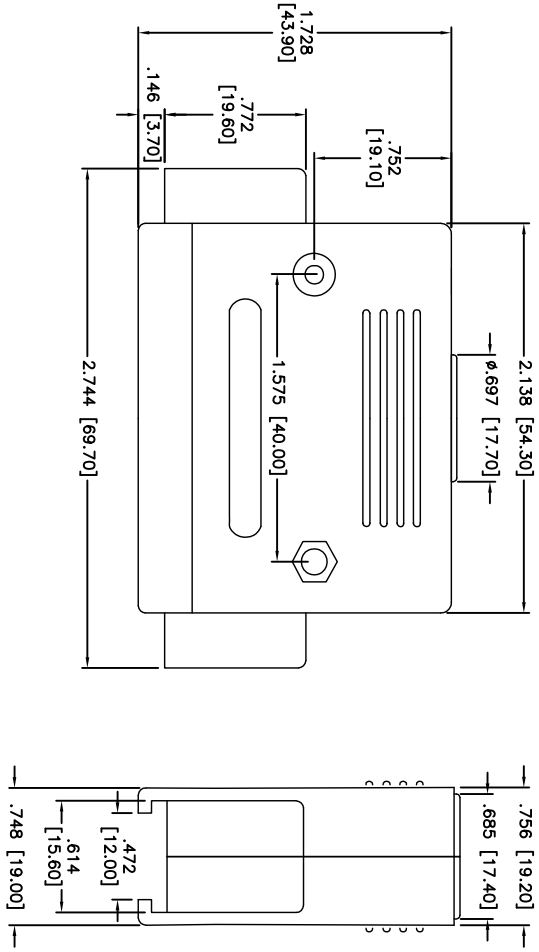
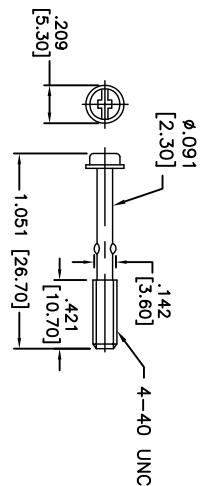
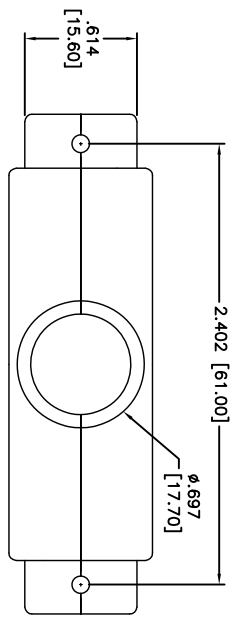

UNLESS OTHERWISE SPECIFIED
 ALL DIMENSIONS ARE MM [INCHES]
 TOLERANCES: EXCEPT AS NOTED
 INCHES: ±.10
 .XX ±.020
 .XXX ±.015
 .XXX ±.010

ADAM TECH
 909 Rahway Avenue, Union, NJ 07083
 Phone: 908-687-5000 Fax: 908-687-5710

D-SUB HOOD, SHORT SCREWS

APPROVALS	DATE
DRAWN HR	5/22/15
CHECKED LL	5/22/15
APPROVED	

SIZE	PART NO.	REV.
X	DXXX-HD-PX-SS	-
REF: S00084T	SCALE: NTS	SHEET 5 OF 5

A

B

C

D

A

B

C

D

6

5

4

3

2

1