

FEATURES

- SURFACE MOUNTABLE 0201 ~ 7520 CASE SIZE
- PRECISION TOLERANCE ($\pm 1\%$)
- POWER RATINGS UP TO 3 WATTS
- Pb-FREE REFLOW COMPATIBLE

RoHS Compliant
includes all homogeneous materials



*See Part Number System for Details

CHARACTERISTICS

Type	EIA Size	Power Rating at 70°C	Resistance Tolerance	Temperature Coefficient (°C)	Resistance Range	Resistance Range (Codes)	Operating Temp. Range (°C)
NCST02	0201	1/20W	1% (F) 2% (G) 5% (J)	± 300 ppm (G)	501m Ω ~ 1 Ω	R501 ~ 1R00	-55°C ~ +155°C
				± 600 ppm (J)	150m Ω ~ 500m Ω	R150 ~ R500	
				± 1000 ppm (R)	100m Ω ~ 149m Ω	R100 ~ R149	
NCST04	0402	1/16W	1% (F) 2% (G) 5% (J)	± 200 ppm (F)	501m Ω ~ 1 Ω	R501 ~ 1R00	
				± 300 ppm (G)	101m Ω ~ 500m Ω	R101 ~ R500	
				± 400 ppm (H)	50m Ω ~ 100m Ω	R050 ~ R100	
NCST06	0603	1/10W	1% (F) 2% (G) 5% (J)	± 200 ppm (F)	501m Ω ~ 1 Ω	R501 ~ 1R00	
				± 300 ppm (G)	101m Ω ~ 500m Ω	R101 ~ R500	
				± 400 ppm (H)	51m Ω ~ 100m Ω	R051 ~ R100	
				± 600 ppm (J)	20m Ω ~ 50m Ω	R020 ~ R050	
NCST10	0805	1/8W	1% (F) 2% (G) 5% (J)	± 200 ppm (F)	200m Ω ~ 1 Ω	R200 ~ 1R00	
				± 300 ppm (G)	101m Ω ~ 199m Ω	R101 ~ R199	
				± 400 ppm (H)	51m Ω ~ 100m Ω	R051 ~ R100	
				± 600 ppm (J)	20m Ω ~ 50m Ω	R020 ~ R050	
NCST12*	1206	1/4W	1% (F) 2% (G) 5% (J)	± 200 ppm (F)	100m Ω ~ 1 Ω	R100 ~ 1R00	
NCST25*	1210	1/2W		± 300 ppm (G)	51m Ω ~ 99m Ω	R051 ~ R099	
NCST50*	2010	3/4W					
NCST100*	2512	1W		± 400 ppm (H)	21m Ω ~ 50m Ω	R021 ~ R050	

Sizes and Values Table Continues on Next Page

PART NUMBER SYSTEM

NCST10 F R501 F TR F

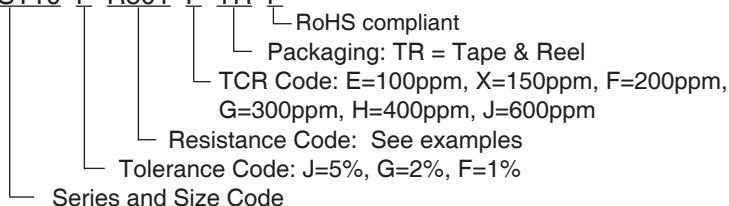

CHARACTERISTICS

Type	EIA Size	Power Rating at 70°C	Resistance Tolerance	Temperature Coefficient (°C)	Resistance Range	Resistance Range (Codes)	Operating Temp. Range (°C)
NCST100L	3720	1W	1% (F) 2% (G) 5% (J)	±150ppm (X)	20mΩ ~ 500mΩ	R020 ~ R500	-55°C ~ +155°C
				±300ppm (G)	10mΩ ~ 18mΩ	R010 ~ R018	
NCST100LR	0612	1W	1% (F) 2% (G) 5% (J)	±200ppm (F)	100mΩ ~ 1Ω	R100 ~ 1R00	
				±300ppm (G)	30mΩ ~ 91Ω	R030 ~ R091	
				±600ppm (J)	10mΩ ~ 27mΩ	R010 ~ R027	
NCST200	0830	2W	2% (G) 5% (J) 1% (F) 2% (G) 5% (J)	±300ppm (G)	1mΩ ~ 4mΩ	R001 ~ R004	
				±150ppm (X)	11mΩ ~ 350mΩ	R011 ~ R350	
				±200ppm (F)	5mΩ ~ 10mΩ	R005 ~ R010	
NCST300	1225	3W	1% (F) 2% (G) 5% (J)	±100ppm (E)	31mΩ ~ 3.0Ω	R031 ~ 1R00	
				±150ppm (X)	21mΩ ~ 30mΩ	R021 ~ R030	
				±200ppm (F)	6mΩ ~ 20mΩ	R006 ~ R020	
				±300ppm (G)	3mΩ ~ 5mΩ	R003 ~ R005	

*Available with a ±100ppm (E) TCR (100mΩ ~ 1Ω)

Power Derating Curve: For operation above 70°C, power rating must be derated according to the following chart:

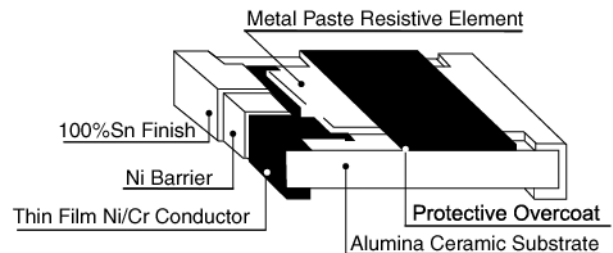
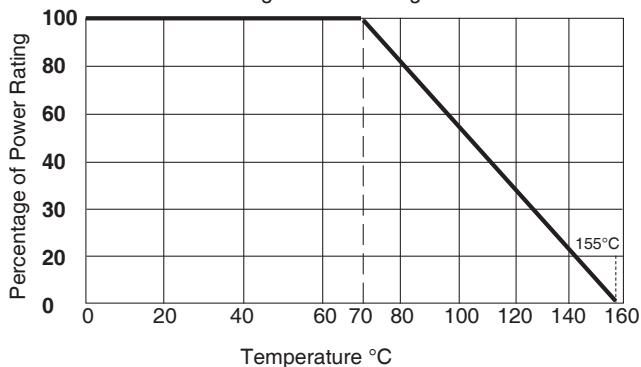

ENVIRONMENTAL CHARACTERISTICS

Item	Specification	Test Method
Temperature Coefficient of Resistance	As Specified	JIS-C-5201-1 4.8 IEC-60115-1 4.8 -55°C ~ +125°C, 25°C reference
Thermal Shock	±0.5% + 0.05Ω	JIS-C-5201-1 4.19 IEC-60115-1 4.19 -55°C ~ +155°C, 5 cycles
Short Time Overload	±0.5% + 0.05Ω	JIS-C-5201-1 4.13 IEC-60115-1 4.13 RCWV * 2.5 or max. overload voltage whichever is less for 5 seconds
Dielectric Withstanding Voltage	No breakdown or flashover	JIS-C-5201-1 4.7 IEC-60115-1 4.7 1.42 times max operating voltage for 1 minute
Insulation Resistance	>10000MΩ	JIS-C-5201-1 4.6 IEC-60115-1 4.6 Maximum overload voltage for 1 minute
Resistance to dry heat	±0.5% + 0.05Ω	JIS-C-5201-1 4.23 IEC-60115-1 4.23.2 +155°C for 1,000 hours
Load Life	±1% + 0.05Ω	JIS-C-5201-1 4.25 IEC-60115-1 4.25.1 RCWV @ 70°C, cycles of 1.5 hours ON, 0.5 hrs OFF for 1,000 hours
Resistance to Soldering Heat	±0.5% + 0.05Ω	JIS-C-5201-1 4.18 IEC-60115-1 4.18 +260°C ±5°C for 10 sec.
Humidity (Steady State)	±0.5% + 0.05Ω	JIS-C-5201-1 4.24 IEC-60115-1 4.24 +40°C, 90 ~ 95% RH, RCWV 1.5 hours ON, 0.5 hours OFF, total 1000 hours
Solderability	95% min. coverage	JIS-C-5201-1 4.17 IEC-60115-1 4.17 +245°C ±5°C for 3 sec.
Leaching	Individual leaching area ≤5% Total leaching area ≤10%	JIS-C-5201-1 4.18 IEC-60068-2-58 8.2.1 +260°C ±5°C for 30 sec.
Bending Strength	±1% + 0.05Ω	JIS-C-5201-1 4.33 IEC-60115-1 4.33 3mm for 5 seconds (2mm for 2010 & 2512)



AVAILABLE VALUES AND PART NUMBERS

	Available Value Range	Part Number	Resistance Value (mΩ)	Available TCR
0201 Size 1/20W	100mΩ ~ 149mΩ	NCST02 * R100NTRF	100	±1000ppm (R)
		↓	↓	
		NCST02 * R149NTRF	149	
	150mΩ ~ 500mΩ	NCST02 * R150JTRF	150	±600ppm (J)
		↓	↓	
		NCST02 * R500JTRF	500	
501mΩ ~ 1.0Ω	NCST02 * R501GTRF	501	±300ppm (G)	
	↓	↓		
	NCST02 * 1R00GTRF	1,000		
	Available Value Range	Part Number	Resistance Value (mΩ)	Available TCR
0402 Size 1/16W	50mΩ ~ 100mΩ	NCST04 * R050HTRF	50	±400ppm (H)
		↓	↓	
		NCST04 * R100HTRF	100	
	101mΩ ~ 500mΩ	NCST04 * R101GTRF	101	±300ppm (G)
		↓	↓	
		NCST04 * R500FTRF	500	
501mΩ ~ 1.0Ω	NCST04 * R501FTRF	501	±200ppm (F)	
	↓	↓		
	NCST04 * 1R00FTRF	1,000		
	Available Value Range	Part Number	Resistance Value (mΩ)	Available TCR
0603 Size 1/10W	20mΩ ~ 50mΩ	NCST06 * R020JTRF	20	±600ppm (J)
		↓	↓	
		NCST06 * R050JTRF	50	
	51mΩ ~ 100mΩ	NCST06 * R051HTRF	51	±400ppm (H)
		↓	↓	
		NCST06 * R100HTRF	100	
101mΩ ~ 500mΩ	NCST06 * R101GTRF	101	±300ppm (G)	
	↓	↓		
	NCST06 * R500GTRF	500		
501mΩ ~ 1.0Ω	NCST06 * R501FTRF	501	±200ppm (F)	
	↓	↓		
	NCST06 * 1R00FTRF	1,000		
	Available Value Range	Part Number	Resistance Value (mΩ)	Available TCR
0805 Size 1/8W	20mΩ ~ 50mΩ	NCST10 * R020JTRF	20	±600ppm (J)
		↓	↓	
		NCST10 * R050JTRF	50	
	51mΩ ~ 100mΩ	NCST10 * R051HTRF	51	±400ppm (H)
		↓	↓	
		NCST10 * R100HTRF	100	
101mΩ ~ 199mΩ	NCST10 * R101GTRF	101	±300ppm (G)	
	↓	↓		
	NCST10 * R199GTRF	199		
200mΩ ~ 1.0Ω	NCST10 * R200FTRF	200	±200ppm (F)	
	↓	↓		
	NCST10 * 1R00FTRF	1,000		

*Tolerance Codes: 1% (F), 2% (G) or 5% (J)

TABLE CONTINUES ON NEXT PAGE



AVAILABLE VALUES AND PART NUMBERS

	Available Value Range	Part Number	Resistance Value (mΩ)	Available TCR
1206 Size 1/4W	10mΩ ~ 20mΩ	NCST12 * R010JTRF	10	±600ppm (J)
		↓	↓	
		NCST12 * R020JTRF	20	
	21mΩ ~ 50mΩ	NCST12 * R021HTRF	21	±400ppm (H)
		↓	↓	
		NCST12 * R050HTRF	50	
	51mΩ ~ 100mΩ	NCST12 * R051GTRF	51	±300ppm (G)
		↓	↓	
		NCST12 * R100GTRF	100	
	101mΩ ~ 1.0Ω	NCST12 * R101FTRF	101	±200ppm (F)
		↓	↓	
		NCST12 * 1R00FTRF	1,000	
100mΩ ~ 1.0Ω	NCST12 * R100ETRF	100	±100ppm (E)	
	↓	↓		
	NCST12 * 1R00ETRF	1,000		
	Available Value Range	Part Number	Resistance Value (mΩ)	Available TCR
1210 Size 1/2W	10mΩ ~ 20mΩ	NCST25 * R010JTRF	10	±600ppm (J)
		↓	↓	
		NCST25 * R020JTRF	20	
	21mΩ ~ 50mΩ	NCST25 * R021HTRF	21	±400ppm (H)
		↓	↓	
		NCST25 * R050HTRF	50	
	51mΩ ~ 500mΩ	NCST25 * R051GTRF	51	±300ppm (G)
		↓	↓	
		NCST25 * R100GTRF	100	
	501mΩ ~ 1.0Ω	NCST25 * R101FTRF	101	±200ppm (F)
		↓	↓	
		NCST25 * 1R00FTRF	1,000	
100mΩ ~ 1.0Ω	NCST25 * R100ETRF	100	±100ppm (E)	
	↓	↓		
	NCST25 * 1R00ETRF	1,000		
	Available Value Range	Part Number	Resistance Value (mΩ)	Available TCR
2010 Size 3/4W	10mΩ ~ 20mΩ	NCST50 * R010JTRF	10	±600ppm (J)
		↓	↓	
		NCST50 * R020JTRF	20	
	21mΩ ~ 50mΩ	NCST50 * R021HTRF	21	±400ppm (H)
		↓	↓	
		NCST50 * R050HTRF	50	
	51mΩ ~ 100mΩ	NCST50 * R051GTRF	51	±300ppm (G)
		↓	↓	
		NCST50 * R100GTRF	100	
	101mΩ ~ 1.0Ω	NCST50 * R101FTRF	101	±200ppm (F)
		↓	↓	
		NCST50 * 1R00FTRF	1,000	
100mΩ ~ 1.0Ω	NCST50 * R100ETRF	100	±100ppm (E)	
	↓	↓		
	NCST50 * 1R00ETRF	1,000		

*Tolerance Codes: 1% (F), 2% (G) or 5% (J)

TABLE CONTINUES ON NEXT PAGE



AVAILABLE VALUES AND PART NUMBERS

	Available Value Range	Part Number	Resistance Value (mΩ)	Available TCR
2512 Size 1W	10mΩ ~ 20mΩ	NCST100 * R010JTRF	10	±600ppm (J)
		↓	↓	
		NCST100 * R020JTRF	20	
	21mΩ ~ 50mΩ	NCST100 * R021HTRF	21	±400ppm (H)
		↓	↓	
		NCST100 * R050HTRF	50	
	51mΩ ~ 100mΩ	NCST100 * R051GTRF	51	±300ppm (G)
		↓	↓	
		NCST100 * R100GTRF	100	
	101mΩ ~ 1.0Ω	NCST100 * R101FTRF	501	±200ppm (F)
		↓	↓	
		NCST100 * 1R00FTRF	1,000	
100mΩ ~ 1.0Ω	NCST100 * R100ETRF	100	±100ppm (E)	
	↓	↓		
	NCST100 * 1R00ETRF	1,000		
	Available Value Range	Part Number	Resistance Value (mΩ)	Available TCR
3720 Size 1W	10mΩ ~ 18mΩ	NCST100L * R010GTRF	10	±300ppm (G)
		↓	↓	
		NCST100L * R018GTRF	18	
	20mΩ ~ 500Ω	NCST100L * R020XTRF	20	±150ppm (X)
		↓	↓	
NCST100L * R500XTRF	500			
	Available Value Range	Part Number	Resistance Value (mΩ)	Available TCR
0612 Size 1W	10mΩ ~ 27mΩ	NCST100LR * R010JTRF	10	±600ppm (J)
		↓	↓	
		NCST100LR * R027JTRF	27	
	30mΩ ~ 91Ω	NCST100LR * R030GTRF	30	±300ppm (G)
		↓	↓	
	NCST100LR * R091GTRF	91		
100mΩ ~ 1.0Ω	NCST100LR * R100FTRF	51	±200ppm (F)	
	↓	↓		
NCST100LR * 1R00FTRF	1,000			
	Available Value Range	Part Number	Resistance Value (mΩ)	Available TCR
0830 Size 2W	1mΩ ~ 4mΩ	NCST200 * R001GTRF	1	±300ppm (G)
		↓	↓	
		NCST200 * R004GTRF	4	
	5mΩ ~ 10mΩ	NCST200 * R005FTRF	5	±200ppm (F)
		↓	↓	
	NCST200 * R010FTRF	10		
	11mΩ ~ 350mΩ	NCST200 * R011XTRF	51	±150ppm (X)
↓		↓		
NCST200 * R350XTRF	500			
	Available Value Range	Part Number	Resistance Value (mΩ)	Available TCR
1225 Size 3W	3mΩ ~ 5mΩ	NCST300 * R003GTRF	3	±300ppm (G)
		↓	↓	
		NCST300 * R005GTRF	5	
	6mΩ ~ 20mΩ	NCST300 * R006FTRF	6	±200ppm (F)
		↓	↓	
		NCST300 * R020FTRF	20	
	21mΩ ~ 30mΩ	NCST300 * R021XTRF	21	±150ppm (X)
		↓	↓	
		NCST300 * R030XTRF	30	
	31mΩ ~ 3.0Ω	NCST300 * R031ETRF	31	±100ppm (E)
↓		↓		
NCST300 * 3R00ETRF		3,000		

*Tolerance Codes: 1% (F), 2% (G) or 5% (J)



DIMENSIONS (mm)

Type	Case Size	Length (L)	Width (W)	Thickness (T)	Termination Width (P ₁)	Termination Width (P ₂)
NCST02	0201	0.60 ± 0.03	0.30 ± 0.03	0.23 ± 0.05	0.12 ± 0.05	0.15 ± 0.05
NCST04	0402	1.00 ± 0.05	0.50 ± 0.05	0.32 ± 0.05	0.25 ± 0.10	0.20 ± 0.10
NCST06	0603	1.60 ± 0.10	0.80 ± 0.10	0.45 ± 0.10	0.30 ± 0.20	0.30 ± 0.20
NCST10	0805	2.00 ± 0.10	1.25 ± 0.10	0.50 ± 0.10	0.30 ± 0.20	0.30 ± 0.20
NCST12	1206	3.05 ± 0.15	1.55 ± 0.15	0.60 ± 0.10	0.50 ± 0.20	0.40 ± 0.20
NCST25	1210	5.00 ± 0.10	2.50 ± 0.15	0.60 ± 0.15	0.60 ± 0.30	0.50 ± 0.25
NCST50	2010	5.00 ± 0.20	2.45 ± 0.15	0.60 ± 0.10	0.60 ± 0.30	0.50 ± 0.25
NCST100	2512	6.35 ± 0.20	3.15 ± 0.15	0.60 ± 0.10	0.60 ± 0.30	0.50 ± 0.25
NCST100L	3720	2.00 ± 0.20	3.75 ± 0.20	0.60 ± 0.10	0.40 ± 0.20	0.40 ± 0.20
NCST100LR	0612	1.55 ± 0.10	3.10 ± 0.15	0.55 ± 0.10	0.30 ± 0.15	0.45 ± 0.15
NCST200	0830	2.00 ± 0.20	7.50 ± 0.30	0.60 ± 0.10	0.40 ± 0.20	0.40 ± 0.20
NCST300	1225	3.10 ± 0.15	6.30 ± 0.15	0.90 ± 0.15	0.60 ± 0.30	0.55 ± 0.25

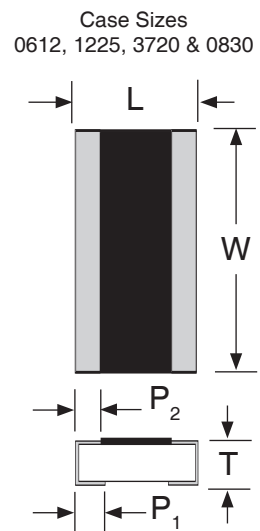
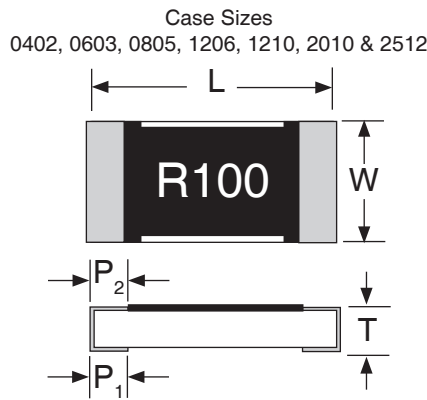
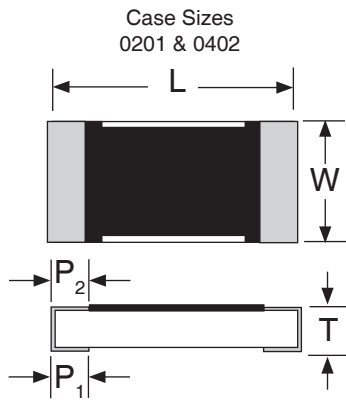

LAND PATTERN DIM. (mm)

	A	B	C
NCST02	0.30	0.25	0.40 ± 0.2
NCST04	0.50	0.50	0.60 ± 0.2
NCST06	1.00	0.80	0.90 ± 0.2
NCST10	1.00	1.00	1.35 ± 0.2
NCST12	1.15	2.00	1.70 ± 0.2
NCST25	1.15	2.00	2.50 ± 0.2
NCST50	1.40	3.60	2.50 ± 0.2
NCST100	1.60	4.90	3.10 ± 0.2
NCST100L	1.80	1.00	3.90 ± 0.2
NCST100LR	1.00	0.60	3.20 ± 0.2
NCST200	1.80	1.00	7.60 ± 0.2
NCST300	2.00	1.20	7.00 ± 0.2

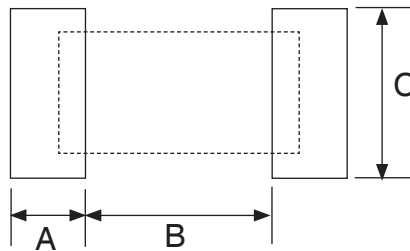

PAPER CARRIER TAPE DIMENSIONS (mm)

Type	A	B	W	F	E	P ₁	P ₂	P ₀	φD	T
NCST02	0.38 ± 0.05	0.68 ± 0.05	8.00 ±0.20	3.50 ±0.05	1.75 ±0.10	2.00 ± 0.05	2.00 ±0.05	4.00 ±0.10	1.50 +0.1/-0	0.42 ± 0.20
NCST04	0.65 ± 0.10	1.15 ± 0.10				0.45 ± 0.10				
NCST06	1.10 ± 0.10	1.90 ± 0.10				0.70 ± 0.10				
NCST10	1.60 ± 0.10	2.40 ± 0.20				0.85 ± 0.10				
NCST12	1.90 ± 0.10	3.50 ± 0.20								
NCST25	2.90 ± 0.10	3.50 ± 0.20								
NCST100L	1.90 ± 0.10	3.50 ± 0.20				4.00 ± 0.05				

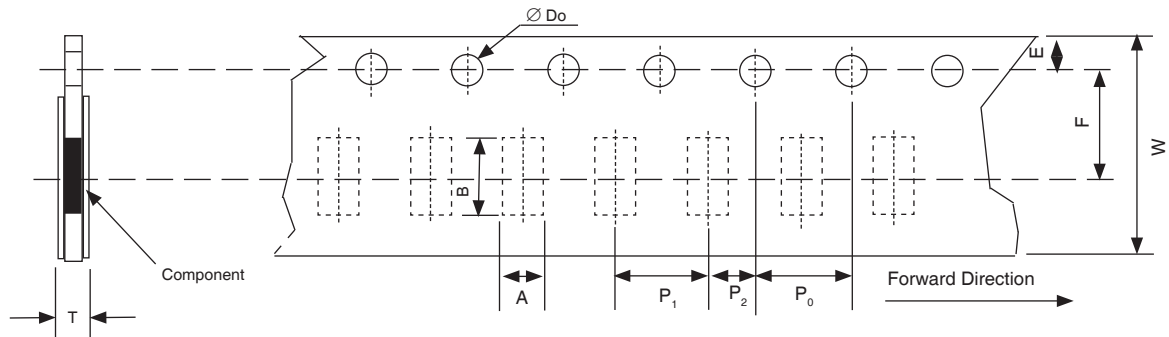

EMBOSSED PLASTIC CARRIER DIMENSIONS (mm)

Type	A	B	W	F	K	E	P ₁	P ₂	P ₀	φD _o	T
NCST50	2.80 ± 0.10	5.50 ± 0.10	12.0 ±0.30	5.50 ±0.05	1.00 ±0.20	1.75 ±0.10	4.00 ±0.10	2.00 ±0.05	4.00 ±0.05	1.50 ±0.05	0.80 ±0.10
NCST100	3.50 ± 0.10	6.70 ± 0.10									
NCST200	2.50 ± 0.20	8.30 ± 0.20									
NCST300	3.38 ± 0.10	6.68 ± 0.10	12.0 ±0.30	5.50 ±0.10	1.45 ±0.20						

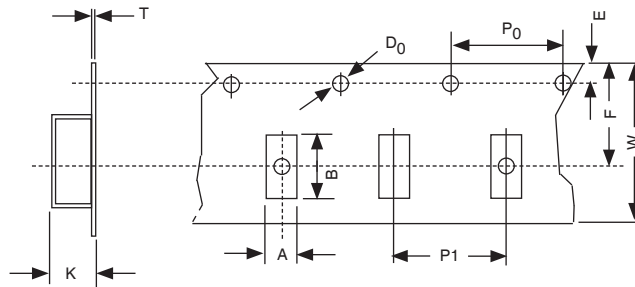

REEL DIMENSIONS (mm) AND QUANTITY

Type	A	B	C	W	Quantity
NCST02	178 ±1.0	60 +1.0	13 ±0.7	9.5 ±0.1	10,000
NCST04					5,000
NCST06				4,000	
NCST10					13.5 ±1.0
NCST12				9.5 ±1.0	
NCST25					5,000
NCST50				17.5 ±1.0	
NCST100					2,000
NCST100L				13.5 ±1.0	
NCST200					2,000
NCST300					

