

FEATURES

- HIGH Q FOR RF APPLICATIONS
- STABLE NPO CHARACTERISTICS OVER TEMPERATURE AND VOLTAGE
- HIGH VOLTAGE (UP TO 500VDC)
- EIA 0201, 0402, 0505, 0603 AND 0805 CASE SIZES
- IDEAL FOR WIRELESS DATA AND VOICE COMMUNICATIONS APPLICATIONS
WLANs, HIPERLAN, 802.11A, 802.11B, Wi-Fi, BLUETOOTH, TELEMATICS, PCS, LMDS AND CELLULAR



SPECIFICATIONS	NPO	
Capacitance Range	0.1pF ~ 100pF	
Capacitance Tolerance	±0.05pF(A), ±0.1pF(B), ±0.25pF(C), ±0.5pF(D) ±1%(F), ±2%(G), ±5%(J)	
Operating Temperature Range	-55°C ~ +125°C	
Temperature Characteristics	0 ± 30PPM/°C	
Rated Voltage	6.3Vdc, 10Vdc, 25Vdc, 50Vdc, 100Vdc, 250Vdc & 500Vdc	
Q Factor (1MHz, 1.0Vrms, +25°C)	0201	C < 30pF Q ≥ 400+20xC
	0402 (25V ~ 50V)	C ≥ 30pF Q ≥ 1000
	0402 (100V ~ 200V)	C < 30pF Q ≥ 800+20xC
	0603, 0505 & 0805	C ≥ 30pF Q ≥ 1400
insulation Resistance	10,000 Megohms min. @ +25°C	
Dielectric Withstanding Voltage	≤100V x 2.5RV, ≥200V x 2RV for 5 ± 1 seconds	

**RoHS
Compliant**

Includes all homogeneous materials

*See Part Number System for Details

DIMENSIONS (mm)

EIA Case Size	0201	0402	0505	0603	0805
Length (L)	0.6 ± 0.03	1.0 ± 0.05	1.40 +0.38/-0.25	1.6 ± 0.10	2.0 ± 0.20
Width (W)	0.3 ± 0.03	0.5 ± 0.05	1.40 ± 0.38	0.8 ± 0.10	1.25 ± 0.20
Thickness (T)	0.33 max.	0.55 max.	1.30 max.	0.87 max.	0.70 max. (0.2pF) 0.95 max.
Termination Width (P)	0.10 ~ 0.20	0.15 ~ 0.30	0.12 ~ 0.50	0.25 ~ 0.55	0.30 ~ 0.70

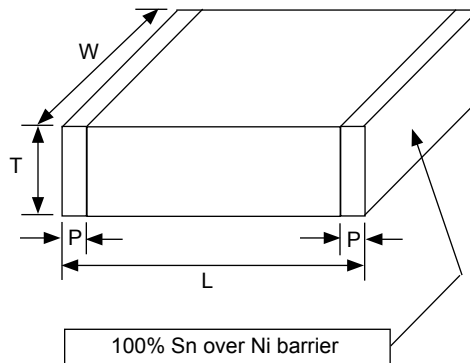

PART NUMBER SYSTEM

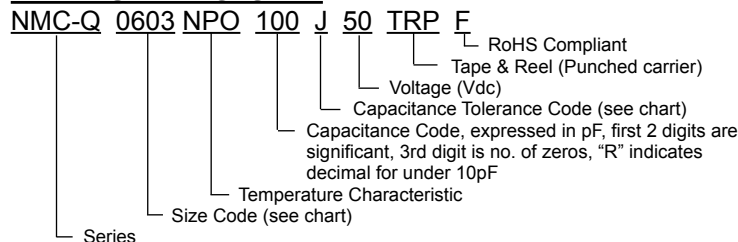

0201 25 Volt Standard Values and Characteristics

NIC PART NUMBER	CAPACITANCE VALUE (pF)	AVAILABLE TOLERANCE	Q FACTOR (typ. @ 1GHz)*	ESR Ω (typ. @ 1GHz)*
NMC-Q0201NPO0R1_6.3TRPF	0.1	B	400	2.2
NMC-Q0201NPO0R2_6.3TRPF	0.2	A, B	400	1.8
NMC-Q0201NPO0R3_6.3TRPF	0.3	A, B	400	0.95
NMC-Q0201NPO0R4_6.3TRPF	0.4	A, B	400	0.75
NMC-Q0201NPO0R5_6.3TRPF	0.5	A, B, C	400	0.50
NMC-Q0201NPO0R6_6.3TRPF	0.6	A, B, C	400	0.45
NMC-Q0201NPO0R7_6.3TRPF	0.7	A, B, C	400	0.40
NMC-Q0201NPO0R8_6.3TRPF	0.8	A, B, C	400	0.40
NMC-Q0201NPO0R9_6.3TRPF	0.9	A, B, C	400	0.35
NMC-Q0201NPO1R0_6.3TRPF	1.0	A, B, C	400	0.35
NMC-Q0201NPO1R1_6.3TRPF	1.1	A, B, C	400	0.35
NMC-Q0201NPO1R2_6.3TRPF	1.2	A, B, C	400	0.35
NMC-Q0201NPO1R3_6.3TRPF	1.3	A, B, C	400	0.35
NMC-Q0201NPO1R4_6.3TRPF	1.4	A, B, C	400	0.35
NMC-Q0201NPO1R5_6.3TRPF	1.5	A, B, C	400	0.30
NMC-Q0201NPO1R6_6.3TRPF	1.6	A, B, C	400	0.30
NMC-Q0201NPO1R7_6.3TRPF	1.7	A, B, C	400	0.30
NMC-Q0201NPO1R8_6.3TRPF	1.8	A, B, C	400	0.30
NMC-Q0201NPO1R9_6.3TRPF	1.9	A, B, C	400	0.30
NMC-Q0201NPO2R0_6.3TRPF	2.0	A, B, C	400	0.30
NMC-Q0201NPO2R1_6.3TRPF	2.1	A, B, C	400	0.30
NMC-Q0201NPO2R2_6.3TRPF	2.2	A, B, C	400	0.25
NMC-Q0201NPO2R3_6.3TRPF	2.3	A, B, C	400	0.25
NMC-Q0201NPO2R4_6.3TRPF	2.4	A, B, C	400	0.25
NMC-Q0201NPO2R5_6.3TRPF	2.5	A, B, C	400	0.25
NMC-Q0201NPO2R6_6.3TRPF	2.6	A, B, C	400	0.25
NMC-Q0201NPO2R7_6.3TRPF	2.7	A, B, C	400	0.25
NMC-Q0201NPO2R8_6.3TRPF	2.8	A, B, C	400	0.25
NMC-Q0201NPO2R9_6.3TRPF	2.9	A, B, C	400	0.25
NMC-Q0201NPO3R0_6.3TRPF	3.0	A, B, C	400	0.25
NMC-Q0201NPO3R1_6.3TRPF	3.1	A, B, C	400	0.25
NMC-Q0201NPO3R2_6.3TRPF	3.2	A, B, C	400	0.25
NMC-Q0201NPO3R3_6.3TRPF	3.3	A, B, C	400	0.25
NMC-Q0201NPO3R4_6.3TRPF	3.4	A, B, C	400	0.25
NMC-Q0201NPO3R5_6.3TRPF	3.5	A, B, C	400	0.25
NMC-Q0201NPO3R6_6.3TRPF	3.6	A, B, C	400	0.25
NMC-Q0201NPO3R7_6.3TRPF	3.7	A, B, C	400	0.25
NMC-Q0201NPO3R8_6.3TRPF	3.8	A, B, C	400	0.25
NMC-Q0201NPO3R9_6.3TRPF	3.9	A, B, C	400	0.20
NMC-Q0201NPO4R0_6.3TRPF	4.0	A, B, C	400	0.20
NMC-Q0201NPO4R1_6.3TRPF	4.1	A, B, C	400	0.20
NMC-Q0201NPO4R2_6.3TRPF	4.2	A, B, C	400	0.20
NMC-Q0201NPO4R3_6.3TRPF	4.3	A, B, C	400	0.20
NMC-Q0201NPO4R4_6.3TRPF	4.4	A, B, C	400	0.20
NMC-Q0201NPO4R5_6.3TRPF	4.5	A, B, C	400	0.20
NMC-Q0201NPO4R6_6.3TRPF	4.6	A, B, C	400	0.20
NMC-Q0201NPO4R7_6.3TRPF	4.7	A, B, C	400	0.20
NMC-Q0201NPO4R7_6.3TRPF	4.7	A, B, C	400	0.20
NMC-Q0201NPO4R8_6.3TRPF	4.8	A, B, C	400	0.20
NMC-Q0201NPO4R9_6.3TRPF	4.9	A, B, C	400	0.20
NMC-Q0201NPO5R1_6.3TRPF	5.1	A, B, C	400	0.20

*Typical Q & ESR

®

0201 25 Volt Standard Values and Characteristics

NIC PART NUMBER	CAPACITANCE VALUE (pF)	AVAILABLE TOLERANCE	Q FACTOR (typ. @ 1GHz)*	ESR Ω (typ. @ 1GHz)*
NMC-Q0201NPO5R2_6.3TRPF	5.2	A, B, C	400	0.20
NMC-Q0201NPO5R3_6.3TRPF	5.3	A, B, C	400	0.20
NMC-Q0201NPO5R4_6.3TRPF	5.4	A, B, C	400	0.20
NMC-Q0201NPO5R6_6.3TRPF	5.6	B, C, D	350	0.15
NMC-Q0201NPO5R7_6.3TRPF	5.7	B, C, D	350	0.15
NMC-Q0201NPO5R9_6.3TRPF	5.9	B, C, D	350	0.15
NMC-Q0201NPO6R0_6.3TRPF	6.0	B, C, D	350	0.15
NMC-Q0201NPO6R1_6.3TRPF	6.1	B, C, D	350	0.15
NMC-Q0201NPO6R2_6.3TRPF	6.2	B, C, D	350	0.15
NMC-Q0201NPO6R3_6.3TRPF	6.3	B, C, D	350	0.15
NMC-Q0201NPO6R4_6.3TRPF	6.4	B, C, D	350	0.15
NMC-Q0201NPO6R6_6.3TRPF	6.6	B, C, D	350	0.15
NMC-Q0201NPO6R8_6.3TRPF	6.8	B, C, D	350	0.15
NMC-Q0201NPO6R9_6.3TRPF	6.9	B, C, D	350	0.15
NMC-Q0201NPO7R0_6.3TRPF	7.0	B, C, D	350	0.15
NMC-Q0201NPO7R1_6.3TRPF	7.1	B, C, D	350	0.15
NMC-Q0201NPO7.2_6.3TRPF	7.2	B, C, D	350	0.15
NMC-Q0201NPO7R3_6.3TRPF	7.3	B, C, D	350	0.15
NMC-Q0201NPO7R4_6.3TRPF	7.4	B, C, D	350	0.15
NMC-Q0201NPO7R5_6.3TRPF	7.5	B, C, D	350	0.15
NMC-Q0201NPO7R6_6.3TRPF	7.6	B, C, D	350	0.15
NMC-Q0201NPO7R7_6.3TRPF	7.7	B, C, D	350	0.15
NMC-Q0201NPO7R8_6.3TRPF	7.8	B, C, D	350	0.15
NMC-Q0201NPO8R0_6.3TRPF	8.0	B, C, D	350	0.15
NMC-Q0201NPO8R1_6.3TRPF	8.1	B, C, D	300	0.15
NMC-Q0201NPO8R2_6.3TRPF	8.2	B, C, D	300	0.15
NMC-Q0201NPO8R3_6.3TRPF	8.3	B, C, D	300	0.15
NMC-Q0201NPO8R4_6.3TRPF	8.4	B, C, D	300	0.15
NMC-Q0201NPO8R5_6.3TRPF	8.5	B, C, D	300	0.15
NMC-Q0201NPO8R6_6.3TRPF	8.6	B, C, D	300	0.15
NMC-Q0201NPO8R7_6.3TRPF	8.7	B, C, D	300	0.15
NMC-Q0201NPO8R8_6.3TRPF	8.8	B, C, D	300	0.15
NMC-Q0201NPO8R9_6.3TRPF	8.9	B, C, D	300	0.15
NMC-Q0201NPO9R0_6.3TRPF	9.0	B, C, D	300	0.15
NMC-Q0201NPO9R1_6.3TRPF	9.1	B, C, D	300	0.15
NMC-Q0201NPO9R2_6.3TRPF	9.2	B, C, D	300	0.15
NMC-Q0201NPO9R3_6.3TRPF	9.3	B, C, D	300	0.15
NMC-Q0201NPO9R4_6.3TRPF	9.4	B, C, D	300	0.15
NMC-Q0201NPO9R5_6.3TRPF	9.5	B, C, D	300	0.15
NMC-Q0201NPO9R6_6.3TRPF	9.6	B, C, D	300	0.15
NMC-Q0201NPO9R7_6.3TRPF	9.7	B, C, D	300	0.15
NMC-Q0201NPO9R8_6.3TRPF	9.8	B, C, D	300	0.15
NMC-Q0201NPO9R9_6.3TRPF	9.9	B, C, D	300	0.15
NMC-Q0201NPO100_6.3TRPF	10	F, G, J	300	0.10
NMC-Q0201NPO110_6.3TRPF	11	F, G, J	300	0.10
NMC-Q0201NPO120_6.3TRPF	12	F, G, J	300	0.10
NMC-Q0201NPO130_6.3TRPF	13	F, G, J	300	0.10
NMC-Q0201NPO150_6.3TRPF	15	F, G, J	250	0.10
NMC-Q0201NPO160_6.3TRPF	16	F, G, J	300	0.10
NMC-Q0201NPO180_6.3TRPF	18	F, G, J	250	0.10
NMC-Q0201NPO200_6.3TRPF	20	F, G, J	250	0.10
NMC-Q0201NPO220_6.3TRPF	22	F, G, J	250	0.10

*Typical Q & ESR

®

0201 25 Volt Standard Values and Characteristics

NIC PART NUMBER	CAPACITANCE VALUE (pF)	AVAILABLE TOLERANCE	Q FACTOR (typ. @ 1GHz)*	ESR Ω (typ. @ 1GHz)*
NMC-Q0201NPO240_6.3TRPF	24	F, G, J	250	0.10
NMC-Q0201NPO270_6.3TRPF	27	F, G, J	250	0.10
NMC-Q0201NPO300_6.3TRPF	30	F, G, J	250	0.10
NMC-Q0201NPO330_6.3TRPF	33	F, G, J	250	0.10

*Typical Q & ESR

0201 25 Volt Standard Values and Characteristics

NIC PART NUMBER	CAPACITANCE VALUE (pF)	AVAILABLE TOLERANCE	Q FACTOR (typ. @ 1GHz)*	ESR Ω (typ. @ 1GHz)*
NMC-Q0201NPO0R1_10TRPF	0.1	B	400	2.2
NMC-Q0201NPO0R2_10TRPF	0.2	A, B	400	1.8
NMC-Q0201NPO0R3_10TRPF	0.3	A, B	400	0.95
NMC-Q0201NPO0R4_10TRPF	0.4	A, B	400	0.75
NMC-Q0201NPO0R5_10TRPF	0.5	A, B, C	400	0.50
NMC-Q0201NPO0R6_10TRPF	0.6	A, B, C	400	0.45
NMC-Q0201NPO0R7_10TRPF	0.7	A, B, C	400	0.40
NMC-Q0201NPO0R8_10TRPF	0.8	A, B, C	400	0.40
NMC-Q0201NPO0R9_10TRPF	0.9	A, B, C	400	0.35
NMC-Q0201NPO1R0_10TRPF	1.0	A, B, C	400	0.35
NMC-Q0201NPO1R1_10TRPF	1.1	A, B, C	400	0.35
NMC-Q0201NPO1R2_10TRPF	1.2	A, B, C	400	0.35
NMC-Q0201NPO1R3_10TRPF	1.3	A, B, C	400	0.35
NMC-Q0201NPO1R4_10TRPF	1.4	A, B, C	400	0.35
NMC-Q0201NPO1R5_10TRPF	1.5	A, B, C	400	0.30
NMC-Q0201NPO1R6_10TRPF	1.6	A, B, C	400	0.30
NMC-Q0201NPO1R7_10TRPF	1.7	A, B, C	400	0.30
NMC-Q0201NPO1R8_10TRPF	1.8	A, B, C	400	0.30
NMC-Q0201NPO1R9_10TRPF	1.9	A, B, C	400	0.30
NMC-Q0201NPO2R0_10TRPF	2.0	A, B, C	400	0.30
NMC-Q0201NPO2R1_10TRPF	2.1	A, B, C	400	0.30
NMC-Q0201NPO2R2_10TRPF	2.2	A, B, C	400	0.25
NMC-Q0201NPO2R3_10TRPF	2.3	A, B, C	400	0.25
NMC-Q0201NPO2R4_10TRPF	2.4	A, B, C	400	0.25
NMC-Q0201NPO2R5_10TRPF	2.5	A, B, C	400	0.25
NMC-Q0201NPO2R6_10TRPF	2.6	A, B, C	400	0.25
NMC-Q0201NPO2R7_10TRPF	2.7	A, B, C	400	0.25
NMC-Q0201NPO2R8_10TRPF	2.8	A, B, C	400	0.25
NMC-Q0201NPO2R9_10TRPF	2.9	A, B, C	400	0.25
NMC-Q0201NPO3R0_10TRPF	3.0	A, B, C	400	0.25
NMC-Q0201NPO3R1_10TRPF	3.1	A, B, C	400	0.25
NMC-Q0201NPO3R2_10TRPF	3.2	A, B, C	400	0.25
NMC-Q0201NPO3R3_10TRPF	3.3	A, B, C	400	0.25
NMC-Q0201NPO3R4_10TRPF	3.4	A, B, C	400	0.25
NMC-Q0201NPO3R5_10TRPF	3.5	A, B, C	400	0.25
NMC-Q0201NPO3R6_10TRPF	3.6	A, B, C	400	0.25
NMC-Q0201NPO3R7_10TRPF	3.7	A, B, C	400	0.25
NMC-Q0201NPO3R8_10TRPF	3.8	A, B, C	400	0.25
NMC-Q0201NPO3R9_10TRPF	3.9	A, B, C	400	0.20
NMC-Q0201NPO4R0_10TRPF	4.0	A, B, C	400	0.20
NMC-Q0201NPO4R1_10TRPF	4.1	A, B, C	400	0.20
NMC-Q0201NPO4R2_10TRPF	4.2	A, B, C	400	0.20
NMC-Q0201NPO4R3_10TRPF	4.3	A, B, C	400	0.20
NMC-Q0201NPO4R4_10TRPF	4.4	A, B, C	400	0.20
NMC-Q0201NPO4R5_10TRPF	4.5	A, B, C	400	0.20
NMC-Q0201NPO4R6_10TRPF	4.6	A, B, C	400	0.20
NMC-Q0201NPO4R7_10TRPF	4.7	A, B, C	400	0.20
NMC-Q0201NPO4R7_10TRPF	4.7	A, B, C	400	0.20
NMC-Q0201NPO4R8_10TRPF	4.8	A, B, C	400	0.20
NMC-Q0201NPO4R9_10TRPF	4.9	A, B, C	400	0.20
NMC-Q0201NPO5R1_10TRPF	5.1	A, B, C	400	0.20

*Typical Q & ESR

®

0201 25 Volt Standard Values and Characteristics

NIC PART NUMBER	CAPACITANCE VALUE (pF)	AVAILABLE TOLERANCE	Q FACTOR (typ. @ 1GHz)*	ESR Ω (typ. @ 1GHz)*
NMC-Q0201NPO5R2_10TRPF	5.2	A, B, C	400	0.20
NMC-Q0201NPO5R3_10TRPF	5.3	A, B, C	400	0.20
NMC-Q0201NPO5R4_10TRPF	5.4	A, B, C	400	0.20
NMC-Q0201NPO5R6_10TRPF	5.6	B, C, D	350	0.15
NMC-Q0201NPO5R7_10TRPF	5.7	B, C, D	350	0.15
NMC-Q0201NPO5R9_10TRPF	5.9	B, C, D	350	0.15
NMC-Q0201NPO6R0_10TRPF	6.0	B, C, D	350	0.15
NMC-Q0201NPO6R1_10TRPF	6.1	B, C, D	350	0.15
NMC-Q0201NPO6R2_10TRPF	6.2	B, C, D	350	0.15
NMC-Q0201NPO6R3_10TRPF	6.3	B, C, D	350	0.15
NMC-Q0201NPO6R4_10TRPF	6.4	B, C, D	350	0.15
NMC-Q0201NPO6R6_10TRPF	6.6	B, C, D	350	0.15
NMC-Q0201NPO6R8_10TRPF	6.8	B, C, D	350	0.15
NMC-Q0201NPO6R9_10TRPF	6.9	B, C, D	350	0.15
NMC-Q0201NPO7R0_10TRPF	7.0	B, C, D	350	0.15
NMC-Q0201NPO7R1_10TRPF	7.1	B, C, D	350	0.15
NMC-Q0201NPO7.2_10TRPF	7.2	B, C, D	350	0.15
NMC-Q0201NPO7R3_10TRPF	7.3	B, C, D	350	0.15
NMC-Q0201NPO7R4_10TRPF	7.4	B, C, D	350	0.15
NMC-Q0201NPO7R5_10TRPF	7.5	B, C, D	350	0.15
NMC-Q0201NPO7R6_10TRPF	7.6	B, C, D	350	0.15
NMC-Q0201NPO7R7_10TRPF	7.7	B, C, D	350	0.15
NMC-Q0201NPO7R8_10TRPF	7.8	B, C, D	350	0.15
NMC-Q0201NPO8R0_10TRPF	8.0	B, C, D	350	0.15
NMC-Q0201NPO8R1_10TRPF	8.1	B, C, D	300	0.15
NMC-Q0201NPO8R2_10TRPF	8.2	B, C, D	300	0.15
NMC-Q0201NPO8R3_10TRPF	8.3	B, C, D	300	0.15
NMC-Q0201NPO8R4_10TRPF	8.4	B, C, D	300	0.15
NMC-Q0201NPO8R5_10TRPF	8.5	B, C, D	300	0.15
NMC-Q0201NPO8R6_10TRPF	8.6	B, C, D	300	0.15
NMC-Q0201NPO8R7_10TRPF	8.7	B, C, D	300	0.15
NMC-Q0201NPO8R8_10TRPF	8.8	B, C, D	300	0.15
NMC-Q0201NPO8R9_10TRPF	8.9	B, C, D	300	0.15
NMC-Q0201NPO9R0_10TRPF	9.0	B, C, D	300	0.15
NMC-Q0201NPO9R1_10TRPF	9.1	B, C, D	300	0.15
NMC-Q0201NPO9R2_10TRPF	9.2	B, C, D	300	0.15
NMC-Q0201NPO9R3_10TRPF	9.3	B, C, D	300	0.15
NMC-Q0201NPO9R4_10TRPF	9.4	B, C, D	300	0.15
NMC-Q0201NPO9R5_10TRPF	9.5	B, C, D	300	0.15
NMC-Q0201NPO9R6_10TRPF	9.6	B, C, D	300	0.15
NMC-Q0201NPO9R7_10TRPF	9.7	B, C, D	300	0.15
NMC-Q0201NPO9R8_10TRPF	9.8	B, C, D	300	0.15
NMC-Q0201NPO9R9_10TRPF	9.9	B, C, D	300	0.15
NMC-Q0201NPO100_10TRPF	10	F, G, J	300	0.10
NMC-Q0201NPO110_10TRPF	11	F, G, J	300	0.10
NMC-Q0201NPO120_10TRPF	12	F, G, J	300	0.10
NMC-Q0201NPO130_10TRPF	13	F, G, J	300	0.10
NMC-Q0201NPO150_10TRPF	15	F, G, J	250	0.10
NMC-Q0201NPO160_10TRPF	16	F, G, J	300	0.10
NMC-Q0201NPO180_10TRPF	18	F, G, J	250	0.10
NMC-Q0201NPO200_10TRPF	20	F, G, J	250	0.10
NMC-Q0201NPO220_10TRPF	22	F, G, J	250	0.10

*Typical Q & ESR

®

0201 25 Volt Standard Values and Characteristics

NIC PART NUMBER	CAPACITANCE VALUE (pF)	AVAILABLE TOLERANCE	Q FACTOR (typ. @ 1GHz)*	ESR Ω (typ. @ 1GHz)*
NMC-Q0201NPO240_10TRPF	24	F, G, J	250	0.10
NMC-Q0201NPO270_10TRPF	27	F, G, J	250	0.10
NMC-Q0201NPO300_10TRPF	30	F, G, J	250	0.10
NMC-Q0201NPO330_10TRPF	33	F, G, J	250	0.10

*Typical Q & ESR

0201 25 Volt Standard Values and Characteristics

NIC PART NUMBER	CAPACITANCE VALUE (pF)	AVAILABLE TOLERANCE	Q FACTOR (typ. @ 1GHz)*	ESR Ω (typ. @ 1GHz)*
NMC-Q0201NPO0R1_25TRPF	0.1	B	400	2.2
NMC-Q0201NPO0R2_25TRPF	0.2	A, B	400	1.8
NMC-Q0201NPO0R3_25TRPF	0.3	A, B	400	0.95
NMC-Q0201NPO0R4_25TRPF	0.4	A, B	400	0.75
NMC-Q0201NPO0R5_25TRPF	0.5	A, B, C	400	0.50
NMC-Q0201NPO0R6_25TRPF	0.6	A, B, C	400	0.45
NMC-Q0201NPO0R7_25TRPF	0.7	A, B, C	400	0.40
NMC-Q0201NPO0R8_25TRPF	0.8	A, B, C	400	0.40
NMC-Q0201NPO0R9_25TRPF	0.9	A, B, C	400	0.35
NMC-Q0201NPO1R0_25TRPF	1.0	A, B, C	400	0.35
NMC-Q0201NPO1R1_25TRPF	1.1	A, B, C	400	0.35
NMC-Q0201NPO1R2_25TRPF	1.2	A, B, C	400	0.35
NMC-Q0201NPO1R3_25TRPF	1.3	A, B, C	400	0.35
NMC-Q0201NPO1R4_25TRPF	1.4	A, B, C	400	0.35
NMC-Q0201NPO1R5_25TRPF	1.5	A, B, C	400	0.30
NMC-Q0201NPO1R6_25TRPF	1.6	A, B, C	400	0.30
NMC-Q0201NPO1R7_25TRPF	1.7	A, B, C	400	0.30
NMC-Q0201NPO1R8_25TRPF	1.8	A, B, C	400	0.30
NMC-Q0201NPO1R9_25TRPF	1.9	A, B, C	400	0.30
NMC-Q0201NPO2R0_25TRPF	2.0	A, B, C	400	0.30
NMC-Q0201NPO2R1_25TRPF	2.1	A, B, C	400	0.30
NMC-Q0201NPO2R2_25TRPF	2.2	A, B, C	400	0.25
NMC-Q0201NPO2R3_25TRPF	2.3	A, B, C	400	0.25
NMC-Q0201NPO2R4_25TRPF	2.4	A, B, C	400	0.25
NMC-Q0201NPO2R5_25TRPF	2.5	A, B, C	400	0.25
NMC-Q0201NPO2R6_25TRPF	2.6	A, B, C	400	0.25
NMC-Q0201NPO2R7_25TRPF	2.7	A, B, C	400	0.25
NMC-Q0201NPO2R8_25TRPF	2.8	A, B, C	400	0.25
NMC-Q0201NPO2R9_25TRPF	2.9	A, B, C	400	0.25
NMC-Q0201NPO3R0_25TRPF	3.0	A, B, C	400	0.25
NMC-Q0201NPO3R1_25TRPF	3.1	A, B, C	400	0.25
NMC-Q0201NPO3R2_25TRPF	3.2	A, B, C	400	0.25
NMC-Q0201NPO3R3_25TRPF	3.3	A, B, C	400	0.25
NMC-Q0201NPO3R4_25TRPF	3.4	A, B, C	400	0.25
NMC-Q0201NPO3R5_25TRPF	3.5	A, B, C	400	0.25
NMC-Q0201NPO3R6_25TRPF	3.6	A, B, C	400	0.25
NMC-Q0201NPO3R7_25TRPF	3.7	A, B, C	400	0.25
NMC-Q0201NPO3R8_25TRPF	3.8	A, B, C	400	0.25
NMC-Q0201NPO3R9_25TRPF	3.9	A, B, C	400	0.20
NMC-Q0201NPO4R0_25TRPF	4.0	A, B, C	400	0.20
NMC-Q0201NPO4R1_25TRPF	4.1	A, B, C	400	0.20
NMC-Q0201NPO4R2_25TRPF	4.2	A, B, C	400	0.20
NMC-Q0201NPO4R3_25TRPF	4.3	A, B, C	400	0.20
NMC-Q0201NPO4R4_25TRPF	4.4	A, B, C	400	0.20
NMC-Q0201NPO4R5_25TRPF	4.5	A, B, C	400	0.20
NMC-Q0201NPO4R6_25TRPF	4.6	A, B, C	400	0.20
NMC-Q0201NPO4R7_25TRPF	4.7	A, B, C	400	0.20
NMC-Q0201NPO4R7_25TRPF	4.7	A, B, C	400	0.20
NMC-Q0201NPO4R8_25TRPF	4.8	A, B, C	400	0.20
NMC-Q0201NPO4R9_25TRPF	4.9	A, B, C	400	0.20
NMC-Q0201NPO5R1_25TRPF	5.1	A, B, C	400	0.20

*Typical Q & ESR

®

0201 25 Volt Standard Values and Characteristics

NIC PART NUMBER	CAPACITANCE VALUE (pF)	AVAILABLE TOLERANCE	Q FACTOR (typ. @ 1GHz)*	ESR Ω (typ. @ 1GHz)*
NMC-Q0201NPO5R2_25TRPF	5.2	A, B, C	400	0.20
NMC-Q0201NPO5R3_25TRPF	5.3	A, B, C	400	0.20
NMC-Q0201NPO5R4_25TRPF	5.4	A, B, C	400	0.20
NMC-Q0201NPO5R6_25TRPF	5.6	B, C, D	350	0.15
NMC-Q0201NPO5R7_25TRPF	5.7	B, C, D	350	0.15
NMC-Q0201NPO5R9_25TRPF	5.9	B, C, D	350	0.15
NMC-Q0201NPO6R0_25TRPF	6.0	B, C, D	350	0.15
NMC-Q0201NPO6R1_25TRPF	6.1	B, C, D	350	0.15
NMC-Q0201NPO6R2_25TRPF	6.2	B, C, D	350	0.15
NMC-Q0201NPO6R3_25TRPF	6.3	B, C, D	350	0.15
NMC-Q0201NPO6R4_25TRPF	6.4	B, C, D	350	0.15
NMC-Q0201NPO6R6_25TRPF	6.6	B, C, D	350	0.15
NMC-Q0201NPO6R8_25TRPF	6.8	B, C, D	350	0.15
NMC-Q0201NPO6R9_25TRPF	6.9	B, C, D	350	0.15
NMC-Q0201NPO7R0_25TRPF	7.0	B, C, D	350	0.15
NMC-Q0201NPO7R1_25TRPF	7.1	B, C, D	350	0.15
NMC-Q0201NPO7R2_25TRPF	7.2	B, C, D	350	0.15
NMC-Q0201NPO7R3_25TRPF	7.3	B, C, D	350	0.15
NMC-Q0201NPO7R4_25TRPF	7.4	B, C, D	350	0.15
NMC-Q0201NPO7R5_25TRPF	7.5	B, C, D	350	0.15
NMC-Q0201NPO7R6_25TRPF	7.6	B, C, D	350	0.15
NMC-Q0201NPO7R7_25TRPF	7.7	B, C, D	350	0.15
NMC-Q0201NPO7R8_25TRPF	7.8	B, C, D	350	0.15
NMC-Q0201NPO8R0_25TRPF	8.0	B, C, D	350	0.15
NMC-Q0201NPO8R1_25TRPF	8.1	B, C, D	300	0.15
NMC-Q0201NPO8R2_25TRPF	8.2	B, C, D	300	0.15
NMC-Q0201NPO8R3_25TRPF	8.3	B, C, D	300	0.15
NMC-Q0201NPO8R4_25TRPF	8.4	B, C, D	300	0.15
NMC-Q0201NPO8R5_25TRPF	8.5	B, C, D	300	0.15
NMC-Q0201NPO8R6_25TRPF	8.6	B, C, D	300	0.15
NMC-Q0201NPO8R7_25TRPF	8.7	B, C, D	300	0.15
NMC-Q0201NPO8R8_25TRPF	8.8	B, C, D	300	0.15
NMC-Q0201NPO8R9_25TRPF	8.9	B, C, D	300	0.15
NMC-Q0201NPO9R0_25TRPF	9.0	B, C, D	300	0.15
NMC-Q0201NPO9R1_25TRPF	9.1	B, C, D	300	0.15
NMC-Q0201NPO9R2_25TRPF	9.2	B, C, D	300	0.15
NMC-Q0201NPO9R3_25TRPF	9.3	B, C, D	300	0.15
NMC-Q0201NPO9R4_25TRPF	9.4	B, C, D	300	0.15
NMC-Q0201NPO9R5_25TRPF	9.5	B, C, D	300	0.15
NMC-Q0201NPO9R6_25TRPF	9.6	B, C, D	300	0.15
NMC-Q0201NPO9R7_25TRPF	9.7	B, C, D	300	0.15
NMC-Q0201NPO9R8_25TRPF	9.8	B, C, D	300	0.15
NMC-Q0201NPO9R9_25TRPF	9.9	B, C, D	300	0.15
NMC-Q0201NPO100_25TRPF	10	F, G, J	300	0.10
NMC-Q0201NPO110_25TRPF	11	F, G, J	300	0.10
NMC-Q0201NPO120_25TRPF	12	F, G, J	300	0.10
NMC-Q0201NPO130_25TRPF	13	F, G, J	300	0.10
NMC-Q0201NPO150_25TRPF	15	F, G, J	250	0.10
NMC-Q0201NPO160_25TRPF	16	F, G, J	300	0.10
NMC-Q0201NPO180_25TRPF	18	F, G, J	250	0.10
NMC-Q0201NPO200_25TRPF	20	F, G, J	250	0.10
NMC-Q0201NPO220_25TRPF	22	F, G, J	250	0.10

*Typical Q & ESR

®

0201 25 Volt Standard Values and Characteristics

NIC PART NUMBER	CAPACITANCE VALUE (pF)	AVAILABLE TOLERANCE	Q FACTOR (typ. @ 1GHz)*	ESR Ω (typ. @ 1GHz)*
NMC-Q0201NPO240_25TRPF	24	F, G, J	250	0.10
NMC-Q0201NPO270_25TRPF	27	F, G, J	250	0.10
NMC-Q0201NPO300_25TRPF	30	F, G, J	250	0.10
NMC-Q0201NPO330_25TRPF	33	F, G, J	250	0.10

*Typical Q & ESR

0201 50 Volt Standard Values and Characteristics

NIC PART NUMBER	CAPACITANCE VALUE (pF)	AVAILABLE TOLERANCE	Q FACTOR (typ. @ 1GHz)*	ESR Ω (typ. @ 1GHz)*
NMC-Q0201NPO0R1_50TRPF	0.1	B	400	2.2
NMC-Q0201NPO0R2_50TRPF	0.2	A, B	400	1.8
NMC-Q0201NPO0R3_50TRPF	0.3	A, B	400	0.95
NMC-Q0201NPO0R4_50TRPF	0.4	A, B	400	0.75
NMC-Q0201NPO0R5_50TRPF	0.5	A, B, C	400	0.50
NMC-Q0201NPO0R6_50TRPF	0.6	A, B, C	400	0.45
NMC-Q0201NPO0R7_50TRPF	0.7	A, B, C	400	0.40
NMC-Q0201NPO0R8_50TRPF	0.8	A, B, C	400	0.40
NMC-Q0201NPO0R9_50TRPF	0.9	A, B, C	400	0.35
NMC-Q0201NPO1R0_50TRPF	1.0	A, B, C	400	0.35
NMC-Q0201NPO1R1_50TRPF	1.1	A, B, C	400	0.35
NMC-Q0201NPO1R2_50TRPF	1.2	A, B, C	400	0.35
NMC-Q0201NPO1R3_50TRPF	1.3	A, B, C	400	0.35
NMC-Q0201NPO1R4_50TRPF	1.4	A, B, C	400	0.35
NMC-Q0201NPO1R5_50TRPF	1.5	A, B, C	400	0.30
NMC-Q0201NPO1R6_50TRPF	1.6	A, B, C	400	0.30
NMC-Q0201NPO1R7_50TRPF	1.7	A, B, C	400	0.30
NMC-Q0201NPO1R8_50TRPF	1.8	A, B, C	400	0.30
NMC-Q0201NPO1R9_50TRPF	1.9	A, B, C	400	0.30
NMC-Q0201NPO2R0_50TRPF	2.0	A, B, C	400	0.30
NMC-Q0201NPO2R1_50TRPF	2.1	A, B, C	400	0.30
NMC-Q0201NPO2R2_50TRPF	2.2	A, B, C	400	0.25
NMC-Q0201NPO2R3_50TRPF	2.3	A, B, C	400	0.25
NMC-Q0201NPO2R4_50TRPF	2.4	A, B, C	400	0.25
NMC-Q0201NPO2R5_50TRPF	2.5	A, B, C	400	0.25
NMC-Q0201NPO2R6_50TRPF	2.6	A, B, C	400	0.25
NMC-Q0201NPO2R7_50TRPF	2.7	A, B, C	400	0.25
NMC-Q0201NPO2R8_50TRPF	2.8	A, B, C	400	0.25
NMC-Q0201NPO2R9_50TRPF	2.9	A, B, C	400	0.25
NMC-Q0201NPO3R0_50TRPF	3.0	A, B, C	400	0.25
NMC-Q0201NPO3R1_50TRPF	3.1	A, B, C	400	0.25
NMC-Q0201NPO3R2_50TRPF	3.2	A, B, C	400	0.25
NMC-Q0201NPO3R3_50TRPF	3.3	A, B, C	400	0.25
NMC-Q0201NPO3R4_50TRPF	3.4	A, B, C	400	0.25
NMC-Q0201NPO3R5_50TRPF	3.5	A, B, C	400	0.25
NMC-Q0201NPO3R6_50TRPF	3.6	A, B, C	400	0.25
NMC-Q0201NPO3R7_50TRPF	3.7	A, B, C	400	0.25
NMC-Q0201NPO3R8_50TRPF	3.8	A, B, C	400	0.25
NMC-Q0201NPO3R9_50TRPF	3.9	A, B, C	400	0.20
NMC-Q0201NPO4R0_50TRPF	4.0	A, B, C	400	0.20
NMC-Q0201NPO4R1_50TRPF	4.1	A, B, C	400	0.20
NMC-Q0201NPO4R2_50TRPF	4.2	A, B, C	400	0.20
NMC-Q0201NPO4R3_50TRPF	4.3	A, B, C	400	0.20
NMC-Q0201NPO4R4_50TRPF	4.4	A, B, C	400	0.20
NMC-Q0201NPO4R5_50TRPF	4.5	A, B, C	400	0.20
NMC-Q0201NPO4R6_50TRPF	4.6	A, B, C	400	0.20
NMC-Q0201NPO4R7_50TRPF	4.7	A, B, C	400	0.20
NMC-Q0201NPO4R7_50TRPF	4.7	A, B, C	400	0.20
NMC-Q0201NPO4R8_50TRPF	4.8	A, B, C	400	0.20
NMC-Q0201NPO4R9_50TRPF	4.9	A, B, C	400	0.20
NMC-Q0201NPO5R1_50TRPF	5.1	A, B, C	400	0.20

*Typical Q & ESR

®

0201 50 Volt Standard Values and Characteristics

NIC PART NUMBER	CAPACITANCE VALUE (pF)	AVAILABLE TOLERANCE	Q FACTOR (typ. @ 1GHz)*	ESR Ω (typ. @ 1GHz)*
NMC-Q0201NPO5R2_50TRPF	5.2	A, B, C	400	0.20
NMC-Q0201NPO5R3_50TRPF	5.3	A, B, C	400	0.20
NMC-Q0201NPO5R4_50TRPF	5.4	A, B, C	400	0.20
NMC-Q0201NPO5R6_50TRPF	5.6	B, C, D	350	0.15
NMC-Q0201NPO5R7_50TRPF	5.7	B, C, D	350	0.15
NMC-Q0201NPO5R9_50TRPF	5.9	B, C, D	350	0.15
NMC-Q0201NPO6R0_50TRPF	6.0	B, C, D	350	0.15
NMC-Q0201NPO6R1_50TRPF	6.1	B, C, D	350	0.15
NMC-Q0201NPO6R2_50TRPF	6.2	B, C, D	350	0.15
NMC-Q0201NPO6R3_50TRPF	6.3	B, C, D	350	0.15
NMC-Q0201NPO6R4_50TRPF	6.4	B, C, D	350	0.15
NMC-Q0201NPO6R6_50TRPF	6.6	B, C, D	350	0.15
NMC-Q0201NPO6R8_50TRPF	6.8	B, C, D	350	0.15
NMC-Q0201NPO6R9_50TRPF	6.9	B, C, D	350	0.15
NMC-Q0201NPO7R0_50TRPF	7.0	B, C, D	350	0.15
NMC-Q0201NPO7R1_50TRPF	7.1	B, C, D	350	0.15
NMC-Q0201NPO7R2_50TRPF	7.2	B, C, D	350	0.15
NMC-Q0201NPO7R3_50TRPF	7.3	B, C, D	350	0.15
NMC-Q0201NPO7R4_50TRPF	7.4	B, C, D	350	0.15
NMC-Q0201NPO7R5_50TRPF	7.5	B, C, D	350	0.15
NMC-Q0201NPO7R6_50TRPF	7.6	B, C, D	350	0.15
NMC-Q0201NPO7R7_50TRPF	7.7	B, C, D	350	0.15
NMC-Q0201NPO7R8_50TRPF	7.8	B, C, D	350	0.15
NMC-Q0201NPO8R0_50TRPF	8.0	B, C, D	350	0.15
NMC-Q0201NPO8R1_50TRPF	8.1	B, C, D	300	0.15
NMC-Q0201NPO8R2_50TRPF	8.2	B, C, D	300	0.15
NMC-Q0201NPO8R3_50TRPF	8.3	B, C, D	300	0.15
NMC-Q0201NPO8R4_50TRPF	8.4	B, C, D	300	0.15
NMC-Q0201NPO8R5_50TRPF	8.5	B, C, D	300	0.15
NMC-Q0201NPO8R6_50TRPF	8.6	B, C, D	300	0.15
NMC-Q0201NPO8R7_50TRPF	8.7	B, C, D	300	0.15
NMC-Q0201NPO8R8_50TRPF	8.8	B, C, D	300	0.15
NMC-Q0201NPO8R9_50TRPF	8.9	B, C, D	300	0.15
NMC-Q0201NPO9R0_50TRPF	9.0	B, C, D	300	0.15
NMC-Q0201NPO9R1_50TRPF	9.1	B, C, D	300	0.15
NMC-Q0201NPO9R2_50TRPF	9.2	B, C, D	300	0.15
NMC-Q0201NPO9R3_50TRPF	9.3	B, C, D	300	0.15
NMC-Q0201NPO9R4_50TRPF	9.4	B, C, D	300	0.15
NMC-Q0201NPO9R5_50TRPF	9.5	B, C, D	300	0.15
NMC-Q0201NPO9R6_50TRPF	9.6	B, C, D	300	0.15
NMC-Q0201NPO9R7_50TRPF	9.7	B, C, D	300	0.15
NMC-Q0201NPO9R8_50TRPF	9.8	B, C, D	300	0.15
NMC-Q0201NPO9R9_50TRPF	9.9	B, C, D	300	0.15
NMC-Q0201NPO100_50TRPF	10	F, G, J	300	0.10
NMC-Q0201NPO110_50TRPF	11	F, G, J	300	0.10
NMC-Q0201NPO120_50TRPF	12	F, G, J	300	0.10
NMC-Q0201NPO130_50TRPF	13	F, G, J	300	0.10
NMC-Q0201NPO150_50TRPF	15	F, G, J	250	0.10
NMC-Q0201NPO160_50TRPF	16	F, G, J	300	0.10
NMC-Q0201NPO180_50TRPF	18	F, G, J	250	0.10
NMC-Q0201NPO200_50TRPF	20	F, G, J	250	0.10
NMC-Q0201NPO220_50TRPF	22	F, G, J	250	0.10

*Typical Q & ESR

®

0402 25 Volt Standard Values and Characteristics

NIC PART NUMBER	CAPACITANCE VALUE (pF)	AVAILABLE TOLERANCE	Q FACTOR (typ. @ 1GHz)*	ESR Ω (typ. @ 1GHz)*
NMC-Q0402NPO0R1_25TRPF	0.1	B	400	2.50
NMC-Q0402NPO0R2_25TRPF	0.2	A, B	400	1.60
NMC-Q0402NPO0R3_25TRPF	0.3	A, B	400	1.10
NMC-Q0402NPO0R4_25TRPF	0.4	A, B	400	0.80
NMC-Q0402NPO0R5_25TRPF	0.5	A, B, C	400	0.50
NMC-Q0402NPO0R6_25TRPF	0.6	A, B, C	400	0.40
NMC-Q0402NPO0R7_25TRPF	0.7	A, B, C	400	0.30
NMC-Q0402NPO0R8_25TRPF	0.8	A, B, C	400	0.25
NMC-Q0402NPO0R9_25TRPF	0.9	A, B, C	400	0.20
NMC-Q0402NPO1R0_25TRPF	1.0	A, B, C	400	0.20
NMC-Q0402NPO1R2_25TRPF	1.2	A, B, C	400	0.20
NMC-Q0402NPO1R5_25TRPF	1.5	A, B, C	400	0.20
NMC-Q0402NPO1R6_25TRPF	1.6	A, B, C	400	0.20
NMC-Q0402NPO1R7_25TRPF	1.7	A, B, C	400	0.20
NMC-Q0402NPO1R8_25TRPF	1.8	A, B, C	400	0.20
NMC-Q0402NPO1R9_25TRPF	1.9	A, B, C	400	0.20
NMC-Q0402NPO2R0_25TRPF	2.0	A, B, C	400	0.20
NMC-Q0402NPO2R1_25TRPF	2.1	A, B, C	400	0.20
NMC-Q0402NPO2R2_25TRPF	2.2	A, B, C	400	0.20
NMC-Q0402NPO2R3_25TRPF	2.3	A, B, C	400	0.20
NMC-Q0402NPO2R4_25TRPF	2.4	A, B, C	400	0.20
NMC-Q0402NPO2R7_25TRPF	2.7	A, B, C	400	0.20
NMC-Q0402NPO3R3_25TRPF	3.3	A, B, C	400	0.15
NMC-Q0402NPO3R6_25TRPF	3.6	A, B, C	400	0.15
NMC-Q0402NPO3R9_25TRPF	3.9	A, B, C	350	0.15
NMC-Q0402NPO4R7_25TRPF	4.7	A, B, C	300	0.15
NMC-Q0402NPO5R1_25TRPF	5.1	B, C, D	300	0.15
NMC-Q0402NPO5R6_25TRPF	5.6	B, C, D	300	0.15
NMC-Q0402NPO6R8_25TRPF	6.8	B, C, D	250	0.15
NMC-Q0402NPO8R2_25TRPF	8.2	B, C, D	250	0.10
NMC-Q0402NPO100_25TRPF	10	F, G, J	250	0.10
NMC-Q0402NPO120_25TRPF	12	F, G, J	250	0.10
NMC-Q0402NPO150_25TRPF	15	F, G, J	250	0.10
NMC-Q0402NPO180_25TRPF	18	F, G, J	250	0.10
NMC-Q0402NPO220_25TRPF	22	F, G, J	250	0.10
NMC-Q0402NPO270_25TRPF	27	F, G, J	250	0.10
NMC-Q0402NPO330_25TRPF	33	F, G, J	250	0.10
NMC-Q0402NPO390_25TRPF	39	F, G, J	150	0.10
NMC-Q0402NPO430_25TRPF	43	F, G, J	150	0.10
NMC-Q0402NPO470_25TRPF	47	F, G, J	30	0.10
NMC-Q0402NPO510_25TRPF	51	F, G, J	30	0.10
NMC-Q0402NPO560_25TRPF	56	F, G, J	30	0.10
NMC-Q0402NPO680_25TRPF	68	F, G, J	15	0.10
NMC-Q0402NPO820_25TRPF	82	F, G, J	15	0.10
NMC-Q0402NPO101_25TRPF	100	F, G, J	15	0.10

*Typical Q & ESR

0402 50 Volt Standard Values and Characteristics

NIC PART NUMBER	CAPACITANCE VALUE (pF)	AVAILABLE TOLERANCE	Q FACTOR (typ. @ 1GHz)*	ESR Ω (typ. @ 1GHz)*
NMC-Q0402NPO0R1_50TRPF	0.1	B	400	2.50
NMC-Q0402NPO0R2_50TRPF	0.2	A, B	400	1.60
NMC-Q0402NPO0R3_50TRPF	0.3	A, B	400	1.10
NMC-Q0402NPO0R4_50TRPF	0.4	A, B	400	0.80
NMC-Q0402NPO0R5_50TRPF	0.5	A, B, C	400	0.50
NMC-Q0402NPO0R6_50TRPF	0.6	A, B, C	400	0.40
NMC-Q0402NPO0R7_50TRPF	0.7	A, B, C	400	0.30
NMC-Q0402NPO0R8_50TRPF	0.8	A, B, C	400	0.25
NMC-Q0402NPO0R9_50TRPF	0.9	A, B, C	400	0.20
NMC-Q0402NPO1R0_50TRPF	1.0	A, B, C	400	0.20
NMC-Q0402NPO1R2_50TRPF	1.2	A, B, C	400	0.20
NMC-Q0402NPO1R5_50TRPF	1.5	A, B, C	400	0.20
NMC-Q0402NPO1R6_50TRPF	1.6	A, B, C	400	0.20
NMC-Q0402NPO1R7_50TRPF	1.7	A, B, C	400	0.20
NMC-Q0402NPO1R8_50TRPF	1.8	A, B, C	400	0.20
NMC-Q0402NPO1R9_50TRPF	1.9	A, B, C	400	0.20
NMC-Q0402NPO2R0_50TRPF	2.0	A, B, C	400	0.20
NMC-Q0402NPO2R1_50TRPF	2.1	A, B, C	400	0.20
NMC-Q0402NPO2R2_50TRPF	2.2	A, B, C	400	0.20
NMC-Q0402NPO2R3_50TRPF	2.3	A, B, C	400	0.20
NMC-Q0402NPO2R4_50TRPF	2.4	A, B, C	400	0.20
NMC-Q0402NPO2R7_50TRPF	2.7	A, B, C	400	0.20
NMC-Q0402NPO3R3_50TRPF	3.3	A, B, C	400	0.15
NMC-Q0402NPO3R6_50TRPF	3.6	A, B, C	400	0.15
NMC-Q0402NPO3R9_50TRPF	3.9	A, B, C	350	0.15
NMC-Q0402NPO4R7_50TRPF	4.7	A, B, C	300	0.15
NMC-Q0402NPO5R1_50TRPF	5.1	B, C, D	300	0.15
NMC-Q0402NPO5R6_50TRPF	5.6	B, C, D	300	0.15
NMC-Q0402NPO6R8_50TRPF	6.8	B, C, D	250	0.15
NMC-Q0402NPO8R2_50TRPF	8.2	B, C, D	250	0.10
NMC-Q0402NPO100_50TRPF	10	F, G, J	250	0.10
NMC-Q0402NPO120_50TRPF	12	F, G, J	250	0.10
NMC-Q0402NPO150_50TRPF	15	F, G, J	250	0.10
NMC-Q0402NPO180_50TRPF	18	F, G, J	250	0.10
NMC-Q0402NPO220_50TRPF	22	F, G, J	250	0.10
NMC-Q0402NPO270_50TRPF	27	F, G, J	250	0.10
NMC-Q0402NPO330_50TRPF	33	F, G, J	250	0.10
NMC-Q0402NPO390_50TRPF	39	F, G, J	150	0.10
NMC-Q0402NPO430_50TRPF	43	F, G, J	150	0.10
NMC-Q0402NPO470_50TRPF	47	F, G, J	30	0.10
NMC-Q0402NPO510_50TRPF	51	F, G, J	30	0.10
NMC-Q0402NPO560_50TRPF	56	F, G, J	30	0.10

*Typical Q & ESR

0402 100 Volt Standard Values and Characteristics

NIC PART NUMBER	CAPACITANCE VALUE (pF)	AVAILABLE TOLERANCE	Q FACTOR (typ. @ 1GHz)*	ESR Ω (typ. @ 1GHz)*
NMC-Q0402NPO0R1_100TRPF	0.1	B	400	2.50
NMC-Q0402NPO0R2_100TRPF	0.2	A, B	400	1.60
NMC-Q0402NPO0R3_100TRPF	0.3	A, B	400	1.10
NMC-Q0402NPO0R4_100TRPF	0.4	A, B	400	0.80
NMC-Q0402NPO0R5_100TRPF	0.5	A, B, C	400	0.50
NMC-Q0402NPO0R6_100TRPF	0.6	A, B, C	400	0.40
NMC-Q0402NPO0R7_100TRPF	0.7	A, B, C	400	0.30
NMC-Q0402NPO0R8_100TRPF	0.8	A, B, C	400	0.25
NMC-Q0402NPO0R9_100TRPF	0.9	A, B, C	400	0.20
NMC-Q0402NPO1R0_100TRPF	1.0	A, B, C	400	0.20
NMC-Q0402NPO1R2_100TRPF	1.2	A, B, C	400	0.20
NMC-Q0402NPO1R5_100TRPF	1.5	A, B, C	400	0.20
NMC-Q0402NPO1R6_100TRPF	1.6	A, B, C	400	0.20
NMC-Q0402NPO1R7_100TRPF	1.7	A, B, C	400	0.20
NMC-Q0402NPO1R8_100TRPF	1.8	A, B, C	400	0.20
NMC-Q0402NPO1R9_100TRPF	1.9	A, B, C	400	0.20
NMC-Q0402NPO2R0_100TRPF	2.0	A, B, C	400	0.20
NMC-Q0402NPO2R1_100TRPF	2.1	A, B, C	400	0.20
NMC-Q0402NPO2R2_100TRPF	2.2	A, B, C	400	0.20
NMC-Q0402NPO2R3_100TRPF	2.3	A, B, C	400	0.20
NMC-Q0402NPO2R4_100TRPF	2.4	A, B, C	400	0.20
NMC-Q0402NPO2R7_100TRPF	2.7	A, B, C	400	0.20
NMC-Q0402NPO3R3_100TRPF	3.3	A, B, C	400	0.15
NMC-Q0402NPO3R6_100TRPF	3.6	A, B, C	400	0.15
NMC-Q0402NPO3R9_100TRPF	3.9	A, B, C	350	0.15
NMC-Q0402NPO4R7_100TRPF	4.7	A, B, C	300	0.15
NMC-Q0402NPO5R1_100TRPF	5.1	B, C, D	300	0.15
NMC-Q0402NPO5R6_100TRPF	5.6	B, C, D	300	0.15
NMC-Q0402NPO6R8_100TRPF	6.8	B, C, D	250	0.15
NMC-Q0402NPO8R2_100TRPF	8.2	B, C, D	250	0.10
NMC-Q0402NPO100_100TRPF	10	F, G, J	250	0.10
NMC-Q0402NPO120_100TRPF	12	F, G, J	250	0.10
NMC-Q0402NPO150_100TRPF	15	F, G, J	250	0.10
NMC-Q0402NPO180_100TRPF	18	F, G, J	250	0.10
NMC-Q0402NPO220_100TRPF	22	F, G, J	250	0.10
NMC-Q0402NPO270_100TRPF	27	F, G, J	250	0.10
NMC-Q0402NPO330_100TRPF	33	F, G, J	250	0.10
NMC-Q0402NPO390_100TRPF	39	F, G, J	150	0.10
NMC-Q0402NPO430_100TRPF	43	F, G, J	150	0.10
NMC-Q0402NPO470_100TRPF	47	F, G, J	30	0.10
NMC-Q0402NPO510_100TRPF	51	F, G, J	30	0.10
NMC-Q0402NPO560_100TRPF	56	F, G, J	30	0.10

*Typical Q & ESR

®

0402 200 Volt Standard Values and Characteristics

NIC PART NUMBER	CAPACITANCE VALUE (pF)	AVAILABLE TOLERANCE	Q FACTOR (typ. @ 1GHz)*	ESR Ω (typ. @ 1GHz)*
NMC-Q0402NPO0R1_200TRPF	0.1	B	400	2.50
NMC-Q0402NPO0R2_200TRPF	0.2	A, B	400	1.60
NMC-Q0402NPO0R3_200TRPF	0.3	A, B	400	1.10
NMC-Q0402NPO0R4_200TRPF	0.4	A, B	400	0.80
NMC-Q0402NPO0R5_200TRPF	0.5	A, B, C	400	0.50
NMC-Q0402NPO0R6_200TRPF	0.6	A, B, C	400	0.40
NMC-Q0402NPO0R7_200TRPF	0.7	A, B, C	400	0.30
NMC-Q0402NPO0R8_200TRPF	0.8	A, B, C	400	0.25
NMC-Q0402NPO0R9_200TRPF	0.9	A, B, C	400	0.20
NMC-Q0402NPO1R0_200TRPF	1.0	A, B, C	400	0.20
NMC-Q0402NPO1R2_200TRPF	1.2	A, B, C	400	0.20
NMC-Q0402NPO1R5_200TRPF	1.5	A, B, C	400	0.20
NMC-Q0402NPO1R6_200TRPF	1.6	A, B, C	400	0.20
NMC-Q0402NPO1R7_200TRPF	1.7	A, B, C	400	0.20
NMC-Q0402NPO1R8_200TRPF	1.8	A, B, C	400	0.20
NMC-Q0402NPO1R9_200TRPF	1.9	A, B, C	400	0.20
NMC-Q0402NPO2R0_200TRPF	2.0	A, B, C	400	0.20
NMC-Q0402NPO2R1_200TRPF	2.1	A, B, C	400	0.20
NMC-Q0402NPO2R2_200TRPF	2.2	A, B, C	400	0.20
NMC-Q0402NPO2R3_200TRPF	2.3	A, B, C	400	0.20
NMC-Q0402NPO2R4_200TRPF	2.4	A, B, C	400	0.20
NMC-Q0402NPO2R7_200TRPF	2.7	A, B, C	400	0.20
NMC-Q0402NPO3R3_200TRPF	3.3	A, B, C	400	0.15
NMC-Q0402NPO3R6_200TRPF	3.6	A, B, C	400	0.15
NMC-Q0402NPO3R9_200TRPF	3.9	A, B, C	350	0.15
NMC-Q0402NPO4R7_200TRPF	4.7	A, B, C	300	0.15
NMC-Q0402NPO5R1_200TRPF	5.1	B, C, D	300	0.15
NMC-Q0402NPO5R6_200TRPF	5.6	B, C, D	300	0.15
NMC-Q0402NPO6R8_200TRPF	6.8	B, C, D	250	0.15
NMC-Q0402NPO8R2_200TRPF	8.2	B, C, D	250	0.10
NMC-Q0402NPO100_200TRPF	10	F, G, J	250	0.10
NMC-Q0402NPO120_200TRPF	12	F, G, J	250	0.10
NMC-Q0402NPO150_200TRPF	15	F, G, J	250	0.10
NMC-Q0402NPO180_200TRPF	18	F, G, J	250	0.10
NMC-Q0402NPO220_200TRPF	22	F, G, J	250	0.10
NMC-Q0402NPO270_200TRPF	27	F, G, J	250	0.10
NMC-Q0402NPO330_200TRPF	33	F, G, J	250	0.10

*Typical Q & ESR

0505 250 Volt Standard Values and Characteristics

NIC PART NUMBER	CAPACITANCE VALUE (pF)	AVAILABLE TOLERANCE	Q FACTOR (typ. @ 1GHz)*	ESR Ω (typ. @ 1GHz)*
NMC-Q0505NPO0R4_250TRPF	0.4	A, B, C	800	0.40
NMC-Q0505NPO0R5_250TRPF	0.5	A, B, C	800	0.40
NMC-Q0505NPO0R6_250TRPF	0.6	A, B, C	800	0.40
NMC-Q0505NPO0R7_250TRPF	0.7	A, B, C	700	0.30
NMC-Q0505NPO0R8_250TRPF	0.8	A, B, C	700	0.30
NMC-Q0505NPO0R9_250TRPF	0.9	A, B, C	700	0.30
NMC-Q0505NPO1R0_250TRPF	1.0	A, B, C	700	0.20
NMC-Q0505NPO1R2_250TRPF	1.2	A, B, C	700	0.20
NMC-Q0505NPO1R5_250TRPF	1.5	A, B, C	700	0.20
NMC-Q0505NPO1R8_250TRPF	1.8	A, B, C	700	0.10
NMC-Q0505NPO2R2_250TRPF	2.2	A, B, C	500	0.10
NMC-Q0505NPO2R7_250TRPF	2.7	A, B, C	500	0.10
NMC-Q0505NPO3R3_250TRPF	3.3	A, B, C	500	0.10
NMC-Q0505NPO3R9_250TRPF	3.9	A, B, C	500	0.10
NMC-Q0505NPO4R7_250TRPF	4.7	A, B, C	500	0.10
NMC-Q0505NPO5R6_250TRPF	5.6	B, C, D	400	0.10
NMC-Q0505NPO6R8_250TRPF	6.8	B, C, D	400	0.10
NMC-Q0505NPO8R2_250TRPF	8.2	B, C, D	300	0.10
NMC-Q0505NPO100_250TRPF	10	F, G, J	300	0.10
NMC-Q0505NPO120_250TRPF	12	F, G, J	300	0.10
NMC-Q0505NPO150_250TRPF	15	F, G, J	200	0.10
NMC-Q0505NPO180_250TRPF	18	F, G, J	200	0.10
NMC-Q0505NPO220_250TRPF	22	F, G, J	200	0.10
NMC-Q0505NPO270_250TRPF	27	F, G, J	200	0.10
NMC-Q0505NPO330_250TRPF	33	F, G, J	50	0.10
NMC-Q0505NPO390_250TRPF	39	F, G, J	50	0.10
NMC-Q0505NPO470_250TRPF	47	F, G, J	50	0.10
NMC-Q0505NPO560_250TRPF	56	F, G, J	30	0.10
NMC-Q0505NPO680_250TRPF	68	F, G, J	30	0.10
NMC-Q0505NPO820_250TRPF	82	F, G, J	10	0.10
NMC-Q0505NPO101_250TRPF	100	F, G, J	10	0.10

Contact NIC for values not shown.

*Typical Q & ESR

0603 50 Volt Standard Values and Characteristics

NIC PART NUMBER	CAPACITANCE VALUE (pF)	AVAILABLE TOLERANCE	Q FACTOR (typ. @ 1GHz)*	ESR Ω (typ. @ 1GHz)*
NMC-Q0603NPO0R3_50TRPF	0.3	B	400	0.90
NMC-Q0603NPO0R4_50TRPF	0.4	A, B	400	0.90
NMC-Q0603NPO0R45_50TRPF	0.45	A, B	400	0.90
NMC-Q0603NPO0R5_50TRPF	0.5	A, B, C	400	0.80
NMC-Q0603NPO0R6_50TRPF	0.6	A, B, C	400	0.70
NMC-Q0603NPO0R7_50TRPF	0.7	A, B, C	400	0.50
NMC-Q0603NPO0R8_50TRPF	0.8	A, B, C	400	0.50
NMC-Q0603NPO0R9_50TRPF	0.9	A, B, C	400	0.40
NMC-Q0603NPO1R0_50TRPF	1.0	A, B, C	400	0.30
NMC-Q0603NPO1R2_50TRPF	1.2	A, B, C	400	0.20
NMC-Q0603NPO1R5_50TRPF	1.5	A, B, C	400	0.20
NMC-Q0603NPO1R6_50TRPF	1.6	A, B, C	400	0.20
NMC-Q0603NPO1R8_50TRPF	1.8	A, B, C	400	0.20
NMC-Q0603NPO2R0_50TRPF	2.0	A, B, C	400	0.20
NMC-Q0603NPO2R2_50TRPF	2.2	A, B, C	400	0.20
NMC-Q0603NPO2R7_50TRPF	2.7	A, B, C	400	0.15
NMC-Q0603NPO3R3_50TRPF	3.3	A, B, C	350	0.15
NMC-Q0603NPO3R9_50TRPF	3.9	A, B, C	350	0.10
NMC-Q0603NPO4R3_50TRPF	4.3	A, B, C	300	0.10
NMC-Q0603NPO4R7_50TRPF	4.7	A, B, C	300	0.10
NMC-Q0603NPO5R6_50TRPF	5.6	B, C, D	300	0.10
NMC-Q0603NPO6R8_50TRPF	6.8	B, C, D	250	0.10
NMC-Q0603NPO8R2_50TRPF	8.2	B, C, D	200	0.10
NMC-Q0603NPO100_50TRPF	10	F, G, J	150	0.10
NMC-Q0603NPO120_50TRPF	12	F, G, J	100	0.10
NMC-Q0603NPO150_50TRPF	15	F, G, J	100	0.10
NMC-Q0603NPO180_50TRPF	18	F, G, J	100	0.10
NMC-Q0603NPO220_50TRPF	22	F, G, J	100	0.10
NMC-Q0603NPO270_50TRPF	27	F, G, J	75	0.10
NMC-Q0603NPO330_50TRPF	33	F, G, J	60	0.10
NMC-Q0603NPO390_50TRPF	39	F, G, J	40	0.10
NMC-Q0603NPO430_50TRPF	43	F, G, J	25	0.10
NMC-Q0603NPO470_50TRPF	47	F, G, J	25	0.10
NMC-Q0603NPO560_50TRPF	56	F, G, J	10	0.10
NMC-Q0603NPO680_50TRPF	68	F, G, J	3	0.10
NMC-Q0603NPO820_50TRPF	82	F, G, J	3	0.10
NMC-Q0603NPO101_50TRPF	100	F, G, J	3	0.10

*Typical Q & ESR

0603 100 Volt Standard Values and Characteristics

NIC PART NUMBER	CAPACITANCE VALUE (pF)	AVAILABLE TOLERANCE	Q FACTOR (typ. @ 1GHz)*	ESR Ω (typ. @ 1GHz)*
NMC-Q0603NPO0R3_100TRPF	0.3	B	400	0.90
NMC-Q0603NPO0R4_100TRPF	0.4	A, B	400	0.90
NMC-Q0603NPO0R5_100TRPF	0.5	A, B, C	400	0.80
NMC-Q0603NPO0R6_100TRPF	0.6	A, B, C	400	0.70
NMC-Q0603NPO0R7_100TRPF	0.7	A, B, C	400	0.50
NMC-Q0603NPO0R8_100TRPF	0.8	A, B, C	400	0.50
NMC-Q0603NPO0R9_100TRPF	0.9	A, B, C	400	0.40
NMC-Q0603NPO1R0_100TRPF	1.0	A, B, C	400	0.30
NMC-Q0603NPO1R2_100TRPF	1.2	A, B, C	400	0.20
NMC-Q0603NPO1R5_100TRPF	1.5	A, B, C	400	0.20
NMC-Q0603NPO1R8_100TRPF	1.8	A, B, C	400	0.20
NMC-Q0603NPO2R2_100TRPF	2.2	A, B, C	400	0.20
NMC-Q0603NPO2R7_100TRPF	2.7	A, B, C	400	0.15
NMC-Q0603NPO3R3_100TRPF	3.3	A, B, C	350	0.15
NMC-Q0603NPO3R9_100TRPF	3.9	A, B, C	350	0.10
NMC-Q0603NPO4R7_100TRPF	4.7	A, B, C	300	0.10
NMC-Q0603NPO5R6_100TRPF	5.6	B, C, D	300	0.10
NMC-Q0603NPO6R8_100TRPF	6.8	B, C, D	250	0.10
NMC-Q0603NPO8R2_100TRPF	8.2	B, C, D	200	0.10
NMC-Q0603NPO100_100TRPF	10	F, G, J	150	0.10
NMC-Q0603NPO120_100TRPF	12	F, G, J	100	0.10
NMC-Q0603NPO150_100TRPF	15	F, G, J	100	0.10
NMC-Q0603NPO180_100TRPF	18	F, G, J	100	0.10
NMC-Q0603NPO220_100TRPF	22	F, G, J	100	0.10
NMC-Q0603NPO270_100TRPF	27	F, G, J	75	0.10
NMC-Q0603NPO330_100TRPF	33	F, G, J	60	0.10
NMC-Q0603NPO390_100TRPF	39	F, G, J	40	0.10
NMC-Q0603NPO430_100TRPF	43	F, G, J	25	0.10
NMC-Q0603NPO470_100TRPF	47	F, G, J	25	0.10
NMC-Q0603NPO560_100TRPF	56	F, G, J	10	0.10
NMC-Q0603NPO680_100TRPF	68	F, G, J	3	0.10
NMC-Q0603NPO820_100TRPF	82	F, G, J	3	0.10
NMC-Q0603NPO101_100TRPF	100	F, G, J	3	0.10

*Typical Q & ESR

0603 250 Volt Standard Values and Characteristics

NIC PART NUMBER	CAPACITANCE VALUE (pF)	AVAILABLE TOLERANCE	Q FACTOR (typ. @ 1GHz)*	ESR Ω (@ 1GHz)*
NMC-Q0603NPO0R3_250TRPF	0.3	B	400	0.90
NMC-Q0603NPO0R4_250TRPF	0.4	A, B	400	0.90
NMC-Q0603NPO0R5_250TRPF	0.5	A, B, C	400	0.80
NMC-Q0603NPO0R6_250TRPF	0.6	A, B, C	400	0.70
NMC-Q0603NPO0R7_250TRPF	0.7	A, B, C	400	0.50
NMC-Q0603NPO0R8_250TRPF	0.8	A, B, C	400	0.50
NMC-Q0603NPO0R9_250TRPF	0.9	A, B, C	400	0.40
NMC-Q0603NPO1R0_250TRPF	1.0	A, B, C	400	0.30
NMC-Q0603NPO1R2_250TRPF	1.2	A, B, C	400	0.20
NMC-Q0603NPO1R5_250TRPF	1.5	A, B, C	400	0.20
NMC-Q0603NPO1R8_250TRPF	1.8	A, B, C	400	0.20
NMC-Q0603NPO2R2_250TRPF	2.2	A, B, C	400	0.20
NMC-Q0603NPO2R7_250TRPF	2.7	A, B, C	400	0.15
NMC-Q0603NPO3R3_250TRPF	3.3	A, B, C	350	0.15
NMC-Q0603NPO3R9_250TRPF	3.9	A, B, C	350	0.10
NMC-Q0603NPO4R7_250TRPF	4.7	A, B, C	300	0.10
NMC-Q0603NPO5R6_250TRPF	5.6	B, C, D	300	0.10
NMC-Q0603NPO6R8_250TRPF	6.8	B, C, D	250	0.10
NMC-Q0603NPO8R2_250TRPF	8.2	B, C, D	200	0.10
NMC-Q0603NPO100_250TRPF	10	F, G, J	150	0.10
NMC-Q0603NPO120_250TRPF	12	F, G, J	100	0.10
NMC-Q0603NPO150_250TRPF	15	F, G, J	100	0.10
NMC-Q0603NPO180_250TRPF	18	F, G, J	100	0.10
NMC-Q0603NPO220_250TRPF	22	F, G, J	100	0.10
NMC-Q0603NPO270_250TRPF	27	F, G, J	75	0.10
NMC-Q0603NPO330_250TRPF	33	F, G, J	60	0.10
NMC-Q0603NPO390_250TRPF	39	F, G, J	40	0.10
NMC-Q0603NPO430_250TRPF	43	F, G, J	25	0.10
NMC-Q0603NPO470_250TRPF	47	F, G, J	25	0.10
NMC-Q0603NPO560_250TRPF	56	F, G, J	10	0.10
NMC-Q0603NPO680_250TRPF	68	F, G, J	3	0.10
NMC-Q0603NPO820_250TRPF	82	F, G, J	3	0.10
NMC-Q0603NPO101_250TRPF	100	F, G, J	3	0.10

*Typical Q & ESR

0805 50 Volt Standard Values and Characteristics

NIC PART NUMBER	CAPACITANCE VALUE (pF)	AVAILABLE TOLERANCE	Q FACTOR (typ. @ 1GHz)*	ESR Ω (typ. @ 1GHz)*
NMC-Q0805NPO0R2_50TRPF	0.2	B	400	0.90
NMC-Q0805NPO0R3_50TRPF	0.3	B	400	0.90
NMC-Q0805NPO0R4_50TRPF	0.4	A, B	400	0.90
NMC-Q0805NPO0R5_50TRPF	0.5	A, B, C	400	0.80
NMC-Q0805NPO0R6_50TRPF	0.6	A, B, C	400	0.70
NMC-Q0805NPO0R7_50TRPF	0.7	A, B, C	400	0.50
NMC-Q0805NPO0R8_50TRPF	0.8	A, B, C	400	0.50
NMC-Q0805NPO0R9_50TRPF	0.9	A, B, C	400	0.40
NMC-Q0805NPO1R0_50TRPF	1.0	A, B, C	400	0.30
NMC-Q0805NPO1R2_50TRPF	1.2	A, B, C	400	0.20
NMC-Q0805NPO1R5_50TRPF	1.5	A, B, C	400	0.20
NMC-Q0805NPO1R6_50TRPF	1.6	A, B, C	400	0.20
NMC-Q0805NPO1R8_50TRPF	1.8	A, B, C	400	0.20
NMC-Q0805NPO2R0_50TRPF	2.0	A, B, C	400	0.20
NMC-Q0805NPO2R2_50TRPF	2.2	A, B, C	400	0.20
NMC-Q0805NPO2R7_50TRPF	2.7	A, B, C	400	0.15
NMC-Q0805NPO3R3_50TRPF	3.3	A, B, C	350	0.15
NMC-Q0805NPO3R9_50TRPF	3.9	A, B, C	350	0.10
NMC-Q0805NPO4R3_50TRPF	4.3	A, B, C	300	0.10
NMC-Q0805NPO4R7_50TRPF	4.7	A, B, C	300	0.10
NMC-Q0805NPO5R6_50TRPF	5.6	B, C, D	300	0.10
NMC-Q0805NPO6R8_50TRPF	6.8	B, C, D	250	0.10
NMC-Q0805NPO8R2_50TRPF	8.2	B, C, D	200	0.10
NMC-Q0805NPO100_50TRPF	10	F, G, J	150	0.10
NMC-Q0805NPO120_50TRPF	12	F, G, J	100	0.10
NMC-Q0805NPO150_50TRPF	15	F, G, J	100	0.10
NMC-Q0805NPO180_50TRPF	18	F, G, J	100	0.10
NMC-Q0805NPO220_50TRPF	22	F, G, J	100	0.10
NMC-Q0805NPO270_50TRPF	27	F, G, J	75	0.10
NMC-Q0805NPO330_50TRPF	33	F, G, J	60	0.10
NMC-Q0805NPO390_50TRPF	39	F, G, J	40	0.10
NMC-Q0805NPO430_50TRPF	43	F, G, J	25	0.10
NMC-Q0805NPO470_50TRPF	47	F, G, J	25	0.10
NMC-Q0805NPO560_50TRPF	56	F, G, J	10	0.10
NMC-Q0805NPO680_50TRPF	68	F, G, J	3	0.10
NMC-Q0805NPO820_50TRPF	82	F, G, J	3	0.10
NMC-Q0805NPO101_50TRPF	100	F, G, J	3	0.10

*Typical Q & ESR

0805 100 Volt Standard Values and Characteristics

NIC PART NUMBER	CAPACITANCE VALUE (pF)	AVAILABLE TOLERANCE	Q FACTOR (typ. @ 1GHz)*	ESR Ω (typ. @ 1GHz)*
NMC-Q0805NPO0R2_100TRPF	0.2	B	400	0.90
NMC-Q0805NPO0R3_100TRPF	0.3	B	400	0.90
NMC-Q0805NPO0R4_100TRPF	0.4	A, B	400	0.90
NMC-Q0805NPO0R5_100TRPF	0.5	A, B, C	400	0.80
NMC-Q0805NPO0R6_100TRPF	0.6	A, B, C	400	0.70
NMC-Q0805NPO0R7_100TRPF	0.7	A, B, C	400	0.50
NMC-Q0805NPO0R8_100TRPF	0.8	A, B, C	400	0.50
NMC-Q0805NPO0R9_100TRPF	0.9	A, B, C	400	0.40
NMC-Q0805NPO1R0_100TRPF	1.0	A, B, C	400	0.30
NMC-Q0805NPO1R2_100TRPF	1.2	A, B, C	400	0.20
NMC-Q0805NPO1R5_100TRPF	1.5	A, B, C	400	0.20
NMC-Q0805NPO1R6_100TRPF	1.6	A, B, C	400	0.20
NMC-Q0805NPO1R8_100TRPF	1.8	A, B, C	400	0.20
NMC-Q0805NPO2R0_100TRPF	2.0	A, B, C	400	0.20
NMC-Q0805NPO2R2_100TRPF	2.2	A, B, C	400	0.20
NMC-Q0805NPO2R7_100TRPF	2.7	A, B, C	400	0.15
NMC-Q0805NPO3R3_100TRPF	3.3	A, B, C	350	0.15
NMC-Q0805NPO3R9_100TRPF	3.9	A, B, C	350	0.10
NMC-Q0805NPO4R3_100TRPF	4.3	A, B, C	300	0.10
NMC-Q0805NPO4R7_100TRPF	4.7	A, B, C	300	0.10
NMC-Q0805NPO5R6_100TRPF	5.6	B, C, D	300	0.10
NMC-Q0805NPO6R8_100TRPF	6.8	B, C, D	250	0.10
NMC-Q0805NPO8R2_100TRPF	8.2	B, C, D	200	0.10
NMC-Q0805NPO100_100TRPF	10	F, G, J	150	0.10
NMC-Q0805NPO120_100TRPF	12	F, G, J	100	0.10
NMC-Q0805NPO150_100TRPF	15	F, G, J	100	0.10
NMC-Q0805NPO180_100TRPF	18	F, G, J	100	0.10
NMC-Q0805NPO220_100TRPF	22	F, G, J	100	0.10
NMC-Q0805NPO270_100TRPF	27	F, G, J	75	0.10
NMC-Q0805NPO330_100TRPF	33	F, G, J	60	0.10
NMC-Q0805NPO390_100TRPF	39	F, G, J	40	0.10
NMC-Q0805NPO430_100TRPF	43	F, G, J	25	0.10
NMC-Q0805NPO470_100TRPF	47	F, G, J	25	0.10
NMC-Q0805NPO560_100TRPF	56	F, G, J	10	0.10
NMC-Q0805NPO680_100TRPF	68	F, G, J	3	0.10
NMC-Q0805NPO820_100TRPF	82	F, G, J	3	0.10
NMC-Q0805NPO101_100TRPF	100	F, G, J	3	0.10

*Typical Q & ESR

0805 250 Volt Standard Values and Characteristics

NIC PART NUMBER	CAPACITANCE VALUE (pF)	AVAILABLE TOLERANCE	Q FACTOR (typ. @ 1GHz)*	ESR Ω (typ. @ 1GHz)*
NMC-Q0805NPO0R2_250TRPF	0.2	B	400	0.90
NMC-Q0805NPO0R3_250TRPF	0.3	B	400	0.90
NMC-Q0805NPO0R4_250TRPF	0.4	A, B	400	0.90
NMC-Q0805NPO0R5_250TRPF	0.5	A, B, C	400	0.80
NMC-Q0805NPO0R6_250TRPF	0.6	A, B, C	400	0.70
NMC-Q0805NPO0R7_250TRPF	0.7	A, B, C	400	0.50
NMC-Q0805NPO0R8_250TRPF	0.8	A, B, C	400	0.50
NMC-Q0805NPO0R9_250TRPF	0.9	A, B, C	400	0.40
NMC-Q0805NPO1R0_250TRPF	1.0	A, B, C	400	0.30
NMC-Q0805NPO1R2_250TRPF	1.2	A, B, C	400	0.20
NMC-Q0805NPO1R5_250TRPF	1.5	A, B, C	400	0.20
NMC-Q0805NPO1R6_250TRPF	1.6	A, B, C	400	0.20
NMC-Q0805NPO1R8_250TRPF	1.8	A, B, C	400	0.20
NMC-Q0805NPO2R0_250TRPF	2.0	A, B, C	400	0.20
NMC-Q0805NPO2R2_250TRPF	2.2	A, B, C	400	0.20
NMC-Q0805NPO2R7_250TRPF	2.7	A, B, C	400	0.15
NMC-Q0805NPO3R3_250TRPF	3.3	A, B, C	350	0.15
NMC-Q0805NPO3R9_250TRPF	3.9	A, B, C	350	0.10
NMC-Q0805NPO4R3_250TRPF	4.3	A, B, C	300	0.10
NMC-Q0805NPO4R7_250TRPF	4.7	A, B, C	300	0.10
NMC-Q0805NPO5R6_250TRPF	5.6	B, C, D	300	0.10
NMC-Q0805NPO6R8_250TRPF	6.8	B, C, D	250	0.10
NMC-Q0805NPO8R2_250TRPF	8.2	B, C, D	200	0.10
NMC-Q0805NPO100_250TRPF	10	F, G, J	150	0.10
NMC-Q0805NPO120_250TRPF	12	F, G, J	100	0.10
NMC-Q0805NPO150_250TRPF	15	F, G, J	100	0.10
NMC-Q0805NPO180_250TRPF	18	F, G, J	100	0.10
NMC-Q0805NPO220_250TRPF	22	F, G, J	100	0.10
NMC-Q0805NPO270_250TRPF	27	F, G, J	75	0.10
NMC-Q0805NPO330_250TRPF	33	F, G, J	60	0.10
NMC-Q0805NPO390_250TRPF	39	F, G, J	40	0.10
NMC-Q0805NPO430_250TRPF	43	F, G, J	25	0.10
NMC-Q0805NPO470_250TRPF	47	F, G, J	25	0.10
NMC-Q0805NPO560_250TRPF	56	F, G, J	10	0.10
NMC-Q0805NPO680_250TRPF	68	F, G, J	3	0.10
NMC-Q0805NPO820_250TRPF	82	F, G, J	3	0.10
NMC-Q0805NPO101_250TRPF	100	F, G, J	3	0.10

*Typical Q & ESR

0805 500 Volt Standard Values and Characteristics

NIC PART NUMBER	CAPACITANCE VALUE (pF)	AVAILABLE TOLERANCE	Q FACTOR (typ. @ 1GHz)*	ESR Ω (typ. @ 1GHz)*
NMC-Q0805NPO0R2_500TRPF	0.2	B	400	0.90
NMC-Q0805NPO0R3_500TRPF	0.3	B	400	0.90
NMC-Q0805NPO0R4_500TRPF	0.4	A, B	400	0.90
NMC-Q0805NPO0R5_500TRPF	0.5	A, B, C	400	0.80
NMC-Q0805NPO0R6_500TRPF	0.6	A, B, C	400	0.70
NMC-Q0805NPO0R7_500TRPF	0.7	A, B, C	400	0.50
NMC-Q0805NPO0R8_500TRPF	0.8	A, B, C	400	0.50
NMC-Q0805NPO0R9_500TRPF	0.9	A, B, C	400	0.40
NMC-Q0805NPO1R0_500TRPF	1.0	A, B, C	400	0.30
NMC-Q0805NPO1R2_500TRPF	1.2	A, B, C	400	0.20
NMC-Q0805NPO1R5_500TRPF	1.5	A, B, C	400	0.20
NMC-Q0805NPO1R6_500TRPF	1.6	A, B, C	400	0.20
NMC-Q0805NPO1R8_500TRPF	1.8	A, B, C	400	0.20
NMC-Q0805NPO2R0_500TRPF	2.0	A, B, C	400	0.20
NMC-Q0805NPO2R2_500TRPF	2.2	A, B, C	400	0.20
NMC-Q0805NPO2R7_500TRPF	2.7	A, B, C	400	0.15
NMC-Q0805NPO3R3_500TRPF	3.3	A, B, C	350	0.15
NMC-Q0805NPO3R9_500TRPF	3.9	A, B, C	350	0.10
NMC-Q0805NPO4R3_500TRPF	4.3	A, B, C	300	0.10
NMC-Q0805NPO4R7_500TRPF	4.7	A, B, C	300	0.10
NMC-Q0805NPO5R6_500TRPF	5.6	B, C, D	300	0.10
NMC-Q0805NPO6R8_500TRPF	6.8	B, C, D	250	0.10
NMC-Q0805NPO8R2_500TRPF	8.2	B, C, D	200	0.10
NMC-Q0805NPO100_500TRPF	10	F, G, J	150	0.10
NMC-Q0805NPO120_500TRPF	12	F, G, J	100	0.10
NMC-Q0805NPO150_500TRPF	15	F, G, J	100	0.10
NMC-Q0805NPO180_500TRPF	18	F, G, J	100	0.10
NMC-Q0805NPO220_500TRPF	22	F, G, J	100	0.10
NMC-Q0805NPO270_500TRPF	27	F, G, J	75	0.10
NMC-Q0805NPO330_500TRPF	33	F, G, J	60	0.10
NMC-Q0805NPO390_500TRPF	39	F, G, J	40	0.10
NMC-Q0805NPO430_500TRPF	43	F, G, J	25	0.10
NMC-Q0805NPO470_500TRPF	47	F, G, J	25	0.10
NMC-Q0805NPO560_500TRPF	56	F, G, J	10	0.10
NMC-Q0805NPO680_500TRPF	68	F, G, J	3	0.10

*Typical Q & ESR

Performance Curves

Link
0402 Q vs. Frequency

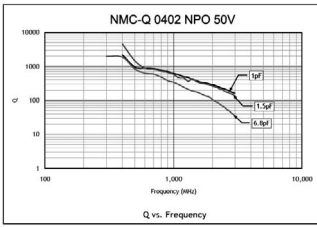

Link
0402 ESR vs. Frequency

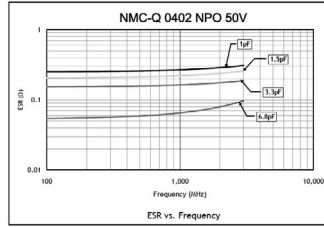

Link
0402 Impedance vs. Frequency

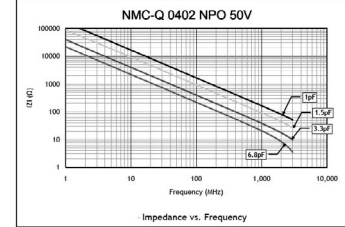

Link
0201 SRF vs. Capacitance

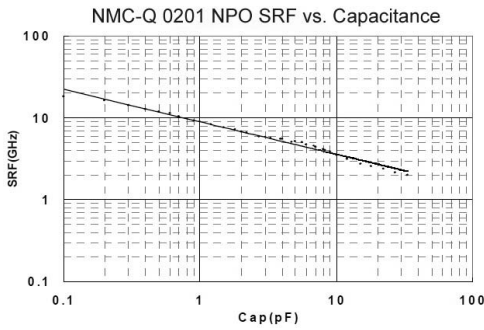

Link
0402 SRF vs. Capacitance

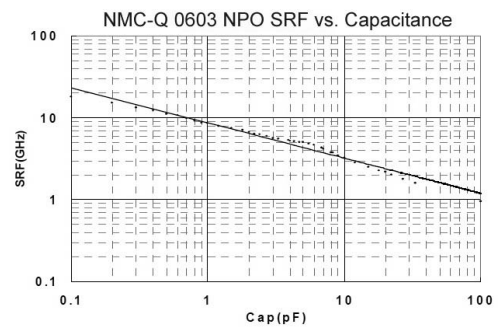

Link
0603 SRF vs. Capacitance

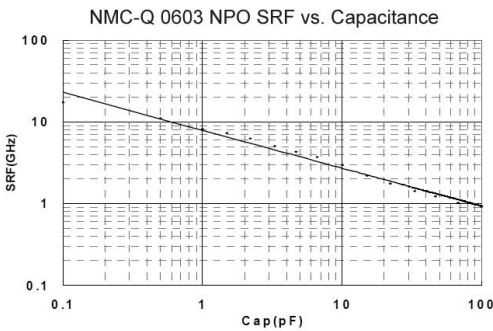

Link
0805 SRF vs. Capacitance

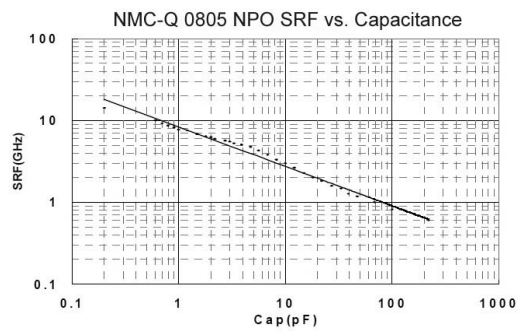

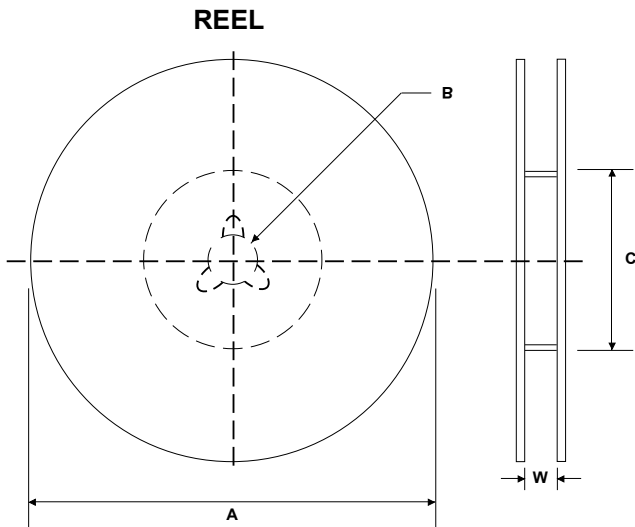

REEL DIMENSIONS (mm)

Reel Diameter (A)	B	C	W1
7" (178 ± 1.0)	13 +0.5/-0.2	60.5 ± 1.0	8.4 +1.5/-0
10" (250 ± 1.0)		100 ± 1.0	
13" (330 ± 1.0)			

REEL QUANTITIES

Size	0201	0402	0505	0603	0805
7"	15,000	10,000	3,000	4,000	4,000
10"	-	-	-	10,000	-
13"	-	50,000	10,000	15,000	15,000

PUNCHED CARRIER TAPE DIMENSIONS (mm)

Type	A ₀	B ₀	W	F	E	P0	P1	P2	D0	T
0201	0.37 ± 0.03	0.67 ± 0.03	8.00 ± 0.10	3.50 ± 0.05	1.75 ± 0.05	4.0 ± 0.10	2.0 ± 0.05	2.0 ± 0.05	1.55 ± 0.05	0.42 ± 0.30
0402	0.62 ± 0.05	1.12 ± 0.05								0.60 ± 0.05
0505	1.90 max.	1.90 max.								1.50 max.
0603	1.00 + 0.05/- 0.10	1.80 ± 0.10					0.95 ± 0.05			
0805	1.50 ± 0.10	2.30 ± 0.10								

CARDBOARD CARRIER TAPE

