

# NAZT Series

## Surface Mount Aluminum Electrolytic Capacitors



### FEATURES

- CYLINDRICAL V-CHIP CONSTRUCTION FOR SURFACE MOUNTING
- **AVAILABLE WITH ANTI-VIBRATION WIDE TERMINATIONS**
- VERY LOW IMPEDANCE & HIGH RIPPLE CURRENT AT 100KHz
- EXTENDED LOAD LIFE (2,000 ~ 5,000 HOURS @ +105°C)
- SUITABLE FOR DC-DC CONVERTER, DC-AC INVERTER, ETC.
- SAC ALLOY COMPATIBLE 230°C ~ 260°C
- DESIGNED FOR AUTOMATIC MOUNTING AND REFLOW SOLDERING
- MEETS THE REQUIREMENTS OF AEC-Q200



### CHARACTERISTICS

Rated Voltage Rating	6.3 ~ 100Vdc									
Rated Capacitance Range	4.7 ~ 12,000 $\mu$ F									
Operating Temp. Range	-55 ~ +105°C									
Capacitance Tolerance	$\pm$ 20% (M)									
Max. Leakage Current After 2 Minutes @ 20°C	0.01CV or 3 $\mu$ A whichever is greater									
Tan $\delta$ @ 120Hz/20°C	W.V. (Vdc)	6.3	10	16	25	35	50	63	80	100
	S.V. (Vdc)	8.0	13	20	32	44	63	79	100	125
	4 ~ 6.3mm diameter	0.26	0.20	0.16	0.14	0.12	0.12	0.08	-	-
	8 ~ 18mm diameter	0.28	0.24	0.22	0.16	0.14	0.14	0.08	0.08	0.07
Low Temperature Stability Impedance Ratio @ 120Hz	W.V. (Vdc)	6.3	10	16	25	35	50	63	80	100
	Z-40°C/Z+20°C	3	3	3	3	3	3	2	2	2
	Z-55°C/Z+20°C	4	4	4	3	3	3	3	3	3
Load Life Test @ 105°C 4 ~ 6mm Dia. 2,000 hours 8 ~ 18mm Dia. 5,000 hours	Capacitance Change	Within $\pm$ 30% of initial measured value								
	Tan $\delta$	Less than $\pm$ 300% of the specified maximum value								
	Leakage Current	Less than the specified maximum value								

### PART NUMBER SYSTEM

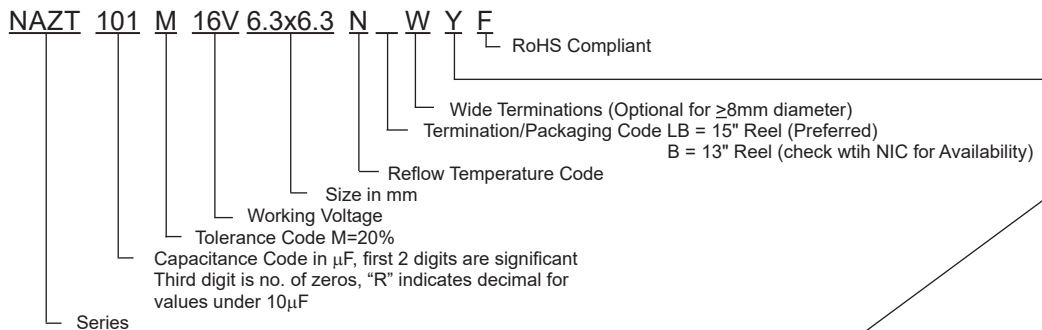

Optional: Suitable for automotive equipment, sourced to special production and inspection at IATF-16949 certified production site.

# NAZT Series

## Surface Mount Aluminum Electrolytic Capacitors



### STANDARD VALUES AND CASE SIZES (mm)

Cap. (μF)	Code	Working Voltage (Vdc)								
		6.3	10	16	25	35	50	63	80	100
4.7	4R7	-	-	-	-	4x6.3	4x6.3	-	-	-
10	100	-	-	-	4x6.3	5x6.3	6.3x6.3	6.3x6.3	-	-
15	150	-	-	4x6.3	5x6.3	5x6.3	6.3x6.3	-	-	-
22	220	-	4x6.3	5x6.3	5x6.3	5x6.3	6.3x6.3	6.3x8	-	-
27	270	4x6.3	5x6.3	5x6.3	6.3x6.3	6.3x6.3	6.3x8	-	-	-
33	330	5x6.3	5x6.3	6.3x6.3	6.3x6.3	6.3x6.3	6.3x8	-	-	10x10.5
47	470	5x6.3	6.3x6.3	6.3x6.3	6.3x6.3	6.3x6.3	6.3x8	-	10x10.5	12.5x14
56	560	5x6.3	6.3x6.3	6.3x6.3	6.3x6.3	6.3x8	8x10.5	-	-	-
68	680	6.3x6.3	6.3x6.3	6.3x6.3	6.3x6.3	6.3x8	8x10.5	-	-	12.5x14
100	101	5x6.3	6.3x6.3	6.3x6.3	6.3x8	6.3x8	8x10.5	12.5x14	12.5x14	16x17
		6.3x6.3				8x10.5				
150	151	6.3x6.3	6.3x6.3	6.3x8	8x10.5	8x10.5	10x10.5	12.5x14	12.5x14	16x17
						-				
220	221	6.3x6.3	6.3x8	6.3x8	8x10.5	8x10.5	10x10.5	12.5x14	-	18x17.5
					-					
330	331	6.3x8	8x10.5	8x10.5	8x10.5	10x10.5	12.5x14	16x17	16x17	18x22
				-						
470	471	8x10.5	8x10.5	8x10.5	10x10.5	10x14	16x17	16x17	18x17.5	-
			-			12.5x14				
680	681	8x10.5	10x10.5	10x10.5	10x14	12.5x14	16x17	18x17.5	-	-
		-			12.5x14					
1000	102	8x10.5	10x10.5	10x14	12.5x14	16x17	16x17	18x22	-	-
			12.5x14							
1200	122	-	-	-	-	-	18x17.5	-	-	-
1500	152	10x10.5	10x14	12.5x14	16x17	16x17	18x22	-	-	-
			12.5x14							
2200	222	12.5x14	12.5x14	-	16x17	18x17.5	-	-	-	-
2700	272	-	-	-	-	18x22	-	-	-	-
3300	332	-	-	16x17	18x17.5	-	-	-	-	-
3900	392	-	-	-	18x22	-	-	-	-	-
4700	472	-	16x17	18x17.5	-	-	-	-	-	-
5600	562	-	-	18x22	-	-	-	-	-	-
6800	682	16x17	18x17.5	-	-	-	-	-	-	-
8200	822	18x17.5	18x22	-	-	-	-	-	-	-
10000	103	18x17.5	-	-	-	-	-	-	-	-
12000	123	18x22	-	-	-	-	-	-	-	-

# NAZT Series

## Surface Mount Aluminum Electrolytic Capacitors



### STANDARD VALUES, CASE SIZES AND SPECIFICATIONS

NIC Part Number	Cap. (µF)	W.V. (Vdc)	Dissipation Factor (Tan δ)	Max. Impedance (Ω) 100KHz, +20°C	Max. Ripple Current (mA rms) +105°C, 100KHz	Load Life Hours @ +105°C
NAZT270M6.3V4X6.3NLBF	27	6.3	0.26	1.45	90	2,000
NAZT330M6.3V5X6.3NLBF	33		0.26	0.70	170	2,000
NAZT470M6.3V5X6.3NLBF	47		0.26	0.70	170	2,000
NAZT560M6.3V5X6.3NLBF	56		0.26	0.70	170	2,000
NAZT680M6.3V6.3X6.3NLBF	68		0.26	0.39	250	2,000
NAZT101M6.3V5X6.3NLBF	100		0.26	0.70	170	2,000
NAZT101M6.3V6.3X6.3NLBF	100		0.26	0.39	250	2,000
NAZT151M6.3V6.3X6.3NLBF	150		0.26	0.39	250	2,000
NAZT221M6.3V6.3X6.3NLBF	220		0.26	0.39	250	2,000
NAZT331M6.3V6.3X8NLBF	330		0.26	0.30	300	2,000
NAZT471M6.3V8X10.5NLBF	470		0.28	0.17	600	5,000
NAZT681M6.3V8X10.5NLBF	680		0.28	0.17	600	5,000
NAZT102M6.3V8X10.5NLBF	1000		0.28	0.17	600	5,000
NAZT152M6.3V10X10.5LLBF	1500		0.28	0.09	850	5,000
NAZT222M6.3V12.5X14KLBF	2200		0.30	0.066	1100	5,000
NAZT682M6.3V16X17JLSF	6800		0.38	0.035	1800	5,000
NAZT822M6.3V18X17.5JLSF	8200		0.42	0.033	2060	5,000
NAZT103M6.3V18X17.5JLSF	10000		0.46	0.033	2060	5,000
NAZT123M6.3V18X22JLSF	12000		0.50	0.028	2260	5,000
NAZT220M10V4X6.3NLBF	22		10	0.20	1.45	90
NAZT270M10V5X6.3NLBF	27	0.20		0.70	170	2,000
NAZT330M10V5X6.3NLBF	33	0.20		0.70	170	2,000
NAZT470M10V6.3X6.3NLBF	47	0.20		0.39	250	2,000
NAZT560M10V6.3X6.3NLBF	56	0.20		0.39	250	2,000
NAZT680M10V6.3X6.3NLBF	68	0.20		0.39	250	2,000
NAZT101M10V6.3X6.3NLBF	100	0.20		0.39	250	2,000
NAZT151M10V6.3X6.3NLBF	150	0.20		0.39	250	2,000
NAZT221M10V6.3X8NLBF	220	0.20		0.30	300	2,000
NAZT331M10V8X10.5NLBF	330	0.24		0.17	600	5,000
NAZT471M10V8X10.5NLBF	470	0.24		0.17	600	5,000
NAZT681M10V10X10.5LLBF	680	0.24		0.09	850	5,000
NAZT102M10V10X10.5LLBF	1000	0.24		0.09	850	5,000
NAZT152M10V10X14LLBF	1500	0.24		0.07	950	5,000
NAZT152M10V12.5X14KLBF	1500	0.24		0.066	1100	5,000
NAZT222M10V12.5X14KLBF	2200	0.26		0.066	1100	5,000
NAZT472M10V16X17JLSF	4700	0.30		0.035	1800	5,000
NAZT682M10V18X17.5JLSF	6800	0.34		0.033	2060	5,000
NAZT822M10V18X22JLSF	8200	0.38		0.028	2260	5,000
NAZT150M16V4X6.3NLBF	15	16		0.16	1.45	90
NAZT220M16V5X6.3NLBF	22		0.16	0.70	170	2,000
NAZT270M16V5X6.3NLBF	27		0.16	0.70	170	2,000
NAZT330M16V6.3X6.3NLBF	33		0.16	0.39	250	2,000
NAZT470M16V6.3X6.3NLBF	47		0.16	0.39	250	2,000
NAZT560M16V6.3X6.3NLBF	56		0.16	0.39	250	2,000
NAZT680M16V6.3X6.3NLBF	68		0.16	0.39	250	2,000
NAZT101M16V6.3X6.3NLBF	100		0.16	0.39	250	2,000
NAZT151M16V6.3X8NLBF	150		0.16	0.30	300	2,000
NAZT221M16V6.3X8NLBF	220		0.16	0.30	300	2,000
NAZT331M16V8X10.5NLBF	330		0.22	0.17	600	5,000
NAZT471M16V8X10.5NLBF	470		0.22	0.17	600	5,000
NAZT681M16V10X10.5LLBF	680		0.22	0.09	850	5,000
NAZT102M16V10X14LLBF	1000		0.22	0.07	950	5,000
NAZT102M16V12.5X14KLBF	1000		0.22	0.066	1100	5,000
NAZT152M16V12.5X14KLBF	1500		0.22	0.06	1100	5,000
NAZT332M16V16X17JLSF	3300		0.26	0.035	1800	5,000
NAZT472M16V18X17.5JLSF	4700		0.28	0.033	2060	5,000
NAZT562M16V18X22JLSF	5600		0.30	0.028	2260	5,000

\*For Automotive Equipment see part number system

### Performance Passives By Design

NIC Components Corp.  
100 Baylis Road, Melville, NY 11747

# NAZT Series

## Surface Mount Aluminum Electrolytic Capacitors



### STANDARD VALUES, CASE SIZES AND SPECIFICATIONS

NIC Part Number	Cap. (µF)	W.V. (Vdc)	Dissipation Factor (Tan δ)	Max. Impedance (Ω) 100KHz, +20°C	Max. Ripple Current (mA rms) +105°C, 100KHz	Load Life Hours @ +105°C	
NAZT100M25V4X6.3NLBF	10	25	0.14	1.45	90	2,000	
NAZT150M25V5X6.3NLBF	15		0.14	0.70	170	2,000	
NAZT220M25V5X6.3NLBF	22		0.14	0.70	170	2,000	
NAZT270M25V6.3X6.3NLBF	27		0.14	0.39	250	2,000	
NAZT330M25V6.3X6.3NLBF	33		0.14	0.39	250	2,000	
NAZT470M25V6.3X6.3NLBF	47		0.14	0.39	250	2,000	
NAZT560M25V6.3X6.3NLBF	56		0.14	0.39	250	2,000	
NAZT680M25V6.3X6.3NLBF	68		0.14	0.39	250	2,000	
NAZT101M25V6.3X8NLBF	100		0.14	0.30	300	2,000	
NAZT151M25V8X10.5NLBF	150		0.16	0.17	600	5,000	
NAZT221M25V8X10.5NLBF	220		0.16	0.17	600	5,000	
NAZT331M25V8X10.5NLBF	330		0.16	0.17	600	5,000	
NAZT471M25V10X10.5LLBF	470		0.16	0.09	850	5,000	
NAZT681M25V10X14LLBF	680		0.16	0.07	950	5,000	
NAZT681M25V12.5X14KLBF	680		0.16	0.066	1100	5,000	
NAZT102M25V12.5X14KLBF	1000		0.16	0.066	1100	5,000	
NAZT152M25V16X17JLSF	1500		0.16	0.035	1800	5,000	
NAZT222M25V16X17JLSF	2200		0.18	0.035	1800	5,000	
NAZT332M25V18X17.5JLSF	3300		0.20	0.033	2060	5,000	
NAZT392M25V18X22JLSF	3900		0.20	0.028	2260	5,000	
NAZT4R7M35V4X6.3NLBF	4.7		35	0.12	1.45	90	2,000
NAZT100M35V5X6.3NLBF	10			0.12	0.70	170	2,000
NAZT150M35V5X6.3NLBF	15			0.12	0.70	170	2,000
NAZT220M35V5X6.3NLBF	22			0.12	0.70	170	2,000
NAZT270M35V6.3X6.3NLBF	27			0.12	0.39	250	2,000
NAZT330M35V6.3X6.3NLBF	33	0.12		0.39	250	2,000	
NAZT470M35V6.3X6.3NLBF	47	0.12		0.39	250	2,000	
NAZT560M35V6.3X8NLBF	56	0.12		0.30	300	2,000	
NAZT680M35V6.3X8NLBF	68	0.12		0.30	300	2,000	
NAZT101M35V6.3X8NLBF	100	0.12		0.30	300	2,000	
NAZT101M35V8X10.5NLBF	100	0.14		0.17	600	5,000	
NAZT151M35V8X10.5NLBF	150	0.14		0.17	600	5,000	
NAZT221M35V8X10.5NLBF	220	0.14		0.17	600	5,000	
NAZT331M35V10X10.5LLBF	330	0.14		0.09	850	5,000	
NAZT471M35V10X14LLBF	470	0.14		0.07	950	5,000	
NAZT471M35V12.5X14KLBF	470	0.14		0.066	1100	5,000	
NAZT681M35V12.5X14KLBF	680	0.14		0.066	1100	5,000	
NAZT102M35V16X17JLSF	1000	0.14		0.035	1800	5,000	
NAZT152M35V16X17JLSF	1500	0.14		0.035	1800	5,000	
NAZT222M35V18X17.5JLSF	2200	0.16		0.033	2060	5,000	
NAZT272M35V18X22JLSF	2700	0.16		0.028	2260	5,000	
NAZT4R7M50V4X6.3NLBF	4.7	50		0.12	2.90	60	2,000
NAZT100M50V6.3X6.3NLBF	10			0.12	0.88	165	2,000
NAZT150M50V6.3X6.3NLBF	15			0.12	0.88	165	2,000
NAZT220M50V6.3X6.3NLBF	22			0.12	0.88	165	2,000
NAZT270M50V6.3X8NLBF	27		0.12	0.68	195	2,000	
NAZT330M50V6.3X8NLBF	33		0.12	0.68	195	2,000	
NAZT470M50V6.3X8NLBF	47		0.12	0.68	195	2,000	
NAZT560M50V8X10.5NLBF	56		0.14	0.34	350	5,000	
NAZT680M50V8X10.5NLBF	68		0.14	0.34	350	5,000	
NAZT101M50V8X10.5NLBF	100		0.14	0.34	350	5,000	
NAZT151M50V10X10.5LLBF	150		0.14	0.18	670	5,000	
NAZT221M50V10X10.5LLBF	220		0.14	0.18	670	5,000	
NAZT331M50V12.5X14KLBF	330		0.14	0.12	900	5,000	
NAZT471M50V16X17JLSF	470		0.14	0.073	1610	5,000	
NAZT681M50V16X17JLSF	680		0.14	0.073	1610	5,000	
NAZT102M50V16X17JLSF	1000		0.14	0.073	1610	5,000	
NAZT122M50V18X17.5JLSF	1200		0.14	0.068	1900	5,000	
NAZT152M50V18X22JLSF	1500		0.14	0.042	2180	5,000	

Part Number Suffix Where \_\_ : Preferred (15" reel) = LB, Legacy (13" reel) = B (check with NIC for availability)

\*For Automotive Equipment see part number system

### Performance Passives By Design

NIC Components Corp.  
100 Baylis Road. Melville, NY 11747

# NAZT Series

## Surface Mount Aluminum Electrolytic Capacitors



### STANDARD VALUES, CASE SIZES AND SPECIFICATIONS

NIC Part Number	Cap. (μF)	W.V. (Vdc)	Dissipation Factor (Tan δ)	Max. Impedance (Ω) 100kHz, +20°C	Max. Ripple Current (mA rms) +105°C, 100kHz	Load Life Hours @ +105°C
NAZT100M63V6.3X6.3LLBF	10	63	0.08	1.50	80	2,000
NAZT220M63V6.3X8LLBF	22		0.08	1.20	120	2,000
NAZT101M63V12.5X14JLBF	100		0.08	0.16	800	5,000
NAZT151M63V12.5X14JLBF	150		0.08	0.16	800	5,000
NAZT221M63V12.5X14JLBF	220		0.08	0.16	800	5,000
NAZT331M63V16X17HLSF	330		0.08	0.082	1410	5,000
NAZT471M63V16X17HLSF	470		0.08	0.082	1410	5,000
NAZT681M63V18X17.5HLSF	680		0.08	0.080	1690	5,000
NAZT102M63V18X22HLSF	1000		0.08	0.055	1960	5,000
NAZT470M80V10X10.5JLBF	47		80	0.08	0.65	200
NAZT101M80V12.5X14HLBF	100	0.08		0.32	500	5,000
NAZT151M80V12.5X14HLBF	150	0.08		0.32	500	5,000
NAZT331M80V16X17HLSF	330	0.08		0.17	793	5,000
NAZT471M80V18X17.5HLSF	470	0.08		0.153	917	5,000
NAZT330M100V10X10.5JLBF	33	100		0.07	0.65	200
NAZT470M100V12.5X14HLBF	47		0.07	0.32	500	5,000
NAZT680M100V12.5X14HLBF	68		0.07	0.32	500	5,000
NAZT101M100V16X17HLSF	100		0.07	0.17	793	5,000
NAZT151M100V16X17HLSF	150		0.07	0.17	793	5,000
NAZT221M100V18X17.5HLSF	220		0.07	0.153	917	5,000
NAZT331M100V18X22HLSF	330		0.07	0.083	1230	5,000

\*For Automotive Equipment see part number system

### RIPPLE CURRENT FREQUENCY CORRECTION FACTORS

Frequency	100≤F<1KHz	1K≤F<10KHz	10K≤F<100KHz	100KHz≤F
C≤33μF	0.35	0.70	0.90	1.00
33μF<C≤150μF	0.40	0.85	0.92	1.00
150μF<C	0.60	0.85	0.95	1.00

### COMPONENT DIMENSIONS (mm)

Case Size	φD±0.5	L max.	A±0.2	B±0.2	I±0.3	W	P±0.3
4x6.3	4.0	6.3	4.3	4.3	1.8	0.5~0.8	1.0
5x6.3	5.0	6.3	5.3	5.3	2.2	0.5~0.8	1.4
6.3x6.3	6.3	6.3	6.6	6.6	2.5	0.5~0.8	2.2
6.3x8	6.3	8.0	6.6	6.6	2.5	0.5~0.8	2.2
8x10.5	8.0	10.5	8.3	8.3	2.9	0.7~1.1	3.2
10x10.5	10.0	10.5	10.3	10.3	3.2	0.7~1.4	4.6
10x14	10.0	14	10.3	10.3	3.2	0.7~1.4	4.6
12.5x14	12.5	14.0	12.8	12.8	4.5	1.0~1.4	4.6
16x17	16.0	17.0	16.3	16.3	5.2	1.7~2.1	7.0
18x17.5	18	17.5	19.0	19.0	6.5	1.7~2.1	7.0
18x22	18	22.0	19.0	19.0	6.5	1.7~2.1	7.0

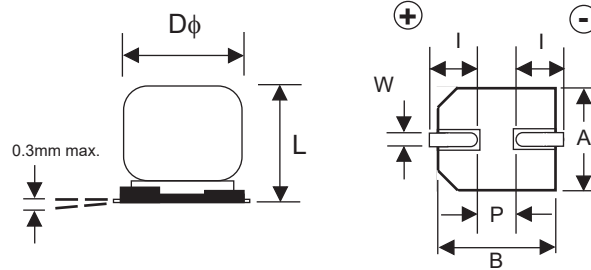

### STANDARD TERMINAL LAND PATTERN DIMENSIONS (mm)

Case Size	a	b	c
4x6.3	1.0	2.6	1.8
5x6.3	1.4	3.0	1.8
6x3x6.3 6.3x8	2.1	3.5	1.8
8x10.5	2.8	4.1	2.1
10x10.5 10x14	4.3	4.4	2.5
12.5x14	4.3	5.8	2.5
16x17	6.6	6.5	5.0
18x17.5	6.6	7.7	5.0
18x22	6.6	7.7	5.0

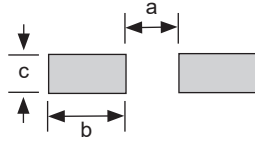

### WIDE TERMINATION (WT) DIM. (mm)

Case Size	D $\phi$ $\pm$ 0.5	L	A, B	C $\pm$ 0.2	P $\pm$ 0.2	W	R	T
8x10.5WT	8.0	10.5 $\pm$ 0.5	8.3 $\pm$ 0.2	9.0	3.2	0.7 ~ 1.0	(0.7)	(1.3)
10x10.5WT	10.0	10.5 $\pm$ 0.5	10.3 $\pm$ 0.2	11.0	4.6	1.0 ~ 1.4	(0.7)	(1.3)
10x14WT	10.0	14.0 +0.5/-1.5	10.3 $\pm$ 0.2	11.0	4.6	1.0 ~ 1.4	(0.7)	(1.3)
12.5x14WT	12.5	14.0 +0.5/-1.5	13.5 $\pm$ 0.2	14.2	4.6	1.0 ~ 1.4	(2.2)	(2.4)
16x17WT	16.0	17.0 +0.5/-1.5	17.0 $\pm$ 0.2	18.0	7.0	1.8 ~ 2.1	(3.0)	(2.0)
18x17.5WT	18.0	17.5 +0/-2.0	19.0 $\pm$ 0.2	20.0	7.0	1.7 ~ 2.1	(3.0)	(2.0)
18x22WT	18.0	22.0 +0/-2.0	19.0 $\pm$ 0.2	20.0	7.0	1.7 ~ 2.1	(3.0)	(2.0)

### WT LAND PATTERN DIM. (mm)

Case Size	a	b	c
8x10.5WT	2.5	4.5	4.7
10x10.5WT	3.8	4.8	4.7
10x10.5WT	3.8	4.8	4.7
10x14WT	3.8	4.8	4.7
12.5x14WT	3.8	6.1	6.9
16x17WT	5.0	8.0	9.5
18x17.5WT	5.0	8.6	9.5
18x22WT	5.0	8.6	9.5

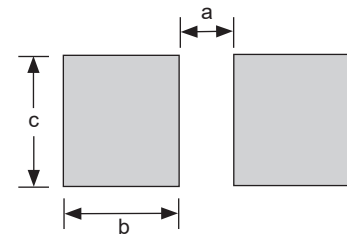
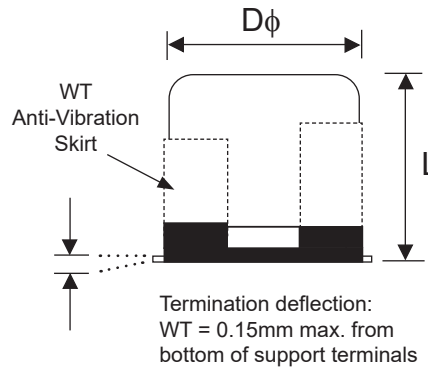
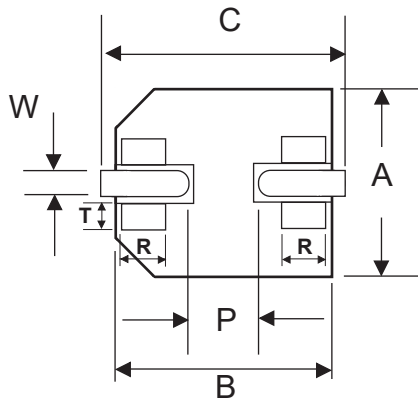

Review & Compare Reflow Soldering Heat Limits  
V-chip SMT Aluminum Electrolytic Capacitors  
[www.niccomp.com/RSL](http://www.niccomp.com/RSL)

# NAZT Series

## Surface Mount Aluminum Electrolytic Capacitors



### REFLOW TEMPERATURES AND DURATIONS

Voltage	Diameter	Time above 200°C	Time above 217°C	Time above 230°C	Peak Temperature 5 seconds
6.3 ~ 50V	4 ~ 8mm $\phi$	80 sec. max.	70 sec. max.	40 sec. max.	260°C
	10mm $\phi$	70 sec. max.	60 sec. max.	40 sec. max.	250°C
	12.5mm $\phi$	60 sec. max.	50 sec. max.	30 sec. max.	245°C
	16 ~ 18mm $\phi$	50 sec. max.	40 sec. max.	20 sec. max.	240°C
	Optional: 1 Time Reflow only 16 ~ 18mm $\phi$	100 sec. max.	80 sec. max.	30 sec. max.	245°C
63V	6.3mm $\phi$	70 sec. max.	60 sec. max.	40 sec. max.	250°C
	10 ~ 12.5mm $\phi$	50 sec. max.	40 sec. max.	20 sec. max.	240°C
	16 ~ 18mm $\phi$	50 sec. max.	40 sec. max.	15 sec. max.	235°C
80V	10mm $\phi$	50 sec. max.	40 sec. max.	20 sec. max.	240°C
	12.5mm $\phi$	50 sec. max.	40 sec. max.	20 sec. max.	235°C
	16 ~ 18mm $\phi$	45 sec. max.	30 sec. max.	10 sec. max.	235°C
100V	10mm $\phi$	50 sec. max.	40 sec. max.	20 sec. max.	240°C
	12.5mm $\phi$	50 sec. max.	40 sec. max.	20 sec. max.	235°C
	Optional: 1 Time Reflow only 12.5mm $\phi$	50 sec. max.	30 sec. max.	20 sec. max.	245°C
	16 ~ 18mm $\phi$	45 sec. max.	30 sec. max.	10 sec. max.	235°C

### PEAK REFLOW TEMPERATURE CODES

Code	Peak Reflow Temperature
N	260°C
L	250°C
K	245°C
J	240°C
H	235°C

### TERMINATION FINISH & PACKAGING OPTIONS CODES

Code	Finish & Reel Size
LB	Sn-Bi Finish & 15" Reel
LS	100% Sn Finish & 15" Reel

Note: 16mm & 18mm diameter parts are only available with Sn finish.

Capacitors can withstand two times reflow at the above conditions. Second reflow shall be at least one hour after natural cool to room temperature.

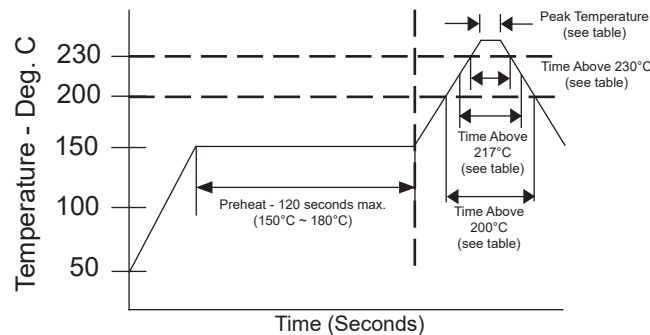

### PRECAUTIONS

Please review the notes on correct use, safety and precautions found at <https://www.niccomp.com/resource/files/aluminum/AlumApplInfoCautions.pdf>. If in doubt or uncertainty, please review your specific application - process details with NIC's technical support personnel: [tpmg@niccomp.com](mailto:tpmg@niccomp.com)

# NAZT Series

## Surface Mount Aluminum Electrolytic Capacitors



### WT (Wide Terminations) Anti-Vibration Test

Test Method	Direction: X, Y, Z axis
	Frequency & Duration: 5 to 2000Hz reciprocation for 20 minutes, 2 hours each direction
	Peak to Peak Amplitude: 5mm
	Peak Acceleration: 30G
	Sweep Type: Log
Δ Capacitance	Within ± 10% of initial value
Tangent of Loss	≤ Specified value
Leakage Current	≤ Specified value

### TAPING SPECIFICATIONS (mm)

- Both Leader and Trailer tape: Minimum 10 empty carrier tape pockets.
- Connection: Maximum 3 connections (slices) per reel.

Case Size	A ±0.2	B ±0.2	C ±0.3	D ±0.1	P ±0.1	T ±0.2	t max.	S ±0.1
4x6.3	4.7	4.7	12.0	5.5	8.0	6.4	0.6	-
5x6.3	5.7	5.7	12.0	5.5	12.0	6.4	0.6	-
6.3x6.3	7.0	7.0	16.0	7.5	12.0	6.5	0.6	-
6.3x8	7.0	7.0	16.0	7.5	12.0	8.2	0.6	-
8x10.5	8.7	8.7	24.0	11.5	16.0	11.1	0.6	-
10x10.5	10.7	10.7	24.0	11.5	16.0	11.2	0.6	-
10x14	10.7	10.7	24.0	11.5	16.0	14.6	0.6	-
12.5x14	13.2	13.2	32.0	14.2	24.0	14.3	0.6	28.4
16x17	17.5	17.5	44.0	20.2	28.0	17.3	0.6	40.4
18x17	19.5	19.5	44.0	20.2	32.0	17.8	0.6	40.4
18x22	19.5	19.5	44.0	20.2	32.0	22.5	0.6	40.4

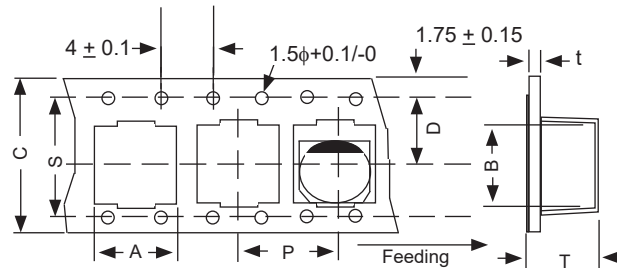

### WT TAPING SPECIFICATIONS (mm)

- Both Leader and Trailer tape: Minimum 10 empty carrier tape pockets.
- Connection: Maximum 3 connections (slices) per reel.

Case Size	A ±0.2	B ±0.2	C ±0.3	D ±0.1	P ±0.1	T ±0.2	t max.	S ±0.1
8x10.5	8.7	8.7	24.0	11.5	16.0	11.1	0.6	-
10x10.5	10.7	10.7	24.0	11.5	16.0	11.2	0.6	-
10x14	10.7	10.7	24.0	11.5	16.0	14.6	0.6	-
12.5x14	13.9	13.9	32.0	14.2	24.0	14.7	0.6	28.4
16x17	17.5	17.5	44.0	20.2	28.0	17.8	0.6	40.4
18x17	19.5	19.5	44.0	20.2	32.0	17.8	0.6	40.4
18x22	19.5	19.5	44.0	20.2	32.0	22.5	0.6	40.4

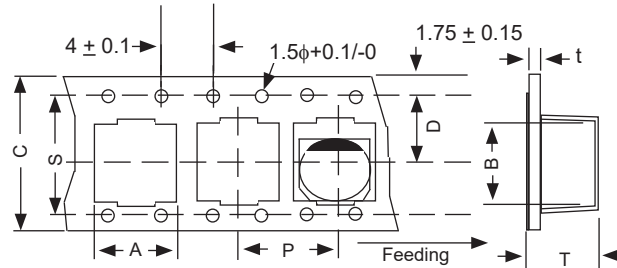



### V-Chip 15" (380mm) Reels (LB suffix)

#### Dimensions (mm)

Case Size	Tape Width	W1	W2
4x6.3, 5x6.3	12.0	12.5 ~ 14.0	15.5 ~ 20.0
6.3x6.3, 6.3x8	16.0	16.5 ~ 18.0	19.5 ~ 24.0
8x10.5, 10x10.5, 10x14	24.0	24.5 ~ 26.0	27.5 ~ 32.0
12.5x14	32.0	33.0 ~ 34.0	36.5 ~ 38.5
16x17, 18x17, 18x22	44.0	45.0 ~ 46.0	48.5 ~ 50.5

Case Size	Tape Width	A	B	C	D	E
4x6.3, 5x6.3	12.0	φ380 ±2	φ80~105	φ13 ±0.5	φ21 ±1.0	2.0 ±0.5
6.3x6.3, 6.3x8	16.0					
8x10.5, 10x10.5, 10x14	24.0					
12.5x14	32.0					
16x17, 18x17, 18x22	44.0					

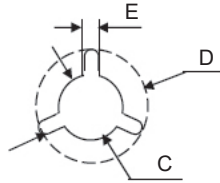
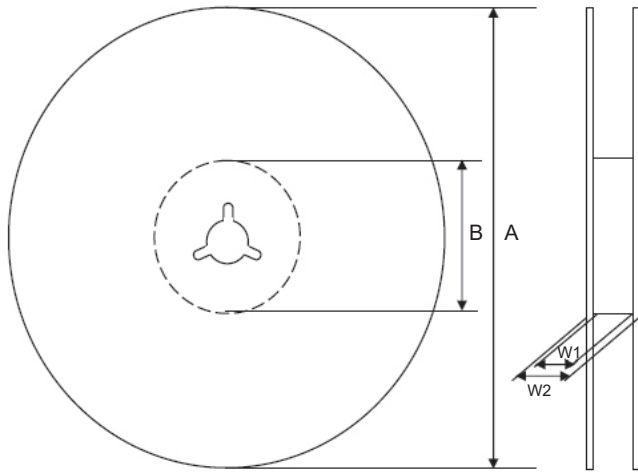

Case Size	Quantity per Reel
	15" (380mm)
4x6.3	2000
5x6.3	1000
6.3x6.3	1000
6.3x8	900
8x10.5	500
10x10.5	500
10x14	400
12.5x14	250
16x17	200
18x17	175
18x22	125