

Single-pole Illuminated Rocker Switch

Q-156

TYPE: **IRS-1E-2C**

SPECIFICATIONS

Contact Type: SPST
 Rating: 10A 250V AC
 Contact R: 35mΩ max
 Insulation R: 500V DC 100MΩ min
 Dielectric Strength: 1 Minute 1500V AC
 Operating Temperature: -25°C ~ +85°C
 Electrical Life: 10, 000 Cycles

Outline Drawing

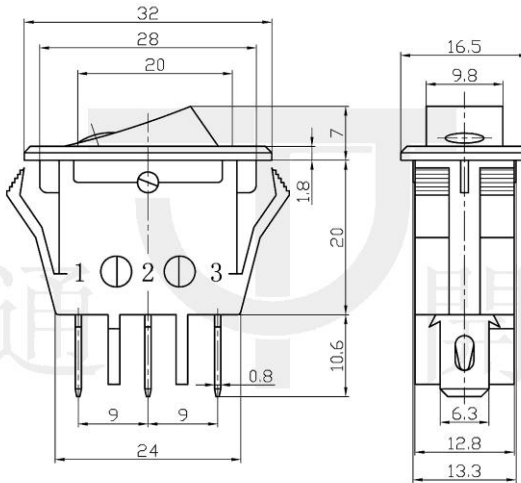

Mounting

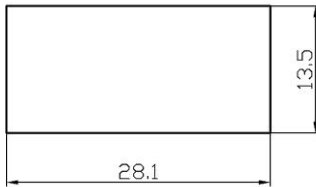

Circuitry

