

# BSS63LT1G, NSVBSS63LT1G

## High Voltage Transistor

### PNP Silicon

#### Features

- NSV Prefix for Automotive and Other Applications Requiring Unique Site and Control Change Requirements; AEC-Q101 Qualified and PPAP Capable
- These Devices are Pb-Free, Halogen Free/BFR Free and are RoHS Compliant

#### MAXIMUM RATINGS

Rating	Symbol	Value	Unit
Collector-Emitter Voltage	$V_{CEO}$	-100	Vdc
Collector-Emitter Voltage $R_{BE} = 10\text{ k}\Omega$	$V_{CER}$	-110	Vdc
Collector Current - Continuous	$I_C$	-100	mAdc

#### THERMAL CHARACTERISTICS

Characteristic	Symbol	Max	Unit
Total Device Dissipation FR-5 Board, (Note 1) $T_A = 25^\circ\text{C}$ Derate above $25^\circ\text{C}$	$P_D$	225 1.8	mW mW/ $^\circ\text{C}$
Thermal Resistance Junction-to-Ambient	$R_{\theta JA}$	556	$^\circ\text{C}/\text{W}$
Total Device Dissipation Alumina Substrate, (Note 2) $T_A = 25^\circ\text{C}$ Derate above $25^\circ\text{C}$	$P_D$	300 2.4	mW mW/ $^\circ\text{C}$
Thermal Resistance, Junction-to-Ambient	$R_{\theta JA}$	417	$^\circ\text{C}/\text{W}$
Junction and Storage Temperature	$T_J, T_{stg}$	-55 to +150	$^\circ\text{C}$

Stresses exceeding those listed in the Maximum Ratings table may damage the device. If any of these limits are exceeded, device functionality should not be assumed, damage may occur and reliability may be affected.

1. FR-5 = 1.0 x 0.75 x 0.062 in.
2. Alumina = 0.4 x 0.3 x 0.024 in. 99.5% alumina.



ON Semiconductor®

[www.onsemi.com](http://www.onsemi.com)

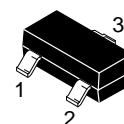
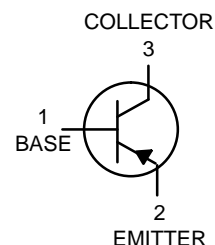

SOT-23  
CASE 318  
STYLE 6

#### MARKING DIAGRAM

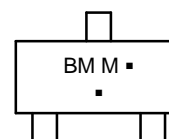

BM = Device Code  
M = Date Code\*  
▪ = Pb-Free Package

(Note: Microdot may be in either location)

\*Date Code orientation and/or overbar may vary depending upon manufacturing location.

#### ORDERING INFORMATION

Device	Package	Shipping†
BSS63LT1G	SOT-23 (Pb-free)	3000 / Tape & Reel
NSVBSS63LT1G	SOT-23 (Pb-free)	3000 / Tape & Reel

†For information on tape and reel specifications, including part orientation and tape sizes, please refer to our Tape and Reel Packaging Specifications Brochure, BRD8011/D.

# BSS63LT1G, NSVBSS63LT1G

## ELECTRICAL CHARACTERISTICS ( $T_A = 25^\circ\text{C}$ unless otherwise noted)

Characteristic	Symbol	Min	Typ	Max	Unit
<b>OFF CHARACTERISTICS</b>					
Collector–Emitter Breakdown Voltage ( $I_C = -100\ \mu\text{Adc}$ )	$V_{(BR)CEO}$	-100	-	-	Vdc
Collector–Emitter Breakdown Voltage ( $I_C = -10\ \mu\text{Adc}$ , $I_E = 0$ , $R_{BE} = 10\ \text{k}\Omega$ )	$V_{(BR)CER}$	-110	-	-	Vdc
Collector–Base Breakdown Voltage ( $I_E = -10\ \mu\text{Adc}$ , $I_C = 0$ )	$V_{(BR)CBO}$	-110	-	-	Vdc
Emitter–Base Breakdown Voltage ( $I_E = -10\ \mu\text{Adc}$ )	$V_{(BR)EBO}$	-6.0	-	-	Vdc
Collector Cutoff Current ( $V_{CB} = -90\ \text{Vdc}$ , $I_E = 0$ )	$I_{CBO}$	-	-	-100	nAdc
Collector Cutoff Current ( $V_{CE} = -110\ \text{Vdc}$ , $R_{BE} = 10\ \text{k}\Omega$ )	$I_{CER}$	-	-	-10	$\mu\text{Adc}$
Emitter Cutoff Current ( $V_{EB} = -6.0\ \text{Vdc}$ , $I_C = 0$ )	$I_{EBO}$	-	-	-200	nAdc

## ON CHARACTERISTICS

DC Current Gain ( $I_C = -10\ \text{mAdc}$ , $V_{CE} = -1.0\ \text{Vdc}$ ) ( $I_C = -25\ \text{mAdc}$ , $V_{CE} = -1.0\ \text{Vdc}$ )	$h_{FE}$	30 30	- -	- -	-
Collector–Emitter Saturation Voltage ( $I_C = -25\ \text{mAdc}$ , $I_B = -2.5\ \text{mAdc}$ )	$V_{CE(sat)}$	-	-	-250	mVdc
Base–Emitter Saturation Voltage ( $I_C = -25\ \text{mAdc}$ , $I_B = -2.5\ \text{mAdc}$ )	$V_{BE(sat)}$	-	-	-900	mVdc

## SMALL–SIGNAL CHARACTERISTICS

Current–Gain – Bandwidth Product ( $I_C = -25\ \text{mAdc}$ , $V_{CE} = -5.0\ \text{Vdc}$ , $f = 20\ \text{MHz}$ )	$f_T$	50	95	-	MHz
Case Capacitance ( $I_E = I_C = 0$ , $V_{CB} = -10\ \text{Vdc}$ , $f = 1.0\ \text{MHz}$ )	$C_C$	-	-	20	pF
Noise Figure ( $I_C = -0.2\ \text{mA}$ , $V_{CE} = -5.0\ \text{Vdc}$ , $R_g = 2\ \text{k}\Omega$ , $f = 1.0\ \text{kHz}$ , $BW = 200\ \text{Hz}$ )	NF	-	-	10	dB

Product parametric performance is indicated in the Electrical Characteristics for the listed test conditions, unless otherwise noted. Product performance may not be indicated by the Electrical Characteristics if operated under different conditions.

- FR-5 =  $1.0 \times 0.75 \times 0.062$  in.
- Alumina =  $0.4 \times 0.3 \times 0.024$  in. 99.5% alumina.

# BSS63LT1G, NSVBSS63LT1G

## TYPICAL CHARACTERISTICS

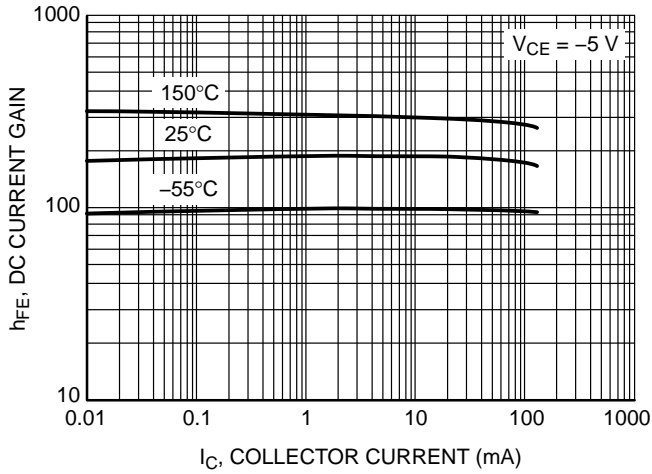

Figure 1. DC Current Gain

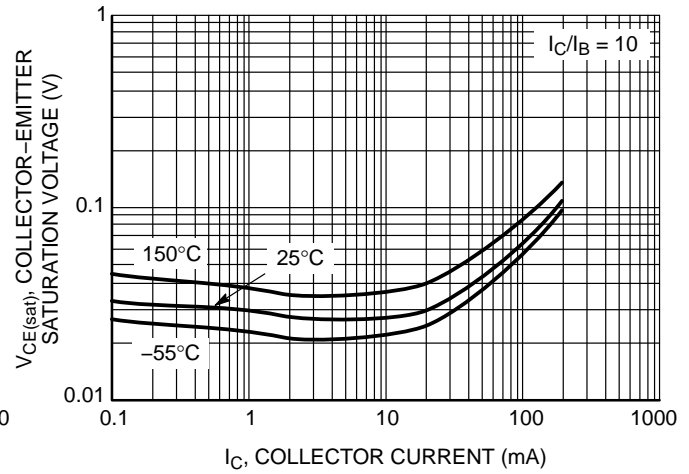

Figure 2. Collector-Emitter Saturation Voltage vs. Collector Current

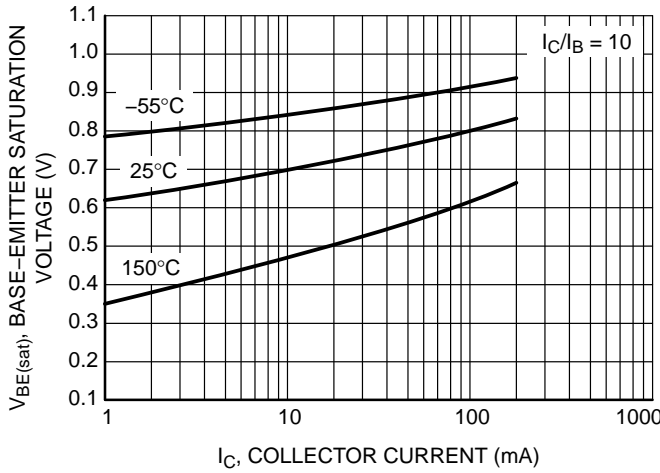

Figure 3. Base-Emitter Saturation Voltage vs. Collector Current

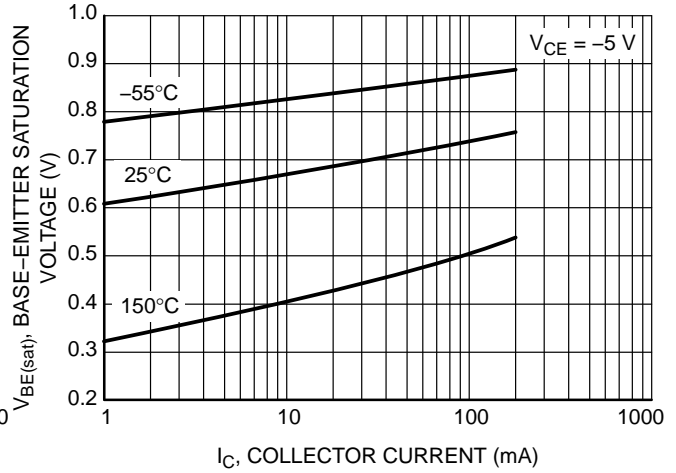

Figure 4. Base-Emitter Voltage vs. Collector Current

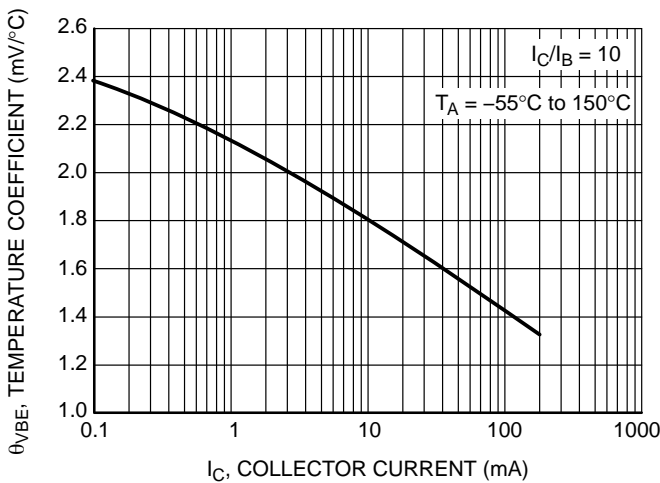

Figure 5. Base-Emitter Temperature Coefficient

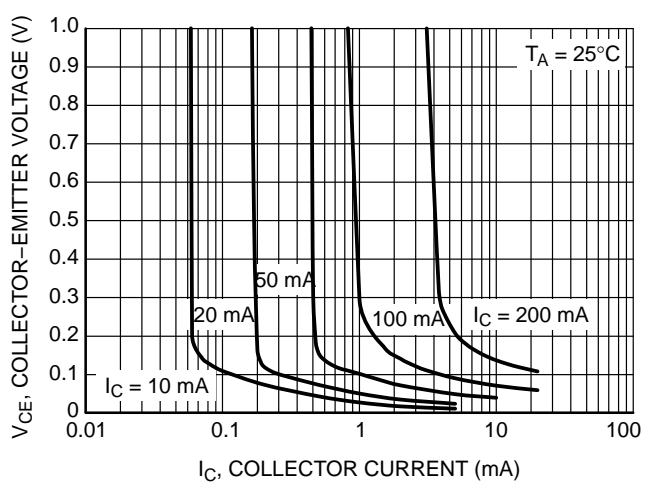

Figure 6. Collector Saturation Region

# BSS63LT1G, NSVBSS63LT1G

## TYPICAL CHARACTERISTICS

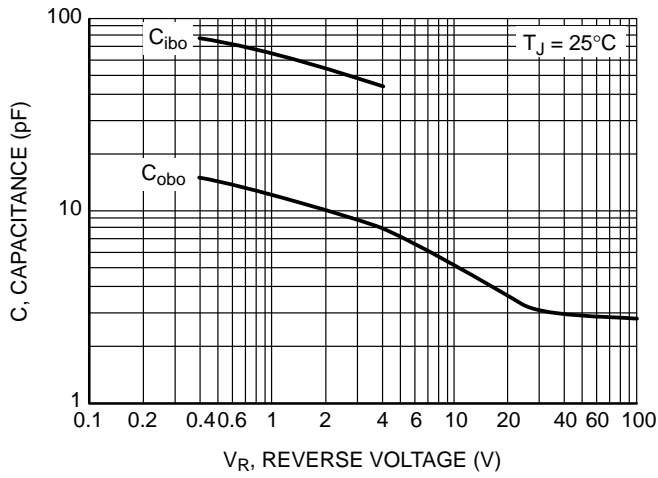

Figure 7. Capacitance

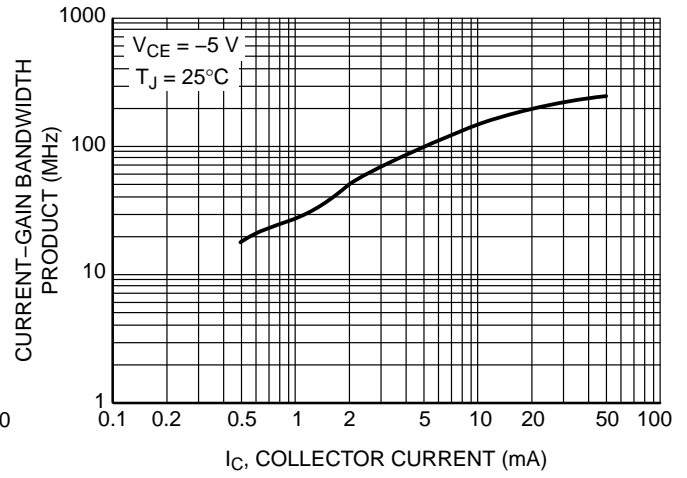

Figure 8. Current-Gain Bandwidth Product

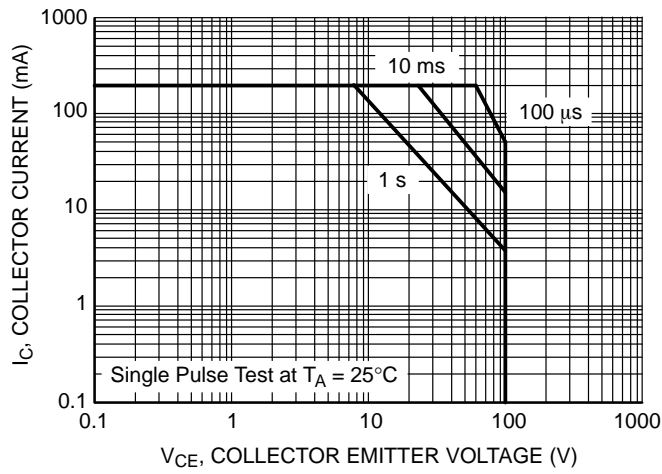
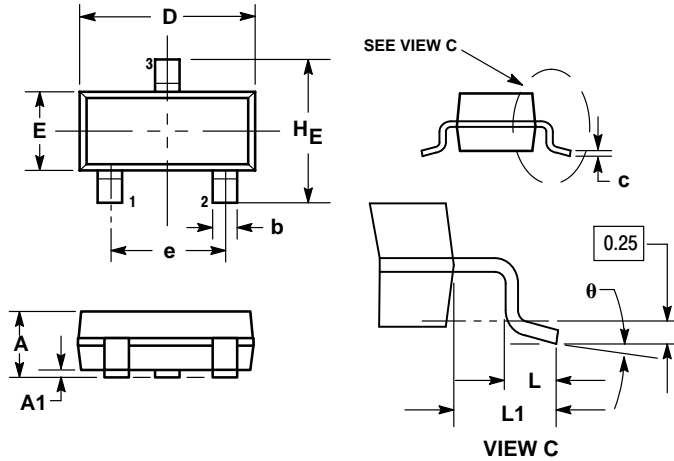

Figure 9. Safe Operating Area

# BSS63LT1G, NSVBSS63LT1G

## PACKAGE DIMENSIONS

SOT-23 (TO-236)  
CASE 318-08  
ISSUE AP



NOTES:

1. DIMENSIONING AND TOLERANCING PER ANSI Y14.5M, 1982.
2. CONTROLLING DIMENSION: INCH.
3. MAXIMUM LEAD THICKNESS INCLUDES LEAD FINISH THICKNESS. MINIMUM LEAD THICKNESS IS THE MINIMUM THICKNESS OF BASE MATERIAL.
4. DIMENSIONS D AND E DO NOT INCLUDE MOLD FLASH, PROTRUSIONS, OR GATE BURRS.

DIM	MILLIMETERS			INCHES		
	MIN	NOM	MAX	MIN	NOM	MAX
A	0.89	1.00	1.11	0.035	0.040	0.044
A1	0.01	0.06	0.10	0.001	0.002	0.004
b	0.37	0.44	0.50	0.015	0.018	0.020
c	0.09	0.13	0.18	0.003	0.005	0.007
D	2.80	2.90	3.04	0.110	0.114	0.120
E	1.20	1.30	1.40	0.047	0.051	0.055
e	1.78	1.90	2.04	0.070	0.075	0.081
L	0.10	0.20	0.30	0.004	0.008	0.012
L1	0.35	0.54	0.69	0.014	0.021	0.029
HE	2.10	2.40	2.64	0.083	0.094	0.104
θ	0°	---	10°	0°	---	10°

STYLE 6:

1. BASE
2. EMITTER
3. COLLECTOR

### SOLDERING FOOTPRINT\*

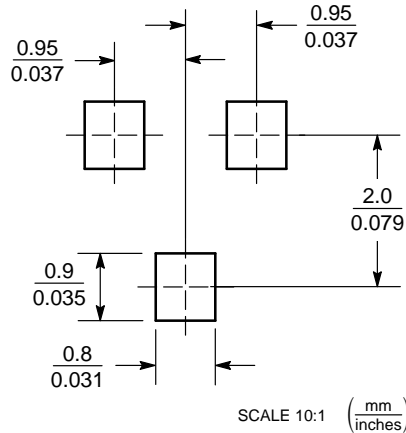

\*For additional information on our Pb-Free strategy and soldering details, please download the ON Semiconductor Soldering and Mounting Techniques Reference Manual, SOLDERRM/D.

ON Semiconductor and the  are registered trademarks of Semiconductor Components Industries, LLC (SCILLC) or its subsidiaries in the United States and/or other countries. SCILLC owns the rights to a number of patents, trademarks, copyrights, trade secrets, and other intellectual property. A listing of SCILLC's product/patent coverage may be accessed at [www.onsemi.com/site/pdf/Patent-Marketing.pdf](http://www.onsemi.com/site/pdf/Patent-Marketing.pdf). SCILLC reserves the right to make changes without further notice to any products herein. SCILLC makes no warranty, representation or guarantee regarding the suitability of its products for any particular purpose, nor does SCILLC assume any liability arising out of the application or use of any product or circuit, and specifically disclaims any and all liability, including without limitation special, consequential or incidental damages. "Typical" parameters which may be provided in SCILLC data sheets and/or specifications can and do vary in different applications and actual performance may vary over time. All operating parameters, including "Typicals" must be validated for each customer application by customer's technical experts. SCILLC does not convey any license under its patent rights nor the rights of others. SCILLC products are not designed, intended, or authorized for use as components in systems intended for surgical implant into the body, or other applications intended to support or sustain life, or for any other application in which the failure of the SCILLC product could create a situation where personal injury or death may occur. Should Buyer purchase or use SCILLC products for any such unintended or unauthorized application, Buyer shall indemnify and hold SCILLC and its officers, employees, subsidiaries, affiliates, and distributors harmless against all claims, costs, damages, and expenses, and reasonable attorney fees arising out of, directly or indirectly, any claim of personal injury or death associated with such unintended or unauthorized use, even if such claim alleges that SCILLC was negligent regarding the design or manufacture of the part. SCILLC is an Equal Opportunity/Affirmative Action Employer. This literature is subject to all applicable copyright laws and is not for resale in any manner.

### PUBLICATION ORDERING INFORMATION

LITERATURE FULFILLMENT:

Literature Distribution Center for ON Semiconductor  
19521 E. 32nd Pkwy, Aurora, Colorado 80011 USA  
Phone: 303-675-2175 or 800-344-3860 Toll Free USA/Canada  
Fax: 303-675-2176 or 800-344-3867 Toll Free USA/Canada  
Email: [orderlit@onsemi.com](mailto:orderlit@onsemi.com)

N. American Technical Support: 800-282-9855 Toll Free  
USA/Canada  
Europe, Middle East and Africa Technical Support:  
Phone: 421 33 790 2910  
Japan Customer Focus Center  
Phone: 81-3-5817-1050

ON Semiconductor Website: [www.onsemi.com](http://www.onsemi.com)

Order Literature: <http://www.onsemi.com/orderlit>

For additional information, please contact your local Sales Representative