



CONCEALED SPRINGLOADED PIN HINGES

A

12-1-3858

Stainless steel spring. Hinges in raw steel and zinc plated steel with a zinc plated pin. Circlip in 1.4122 stainless steel.

Material	304 stainless steel
Finish	raw

Note	type 2
Weight (g)	46 g
Opening angle	270 °
Functions	

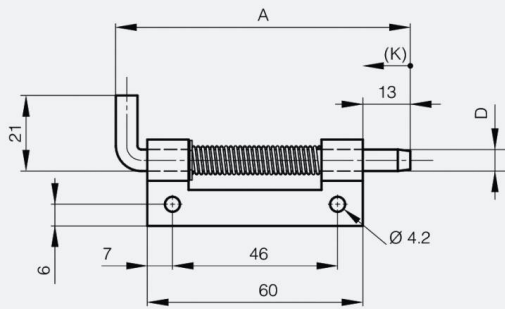

12-1-3857 & 12-1-3855 & 12-1-3859

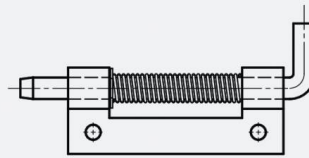

12-1-3856 & 12-1-3854 & 12-1-3858

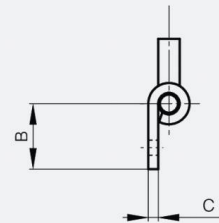

A (length)	82 mm
B (width)	18.2 mm
C	2.8 mm
D (pin diameter)	6
K	12 mm