

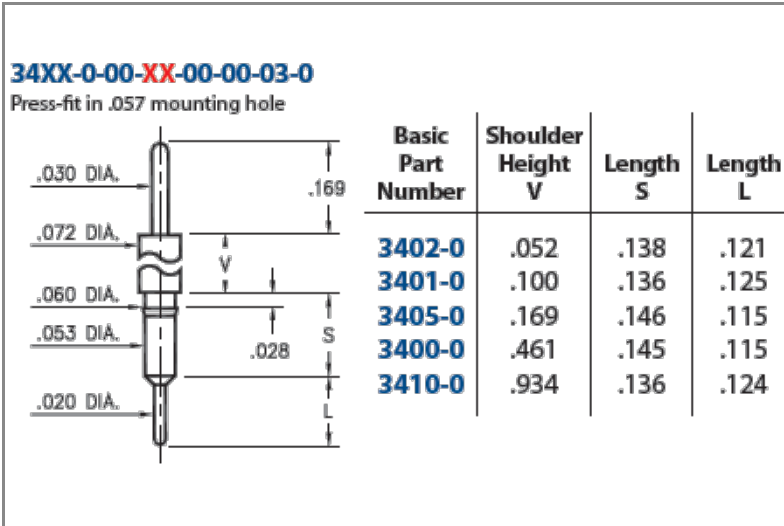

PRODUCT NUMBER: 3401-0-00-15-00-00-03-0

www.mill-max.com  
DATA SHEET



### 3401-0-00-15-00-00-03-0 SPECIFICATIONS

General Info	
<b>Description<sup>1</sup>:</b> Double Tail Header Pin	
<b>Mounting Feature:</b>	Press-Fit into a Non-Plated Through Hole (NPTH) or Insulator
<b>Mounting Hole:</b>	.057" (1,448mm)
<b>Alternate Mounting<sup>2</sup>:</b>	Through-Hole Solder Tail Mount
<b>Alternate Mounting Hole:</b>	.024" (0,610mm)
<b>Packaging:</b>	Packaged in Bulk
<b>RoHS<sup>3</sup>:</b>	Yes
<b>Product Lifecycle<sup>4</sup>:</b>	Active

Materials
<b>Shell Material<sup>5</sup>:</b> Brass Alloy
<b>Shell Plating<sup>6</sup>:</b> 10 μ" Gold over Nickel

Technical Specs	
<b>Operating Temperature Range<sup>7</sup>:</b>	-55/+125° C
<b>Current Rating<sup>8</sup>:</b>	Application Specific

## NOTES:

1. Standard Tolerances:  
Lengths +/- .005" (0,13)  
Diameters: +/- .002" (0,051)  
Angles: +/- 2°
2. For through-hole solder mounting of this part, the suggestion is to make the finished hole size, at its minimum, .004" larger than the diameter being soldered into the mounting hole.
3. Mill-Max products labeled with the RoHS symbol are compliant with all three ROHS Directives. All of our products previously described as RoHS (2002/95/EC) and RoHS-2 (2011/65/EC) are also compliant with RoHS-3 (2015/863/EU).
4. Part is Active and in Production, No Scheduled Obsolescence
5. Brass Alloy 360 per ASTM B 16, or 385 per ASTM B455
6. GOLD per ASTM B 488, Type 1 (99.7% min. gold), Code C (130-200 HK {Knoop hardness}), NICKEL per ASTM B 689, Type 2 (Bright)
7. Per IEC 60512-11-(4,-9,-10,-12)
8. Current rating is typically a measured function of the female socket/connector. The amount of current a solid, male, brass pin can tolerate is a direct relation of the heat displaced based on current and the ability of neighboring components to handle displaced heat.

## ADDITIONAL NOTES AND SPECIFICATIONS

In the interest of improved design, quality and performance , Mill-Max reserves the right to make changes in its specifications without prior notice. Specifications and tolerances are provided wherever possible. The tolerance on dimensions of critical to function features is typically held tighter than the stated standard tolerances, such as press-fits, holes and lengths affecting the coplanarity of SMT products. Due to the wide variety of interconnects Mill-Max offers, the specific tolerances vary from product to product. If you need information regarding the tolerance of a particular part, please contact Technical Services.

## RELATED LINKS AND DOCUMENTS

Environmental Compliance: ( <https://www.mill-max.com/rohs> )